

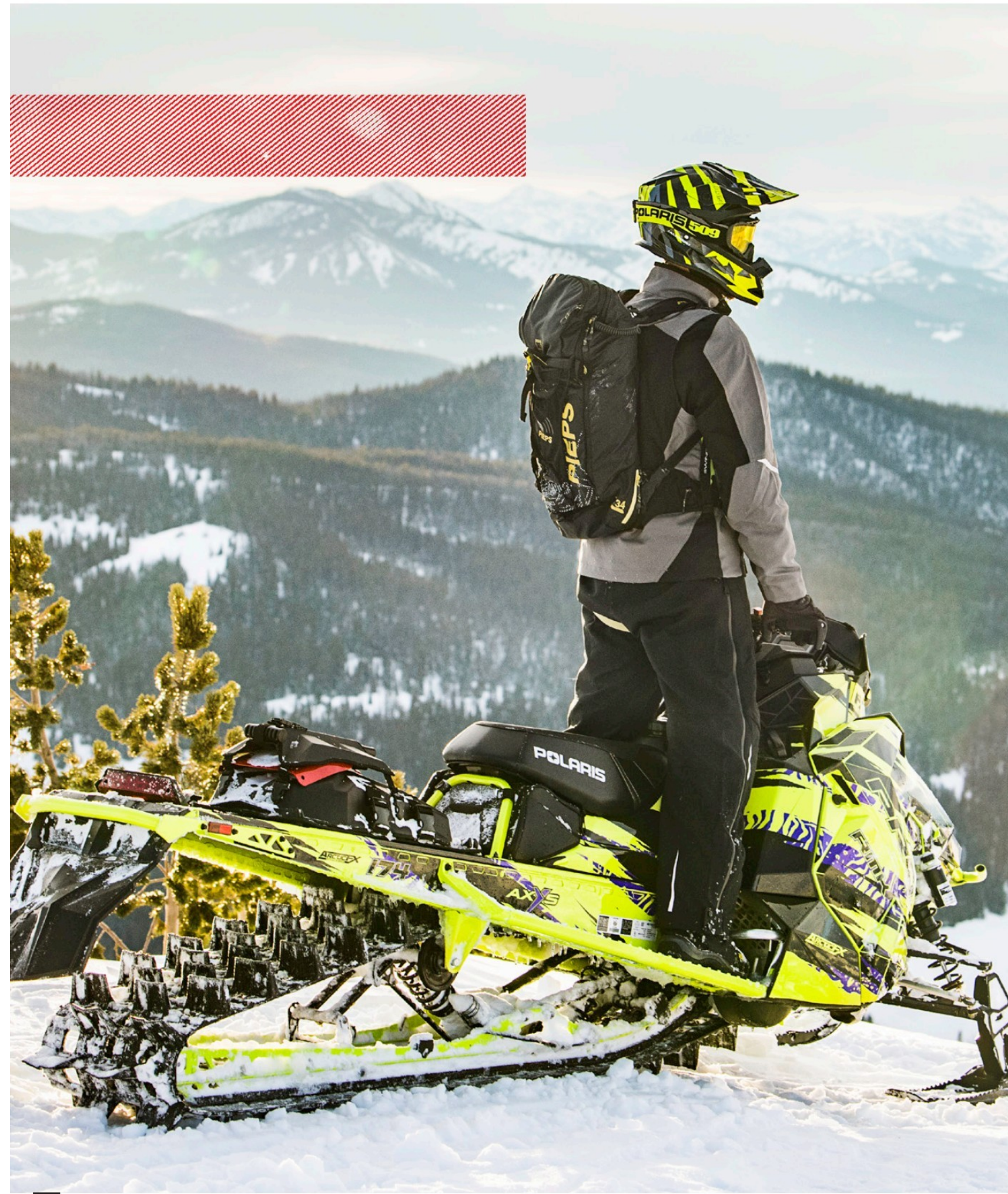

2019

[POLARISSVERIGE.COM](http://POLARISSVERIGE.COM)

ACCESSORIES & APPAREL



# 2019

## ACCESSORIES & APPAREL

# YOUR RIDE STARTS HERE

### ACCESSORIES

POLARIS ENGINEERED™	6
STORAGE & RACKS	18
HITCHES	25
SEATING	28
WINDSHIELDS	30
BUMPERS	32
RUNNING BOARDS	34
HOODS, PANELS & WRAPS	36
RIDE COMMAND® & P.I.D.D.	38
HANDLEBARS & ELECTRONICS	40
COVERS	42
TRAILERING	43
SKIS & CARBIDES	44
SHOCKS & STUDS	46
TRACKS	48

### GARAGE

BELTS, PARTS & VEHICLE CARE	50
OIL & LUBRICANTS	52

### APPAREL

MEN'S JACKETS	56
MEN'S MONOSUIT	60
MEN'S BIBS	62
MEN'S TECHNICAL WEAR	64
WOMEN'S JACKETS & TECHNICAL WEAR	66
HELMETS	68
GOGGLES	72
GLOVES	74
BOOTS	76
BEANIES	77
MEN'S SPORTSWEAR	78
CAPS & WOMEN'S SPORTSWEAR	80
YOUTH	82
OGIO® BAGS	83

Unless noted, trademarks are the property of Polaris® Industries Inc. 3M® Reflective Material, Scotchlite® and Thinsulate® are registered trademarks of 3M Corporation. 509® is a registered trademark of Teton Outfitters, LLC. AMWR® is a registered trademark of Karasoy Co., Ltd. AP-360® is a registered trademark of Stars Design Group, Inc. ArcticFX® is a registered trademark of ArcticFXGraphics LLC. BITEWARDER® is a registered trademark of Welch Manufacturing Technologies, Ltd. BOA® is a registered trademark of Boa Technology, Inc. CALIBER® is a registered trademark of Ohara Corporation. Camo is a registered trademark of Arctic Investments SA. Lycra® and ThermoLite® are registered trademarks of INVISTA North America S.A.R.L. Kevlar® is a registered trademark of E.I. du Pont de Nemours and Company. Kolpin® is a registered trademark of Polaris Industries Inc. Loctite® is a registered trademark of Henkel Corporation. Pro Taper® is a registered trademark of Lacy Distribution, Inc. QWICK-DRY® is a registered trademark of Innovative Fashion Group Corp. FOX® is a registered trademark of FOX Racing Shoes. GORE-TEX® and GUARANTEED TO KEEP YOU DRY® are registered trademarks of W. L. Gore & Associates, Inc. OGIO® is a registered trademark of Ogio International, Inc. Snoburje® is a registered trademark of Snoburje, Inc. Rox® is a registered trademark of Rox® Speed FX Inc. Taslan® is a registered trademark of Heberlein Maschinenfabrik AG. Snel® is a registered trademark of Snel® Memorial Foundation, Inc. Tekvest® is a registered trademark of Tekrider. Tuflok® is a registered trademark of Illinois Tool Works Inc. Velcro® is a registered trademark of Velcro Industries, B.V. Walker Evans® is a registered trademark of Walker Evans Enterprises Corp. Woody® and Traction Master® are registered trademarks of International Engineering and Manufacturing, Inc. Bluetooth® is a registered trademark of Bluetooth Sig, Inc. Aquaguard®, Vislon® and YKK® are registered trademarks of YKK Corporation. Zylex® is a registered trademark of Genfoot, Inc. All worldwide rights reserved. Other trademarks used in this catalog are owned by their respective owners. Oil & Lubricants section is available in Europe. Contact your local dealer for availability. Not all apparel items are available in all countries; contact your local dealer. Check with your local dealer for availability in your market and additional information. © 2018 Polaris® Industries, Inc.

# POLARIS® SNOWMOBILES



## RMK®

LIGHTEST. STRONGEST.  
MOST FLICKABLE.



## SWITCHBACK®

SMOOTHEST RIDING.  
MOST VERSATILE.



## RUSH®

SHARPEST HANDLING.  
QUICKEST ACCELERATING.



## POLARIS® TITAN™

UNMATCHED CAPABILITY.  
UNCOMPROMISING PERFORMANCE.



## INDY®

LEGENDARY PERFORMANCE.  
SIMPLY FUN.



## VOYAGEUR®

LIMITLESS  
POSSIBILITIES.



## KNOW YOUR CHASSIS FOR THE PERFECT FIT

Depending on the model of snowmobile you have and the model year, you may have either a Pro-Ride® chassis or an AXYS® chassis. Please consult the chart below to determine which chassis you have and order accordingly.

	PRO-RMK®, RMK® Assault®, SKS	Switchback® Assault® 144 & RMK® 144	Switchback®	Switchback® SP	Rush®	Polaris® Titan™	Indy® 600 & 800	600 Voyageur®
<b>AXYS®</b>	MY16-MY19	MY17-19	MY15-MY19	MY17-MY19	MY15-MY19	MY18-19		MY17-19
<b>PRO-RIDE®</b>	MY11-MY15	MY11-MY16	MY10-MY14		MY10-MY14		MY13-MY19	MY14-MY16

# RIDE-DEFINING ACCESSORIES



550 Indy<sup>®</sup>  
121"-144"

All 550  
Voyageur<sup>®</sup>

550 Indy<sup>®</sup>  
LXT, Indy<sup>®</sup>  
Adventures

129 XC  
Indy<sup>®</sup>

Indy EVO<sup>™</sup>

MY19

MY13-MY19

MY13-MY19

MY13-MY19

MY19

# POLARIS®

ENGINEERED PARTS  
ACCESSORIES & APPAREL

HANDLEBARS

P. 40

# ENGINEER A MORE PERFECT RIDE

Polaris Engineered Accessories™ are the only accessories engineered and designed exclusively with your sled. That's why every accessory fits perfectly, is covered by your factory warranty and is tested, trusted, and proven to make your next ride an even better one. Whether that's more comfort, personal style, control, storage, or more peace of mind, only Polaris Engineered Accessories guarantee the ultimate ride experience.

## WHEN ONLY THE VERY BEST WILL DO:

- PERFECT FIT
- SEAMLESS INTEGRATION
- FACTORY COLOR MATCHING
- LIMITLESS COMBINATIONS

STORAGE

P. 18

RUNNING BOARDS

P. 34

## POLARIS® PARTNERS WITH THE BEST

We choose our partners carefully, selecting only the best in snowmobiling. Every accessory is rigorously tested and validated by Polaris® standards to ensure seamless integration.



CALIBER™ P. 43

WINDSHIELDS  
P. 30

BUMPERS  
P. 32

SKIS  
P. 44

SEATING  
P. 28



**LOCK & RIDE**

**EASY ON &  
EASY OFF.**

Items with the Lock & Ride® logo feature our exclusive easy-on, easy-off installation technology. Engineer the perfect ride with accessories like storage racks or passenger seats quickly and efficiently without tools. And when you don't need them, removal is simple.



ARCTICFX® P. 37



CAMSO® P. 48



ÖHLINS® P. 46



WOODY'S® P. 46 & 47



P.18 STORAGE



## MADE FOR THE MOUNTAIN

Make discovering impossible places possible. Set the high mark or float your line effortlessly with high-performance accessories engineered to add comfort, versatility, and custom style to your RMK®.



P.28 SEATING



# PRO



**P.30** WINDSHIELDS



**P.32** PROTECTION



P.18 STORAGE



P.28 SEATING





P.30 WINDSHIELDS



P.32 PROTECTION



## THE WORLD'S YOUR PLAYGROUND

Discover a life on and off the beaten path. From a 2-up seat to added storage and more, build up your Switchback® and make it the crossover to envy in your riding group.

# RUSH<sup>®</sup>



**P.18** STORAGE



**P.28** SEATING

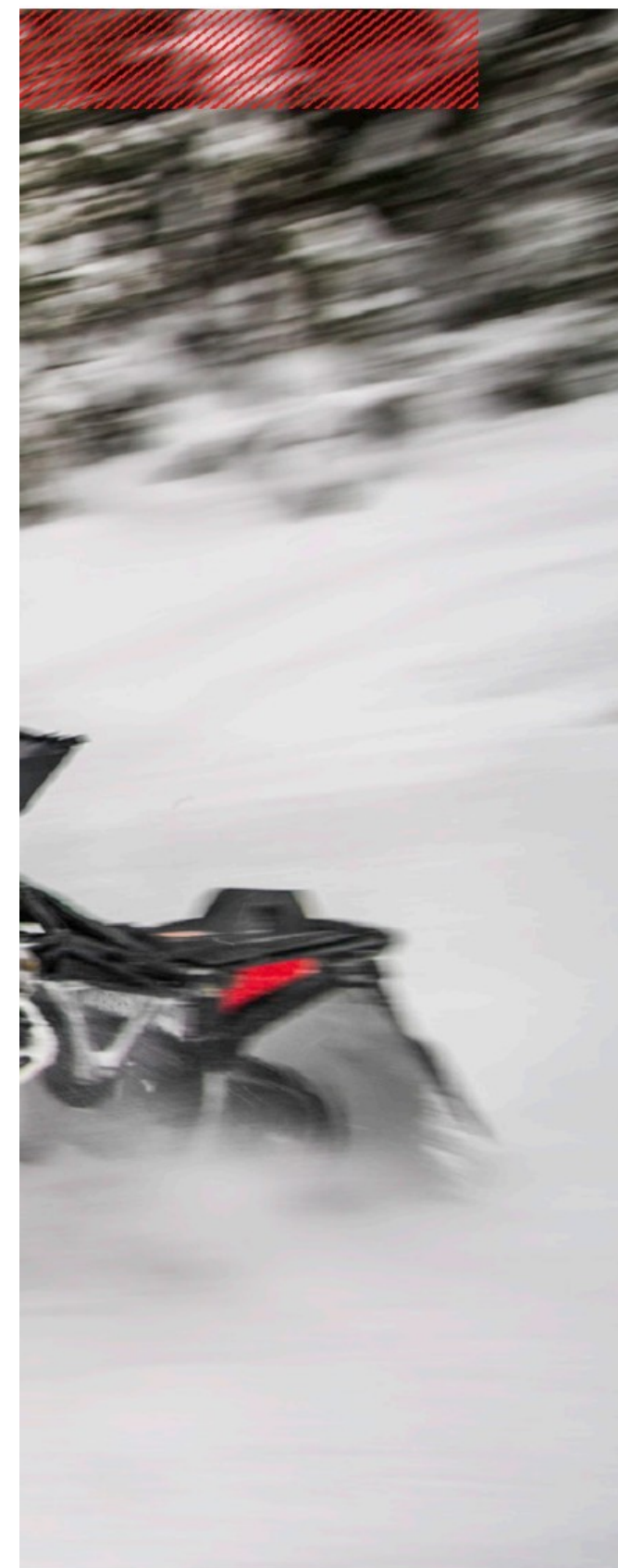

**P.30** WINDSHIELDS



**P.32** PROTECTION



## OWN THE TRAIL

You demand a lot from your RUSH®. Make sure you dial it in perfectly, and with your personal style, using the proper parts and accessories. When the group wants to ride hard, make sure you are locked in – and the one leading the pack.



**P.18** STORAGE



**P.28** SEATING



**P.32** PROTECTION





P.30 WINDSHIELDS

## PURE CAPABILITY

Find unrivaled confidence while in the backcountry, hitting the trail, or when working. Your Polaris® TITAN™ is engineered to perform a multitude of roles. Integrate the proper accessories and tailor it to your needs.



 POLARIS®

**TITAN**™



**P.18** STORAGE



**P.28** SEATING



**P.30** WINDSHIELDS



## INDY<sup>®</sup> PERFORMANCE REBORN

The most iconic name in snowmobiling has been reborn. Add smart storage, seating, protection and personal style across the expanded INDY<sup>®</sup> lineup, including the INDY<sup>®</sup> XC 129 with AXYS<sup>®</sup> Chassis.



**P.32** PROTECTION





®

# STORAGE & RACKS

STORAGE SHOPPING  
BASICS: FRONT TO BACK

## WINDSHIELD / DASH / HANDLEBAR / GOGGLE STORAGE

Perfect for items you need quick access to on the trail.

## UNDERSEAT STORAGE

Storage for a map, or for larger items like a first-aid kit and extra goggles.

## TUNNEL STORAGE

Perfect for holding enough items for a destination trip.

## CARGO RACK STORAGE

Strong and durable with versatile bag and accessory options.



## WINDSHIELD / DASH STORAGE

### WINDSHIELD BAG **AXYS**

- Bag installs inside base of windshield using stock push-dart fasteners
- Compression-molded semi-rigid material
- Uses engine heat to warm/dry goggles and gloves

Low Pro | 2880481  
ALL AXYS® AND POLARIS® TITAN™. ONLY FITS WITH LOW WINDSHIELD

Large | 2880374  
ALL AXYS® AND POLARIS® TITAN™. DOES NOT FIT WITH LOW WINDSHIELD

### WINDSHIELD REPLACEMENT BAG **AXYS**

- Combination windscreen and storage bag adds function and style
- Perfect for deep snow applications where over-the-hood sight lines are required
- Delivers quick access to personal items
- Semi-rigid design retains its shape even when empty or when the sled needs to be rolled to maneuver out of a stuck position

2882917  
ALL AXYS® AND POLARIS® TITAN™. REPLACES WINDSHIELD



5.4  
CUBIC LITRES



5.7  
CUBIC LITRES



5.6  
CUBIC LITRES



9.8  
CUBIC LITRES

### MOUNTAIN DASH BAG **AXYS**

- Semi-rigid, compression-molded bag installs on dashboard
- Convenient, protected storage for two bottles of water, goggles, and gloves
- Installs easily, holds its shape empty or full

2880375  
PRO-RMK® MY16-19, SKS 155 MY16-19, RMK® ASSAULT® MY16-19



### ULTIMATE DEFROST BAG **PRO-RIDE**

- Provides warm, dry place for goggles, gloves, and more
- Rigid construction holds its shape
- Durable 1,680-denier black ballistic nylon with water-resistant coating

2879090  
MY10-19 PRO-RIDE®, INCLUDES INDY® AND VOYAGEUR®, P.I.D.D. NOT INCLUDED

## HANDLEBAR / GOGGLE STORAGE



### CELL PHONE CHARGING BAG **NEW**

AXYS

- Charge your cell phone while the engine is running
- Includes wire harness, which connects to the sled's electrical system
- Use your device's charging cable to attach via USB connection inside bag

2883687

FITS ALL AXYS® WITH 12 CM, 15 CM, OR 18 CM RISE PROTAPER® BAR

2883786

FITS ALL AXYS® FLAT BAR APPLICATIONS



2.7  
CUBIC LITRES

### GOGGLE HANDLEBAR BAG

AXYS

- Conveniently access spare goggles from the driver's seat
- Attaches directly to handlebars with secure Velcro® straps

2882823

ALL AXYS®

### HANDLEBAR MAP BAG

AXYS PRO-RIDE

- Clear poly window displays trail map for easier navigation
- Attaches easily with all-weather Velcro® strips

2882824

ALL SNOWMOBILES

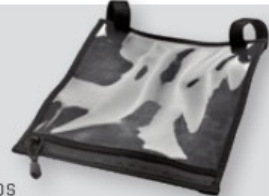

5.8  
CUBIC LITRES

### HEATED UNDERHOOD STORAGE

AXYS

- Underhood storage is ideal for storing goggles and keeping them defrosted
- Perfect for cold rides or deep powder days when swapping goggles is necessary
- Attaches securely using a bracket with fasteners and Velcro® straps

2882117

ALL AXYS®, DOES NOT FIT POLARIS® TITAN™ OR WITH 850 ENGINE



3.1  
CUBIC LITRES

### HANDLEBAR BAG

AXYS PRO-RIDE

- Durable, compression-molded semi-rigid material
- Two zippered compartments to hold small items

2880443

ALL AXYS® RUSH®, AXYS® SWITCHBACK®, ALL INDY® VOYAGEUR®, MY12-14 SWITCHBACK®, MY17-19 AXYS® 144, MY18-19 SKS 146, MY18-19 POLARIS® TITAN™. DOES NOT WORK WITH ROX® RISER (2881410)



### UNDERHOOD GOGGLE BAG

PRO-RIDE

- Heavy-duty nylon bag mounts under hood above exhaust
- Gloves, goggles, etc. are warmed by engine heat

2878735

ALL PRO-RIDE®



3.4  
CUBIC LITRES



5.2  
CUBIC LITRES

### PROTAPER® HANDLEBAR BAG

AXYS PRO-RIDE

- Durable black polyester fabric and semi-rigid material that holds its shape, empty or full

2880971

FITS ALL STRAIGHT BARS AND PROTAPER® BARS. DOES NOT FIT INDY® 550 AND VOYAGEUR® HANDLEBARS. DOES NOT WORK WITH ROX® RISER (2881410)

## UNDERSEAT STORAGE



5.1  
CUBIC LITRES

### REAR SEAT BAG

AXYS

- Front of bag attaches behind seat using Tuflok® fasteners (included)
- Compression-molded semi-rigid material

2881463

AXYS® RUSH®, AXYS® SWITCHBACK®, DOES NOT WORK WITH THE FOLLOWING RACKS (2880205, 2880205-458, 2880363-458, 2880362-458)



11.8  
CUBIC LITRES

### WATERPROOF UNDERSEAT LINER BAG

AXYS

- Fits inside stock underseat bag
- Perfect when riding in heavy, wet snow or backcountry powder

2882857

ALL MY17-19 SBA, MY18-19 SKS 146, MY17-19 VOYAGEUR® 600 144, ALL MY19 INDY® 129



7.7  
CUBIC LITRES

★ TOP SELLER

### BURANDT ADVENTURE UNDERSEAT BAG

AXYS

- Dual side-access zippers provide access to cargo when bag is installed
- Semi-rigid shell holds its shape, full or empty
- Engineered to withstand extreme riding conditions

2881056

ALL MY16-19 AXYS® PRO-RMK®, AXYS® SKS, AXYS® RMK® ASSAULT®

## TUNNEL STORAGE



WEATHER-RESISTANT LID

ADJUSTABLE VELCRO® DIVIDERS

**31.9**  
CUBIC LITRES



PREMIUM BACKCOUNTRY MOUNTAIN JACKET

FITS OVER THE TOP OF THE PREMIUM BACKCOUNTRY TUNNEL BAG

LOCK & RIDE

### PREMIUM BACKCOUNTRY TUNNEL BAG AXYS® PRO-RIDE®

- Reinforced high-density EVA compression molding provides high impact resistance and extreme tunnel protection
- Main storage allows for a customized configuration
- Bottom is designed with air flow channel to reduce heat between the tunnel and bag

2881979

ALL PRO-RMK®, SKS, RMK®, SKS 146, SWITCHBACK® ASSAULT®, INDY® 144, VOYAGEUR®

### PREMIUM BACKCOUNTRY MOUNTAIN JACKET

2882130

ALL PRO-RMK®, SKS, RMK® ASSAULT®, RMK®, SKS 146, SWITCHBACK® ASSAULT®, INDY® 144, VOYAGEUR®, REQUIRES PREMIUM LOCK & RIDE® BACKCOUNTRY TUNNEL BAG (2881979)



SMALL

5 CM BUCKLES

OVER-CENTER LOCK & RIDE®

**9.2**  
CUBIC LITRES



LARGE

WEATHER-RESISTANT LID

**14.7**  
CUBIC LITRES

LOCK & RIDE

### BURANDT ADVENTURE TUNNEL BAG AXYS® PRO-RIDE®

- 5 cm buckles provide easy access to gear with your gloves on
- Customizable configuration with Velcro® adjustable dividers

- Tray liner is water-resistant to keep your gear dry

Small | 2880969

Large | 2880970

ALL PRO-RMK®, SKS, RMK® ASSAULT®, SWITCHBACK® SP, SKS 146, SWITCHBACK® ASSAULT®, RMK®, INDY® 144, VOYAGEUR®, LARGE BAG WILL NOT WORK WITH 144" TUNNELS OR FUEL CAN RACKS ON 155" TUNNELS.

### TRAVERSE TUNNEL BAG **NEW**

- 5 cm buckles make it easy to access your gear with gloves on
- Water-resistant construction
- Attaches in seconds with Lock & Ride® technology

2883570

FITS ALL FULL TUNNEL 129" AND LONGER SLEDS WITH T-SLOT ATTACHMENT

PRO-RIDE®

# INDY®



### INDY EVO™ TUNNEL STORAGE BAG

- Provides underseat storage for quick access
- Compression molded design provides rigidity
- Attaches easily with all-weather Velcro® strips

2883671

MY19 INDY EVO™



**3.9**  
CUBIC LITRES

### HANDLEBAR BAG

- Provides quick, convenient access to essential items
- Semi-rigid design retains its shape even when empty
- Attaches easily with all-weather Velcro® strips

2882829

MY13-19 INDY®, MY13-19 INDY® SP, MY14-19 INDY® ES



SMALL

**9.2**  
CUBIC LITRES

**12.3**  
CUBIC LITRES



LARGE

**LOCK & RIDE** **ULTIMATE SHOVEL BAG** **AXYS** **PRO-RIDE**

- Semi-rigid compression-molded material
- Mesh pocket inside exterior shell
- Customize interior with adjustable Velcro® dividers
- Holds secondary shovel head, handle, and essential extra gear (sold separately)
- Shovel sold separately

Small | **2881057**

Large | **2882822**

ALL PRO-RMK®, SKS, RMK® ASSAULT®, SWITCHBACK® SP, SKS 146, SWITCHBACK® ASSAULT®, RMK®, INDY® 144, VOYAGEUR®, LARGE BAG WILL NOT WORK WITH 144" TUNNELS OR FUEL CAN RACKS ON 155" TUNNELS

**LOCK & RIDE** **HARDWARE REPLACEMENT**

- Sold individually
- 2881260**  
ALL AXYS® & PRO-RIDE®



**SEMI-RIGID TUNNEL BAGS**

**AXYS** **PRO-RIDE**

- Heavy-duty nylon; water-resistant
- Mounts quickly and easily on tunnel

**2880607**  
MY13-19 PRO-RIDE® CHASSIS INDY®



**SNOBUNJE® RATTLER**

- Deep snow extraction device
- Hook attaches to ski; use handle to pull

**2874420**



**LOCK & RIDE** **ADJUSTABLE FUEL CAN RACK**

**AXYS** **PRO-RIDE**

- Installs quickly and easily in tunnel's T-slots
- Holds most 9.5 L fuel cans
- Fuel can sold separately; not through Polaris®

Aluminum | **2879790**

Matte Black | **2879790-458**

ALL PRO-RMK®, SKS, RMK® ASSAULT®, RMK®, SWITCHBACK® ASSAULT®, INDY® 144, VOYAGEUR® DOES NOT FIT WITH LARGE BURANDT ADVENTURE BAG (2880970) ON 155" TUNNELS.



**SNOW SHOVEL**

- Includes integrated saw in the handle

**2875094**



**240CM AVALANCHE PROBE**

**2874916**



**SNOWBOARD & SKI RACK**

**AXYS** **PRO-RIDE**

- Multi-use for ski to snowboard applications via brackets
- Minimalist design usage allows room for tunnel bag, backpack, or gas can rack
- Versatile rack allows ability to install on either side of the tunnel

**2881251**  
ALL PRO-RMK®, SKS, RMK® ASSAULT®, VOYAGEUR® 155



**FUEL CAN RACK STRAPS**

**7081248**  
AXYS® AND PRO-RIDE®

EXCLUSIVE INDY® STORAGE



**15.2**  
CUBIC LITRES

**LOCK & RIDE** **TUNNEL BAG**

- Tunnel-top storage provides storage for larger items including clothing and gloves
- Semi-rigid design retains its shape even when empty
- Large zippered opening delivers easy storage access

**2882788**  
MY13-MY19 INDY®, MY13-MY19 INDY® SP, MY14-MY19 INDY® ES



**8.2**  
CUBIC LITRES

**UNDERSEAT BAG**

- Take advantage of underseat space with this easy-access storage bag
- Semi-rigid design retains its shape even when empty
- Attaches easily with all-weather Velcro® strips

**2882786**  
MY13-MY19 INDY®, MY13-MY19 INDY® SP, MY14-MY19 INDY® ES

# SWITCHBACK® CARGO RACK

AXYS®

- Strong, durable aluminum construction
- Easy bolt-on installation; all mounting hardware included

Aluminum | 2880205

Matte Black | 2880205-458

SWITCHBACK® ADVENTURE '19, MY15-19 SWITCHBACK® 137

# 13.6

KG STORAGE



## SWITCHBACK® CARGO RACK BAG OPTIONS



### CARGO RACK BAG

Weather-resistant design helps seal out snow and moisture to keep cargo dry. Durable, semi-rigid, compression-molded design resists impacts.

2881967

MY15-19 SWITCHBACK® 137, (REQUIRES RACK 2880205 OR 2880205-458)



22.3  
CUBIC LITRES



### UNDERSEAT ESSENTIALS BAG

Holds goggles, gloves, water bottle, and more. Durable, semi-rigid, compression-molded design resists impacts.

2880373

MY15-19 AXYS® RUSH® 120 & SWITCHBACK® 137

5.4  
CUBIC LITRES



### X2 BACKREST CARGO RACK BAG

Weather-resistant design helps seal out snow and moisture to keep cargo dry. Durable, semi-rigid, compression-molded design resists impacts.

2881966

MY15-19 SWITCHBACK® 137, (REQUIRES RACK 2880205 OR 2880205-458)



10.5  
CUBIC LITRES

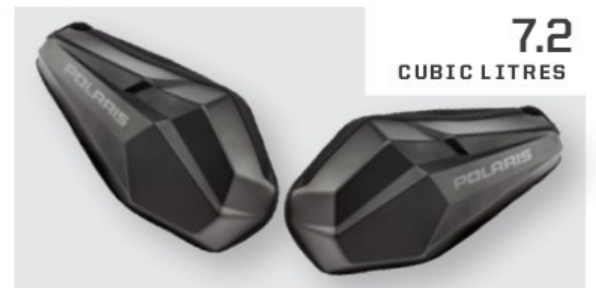

### SOFT SADDLEBAGS

Expand your storage options with soft-sided saddlebags. Semi-rigid design retains its shape even when empty. Large zippered opening delivers easy storage access. Attaches quickly and securely with all-weather Velcro® strips.

2882094

MY15-19 SWITCHBACK®, REQUIRES SWITCHBACK® CARGO RACK (2880205 OR 2880205-458)

7.2  
CUBIC LITRES



### UNDERSEAT JOURNEY BAG

Front of bag attaches behind seat using Tuflok® fasteners (included). Center cargo compartment and two side compartments. Durable, semi-rigid, compression-molded design resists impacts.

2880372

MY15-19 AXYS® RUSH® 120 & SWITCHBACK® 137



10.8  
CUBIC LITRES



### LOCK & RIDE CARGO RACK SADDLEBAGS

Impact-modified nylon shell and water-resistant removable liner for underseat cargo bag.

2878720

MY15-19 AXYS® SWITCHBACK® 137 (REQUIRES RACK 2880205 OR 2880205-458)



6.8

KG STORAGE

### REAR SPORT RACK **AXYS**

- Easy bolt-on installation; all mounting hardware included

Matte Black | 2880362-458  
MY15-19 RUSH®

Matte Black | 2880363-458  
MY15-19 SWITCHBACK® 137



### CARGO RACK 144" **AXYS** **PRO-RIDE**

- Design offers three-level storage: Cross bars low, medium, and high
- Angled design accommodates tie-down straps to secure cargo

Matte Black | 2881940-458

MY17-19 AXYS® 144, MY18-19 SKS, ALL 550 AND 600 VOYAGEUR® MODELS

## BAG OPTION



### SPORT RACK BAG

Bag attaches to rack and behind seat using Tuflok® fasteners. Durable, semi-rigid, compression-molded design resists impacts.

2881464  
AXYS® RUSH® 120 & SWITCHBACK® 137

15.6  
CUBIC LITRES

## BAG OPTION



### CARGO BAG 144"

Semi-compressed with nylon side bag installs securely in cargo rack. Versatile bag can be converted to a single large cargo compartment.

2881968  
MY17-19 AXYS® 144, MY18-19 SKS 146, ALL 550 AND 600 VOYAGEUR® MODELS (REQUIRES CARGO RACK 2881940 OR 2881940-458)

TUNNEL CAPACITY VARIES. PLEASE SEE DECAL ON TUNNEL FOR YOUR VEHICLE'S SPECIFICATIONS



### FT2 UNDER RACK BAG **NEW**

- Easy access with weather-resistant zipper
- Compression-molded design provides rigidity
- Attaches directly to rack with all-weather Velcro®

2883714

MY19 INDY® XC 129, MY19 INDY® SP 129, MY17-19 SWITCHBACK® ASSAULT®, MY18-19 144 VOYAGEUR® (REQUIRES FT2 REAR SEAT RACK (2883646))

### FT2 REAR SEAT RACK **NEW**

- Attaches in seconds with Lock & Ride® technology
- Made of powdercoated high-quality steel

2883646

ALL FULL TUNNEL AXYS® 129 AND 144 SLEDS (REQUIRES 2883838 TO INSTALL THE FT2 RACK ON THE MY17-19 VOYAGEUR® 600)

**A** LOCK & RIDE

## VERSA REAR CARGO RACK

- Rugged aluminum powder-coated rear rack delivers versatile storage solutions
  - Bolts securely to tunnel and features multiple cargo tie-down points
- » 2882792

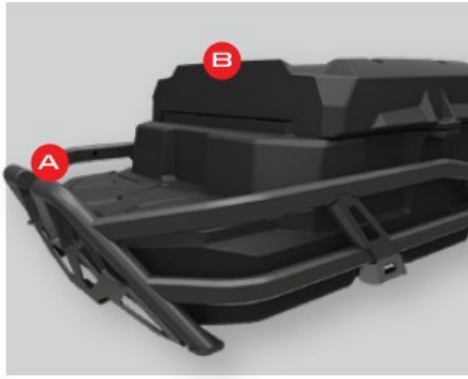

## ICE AUGER RACK

- Premium steel rack securely holds your ice auger for easy transport
- » 2882799



## GUN & ROD MOUNT

- Versatile and rugged mount affixes to side of tunnel
  - Conveniently accepts accessory gun boots or ice rod lockers
  - Retains storage capabilities of rear rack
- » Kolpin® Stronghold Mount 2882806  
 » Gun Scabbard by Kolpin® 2882426  
 » Ice Rod Locker 2882428



### STORAGE OPTIONS

**B** LOCK & RIDE

## VERSA REAR CARGO BOX

- Heavy-duty roto molded box mounts to accessory rear luggage rack with Lock & Ride™ technology
  - Easy-open hinge lid can utilize an optional padlock for security
  - A total of 70.1 liters of storage space
- » 2882793

**C** LOCK & RIDE

## UNDER-PASSENGER SEAT BAG

- Take advantage of underseat space with this easy access storage bag
  - Semi-rigid design retains its shape even when empty
  - Attaches easily with Velcro® strips
- » 2882807
- DOES NOT WORK WITH VERSA REAR CARGO BOX 2882793 P282/P283. RECOMMENDED WITH VERSA TOURING PASSENGER SEAT 2882791



## INTEGRATED 680.4KG WINCH

- Versatile and rugged winch can clear downed trees or retrieve a stuck snowmobile
  - Features a powerful 680.4 kg towing capacity
  - Mounts to rear of sled with included receiver hitch
  - Includes wireless winch remote
- » 2882798

LOCK & RIDE

# XL TITAN SCANDI CARGOBOX



- Cargo box 100 liter with straps. Cargo can also be stored on the lid with straps.
- » P282
- NOTE: (CARGO BOXES CAN ONLY BE USED WITH 1-UP SEAT, L6R SOLD SEPARATELY.)



- Cargo box with backrest, 100 liter with straps. Cargo can also be stored on the lid with straps.
- » P283
- NOTE: (CARGO BOXES CAN ONLY BE USED WITH 1-UP SEAT, L6R SOLD SEPARATELY.)



- Cargo box 110 liter with straps. Titan Adventure. Cargo can also be stored on the lid with straps.
- » P284

### SEAT OPTIONS (SEE P. 28)

LOCK & RIDE

## VERSA TOURING PASSENGER SEAT

- » Standard | 2882791      » Heated | 2882801



# VOYAGEUR® 155" EXTREME REAR RACK

- Strong, durable tubular construction
- Easy bolt-on installation
- » 2880275  
550 INDY® VOYAGEUR® 155



BAG OPTIONS



### EXTREME REAR BAG

Durable polyester shell engineered to withstand extreme riding conditions. Easy installation with strong straps with Velcro®. Bag has multiple cargo compartments with zippered closures.

» 2881250



### EXTREME REAR RACK LINER

Strong, durable plastic construction.

» 2880478



### CARGO BOX VOYAGEUR 155.

- INDY 550 Voyageur 155 15-16 P261 | 155", 15-16, 2017-2018 With cargo rack 288275 installed

# VOYAGEUR® 2-UP TOURING CARGO RACK

- Installs in tunnel T-slots
  - Carriage bolts for secure installation
  - » 2878156
- VOYAGEUR®, 550 INDY® 144, MY10-16 SWITCHBACK® AS-SAULT®, MY10-16 RMK®, MY10-15 PRO-RMK®  
NO 2-UP RIDING ON 550 INDY® 144, MY10-16 SWITCHBACK®
- ASSAULT® MY10-16 RMK®, MY10-15 PRO-RMK® DUE TO 6.8 KG WEIGHT CAPACITY

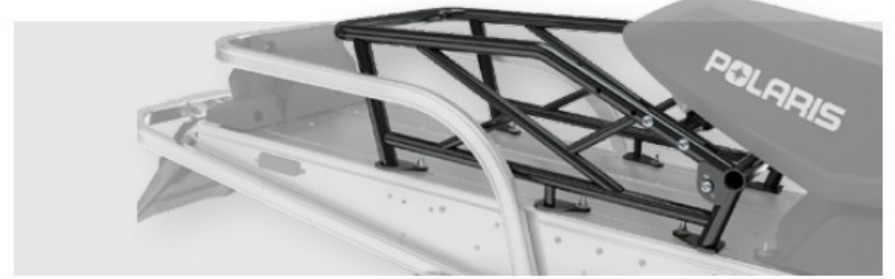

BAG OPTIONS



### CARGO RACK BAG

Installs in tunnel T-slots. Carriage bolts for secure installation. All mounting hardware included.

» 2878158

40.97 LITERS

SEAT OPTIONS (SEE P. 28)

2-UP TOURING KIT  
» 2878157

### CARGO BOX VOYAGEUR / LXT

- Cargo box 550 LXT14-19, IQ 550 Shift 136" 11-13. Voyageur 144, Voyageur 600 15-16 | Fits in Voyageur cargo rack 2878156 | (E) 550 INDY Voyageur 155" 15-16 | P294 |



# ADVENTURE CARGO RACK

- Strong, durable aluminum
- Installs securely; six fasteners in tunnel T-slots
- Stock rack can be added as rack extension
- All mounting hardware included
- » Brushed Aluminum 2879846  
VOYAGEUR®, INDY® 144, MY11-16 SWITCHBACK® ASSAULT®



BAG OPTIONS



LOCK & RIDE

### REAR RACK BAG

Compression-molded plastic with zippered closure and zippered expansion panel.

» 2878731

14.42 LITERS

SEAT OPTIONS (SEE P. 28)

LOCK & RIDE® CONVERTIBLE PASSENGER SEAT  
» 2879839



# RECEIVER HITCH DRAW BARS



## J-HITCH

B0221, J-Hitch can be mounted on all snowmobile units from MY 1998-2019. Mounts for each model of snowmobile are listed below and are available in black color. More mounts can be purchased just contact your local dealer for hitch to your model of snowmobile.

- » B0130 J-Hitch Widetrack GT/ LX/ IQ
- » B0221 J-Hitch 1989-2019
- » MN1007 K-Mount AXYS RUSH/ AXYS SWB 15-19
- » MN1002 K-Mount RUSH 11-14
- » MN1002 K-Mount SWB 136" PRO-RIDE 12-14
- » B0255 K-Mount 600/800 INDY XC 129" 2019-
- » B0251 K-Mount AXYS RMK 8 SKS 155" 2016-2019
- » B0254 K-Mount AXYS SKS 146" 600/800 Switchback Assault 144" 800 Switchback SP 144" 2019
- » B0252 K-Mount AXYS SWB Assault/ SP 144", SKS 146" - 2018
- » B0245 K-Mount RMK 144" 2012-2019
- » B0246 K-Mount RMK 155" 12-15
- » B0247 K-Mount RMK 163" 2011-2015
- » B0248 K-Mount INDY Voyageur 550 14, 550 Adventure X2 14-16
- » B0245 K-Mount 600 INDY VOYAGER 2014 - 2016
- » B0236 K-Mount IQ 121" 08-2012, IQ SWB 136" 08-10
- » B0245 K-Mount Switchback 144" 11-15
- » B0244 K-Mount INDY 121", INDY EVO 19-
- » B0232 K-Mount 600 IQ LXT Touring 11-14
- » B0236 K-Mount 550 IQ LXT Touring 11-13
- » B0232 K-Mount Touring 07-12
- » B0234 K-Mount RMK 144" 07-11
- » B0235 K-Mount RMK 155" 07-10
- » B0237 K-Mount 600RR 08-09
- » B0249 K-Mount 550 INDY VOYAGER 2015-2016
- » B0249 K-Mount 550 INDY Adventure 2015-2016



### STAND-ALONE HITCHES



**J-HOOK**  
 » 2882918  
 • J-Hitch 4 bolt USA version



**STANDARD**  
 » 2882812  
 • Hitch flapper 4-Bolt USA version.

### HITCHES

- 32MM RECEIVER**  
 » 2882795
- BALL HITCH**  
 • Allows customer to use any size ball with 19mm shank  
 • Requires 32mm receiver (2882795)  
 • Ball not included  
 » 1002



### HITCH ADAPTER

- Bolts onto either the J-hook or Standard hitch to allow them to be used with 32mm receiver installed
- Allows user to change between J-hook, Standard, and Ball Hitch without the use of tools
- » 2882814

### J-HITCH SCANDI

- » B0131 J-Hitch 4-Bolts safety hitch.

# SEATS

LOCK & RIDE

**NEW**

## LOCK & RIDE® FT2 PASSENGER SEAT

- Installs/removes easily in seconds with Lock & Ride® technology
- Enhances driver and passenger comfort
- Includes backrest, seat, and handholds
- Heated grips & plug in for passenger's heated visor

- Requires FT2 Rear Seat Rack (2883646) P. 63

**2883637**

INDY® XC 129 '19, INDY® SP 129 '19, MY17-19 SWITCHBACK® ASSAULT®, ALL MY18-19 144 VOYAGEUR®, ALL AXYS® 129 144 & 146

### HANDWARMER KIT

- Required to power the passenger handwarmers on MY17-18 AXYS® 144 sleds

**2883851**

MY17-18 144 AXYS®

### VOYAGEUR® 144 BRAKE LIGHT SUPPORT KIT

**2883838**

ALL AXYS® VOYAGEUR® 144

## LOCK & RIDE X2 BACKREST WITH HANDHOLDS AXYS®

- Enhance passenger comfort and confidence
- Heated handholds
- Provides passenger with comfortable backrest
- X2 Seat and Cargo Rack each sold separately

**2881164**

AXYS® SWITCHBACK®, AXYS® SWITCHBACK ADVENTURE®, REQUIRES AXYS® X2 PASSENGER SEAT (2880378). REQUIRES AXYS® CARGO RACK (2880205 OR 2880205-458). DOES NOT WORK WITH THE AXYS® RACK BAG (2880376)

SECURE COMFORT BACKREST

HEATED HANDHOLDS

## X2 PASSENGER SEAT

- Quick and easy installation; includes mounting hardware and heavier rear spring

**2880378**

AXYS® SWITCHBACK®, AXYS® SWITCHBACK ADVENTURE®, \*REQUIRES AXYS® CARGO RACK (2880205 OR 2880205-458)

LOCK & RIDE

## X2 SEAT BACKREST

- Enhances passenger comfort and security

**2880377**

AXYS® SWITCHBACK®, AXYS® SWITCHBACK ADVENTURE®, \*REQUIRES AXYS® CARGO RACK (2880205 OR 2880205-458). DOES NOT WORK WITH THE AXYS® RACK BAG (2880376). USE SWITCHBACK®, WATER-RESISTANT REAR RACK BAG (2878731)



**NEW**

## PASSENGER GAUNTLET

**2883573**

VERSA TOURING PASSENGER SEAT & FT2 PASSENGER SEAT

LOCK & RIDE

## VERSA TOURING PASSENGER SEAT

- Attaches/removes in seconds with Lock & Ride® technology
- Heated version available
- Includes heated hand grips and connection for heated visor on full-face helmets
- Requires Versa Rear Cargo Rack (2882792)

Standard | **2882791**

Heated | **2882801**

ALL TITAN™



**HEATED SEAT** AXYS™

- Keep warm during the most demanding winter rides
- Features easy to use high/low/off switch for complete control
- Complete seat assembly with all mounting hardware and harness

Black | **2882819**  
 ALL MY15-19 RUSH®, MY15-19 SWITCHBACK®, MY18-19 SKS 146, 144 RMK® 144, VOYAGEUR® 600 MY17-19, 129 XC 129, SP 144 INDY® SP MY19

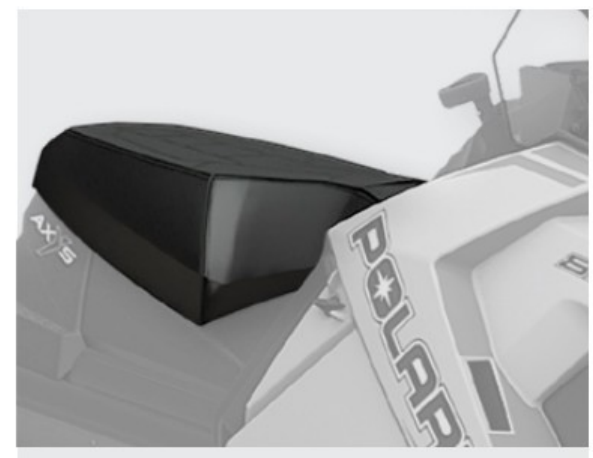

**POLARIS® TITAN™ HEATED SEAT**

- Keep warm during the most demanding winter rides
- Features easy to use high/low/off switch for complete control
- Complete seat assembly with all mounting hardware and harness

Black | **2882747**  
 ALL TITAN™

**LOCK & RIDE** PRO-RIDE™  
**CONVERTIBLE PASSENGER SEAT**



- Accommodates passenger and cargo up to 150 lbs./68 kg.

**2879839**  
 VOYAGEUR® '19, INDY® SP 144 '19, INDY® LXT '19, INDY® ADVENTURE '19, INDY® 144 '19, INDY® '18

**B CONVERTIBLE PASSENGER SEAT BACKREST**

- Enhances passenger comfort
- Attaches securely to seat

**2879841**  
 MY11-19 VOYAGEUR®, MY11-19 INDY® SP 144, MY11-19 INDY® LXT, MY11-19 INDY® ADVENTURE, MY11-19 INDY® 144

**C HEATED GRIPS**

- Enhances passenger comfort
- Powered by sled's electrical system

**2879840**  
 MY11-19 VOYAGEUR®, MY11-19 INDY® SP 144, MY11-19 INDY® LXT, MY11-19 INDY® ADVENTURE, MY11-19 INDY® 144

**D 2-UP TOURING KIT**

- Enhances driver and passenger comfort
- Includes backrest, seat, and handholds

**2878157**  
 VOYAGEUR®, INDY® 144. REQUIRES 2-UP TOURING CARGO RACK (2878156)

**E PASSENGER HANDWARMER KIT**

- Provides a passenger's hands with heat
- Heater control includes multiple heat settings, including OFF

**2878201**  
 VOYAGEUR®, INDY® 144. \*REQUIRES VOYAGEUR® 2-UP TOURING CARGO RACK (2878156) OR VOYAGEUR® 155. EXTREME REAR RACK (2880275); BOTH SOLD SEPARATELY



**COLORED SEAT SUPPORT** AXYS™

- Same construction as stock seat support for perfect fit
- Finish is color-matched to Polaris® graphics and resists chipping and wear

Red		2881438-293
Black		2881438-458
Lime Squeeze		2881438-630
Orange		2881438-647
Blue		2881438-689
Matte Gold Metallic	<b>NEW</b>	2881438-703
Sky Blue	<b>NEW</b>	2881438-737

ALL MY16-18 AXYS® PRO-RMK®, RMK® ASSAULT® 6 SKS



**KIT-LIGHTWEIGHT RMK® SEAT**

**2879089**  
 MY11-19 PRO-RMK®, RMK® ASSAULT® 6 SKS



**PASSENGER FOOTRESTS** AXYS™

- Add passenger comfort and security with passenger footrests
- Extruded aluminum design attaches directly to running board

Matte Black | **2882797**  
 ALL TITAN™

Raw | **2882817**  
 FITS AXYS® SWITCHBACK® 137

**NEW** Raw | 129/144 | **2883571**  
 MY19 INDY® XC 129, MY19 INDY® SP 129, MY17-19 SWITCHBACK® ASSAULT®, ALL AXYS® 129 144 6 146

# WINDSHIELDS

Blend protection and style  
and find your ideal sightline



18 CM  
TALL

## LOW WINDSHIELD

AXYS®

Black / Gray	2880385
White / Black	2880386
Red / White	2880387
Blue / White	2881244
Orange / Black	2881245
White	2882062
Lime Squeeze	2882826

ALL AXYS® AND POLARIS® TITAN™  
COMBINE WITH AXYS® LOW  
WINDSHIELD BAG (2880481, P. 58)



33 CM  
TALL

## DEEP SNOW MID WINDSHIELD

AXYS®

Blue	2881053
White	2881054
Matte Black	2881055
Red	2881436
Gloss Black	2882058

ALL AXYS® AND POLARIS® TITAN™  
COMBINE WITH AXYS®  
WINDSHIELD BAG (2880374 ON PG. 58)



46 CM  
TALL

## FLATLAND MID WINDSHIELD

AXYS®

Clear	2880389
Gloss Black	2880390
White	2880391
Red	2880392

ALL AXYS® AND POLARIS® TITAN™



51 CM  
TALL

★ TOP SELLER

## TALL WINDSHIELD

AXYS®

Smoke	2880394
-------	---------

ALL AXYS® AND POLARIS® TITAN™

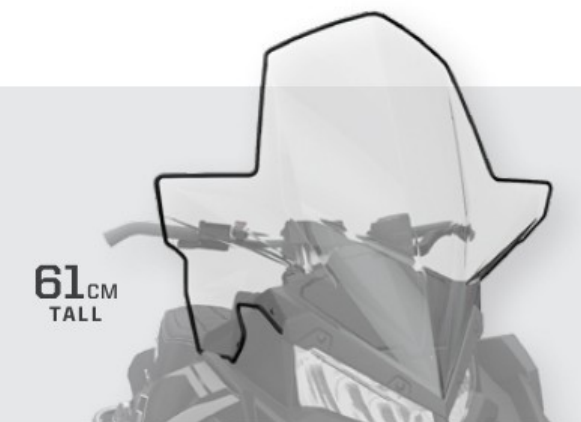

61 CM  
TALL

## EXTRA TALL WINDSHIELD

AXYS®

Clear	2883078
-------	---------

ALL AXYS® AND POLARIS® TITAN™



64 CM  
TALL

## FULL COVERAGE WINDSHIELD

Clear	2882796
-------	---------

ALL AXYS® AND POLARIS® TITAN™



18cm TALL

LOW WINDSHIELD

PRO-RIDE®

- Black 2878779
- White 2879097

ALL PRO-RIDE®



36cm TALL

MID WINDSHIELD

PRO-RIDE®

- Smoke 2877841
- Matte Black 2879828
- White Gloss 2879829

ALL PRO-RIDE®

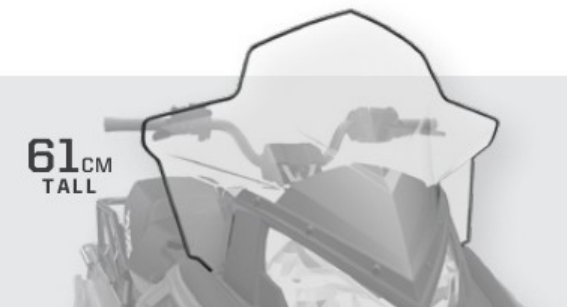

61cm TALL

WIDE WINDSHIELD PRO-RIDE®

- Clear 2878512

ALL PRO-RIDE®

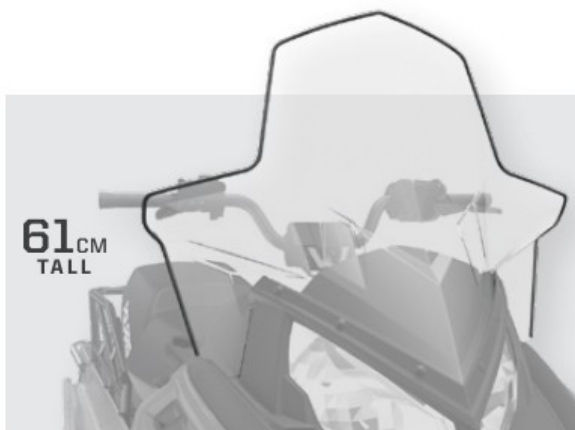

61cm TALL

EXTRA-WIDE TALL WINDSHIELD

PRO-RIDE®

- ✕ Clear 2879156

ALL PRO-RIDE®



WIND DEFLECTORS

PRO-RIDE®

- Rubber deflectors with adhesive backing
- Set of two
- Flared edge deflects wind, snow, and ice

2878723

ALL PRO-RIDE®



FULL COVERAGE

EXTRA TALL

TALL

MID

DEEP SNOW MID

LOW

FIND YOUR PERFECT SIGHTLINE

Blend protection and style with the windshield built just for the type of riding you do most.

TALL

The choice when you want maximum wind protection. Perfect for riders who ride in colder conditions often.

MID

The best of both worlds: a clean look for your sled that also offers wind protection for colder days.

LOW

For a sleek, clean look on your sled. Does not affect vision in any way. Great for riders who stand up most of the time.

WINDSHIELDS

# BUMPERS

## FRONT BUMPERS

• DELIVERS ENHANCED FRONT-END PROTECTION

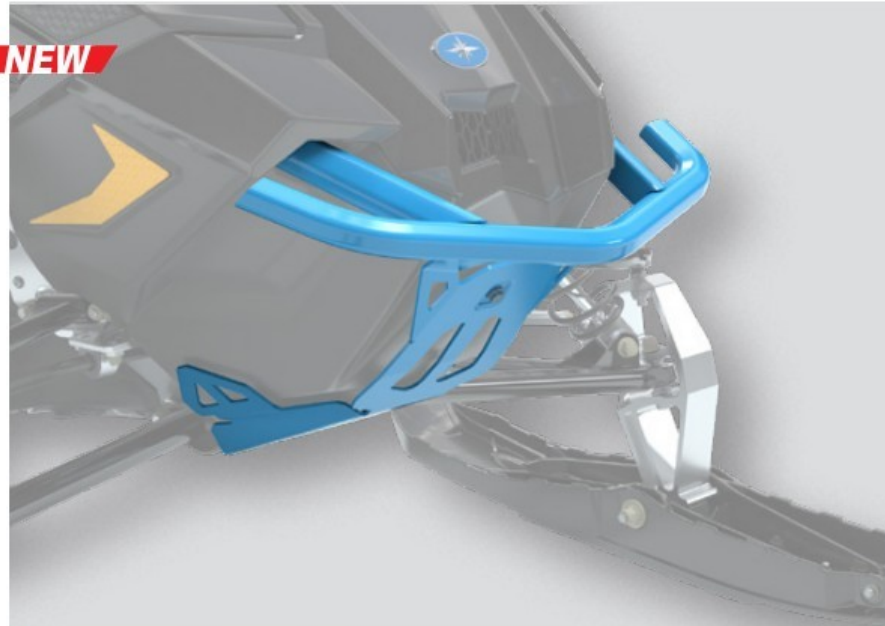

**NEW**

PROTECTION: MAXIMUM



PROTECTION: MAXIMUM ————— MEDIUM



### MONARCH **AXYS**

White	2883681-133
Red	2883681-293
Matte Black	2883681-458
Lime Squeeze	2883681-630

Orange	2883681-647
Blue	2883681-689
Matte Gold Metallic <b>NEW</b>	2883681-703
Sky Blue <b>NEW</b>	2883681-737

ALL AXYS

### ULTIMATE **PRO-RIDE**

Aluminum	2879727
White	2879727-133
Matte Black	2879727-458

ALL PRO-RIDE<sup>®</sup>. INCLUDES INDY<sup>®</sup> & VOYAGEUR<sup>®</sup>. WILL NOT FIT WITH ANY SKID PLATE

### EXTREME **PRO-RIDE**

Aluminum	2878688
White	2878688-133
Matte Black	2878688-458

ALL PRO-RIDE<sup>®</sup>. INCLUDES INDY<sup>®</sup> & VOYAGEUR<sup>®</sup>

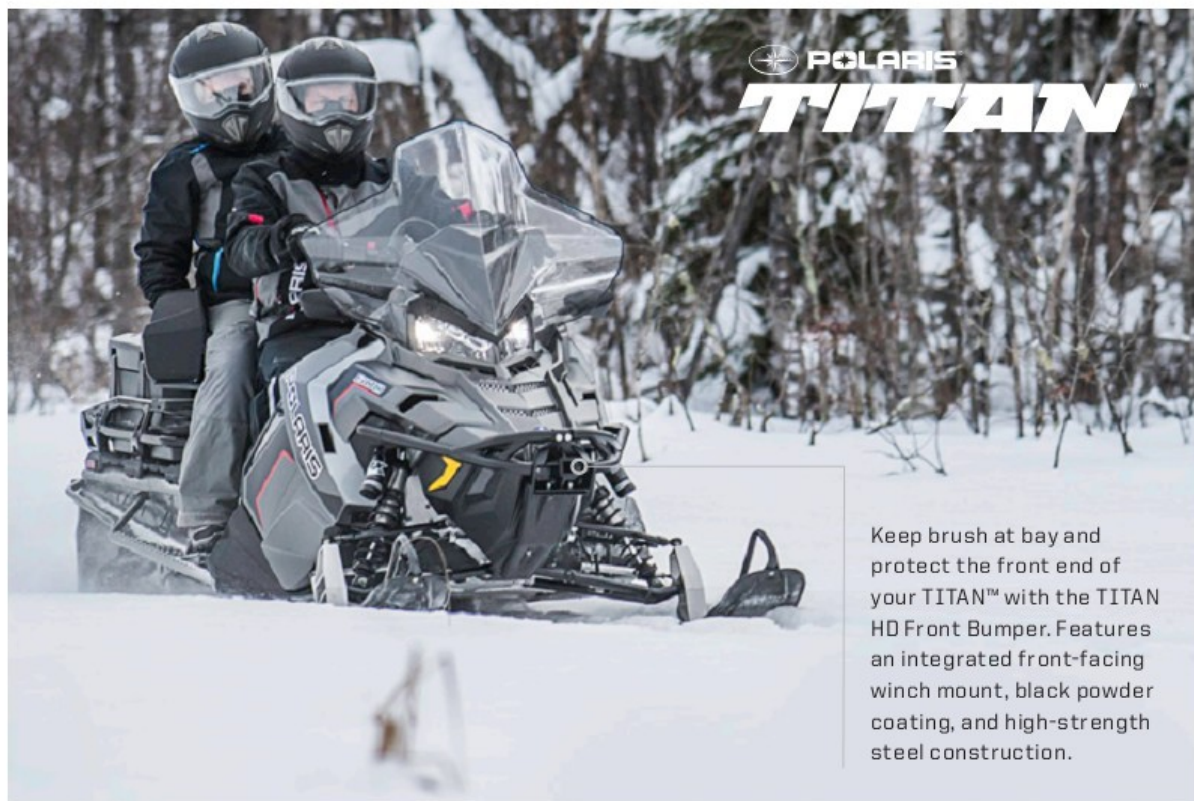

POLARIS  
**TITAN**

Keep brush at bay and protect the front end of your TITAN™ with the TITAN HD Front Bumper. Features an integrated front-facing winch mount, black powder coating, and high-strength steel construction.



**NEW**

Includes 3.175 cm hitch receiver

PROTECTION: MAXIMUM

### HD FRONT BUMPER

Black	2882794
-------	---------

ALL TITAN™



### TITAN™ REAR BUMPER HANDLES

• Convenient rear grab points for your Polaris® Titan™

2882803  
ALL TITAN™

### TITAN™ LIGHTBAR MOUNT

2882815  
ALL TITAN™  
FITS LIGHTBARS 2882313 OR 2882078 (NOT INCLUDED)





## REAR BUMPERS

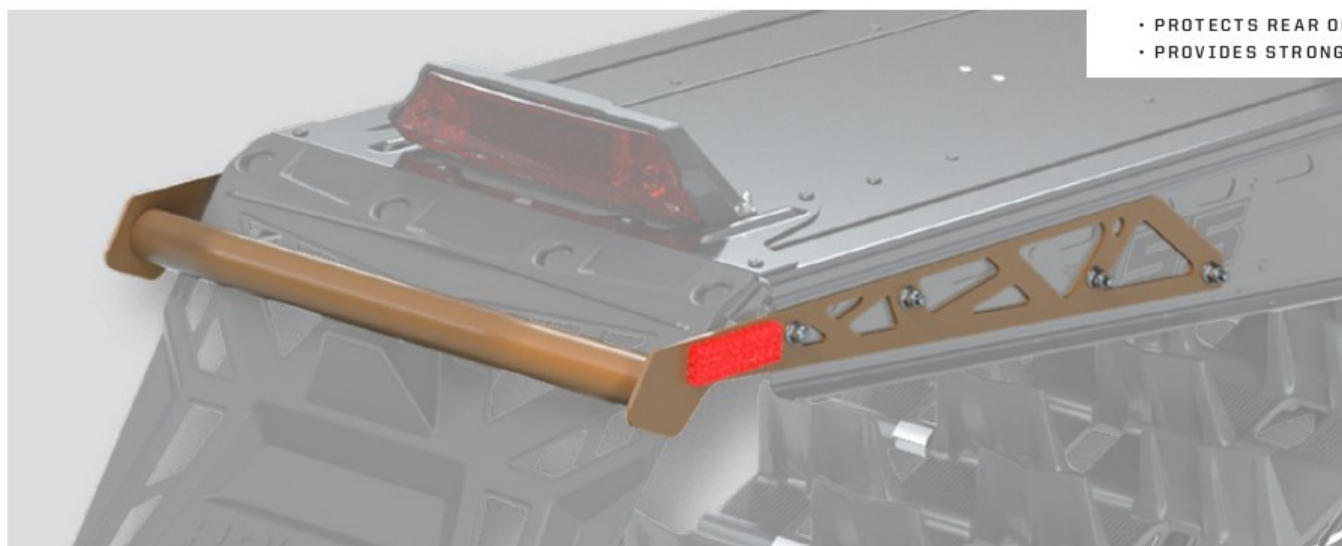

- PROTECTS REAR OF SNOWMOBILE
- PROVIDES STRONG GRAB BAR FOR SLED LIFTING

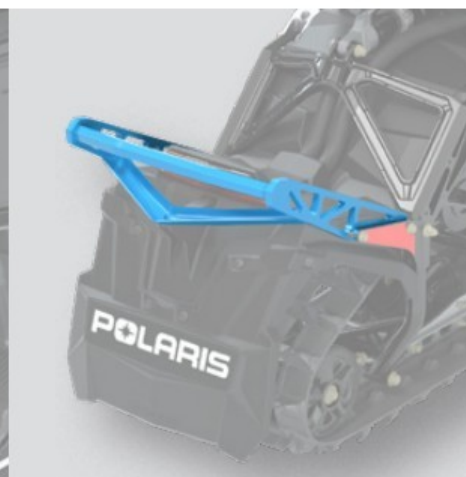

### EXTREME 366<sub>CM</sub> // 394<sub>CM</sub>/414<sub>CM</sub> // 442<sub>CM</sub> **AXYS**

COLORS	366 <sub>CM</sub>	394 <sub>CM</sub> /414 <sub>CM</sub>	442 <sub>CM</sub>
White	2881941-133	2880993-133	2881754-133
Red	2881941-293	2880993-293	2881754-293
Black	2881941-458	2880993-458	2881754-458
Lime Squeeze	2881941-630	2880993-630	2881754-630
Orange	2881941-647	2880993-647	2881754-647
Blue	2881941-689	2880993-689	2881754-689
Matte Gold Metallic <b>NEW</b>	2881941-703	2880993-703	2881754-703
Sky Blue <b>NEW</b>	2881941-737	2880993-737	2881754-737

144" FITMENT: MY17-19 SWITCHBACK® ASSAULT®, MY17-19 SWITCHBACK® SP, MY17-19 600 VOYAGEUR®, MY17-19 RMK® 144. 155"/163" FITMENTS: ALL MY16-19 AXYS® PRO-RMK®, RMK® ASSAULT®, AND SKS 155"/163" SLEDS. 174" FITMENT: MY17-19 PRO-RMK® 174

### ELITE PRO **AXYS**

White	2882926-133
Red	2882926-293
Black	2882926-458
Lime Squeeze	2882926-630
Orange	2882926-647
Blue	2882926-689
Matte Gold Metallic <b>NEW</b>	2882926-703
Sky Blue <b>NEW</b>	2882926-737

MY15-19 RUSH®, MY15-19 SWITCHBACK®, DOES NOT FIT SWITCHBACK® ASSAULT®

# RUNNING BOARDS



Give your foothold a customized look with factory-matched running board options



LIGHTWEIGHT  
EXTRUDED  
ALUMINUM

EXTREME 366cm/371cm



EXTREME 394cm/414cm



EXTREME 442cm

## EXTREME 366cm/371cm // 394cm/414cm // 442cm **AXYS**

- Design optimizes snow extrusion to prevent ice buildup for optimal rider control and performance
- Secure front and rear attachment with factory-bonded castings
- Removable and serviceable running board assemblies

COLORS	366cm/371cm	394cm/414cm	442cm
<input type="checkbox"/> Bright White	2881965-133	2881041-133	2881952-133
<input checked="" type="checkbox"/> Indy Red	2881965-293	2881041-293	2881952-293
<input checked="" type="checkbox"/> Black	2881965-458	2881041-458	2881952-458
<input checked="" type="checkbox"/> Lime Squeeze	2881965-630	2881041-630	2881952-630
<input checked="" type="checkbox"/> Spectra Orange	2881965-647	2881041-647	2881952-647
<input checked="" type="checkbox"/> Velocity Blue	2881965-689	2881041-689	2881952-689

144"/146" FITMENTS: MY17-19 SWITCHBACK® ASSAULT®, MY17-19 SWITCHBACK® SP, MY17-19 600 VOYAGEUR®, MY17-19 RMK® 144, MY18-19 SKS 146, 155"/163" FITMENTS: 155" A6 163" AXYS® PRO-RMK®, RMK® ASSAULT®, 6 SKS, 174" FITMENTS: MY17-19 PRO-RMK® 174

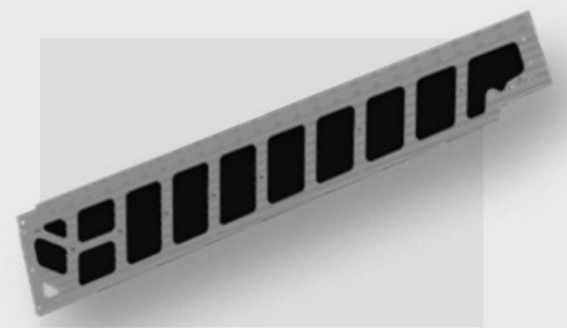

## RUNNING BOARD CLOSE-OUT PLATES

- Aids in water and slush protection when riding in wet conditions
- Premium polyethylene design delivers lightweight protection

2882810  
ALL TITAN™



## TAILLIGHT GUARD

- Protect the top housing of your taillight from stowed gear or accessories
- Rugged aluminum construction secures directly to the rear cargo platform

2882809  
ALL TITAN™

# SKID PLATES

- PROTECTS SUSPENSION AND BULKHEAD
- MADE OF STRONG .695 CM UHMW PLASTIC



PROTECTION: MAXIMUM

MEDIUM

STANDARD

## HIGH COVERAGE AXYS

- Provides the greatest amount of underbelly protection
- Gives a completed and customized look
- Rugged and lightweight UHMW material
- Please note, this may hinder deep snow performance

Black 2882748-070

ALL AXYS® & POLARIS® TITAN™, NOT RECOMMENDED WITH RMK®

## ULTIMATE AXYS

- Enhances protection of belly pan and bulkhead
- Includes all mounting hardware

Black	★ TOP SELLER	2880383-070
White		2880383-133
Red		2880383-293
Blue		2880383-619
Lime Squeeze		2880383-630
Orange		2880383-647

ALL AXYS® & POLARIS® TITAN™

## EXTREME AXYS

- Extended length delivers extra protection for belly pan and bulkhead
- Includes all mounting hardware

Black	2880384-070
White	2880384-133
Red	2880384-293
Blue	2880384-689
Lime Squeeze	2880384-630
Orange	2880384-647

ALL AXYS® & POLARIS® TITAN™

## STANDARD PRO-RIDE

- Adds color and custom style
- Includes all mounting hardware

Black	2878155-070
White	2878155-133
Red	2878155-293

MY11-16 SWITCHBACK® ASSAULT®, ALL INDY®, VOYAGEUR® 155



## KNEE PADS PRO-RIDE

2878195  
ALL PRO-RIDE®



## REAR CRANK FORGING AND SIDE EXTRUSIONS AXYS

- Strong, durable forged aluminum and extruded aluminum
- Bolt-on attachment, replaces stock
- Mounting hardware included

2882121-458

ALL AXYS®, RUSH®, & SWITCHBACK®, DOES NOT FIT SWITCHBACK® ASSAULT®



# HOODS & PANELS



A FLAIR OF COLOR.  
A TOUCH OF ACCENT.  
**COMPLETE YOUR RIDE.**

Hoods and panels have factory-matched coloring, and are an exact replacement for the stock unit.

## PAINTED HOOD

- Design a one-of-a-kind Polaris® AXYS® with a colored hood
- Includes all necessary sound and heat shielding
- Hood does not include headlight or decals





 Indy Red	2882131-293
 White	2882131-599
 Lime Squeeze	2882131-630
 Black Pearl	2882131-666
 Velocity Blue	2882131-689

ALL AXYS® AND POLARIS® TITAN™

## SIDE PANELS

- Design a one-of-a-kind Polaris® AXYS® with colored side panels
- Panels sold individually and do not include decals

### LEFT SIDE PANEL

 Red	5451230-293
 White	5451230-599
 Orange	5451230-647
 Black	5451230-666
 Blue	5451230-689

### RIGHT SIDE PANEL

 Red	5451231-293
 White	5451231-599
 Orange	5451231-647
 Black	5451231-666
 Blue	5451231-689

ALL AXYS® EXCEPT ALL POLARIS® TITAN™. REQUIRES FOAM/FOIL KIT (2635483). DOES NOT INCLUDE QUARTER-TURNS

# WRAPS



WRAPPING YOUR SLED IS EASIER THAN EVER



It all starts with our innovative Polaris® FX Direct pages and SledWrapR application, which allows you to create a customized look for your sled. Simply find your chassis, select your design, and finalize your colors to make the wrap all your own.

BUILD YOURS NOW:  
[POLARIS.COM/AFXWRAPS](http://POLARIS.COM/AFXWRAPS)





# RIDECOMMAND®

## STAY CONNECTED

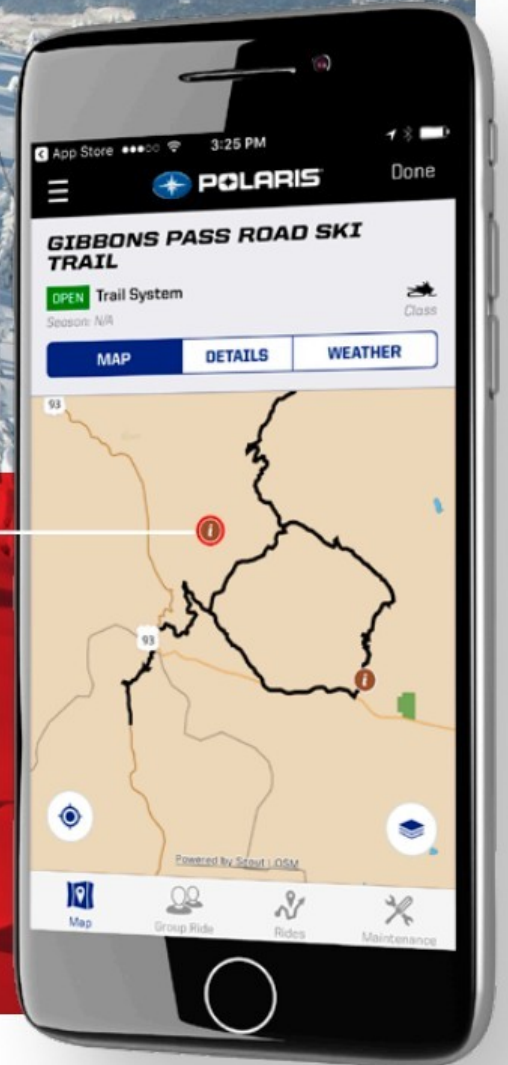

### SEAMLESSLY ENHANCE YOUR SNOWMOBILING EXPERIENCE

Pair your P.I.D.D. with the revolutionary Ride Command® app and enhance your snowmobiling experience by connecting with your friends and your sled. Ride Command®, when paired with a P.I.D.D., allows you to plan rides and coordinate with friends before, during, and after your ride. Also, get quick-glance access to critical snowmobile diagnostic info and GPS navigation. It enhances the features of your P.I.D.D. and allows you to get even more for your ride.

To download the RIDE COMMAND® APP for free, text SN01 to 82350

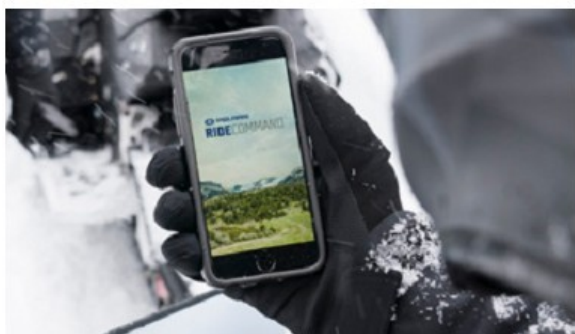

#### CONNECT YOUR DEVICE

- Create a group using the Polaris® Ride Command® app
- Share the snow with fellow riders by inviting a group via social media, text, or email
- Pick a leader in your group to set the "Follow the Leader" feature so you don't get lost on the trail
- Seamlessly enhance your snowmobiling experience



#### CONNECT YOUR FRIENDS

- Track your rides and waypoints, follow your group, and view your vehicle maintenance information
- View the current local weather forecast and snow depth to get ready for your ride



#### CONNECT YOUR SLED

- View trails and update trail maps with the latest 11 cm Polaris® Interactive Digital Display
- Integrates with Polaris® vehicles and the Ride Command® app, giving you the power to monitor and analyze vehicle performance

# P.I.D.D. POLARIS® INTERACTIVE DIGITAL DISPLAY

NEVER PULL OUT YOUR MAP AGAIN



## UPGRADE YOUR RIDE EXPERIENCE

STOCK REPLACEMENT & UPGRADE FOR FACTORY DISPLAY

BRIGHTER, EASY-TO-READ SCREEN

AT-A-GLANCE VEHICLE DATA AND DIAGNOSTICS, INCLUDING FAULT CODES

GPS MAPPING WITH ROUTE AND WAYPOINT RECORDING

BLUETOOTH™ FUNCTIONALITY WITH SMARTPHONE CONNECTIVITY

VEHICLE SECURITY FUNCTION

### POLARIS® INTERACTIVE DIGITAL DISPLAY (P.I.D.D.)

- Bright, easy-to-read 11 cm full-color LCD screen
- GPS Course up or North up option
- GPS Go-to function with distance on map screen
- Exporting capabilities for trip data from the display to USB drive
- TPS, RPM, and ground speed playback for snowmobile tuning, including clutch calibration
- Real-time gauge with speed, RPM, and average MPG
- Phone connectivity shows incoming calls, texts, battery life, and signal
- Toggle through display modes with handlebar control

2881554

MY15-19 AXYS®, MY10-19 PRO-RIDE® (EXCLUDING 550 MODELS). MUST ORDER INSTALL KIT WITH DISPLAY. REQUIRED PARTS TO INSTALL FOR POLARIS® INTERACTIVE DIGITAL DISPLAY

### P.I.D.D. INSTALL KIT

AXYS | 2880493  
ALL AXYS® (DOES NOT FIT POLARIS TITAN™)

PRO-RIDE | 2880495  
REQUIRES ULTIMATE DEFROST BAG (2879090)

2883844  
ALL POLARIS® TITAN™

FURTHER ENHANCEMENTS WHEN PAIRED WITH RIDE COMMAND® INCLUDING GROUP RIDE FUNCTION AND LOCAL WEATHER INFORMATION

## DON'T HAVE AN ELECTRIC START?

FOR A BETTER EXPERIENCE WITHOUT ELECTRIC START, INSTALL THE P.I.D.D. POWER UP KIT

- ADVANTAGES INCLUDE:**
- Maintain GPS lock when you start your sled back up (Without battery kit, satellite will need to relocate, which can take up to 30 seconds while moving)
  - Display will not shut down and reboot every time your sled is shut off
  - Display has ability to run while sled is turned off, which allows you to use the screen while stopped

### P.I.D.D. POWER UP KIT

2882200  
BATTERY SOLD SEPARATELY (4013045) ON P. 79



# HANDLEBARS

## PROTAPER® HANDLEBAR WITH HEATED GRIPS

- ProTaper® handlebar allows riders to customize their handlebar height for their riding style
- Handlebar hooks sold separately (2872482-070)

12.7 cm Rise | Black | 2881235

15.2 cm Rise | Anodized Gray | 2881236

17.7 cm Rise | Silver | 2881237

MY11-19 PRO-RMK®, MY11-19 RMK® ASSAULT®, MY16-19 SKS, MY11-16 PRO-RIDE® SWITCHBACK® ASSAULT®

12.7 cm Rise | Black | 2883835

15.2 cm Rise | Anodized Gray | 2883836

17.7 cm Rise | Silver | 2883837

ALL AXYS® RMK® WITH 850 ENGINE

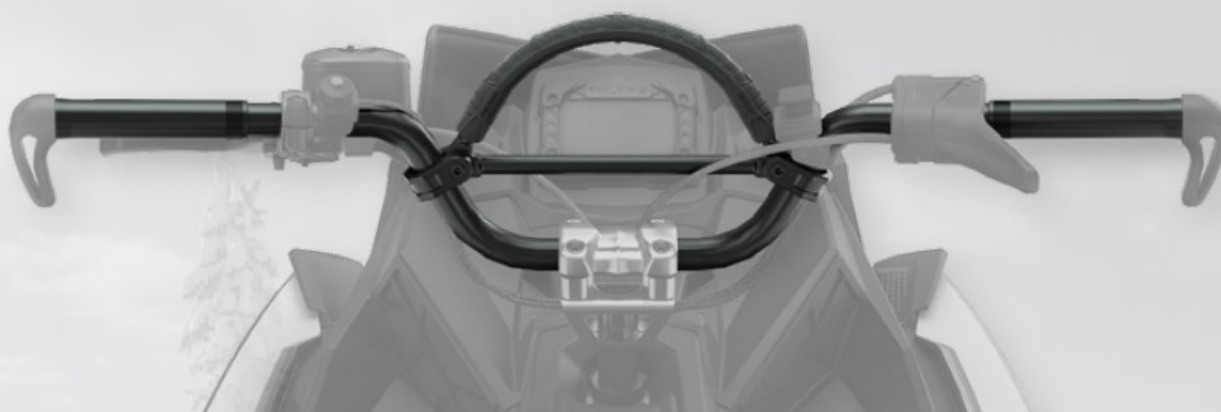

### HANDLEBAR ACCESSORIES



#### MOUNTAIN HOOP

2882118

ALL STRAIGHT BAR APPLICATIONS

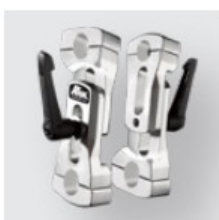

#### ROX® ADJUSTABLE BAR RISER

2881410

ALL AXYS® STRAIGHTBAR APPLICATIONS  
Increase handle bar height from 2.5" to 4"



#### HANDLEBAR HOOK

2872482-070

DOES NOT FIT PROTAPER® BARS

## HANDGUARDS



### POLARIS® HANDGUARDS

- Durable, impact-resistant plastic
- Mounts required; sold separately

Red | 2879193

Black | 2879192 ★ TOP SELLER

White | 2879194

ONLY COMPATIBLE WITH LOW WINDSHIELDS

#### REQUIRES A MOUNT



★ TOP SELLER

#### HANDGUARD MOUNTS

- Strong mounts ensure proper handguard installation
- Easy install: Mounts directly onto handlebar

2880939

ALL STRAIGHT BAR APPLICATIONS, EXCLUDES ALL 550 INDY® AND VOYAGEUR® MODELS

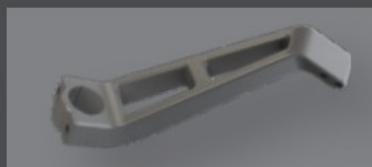

#### RMK® HANDGUARD MOUNTS

- Strong mounts ensure proper handguard installation
- Installs securely on any ProTaper® handlebar

2881241-458

ALL PROTAPER® BARS. FOR FITMENT OF MY10-15 PROTAPER® BARS PROTAPER® FOAM WILL NEED TO BE NARROWED OR REMOVED

## MIRRORS



★ TOP SELLER

### MIRRORS

- Wide-angle view; non-fogging glass
- Folding design for use with cover
- Includes mounting hardware

Pair | 2880292

ALL AXYS®



### HANDLEBAR MIRRORS

- Can be used with stock handlebar pad

Pair | 2876297

ALL PRO-RIDE®



### HOOD MOUNT MIRRORS

- Wide-angle view; non-fogging glass
- Folding design for use with cover
- Includes mounting hardware

Pair | 2877803

ALL PRO-RIDE®





## KEY-OPERATED ELECTRIC START KIT

- The ultimate convenience feature you can add to your sled
- Easier to use and more consistent than pull starts
- Ideal for extreme cold conditions
- Battery required and not included

2881243

ALL AXYS® PRO-RMK®, SKS 155, AXYS® RMK® ASSAULT®

2880396

ALL AXYS®, RUSH®, SWITCH-BACK®, AXYS® RMK® 144 600, AXYS® 146 SKS, & AXYS® INDY®

2883849

ALL 850 ENGINES

2879330

ALL PRO-RIDE® INCLUDES 600 INDY®, 600 VOYAGEUR®

2879833

VOYAGEUR® 550, INDY® 550



## BATTERY (REQUIRED FOR ELECTRIC START KITS)

Sealed, Non-Spill | 4013045  
ALL AXYS®, PRO-RIDE®



## TETHER SWITCH

- Shuts off vehicle if you're separated from it
- Easy to install
- Mounts directly on pod, connects to prewired harness

2874379

ALL 550, 600, 800 ENGINES, ALL AXYS®, ALL PRO-RIDE®

2883823

ALL 850 ENGINES



## 12 VOLT / RCA PLUGS

- 12V accessory plugs into 12-volt outlet, great for GPS or phone, dash mount
- RCA adapter allows you to plug in a heated face shield
- RCA power plug includes all hardware required to add an RCA outlet

12V **★ TOP SELLER** | 2878475

RCA Adapter | 2883824

ALL 850 ENGINES

RCA Adapter | 2878227

ALL 550, 600, 800 ENGINES, ALL VEHICLES WITH 12V OUTLET (2878475) INSTALLED

RCA Power Plug (NOT SHOWN) **★ TOP SELLER**

2878780

ALL AXYS® 600/800 ENGINES, ALL PRO-RIDE®, ALL IQ®

## GAUNTLETS



### DRIVER GAUNTLETS **NEW**

2883716

FITS ALL STRAIGHTBAR APPLICATIONS



### PASSENGER GAUNTLETS **NEW**

2883573

FITS VERSA TOURING PASSENGER SEAT AND FT2 PASSENGER SEAT - FOUND ON PG 66.



### UNIVERSAL FORMED HANDLEBAR GAUNTLETS

- Durable exterior with removable insert
- Gauntlet slides over handgrip; Velcro® strap

2879796

FITS ALL HANDLEBARS

# COVERS



Only Polaris® offers a tailored solution for your sled with unmatched reliability and performance

## PREMIUM POLYESTER

- Polyester construction provides extremely durable protection from the elements, especially while trailering
- Fits full range of windshield heights
- Includes integrated straps and hardware
- Coated to repel water and resist UV degradation
- Tested over thousands of miles by Polaris®
- Redesigned stitching for more durability

PRO-RIDE  
AXYS

PRO-RMK® / SKS	¾	2881042
RMK® ASSAULT®	¾	2881042
RUSH®	¾	2880431
SWITCHBACK®	¾	2880431
SWITCHBACK® ADVENTURE®	¾	2880431
RUSH®	Full	2882223
SWITCHBACK®	Full	2882224
SWITCHBACK® WITH RACK / ADVENTURE®	Full	2882225
SWITCHBACK® 144	Full	2882133
PRO-RMK® 155 / SKS 146/155	Full	2882133
RMK® ASSAULT® 163/174	Full	2882134

## CANVAS

- 283.5 gram canvas construction provides durable protection from the elements
- Fits full range of windshield heights
- Coated to repel water and resist UV degradation
- Form-fitting elastic cinch design
- Tested over thousands of miles by Polaris®
- Redesigned stitching for more durability

PRO-RIDE  
AXYS

RUSH® / SWITCHBACK® WITH SPORT RACK	Full	2882136
RUSH®	Full	2882135
SWITCHBACK®	Full	2882137
SWITCHBACK ADVENTURE® WITH RACK	Full	2882138
SWITCHBACK® 144 <b>★ TOP SELLER</b>	Full	2881969
PRO-RMK® 155 / SKS 146/155	Full	2881969
RMK® 163/174	Full	2881980
INDY® 121 / INDY EVO™	Full	2878725
550 INDY® 144	Full	2879845
INDY® VOYAGEUR® 144	Full	2879845
550 INDY® ADVENTURE 144 - 155	Full	2879844
INDY® LXT	Full	2880515
INDY® VOYAGEUR® 144/155 WITH 2-UP SEAT	Full	2880515
INDY® VOYAGEUR® 155	Full	2880516



## UNDERCOVER

- Made to go under Polaris® snow covers to provide an additional level of protection
- Soft fabric helps to minimize cosmetic damage caused by chafing
- Easy to install and remove
- Works well as a dust cover when machine is stored inside
- The undercover is separate from the cover, which allows it to be kept clean by machine washing. We recommend using a washing machine bag to contain the elastic and hooks
- Air dry

2881981  
ALL AXYS®



## CONVERTIBLE COVERS

- Expandable zippered areas allow for multiple accessory configurations with a single cover
- Our most rugged snowmobile cover for the most demanding applications
- High-quality canvas fabric and form-fitting design is ideal for towing or storage

2882800  
ALL TITAN™

2883568 **NEW**  
ALL AXYS® 129, 144 & 146



# CALIBER™ RAMP PRO

The industry's most innovative ramp design for snowmobiles, ATVs, UTVs, and golf carts.

### ULTIMATE TRACTION AND GLIDE



- 132 cm wide and 229 cm long
- 680 kg rating

2883005

### FINGERS



### INTEGRATED FEET



SELF-RETRACTING STRAP INCLUDED

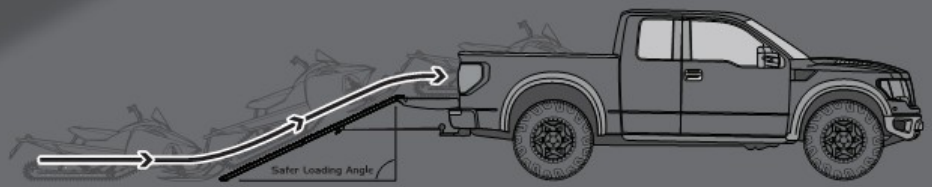

2.3 m = SAFER LOADING ANGLE



### NEW

## CALIBER™ SNOW DOLLY

- New 7.6 cm big wheel caster design
- Move your sled around the garage with ease

RED | 2883852  
GRAY | 2883853

# SKIS

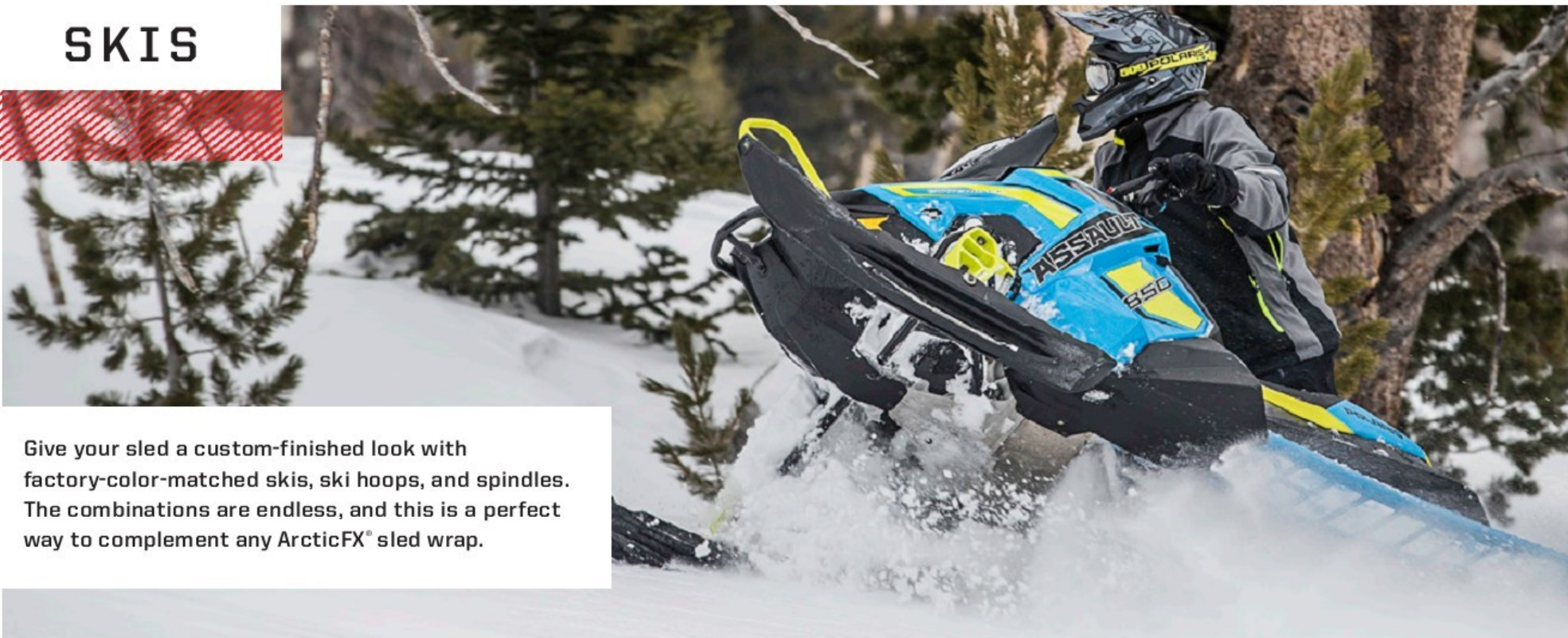

Give your sled a custom-finished look with factory-color-matched skis, ski hoops, and spindles. The combinations are endless, and this is a perfect way to complement any ArcticFX® sled wrap.



## MOUNTAIN

### GRIPPER SKI AXYS® PRO-RIDE®

- Deep, 3.8 cm keel provides positive steering in deep, loose mountain snow
- Wide, 17.2 cm ski delivers increased flotation
- Top traction surface for boot stepping on ski
- Includes black ski toe and hardware; carbide skags required (sold separately; see chart)
- Sold individually

Black	2877679-070
Red	2877679-293
White	2877679-570

ALL AXYS®, ALL PRO-RIDE®

## UTILITY

### PRO-FLOAT SKI AXYS® PRO-RIDE®

- Adapted, 24.1 cm wide PRO-Steer ski design provides 45% more flotation for off-trail deep snow performance
- Includes black ski toe
- Sold individually

Black	2880482
-------	---------

ALL AXYS®, ALL PRO-RIDE®

## TRAIL

### PRO-STEER SKI AXYS® PRO-RIDE®

- Engineered keel design and shortened skag perfect for the trail
- Supportive ribs for torsional stiffness
- No-slip traction atop ski
- Alternate ski stop may be required
- Includes black ski toe and hardware
- Sold individually

Black	2879152-070
White	2879152-133
Red	2879152-293

ALL AXYS®, ALL PRO-RIDE®



### POLARIS® SKI HOOPS

- Adds custom style
- Reliable high-test tie down; secure sleds quickly and confidently

ALL POLARIS® SKIS

Black	2876062-070
White	2876062-133
Red	2876062-293
Lime Squeeze	2876062-630
Orange	2876062-647
Blue	2876062-689



### SPINDLES

- Strong, lightweight aluminum construction with same tolerances as stock spindles
- Colored finish resists chipping and wear
- Exact replacement for stock RMK® spindles
- Color-matched spindles add a custom look to snowmobile

	RUSH®/ SWITCHBACK®	PRO-RMK®
Red	2881409-293	2881437-293
Black	2881409-458	2881437-458
Lime Squeeze	2881409-630	2881437-630
Orange	2881409-647	2881437-647
Blue	2881409-689	2881437-689

MY15-19 RUSH® 6 SWITCHBACK®, MY17-19 SWITCHBACK® ASSAULT®, ALL AXYS® RUSH®, SWITCHBACK®, INDY® 129, 6 TITAN®, SKS 155 '19, SKS 146 '19, RMK® ASSAULT® '19, MY16-18 PRO-RMK® 6 SKS

# OPTIMIZING TRACTION AND CONTROL

	SKIS	CARBIDES	TRACK/STUDS
<b>MOUNTAIN</b>	Add Gripper Skis for a deeper keel, greater flotation, and positive steering in deep, loose snow.	For added trail capability, use 10.2 cm carbides.	Run a deeper lug and more aggressive track pattern to accommodate softer, deeper snow.
<b>CROSSOVER</b>	Choose PRO-Steer Skis if you prefer more trail riding or Gripper Skis if you use trails to get to your next jump-off point.	For improved cornering without compromising deep-snow performance, use 15.2 cm carbides.	Choose a track with a lug depth between 3.4 and 4.4 cm. If you ride off-trail more, choose the lug depth that works for the depth of snow.
<b>TRAIL</b>	For true trail performance, add the Polaris Engineered™ PRO-Steer Ski—specially designed with a low-profile keel.	Dual-runner carbides like the Dooly or Slim Jim reduce darting while increasing corner performance and stability in and out of the apex.	Choose a track based on your sled's rail length and add the number of studs based on your sled model and whether you're a trail, performance, or intermediate rider.

## CARBIDE WEAR STRIPS

Carbides need to be replaced periodically due to normal wear and use. Rocks, cement, pavement, and road crossings all contribute to carbide wear.

## CHOOSE YOUR LENGTH

3" - 4" CARBIDE

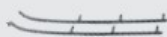

- Perfect for sleds with a 121" track with 96 studs or less or sleds with 2.5 cm lugs taking corners at moderate speeds.

6" CARBIDE

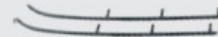

- Ideal for sleds in the 136" track range with up to 3.175 cm lugs or shorter track sleds with more than 96 studs.

8" CARBIDE

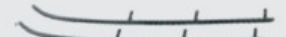

- Best for ultimate performance sleds with a 144" track or longer with paddles and/or the maximum amount of studs.

SKI TYPE	NOTE	STYLE	7.6CM CARBIDE	10.2CM CARBIDE	15.2CM CARBIDE	20.3CM CARBIDE
PRO-Steer Ski	Sold Individually	60"	-	2879025	2879026	2879027
Gripper Ski	Sold Individually	60"	2875723	-	2877880	2877881
RUSH® Ski	Sold Individually	60"	-	2878524	2875613	2875614
Sidehiller Ski	Pair	60"	-	2874334	2875146	-
Polaris® Race Ski	Pair	60"	-	2875142	2875143	-
Youth 120	Pair	60"	2870997	-	-	-

\*Accu-trak Dual Runners fit Saddleless Ski only and are sold as single wear bars



## BITEHARDER® CARBIDE SHARPENER

- Designed to be used with portable drill for sharpening anywhere
- Carbide wear bar sharpening tool for use on the trail or in the shop
- Quickly and easily puts a fresh edge on wear bars for improved handling
- Delivers more precise and accurate handling, especially in the corners
- Features long-lasting V-shaped, diamond-coated sharpening stone
- Long-lasting diamond media can sharpen up to 40 wear bars

2882952



# SHOCKS

TRAIL



## WALKER EVANS® TRAIL PERFORMANCE SHOCKS

- External hi/lo ProDial compression damping adjustment
- Piggyback reservoir provides increased oil and nitrogen volumes for fade-free performance
- Velocity- and position-sensitive needle damping
- Ultra-progressive MCU bump stop
- 100% designed, engineered, and manufactured in the U.S.A.
- Fully rebuildable and revalveable

IFS (EACH)\*

2881946

SWITCHBACK® ADVENTURE® '19, MY15-19 AXYS® RUSH® & SWITCHBACK® 137, MY17-18 AXYS® SWITCHBACK® ASSAULT®, SWITCHBACK® SP, INDY® XC '19, INDY® SP '19

FRONT TRACK\*

2881947

SWITCHBACK® ADVENTURE® '19, MY15-19 AXYS® RUSH® & SWITCHBACK® 137, MY17-18 AXYS® SWITCHBACK® ASSAULT®, SWITCHBACK® SP, 600 VOYAGEUR® 144, 600 RMK® 144, INDY® XC '19, INDY® SP '19

REAR TRACK\*

2881948

SWITCHBACK® ADVENTURE® '19, MY15-19 AXYS® RUSH® & SWITCHBACK® 137, SWITCHBACK® '19, INDY® XC '19, INDY® SP '19

CROSSOVER



## FOX® SWITCHBACK® SHOCKS

- Quick Switch 3 compression dial makes for quick adjustments for changing conditions
- Coil over air shock design
- 6061 aluminum body with anodized finish

IFS (EACH)\*

2881411

MY15-18 AXYS® RUSH® & SWITCHBACK® 137, MY17-19 AXYS® SWITCHBACK® ASSAULT®, SWITCHBACK® SP

FRONT & REAR TRACK SHOCK SET\*\*

2881412

MY15-18 AXYS® RUSH® AND SWITCHBACK® 137

MOUNTAIN



## WALKER EVANS® CROSSOVER SHOCK

- Velocity- and position-sensitive needle damping
- 16-way compression adjuster to fine-tune ride through changing conditions
- Piggyback reservoir provides increased oil and nitrogen volumes for fade-free performance
- Progressive MCU bump stop

IFS (EACH)\*\*\*

2881970

MY15-19 AXYS® RUSH® AND SWITCHBACK® 137, MY17-19 SWITCHBACK® ASSAULT®, AND SWITCHBACK® SP

FRONT TRACK\*\*\*

2881971

MY15-19 AXYS® RUSH® AND SWITCHBACK® 137, MY17-19 SWITCHBACK® ASSAULT®, SWITCHBACK® SP, 600 VOYAGEUR® 144, 600 RMK® 144

REAR TRACK\*\*\*\*

2881972

MY17-19 SWITCHBACK® ASSAULT®, SWITCHBACK® SP, 600 VOYAGEUR® 144, 600 RMK® 144



## ÖHLINS® HIGH PERFORMANCESHOCKS

- P-Type Shocks with springs included. Fully re-buildable.
- Adjustable compression and rebound adjuster.
- SWB shocks are updated for 2019 models.
- High

\*ÖHLINS SHOCKS FOR TITAN IS AVAILABLE. CONTACT YOUR NEAREST DEALER (SWB ASSAULT, NO SPRING INCLUDED)

PB610 | FRONT PRO RMK 36" (PAIR), 19 Q-ADJUST  
 PB607 | FRONT RMK/SKS 17-19 (PAIR), 800 SKS 146"19  
 PB608 | CENTER RMK/SKS 17-19  
 PB609 | REAR RMK/SKS 17-19  
 PB614 | FRONT SWB ASSAULT 17-19 (PAIR)  
 PB615 | CENTER SWB ASSAULT 17-19 | SKS 146" 19  
 PB616 | REAR SWB ASSAULT 17-19, SKS 146" 19 (36)  
 MN920 | ÖHLIN FRONT 46PRC INDY 129"19-  
 MN919 | ÖHLIN REAR 46PRC INDY 129" 19-  
 MN918 | ÖHLIN CENTER 46PRC INDY 129" 19-



## WALKER EVANS® AXYS® DEEP SNOW PREMIUM SHOCK

- 16-way compression adjuster to fine-tune ride through changing conditions
- Lightweight 6061 T6 extruded aluminum alloy design
- Piggyback reservoir provides increased oil and nitrogen volumes for fade-free performance
- Front track shock features an internal floating piston monotube for consistent, fade-free performance
- 100% designed, engineered, and manufactured in the U.S.A.
- Fully rebuildable and revalveable

IFS (NEED TWO)

2881058

INCLUDES MOUNTING HARDWARE, DOES NOT INCLUDE COIL OVER SPRING

AXYS® PRO RMK®, SKS 155 '19, SKS 146 '19, RMK® ASSAULT® '19, PRO-RMK® '19

REAR TRACK

2881059

INCLUDES MOUNTING HARDWARE AND COIL OVER SPRING

AXYS® PRO RMK® SKS 155 '19, SKS 146 '19, RMK® ASSAULT® '19, PRO-RMK® '19

NEW



## RMK® SLS SUSPENSION SPRINGS

- Lighter than titanium
- 1.4 kg weight reduction over stock springs
- Increased performance over stock springs

FRONT IFS SHOCK SPRINGS

2883682-458

ALL PRO-RMK® '16-'19, MY16-19 SKS 155

TRACK SHOCK SPRINGS

2883715-458

ALL PRO-RMK® '16-'19, SKS 155 '16-'19

NEW



## INDY® EVOLution KIT

- Comes with everything you need to evolve your INDY EVO™ as the rider's skill increases
- Includes tie rods, control arms, spindles, shocks, and more!

2883939

INDY EVO™



# STUDS

RIP WITH AN **IRON GRIP**: Track studs allow you to dominate terrain as far and as fast as you can see. The right stud improves acceleration, braking, steering, and control, especially on hard-packed snow and ice. The more aggressive your riding style, the more traction your sled needs to perform at its best.

### CHOOSING THE RIGHT STUD

1. Determine your riding style and terrain.
2. Find sled model info and number of studs required.
3. Determine length of turning carbides to balance traction and steering.
4. Make sure the studs won't interfere with your tunnel or cooling system.



## STUDS AND WEAR STRIP FIT CHART

MODEL	TRACK	TRACK LENGTH (CM)	LUG HEIGHT (CM)	STUD SIZE (CM)	WEAR STRIP KIT	STUD QUANTITY			
						TRAIL	INTERMEDIATE	PERFORMANCE	
PRO-RIDE	550 INDY® LXT 144	5414190	38.1 X 365.8	2.5	2.7	2879831	108	144	162
	550 INDY® LXT 144 INT	5414013	38.1 X 365.8	3.4	3.4/3.7	2879831	144	152	171
	550 INDY® Adventure®	5414013	38.1 X 365.8	3.4	3.4/3.7	2879831	144	152	171
	550 INDY® 121	5412281	38.1 X 345.4	2.3	2.7	2879830	108	144	162
	550 INDY® 144	5414013	38.1 X 365.8	3.4	3.4/3.7	2879831	144	152	171
	550 INDY® Voyageur® 155	5414902	38.1 X 393.7	4	Not recommended	2879831	144	152	171
	600/800 INDY®	5412281	38.1 X 307.3	2.3	2.7	2879212	96	144	162
	600/800 INDY® SP	5413198	38.1 X 307.3	2.5	2.7	2879212	96	144	162
	600/800 RUSH®	5413198	38.1 X 307.3	2.5	2.7	Standard	96	144	162
	600 RUSH® PRO-RIDE®	2875512	38.1 X 307.3	3.2	3.4	Standard	96	144	162
	600 SWITCHBACK®	2875639	38.1 X 345.4	3.2	3.4	Standard	108	144	162
	800 RUSH®	5413198	38.1 X 307.3	2.5	2.7	Standard	96	144	162
	800 RUSH® PRO-RIDE®	2875512	38.1 X 307.3	3.2	3.4	Standard	96	144	162
	800 RUSH® PRO-RIDE® LE	2877377	38.1 X 307.3	3.4	3.4/3.7	Standard	96	144	162
	800 SWITCHBACK®	2875639	38.1 X 345.4	3.2	3.4	Standard	108	144	162
	800 SWITCHBACK® PRO-RIDE®	2877678	38.1 X 345.4	3.4	3.4/3.7	Standard	108	144	162
	MY17-19 AXYS® 144"	5414013	38.1 X 365.8	3.4	3.4/3.7	2881605	144	152	171
	AXYS	600/800 RUSH®	5414653	38.1 X 304.8	3.2	3.4	Standard	108	144
600/800 RUSH®		5414894	38.1 X 304.8	4.5	Not recommended	Standard	-	-	-
600/800 RUSH®		2877748	38.1 X 304.8	3.4	3.4	Standard	-	-	-
600/800 SWITCHBACK®		5414654	138.1 X 348	3.2	3.4	Standard	108	144	162
600/800 SWITCHBACK®		5414895	38.1 X 348	4.5	Not recommended	Standard	-	-	-
600/800 SWITCHBACK®		5413661	38.1 X 348	3.4	3.4	Standard	108	144	162

### 96 PACK STUDS

TRACTION MASTER® 5/16 | 96 PACK  
3.7 cm | 2879139

SIGNATURE SERIES 5/16 | 96 PACK  
2.7 cm | 2875155

SIGNATURE SERIES 5/16 | 96 PACK  
3.4 cm | 2875149

SIGNATURE SERIES 5/16 | 96 PACK  
3.7 cm | 2879161

### 144 PACK STUDS

Signature Series 5/16 | 144 Pack  
3.7 cm | 2879162

### WEAR STRIP KITS

- Protects tunnel when installing studs
- Made of ultra-durable UHMW material

MY11-15 550 LXT  
2877687

MY13-15 600/800 INDY®  
2879212

MY11-16 SWITCHBACK® ASSAULT®  
2878161

550 INDY® 144, VOYAGEUR®  
2879831

550 INDY® 121  
2879830

MY17-19 SWITCHBACK® ASSAULT®  
2881605

K-WEAR STRIP 155 TITAN®  
2882880

INDY® XC 129  
2883572

### ALUMINUM BACKER PLATES

ROUND | 24 PACK | 5/16  
2874324

ROUND | 96 PACK | 5/16  
2874325

ROUND | 1,000 PACK | 5/16  
2874329

SQUARE | 96 PACK | 5/16  
2873153



### TRAIL BOGIE WHEELS

Solid Bogie  
Wheel-External Rail

**2881955**  
INCLUDES 4. MY15-18 AXYS® RUSH® AND SWITCHBACK®, MY17-18 ASSAULT® 144, MY17-18 SWITCHBACK® SP 144, MY17-18 600 VOYAGEUR®

Solid Bogie  
Wheel-Internal Rail  
**2881956**

INCLUDES 2. MY15-18 AXYS® RUSH® AND SWITCHBACK®, MY17-18 ASSAULT® 144, MY17-18 SWITCHBACK® SP 144, MY17-18 600 VOYAGEUR®

XCR™ Rear Axle Wheel Kit  
**2881954**  
4 WHEELS & SPACER INCLUDED. MY15-18 AXYS® RUSH® AND SWITCHBACK®

144/146 HD Rear Skid Upgrade Kit  
**2882916**  
KIT INCLUDES 4 AXLE WHEELS AND RAIL STIFFENERS

Low Snow Kit  
**2882802**  
POLARIS® TITAN™



### ICE SCRATCHERS

- Direct ice chips into skid to lube and cool hi-fax
- Permits wheel removal on SKS 155, saving 1.8 kg

**2882028**  
AXYS® PRO-RMK®, ASSAULT® RMK®, SKS 155, COMES STANDARD ON AXYS® PRO-RMK®, ASSAULT® RMK®

**2876256**  
PRO-RIDE® RMK®, RMK® ASSAULT®



### RMK® BOGIE WHEEL KIT

- Wheels install on stock skid
- Reduces hi-fax wear on hard pack snow and ice
- Sold in pairs
- A total of 3 pairs can be installed onto a stock skid

**2882048**  
AXYS® PRO-RMK® 174, AXYS® PRO-RMK®, ASSAULT® RMK®, SKS. COMES STANDARD ON SKS 155

**2878251**  
PRO-RIDE®



### XCR TORSION BAR KIT

- Reduces body roll when cornering

**2881950**  
MY15-18 AXYS® RUSH® AND SWITCHBACK®

# TRACKS



## FEEL THE DIFFERENCE

A snowmobile's track is a major component to performance. We build tracks for specific needs—whether you climb the highest peaks, carve the tightest trails, or race against the toughest competition. From improved acceleration, to better handling, to increased traction in deep snow, dial in your ride.

## TRAIL



COBRA



- Cupped lugs for superior acceleration and braking in loose, soft snow conditions
- Flexible lug design for superior off-trail performance

LENGTH	PITCH	LUG HEIGHT	
305	7.3	3.4	2839284
307	6.4	3.4	2839052
328	7.3	3.4	2839235
345	6.4	3.4	2839061
348	7.3	3.4	2839093
348	7.3	3.4	2839307
348	7.3	3.4	5413661
366	6.4	3.4	2839107
366	7.3	3.4	5414013
366	7.3	4	5416162
394	7.3	3.8	5415826
394	7.3	4.6	5416020



STORM 150 **NEW**



- 3.2 cm outer lugs provide power through the tightest turns with ease, maintaining momentum and rider control
- 3.8 cm cup-shaped center lugs provide deep snow flotation, and gut-wrenching acceleration on packed trails
- Optimized support columns provide the right balance of lug rigidity and flex for performance across the entire power band

LENGTH	PITCH	LUG HEIGHT	
305	7.3	3.2/3.8	2839368
328	7.3	3.2/3.8	2839369
348	7.3	3.2/3.8	2839370
371	7.3	3.2/3.8	2839371

## CROSSOVER

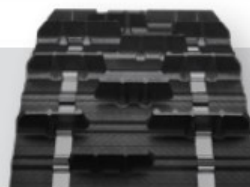

BACKCOUNTRY



- Arched lug design with staggered, snocross-inspired pattern for excellent soft-snow traction

LENGTH	PITCH	LUG HEIGHT	
305	6.4	4.5	5414894
307	6.4	4.5	2839140
307	6.4	4.5	5415097
345	6.4	4.5	2839142
345	6.4	4.5	5414378
348	26.4	4.5	5414895
366	6.4	4.5	2839143
366	6.4	4.5	5415096

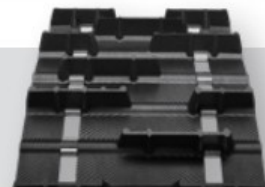

BACKCOUNTRY X



- Arched lug design with staggered, snocross-inspired pattern for excellent soft-snow traction
- All 7.3 cm drive pitch models feature tapered lugs on outside edges for improved durability
- 7.6 cm drive pitch also available

LENGTH	PITCH	LUG HEIGHT	
305	7.3	4.5	2839287
348	6.4	4.5	2839289

## MOUNTAIN



SERIES 7



- Polaris® exclusive
- Ideal track to provide lift in the deepest, softest snow conditions
- Features a new lightweight single-ply design optimized for weight and powder snow performance

LENGTH	PITCH	LUG HEIGHT	
394	7.6	7.6	5415393
414	7.6	7.6	5415394
442	7.6	7.6	5415786



SERIES 6



- Outstanding traction and control in deep snow
- Lugs provide tremendous flotation and great performance
- 6.6 cm lugs provide outstanding traction in all deep snow conditions
- Design provides outstanding flotation and control

LENGTH	PITCH	LUG HEIGHT	
394	7.3	6.6	5415391
414	7.3	6.6	5415392



SERIES 5.1



- Industry-leading deep powder track; for 8T drive sprockets, 7.3 cm pitch
- Optimized lug pattern producing 19% more forward lug contact compared to our Series 5.0 track
- Soft and flexible tips for superior performance in deep snow

LENGTH	PITCH	LUG HEIGHT	
394	7.3	6.1	5413622
414	7.3	6.1	5413621



PEAK 2.25



- Angular lugs bite and funnel snow under the snowmobile for outstanding flotation
- Features soft lugs for powder snow and hard lugs for heavy/wet snow
- Outer lug bars deliver better lateral control for improved handling

LENGTH	PITCH	LUG HEIGHT	
394	7.3	5.7	5415002





## BACKCOUNTRY X2

ON TRAIL OFF TRAIL

- Arched lug design with staggered, snocross-inspired pattern for excellent soft-snow traction
- Rigid lug support columns and optimized rubber compound to deliver great on/off-trail performance
- 7.3 cm drive pitch

LENGTH	PITCH	LUG HEIGHT	
305	7.3	7.3	2839256
328	7.3	7.3	2839257
348	7.3	7.3	2839258



## COBRA 1.6

ON TRAIL OFF TRAIL

- Cupped lugs for superior acceleration and braking in loose, soft snow conditions
- Flexible lug design for superior off-trail performance
- Select lugs are more rigid for traction on hard-packed snow

LENGTH	PITCH	LUG HEIGHT	
305	7.3	4.1	2839291
305	7.3	4.1	5414902
328	27.3	4.1	2839292
348	7.3	4.1	2839264
394	7.3	4.1	5414902
394	7.3	4.1	2839283



## ICE COBRA 1.6

ON TRAIL OFF TRAIL

- Cupped lugs for superior acceleration and braking in loose, soft snow conditions
- Flexible lug design for superior off-trail performance
- Factory pre-studded with 4.1 cm lugs for excellent all-round performance, especially on ungroomed trails

LENGTH	PITCH	LUG HEIGHT	
305	7.3	4.1	2839244
348	7.3	4.1	2839246
394	7.3	4.1	2839273



## CHALLENGER

ON TRAIL OFF TRAIL

LENGTH	PITCH	LUG HEIGHT	
307	6.4	5.1	2839798
345	6.4	5.1	2839797
348	7.3	5.1	2839186
366	6.4	5.1	2839875
371	7.3	6.4	2839145
384	6.4	5.1	2839876
389	7.6	6.4	2839174
391	7.3	6.4	2839104
396	7.6	8.1	2839320
411	7.6	8.1	2839175
411	7.6	6.4	2839319
414	7.3	6.4	2839105



## RIPSAW

ON TRAIL OFF TRAIL

- Rigid lugs provide superior handling, acceleration, and braking on groomed trails
- Narrow lug base for reduced rolling resistance and maximum top speed
- Angled profiles for aggressive forward and lateral bite

LENGTH	PITCH	LUG HEIGHT	
305	7.3	3.2	2839149
307	6.4	3.2	2839146
307	6.4	3.2	2839968
307	6.4	3.8	5413384
325	6.4	3.2	2839001
325	6.4	3.2	2839215
345	6.4	3.2	2839969
345	6.4	3.8	5413543
348	7.3	2.5	2839234
394	7.3	3.5	5416227



## RIPSAW 2

ON TRAIL OFF TRAIL

- Tapered outside lug edges for less side bite when cornering
- Sharp angled lugs for excellent bite on hard-pack snow
- Cupped center and full outer lugs for traction on loose, less-compacted snow

LENGTH	PITCH	LUG HEIGHT	
305	7.3	3.2	2839149
305	7.3	3.2	2839209
305	7.3	3.8	2839304
305	7.3	3.2	5414653
307	6.4	3.2	2839214
307	6.4	3.2	5415100
328	7.3	3.8	2839305
345	6.4	3.2	2839216
348	7.3	3.2	2839223
348	7.3	3.8	2839306
348	7.3	3.2	5414654



## SNOW XT

ON TRAIL OFF TRAIL

- Optimized for aggressive riding conditions or snocross racing applications
- Two-ply construction for lower rotating mass and more horsepower to the snow
- 4.6 cm scooped lugs with 6.4 cm pitch for excellent acceleration

LENGTH	PITCH	LUG HEIGHT	
325	6.4	4.6	5450277

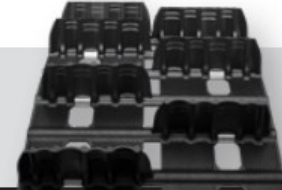

## CONQUER 280

ON TRAIL OFF TRAIL

- Lightweight construction increases available HP due to less rotating mass
- New lug design requires 20% less rider input on turns and 25% less throttle to hold on side hills
- 7.1 cm alternating single-angled lugs push performance in all-season riding conditions

LENGTH	PITCH	LUG HEIGHT	
389	7.6	7.1	2839337
396	7.6	7.1	2839336
411	7.6	7.1	2839335
442	7.6	7.1	2839334

SEE ALL TRACKS OPTIONS AT  
[POLARIS.COM/TRACKS](https://polaris.com/tracks)



## SERIES 5.2

ON TRAIL OFF TRAIL

- Modeled after the modified Series 5.1 track used by Polaris® hillclimb racers
- Provides great traction both on and off trail
- Maintains excellent durability
- Optimized lug pattern for more forward lug contact

LENGTH	PITCH	LUG HEIGHT	
371	7.3	5.7	5416498

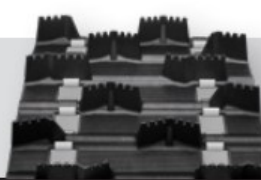

## SERIES 4

ON TRAIL OFF TRAIL

- The standard in 5.1 cm deep snow tracks; for 9T drive sprockets, 6.4 cm pitch
- Equal parts versatility and durability
- Stiff lug base for long wear and hard-pack performance
- Soft and flexible tips for superior performance in deep snow

LENGTH	PITCH	LUG HEIGHT	
366	6.4	5.1	5413073
366	6.4	5.1	5415692



## SHOCK WAVE

ON TRAIL OFF TRAIL

- Designed for hard-working, utility applications
- Able to handle heavy workloads in deep-snow, off-trail environments
- Tackles on-trail, hardpacked applications, too
- 2.5 cm lug height with 6.4 cm pitch

LENGTH	PITCH	LUG HEIGHT	
296	6.4	2.5	5414453

## COMPETITION TRACK

ON TRAIL OFF TRAIL

- Customized for snocross competition
- Developed for, and tested by, top Polaris® racers

LENGTH	PITCH	LUG HEIGHT	
307	6.4	4.6	5413352
371	7.3	5.4	5413490
394	7.3	5.3	2877304

## YOUTH 120

ON TRAIL OFF TRAIL

- Replacement track for the Polaris® 120 INDY®

LENGTH	PITCH	LUG HEIGHT	
173	6.5	1.8	5411751

# FOR THE LIFE OF YOUR RIDE

Maintenance is the key to keeping your Polaris® snowmobile performing at its peak. Items like belts, lubricants, and batteries represent only a few of these critical items engineered specifically by Polaris.



## POLARIS ENGINEERED™ DRIVE BELTS

### TESTED, PERFECTED

*We test each belt on the intended vehicle - we don't just try to make an existing belt "just work".*

- Amery Kuhl, Polaris® CVT System Engineer

### OUR INVESTMENT

- 32,186 km of field testing
- Thousands of dyno hours
- 18+ months of development (3,000+ design hours) per belt
- 1200+ vehicle validation hours
- Collaboration with powertrain & clutch engineers

### YOUR ADVANTAGE

- No clutch recalibration
- Less wear & tear due to heat
- Ensure maximum performance of your vehicle
- More time out riding, less time wrenching

**OUR INVESTMENTS ENSURE POLARIS BELTS  
OUTPERFORM YOUR EXPECTATIONS.**

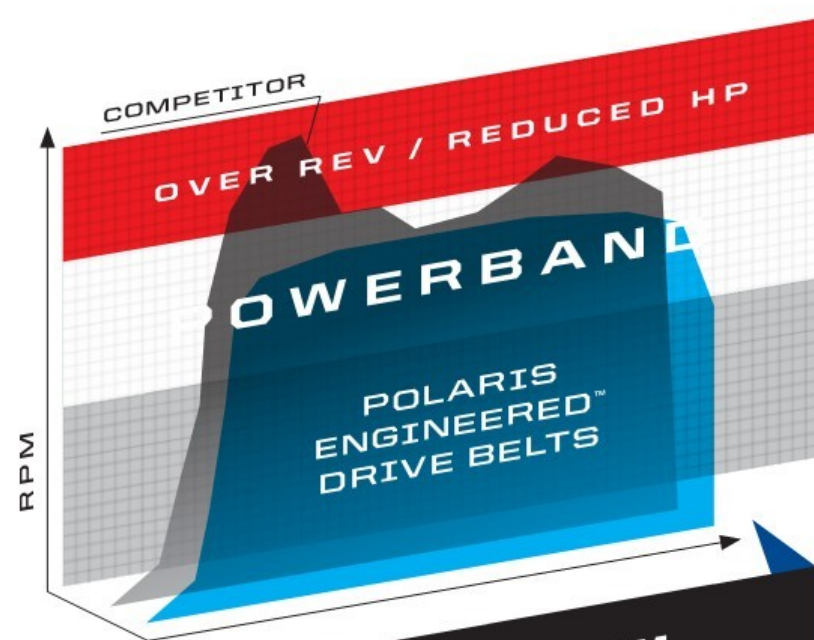

**RUN AT THE OPTIMAL RPM  
WITH POLARIS ENGINEERED™ DRIVE BELTS**

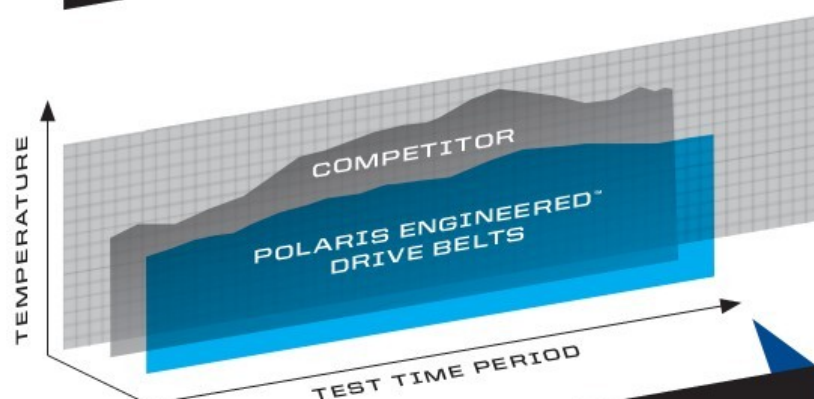

**# 1 REASON BELTS FAIL IS HEAT  
POLARIS BELTS RUN COOLER THAN THE COMPETITION,  
EVEN AT HIGH RPMS**

**AFTERMARKET BELTS RUN HOTTER  
OVERSIZED AFTERMARKET COGS FAIL DUE TO OVER-TRAVEL  
INTO THE DRIVE CLUTCH CREATING HIGH HEAT**

# MAINTENANCE SCHEDULE

CHECK YOUR OWNER'S MANUAL FOR ADDITIONAL RECOMMENDED SERVICE ITEMS AND VEHICLE-SPECIFIC TIMING

## PRE-SEASON

**ENGINE OIL:**  
FILL TO RECOMMENDED LEVEL

**GENERAL LUBRICATION:**  
ALL FITTINGS, PIVOTS, CABLES, ETC.

**CHECK FOR WEAR:**  
TEST, CLEAN & CHECK FLUID LEVELS

SPARK PLUGS, TRACK, SLIDER, DRIVE BELT, & CARBIDES

500 MI (800 KM)

## IN-SEASON

**ENGINE OIL:**  
FILL TO RECOMMENDED LEVEL

**DRIVE BELT:**  
INSPECT & ADJUST  
FOLLOW BREAK-IN PROCEDURE AFTER INSTALLATION

**TRANSMISSION FLUID:**  
CHANGE

2000 MI (3200 KM)

## IN-SEASON

**ENGINE OIL:**  
FILL TO RECOMMENDED LEVEL

**CHECK FOR WEAR:**  
TEST, CLEAN & CHECK FLUID LEVELS  
SPARK PLUGS, TRACK, SLIDER, DRIVE BELT, & CARBIDES

**DRIVE BELT:**  
INSPECT & ADJUST  
REPLACE AS NEEDED

## END OF SEASON

**DRIVE BELT:**  
REMOVE  
CONSULT OWNER'S MANUAL

**FUEL:**  
ADD FUEL STABILIZER

**TRACK:**  
INSPECT  
REDUCE TENSION DURING STORAGE

**BATTERY:**  
REMOVE

CHECK OUT OUR **PARTS FINDER ON POLARIS.COM** FOR EASY PARTS LOOK-UP, PARTS IDENTIFICATION, VIEWS OF ASSEMBLIES, AND MORE!

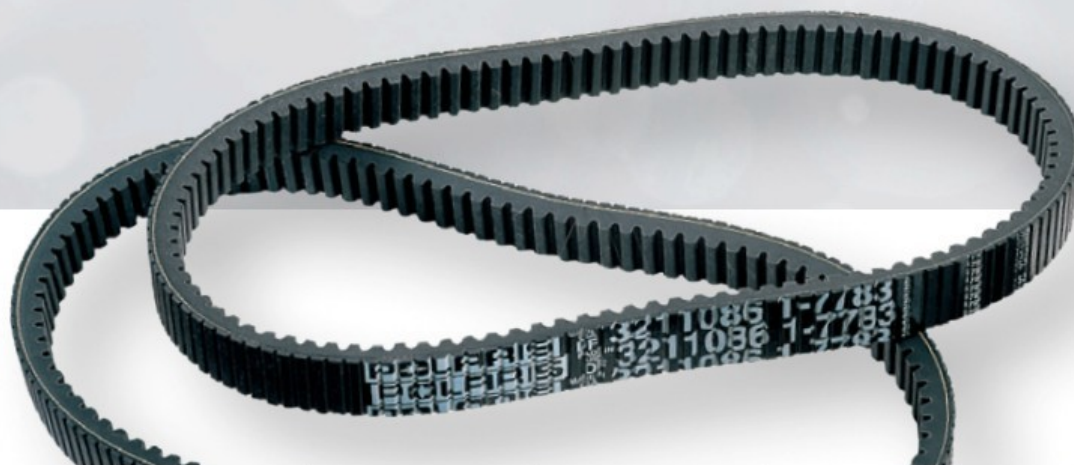

BELT COMPOUND & CONSTRUCTION NOTES	BELT WIDTH*	OUTER CIRCUMFERENCE* (CM)	PART NO.
<b>AXYS® (RUSH®, SWITCHBACK®, SWITCHBACK® ADVENTURE®, SWITCHBACK® ASSAULT®, VOYAGEUR®, POLARIS® TITAN® &amp; INDY® 129)</b>			
HIGH MODULUS CHLOROPRENE BELT	1.46" (37.10mm)	114.7	3211215 (850cc)
PBO BELT	1.46" (37.10mm)	114.7	3211177 (800cc)
PBO BELT	1.46" (37.10mm)	114.7	3211165 (600cc)
<b>AXYS® (PRO-RMK®, RMK® ASSAULT®, SKS)</b>			
HIGH MODULUS CHLOROPRENE BELT	1.46" (37.10mm)	118.8	3211216 (850 cc)
PBO BELT	1.46" (37.10mm)	118.8	3211183 (800cc)
PBO BELT	1.46" (37.10mm)	118.8	3211115 (600cc)
<b>PRO-RIDE® (RUSH®, SWITCHBACK®, SWITCHBACK® ASSAULT®, INDY®, VOYAGEUR®, PRO-RMK®, RMK®, RMK® ASSAULT®)</b>			
PBO BELT	1.46" (37.10mm)	118.8	3211115
KEVLAR® BELT	1.46" (37.10mm)	118.8	3211122
KEVLAR® BELT	1.32" (33.53mm)	109.9	3211174 (550cc)
STANDARD BELT	1.29" (32.77mm)	107.9	3211154 (550cc)

**FIND THE RIGHT BELT FOR YOUR MACHINE IN OUR ONLINE PARTS CATALOG AT POLARIS.COM**

\*Belt dimensions are given in nominal dimensions. There is a +/- variance for all critical dimensions. Clutch setup must be inspected when a new belt is installed and should be adjusted if necessary. The drive belt is an important component in the CVT system. In order to achieve maximum efficiency from the converter, drive belt deflection (tension), clutch offset, and alignment must be adjusted properly. See your Service Manual for further details on drive belt measurement inspection.

## MAINTENANCE



**BATTERIES**  
4013045



**SPARK PLUGS**  
ENGINEERED FOR YOUR POLARIS® SLED

NGK | 3022082  
CHAMPION | 3070190

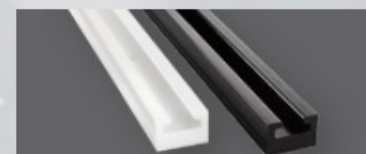

**SLIDERS**  
5521632      5521633-309  
5521633-070      5522144-070

# THE BEST OIL ON SNOW

**POLARIS ENGINEERED™ OILS & LUBRICANTS** are developed, tested, and approved by Polaris® engineering for use in Polaris Snowmobiles. Polaris Engineers rigorously test every fluid before it earns the right to wear the Polaris Engineered Lubricants™ badge. Protect your investment with Polaris Engineered™ Oils & Lubricants.



## 2-CYCLE OIL SYNTHETIC VES

Approved on high output engines with VES valves.  
 » 502078 | 2-Stroke Oil Ves Gold+, synthetic, 1L  
 » 502077 | 2-Stroke Oil Ves Gold+, synthetic, 4 L  
 » 502132 | 2-Stroke Oil Ves Gold+, synthetic, 25 L  
 » 502131 | Barrel, 202 L



## 2-CYCLE OIL BLUE

Approved for all engines without Ves valves.  
 » 502087 | 2-Stroke Semi synthetic oil  
 » 502088 | 2-Stroke Semi synthetic oil  
 » 502141 | 2-Stroke Semi synthetic oil 25 L  
 » 502140 | Barrel, 200 L



## PS-4 PLUS SYNTHETIC OIL

» 502129 | 4-Stroke oil, 1 L  
 » 502120 | 4-Stroke oil, 3,8 L  
 » 502130 | 4-Stroke oil, 25 L  
 » 502125 | Barrel, 200 L



**ALL SEASON GREASE**  
 Polaris grease for all year use.  
 » 502068 | 400g Cartridge, fits all STD grease guns,



## ALL PURPOSE CLEANER

» 502309  
 » Leaves an invisible, dirt resistant barrier for long lasting result. Cuts through grease, dirt, road-film and more.



## INSTANT SHINE

» 502303  
 Cleans, polishes and protects plastic and painted surfaces. Just spray and wipe.

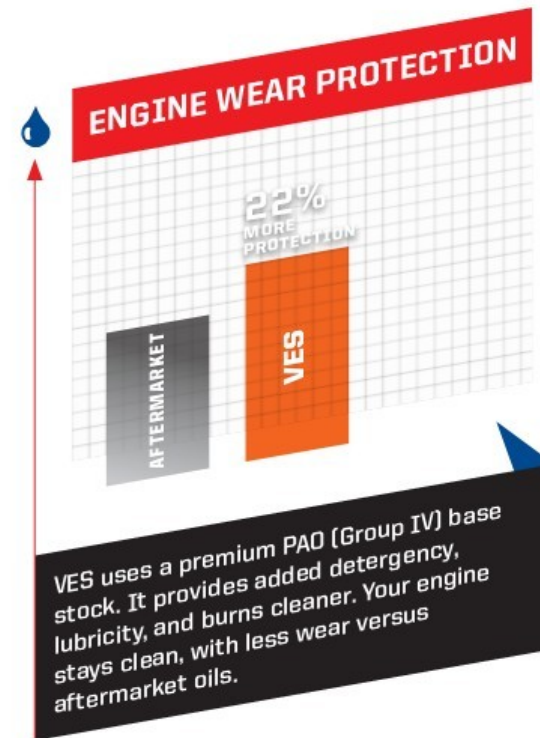
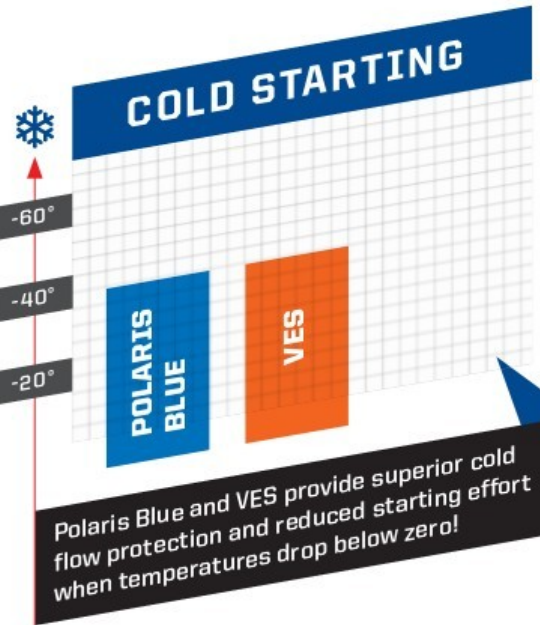

## VES SYNTHETIC 2-CYCLE OIL

Clean-burning, low-odor, smokeless oil formulation designed to improve exhaust valve performance. VES offers maximum engine protection.

- Formulated for easy starting in extreme cold
- Improved rust and corrosion inhibitor package
- Synthetic performance base oil formulation offers excellent load carrying abilities to reduce engine wear
- Provides enhanced valve cleanliness, low smoke & excellent lubricity

## POLARIS® BLUE POLARIS® BLUE 2-CYCLE OIL

Specially formulated synthetic blend 2-cycle engine oil provides excellent protection and performance in all 2-cycle injector or pre-mix non-VES applications.

- Provides superior engine protection and performance in all conditions
- Smokeless formulation, synthetic-blend oil
- Formulated for easy starting in extreme cold



## FUEL TREATMENT

Keeps your fuel system clean from corrosion and deposits  
 » 502100 | Fuel Stabilizer, 125 ml  
 » 502082 | Carbon Clean Plus, with Stabilizer, 125 ml



## CHAIN CASE LUBE

» 502083, 1L



## ANTI FREEZE

» 502103 | Anti Freeze Pre-Mix 1L,  
 502271 | Anti Freeze Pre mix 25 L,

# ENGINEERED TO MAXIMIZE THE LIFE OF YOUR RIDE

All Polaris® fluids—from anti-freeze to brake fluid—are developed for your vehicle. Trust the only fluids perfectly engineered for your needs.

## CARBON CLEAN

Polaris® Carbon Clean prevents ethanol corrosion, stabilizes fuel, and cleans carburetor jets and fuel injector nozzles, deposits on piston and rings, intake systems, and combustion chambers. Antioxidants preserve fuel and prevent fuel system gumming.

## SYNTHETIC CHAINCASE LUBE

Unlike typical gear case oils, SCL's unique viscosity range allows instant flow and film protection in extreme cold or high heat environments.

## ANTI-FREEZE

Polaris® Extended Life Anti-Freeze contains organic acid technologies to prevent corrosion on metal components, eliminate scaling, and maximize cooling system performance.

## DOT 4 BRAKE FLUID

Polaris® DOT 4 Brake Fluid is designed for use in Polaris® hydraulic brakes. Superior high-temp characteristics plus anti corrosion additives extend the life of brake system components.

## OIL

Polaris Blue and VES 2-cycle oils are tested to perform, and are the only oils developed specifically for your Polaris snowmobile engine. Exclusive anti-wear additives protect engine parts with extra rust and corrosion protection.

## ALL-SEASON GREASE

Polaris All-Season Grease is designed to maintain consistency across a wide range of temperatures. Engineered to protect front and rear suspension components, steering bushings, and driveline bearings.

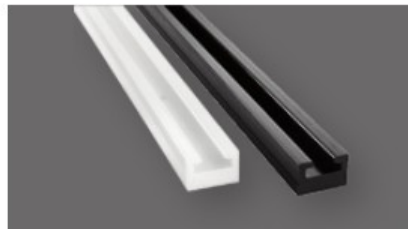
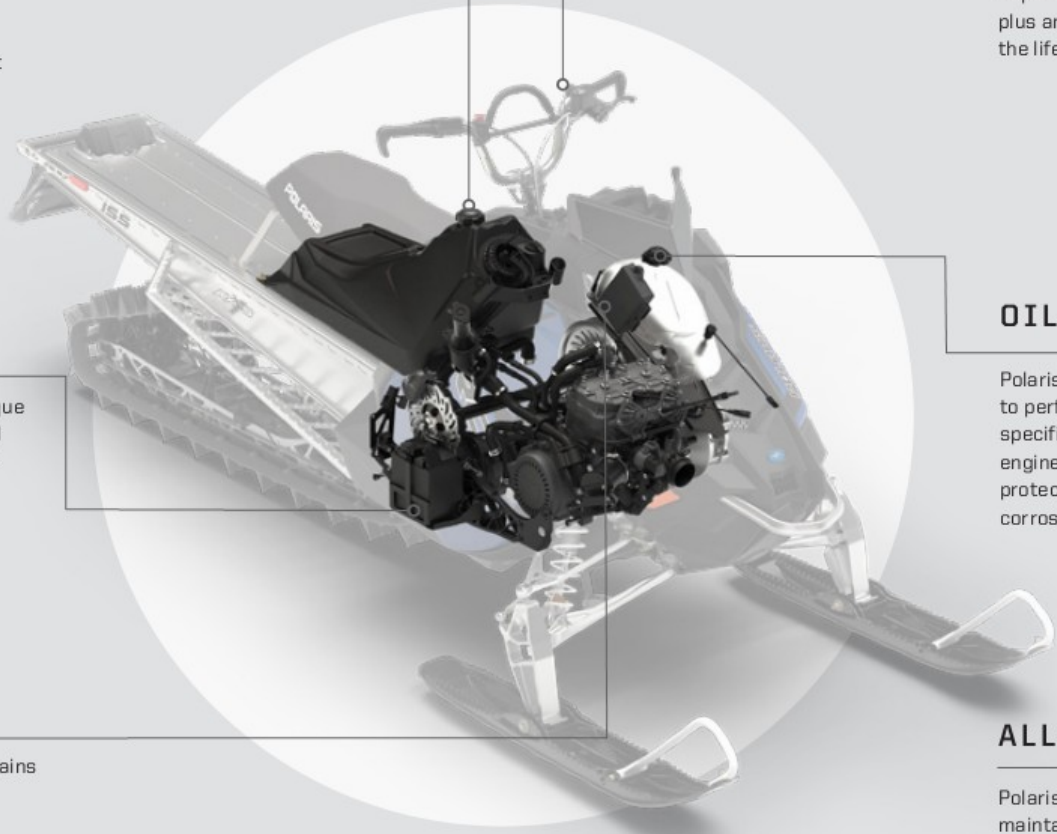

### SLIDERS

Extended life, High impact resistant. Cut to desired length

- » 5521632
  - » 5521633-070
  - » 5521633-309
  - » 5522144-070
- Contact your local dealer for fitment to your unit.



### SPARK PLUGS

Engineered for your Polaris® sled

- » 3070163 NGK BR9ES
  - » 3022082 NGK BPR9ES
  - » 3070190 Champion RN57YCC
- Contact your local dealer for fitment to your unit.



### POLARIS® 838MM TELESCOPIC MAGNET

- » 2830435 | BLACK



### BATTERIES

Polaris Engineered™ tested and approved

- » E04599 | EXIDE. IQ 06-13 (4010774)
- » E04990 | EXIDE. WTIQ 10-16 (4011496)
- » E04999 | EXIDE. RUSH,PRO-Ride 10-16, AXYS | (4013045)



### EXIDE BATTERY CHARGER 220V

Battery charger EXIDE, for LEAD/AGM 12V Batteries 4Ah to 150Ah.

- » E261910 | EXIDE Battery charger 12V-4A, Fits batteries up to 85Ah
- » E261920 | EXIDE Battery charger 12V-7A, Fits batteries up to 150Ah

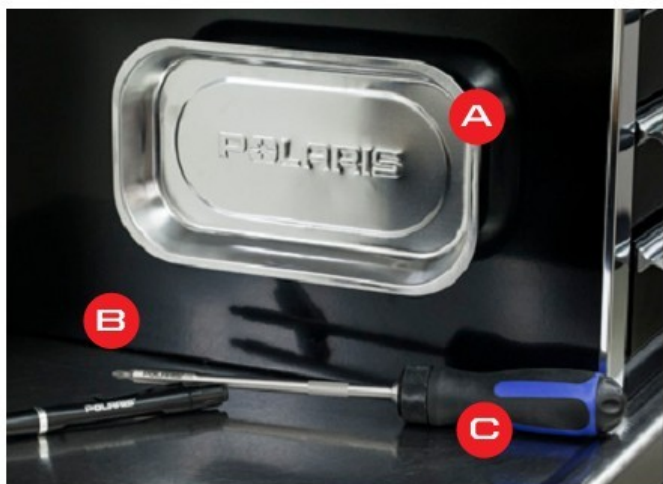

### A POLARIS® MAGNETIC PARTS TRAY

- » 2830432 | Silver

### B POLARIS® LED POCKET FLASHLIGHT

- » 2830436 | Black

### C POLARIS® 305MM HI-TORQUE RATCHETING DRIVER

- » 2830434 | Black / Blue



### POLARIS® HEAVY DUTY SCRUBBER WIPES-90CT

- » 2830441

### POLARIS® SHOP TOWELS

- » 2830440 | 64 ct
- » 2830402 | 200 ct
- » 2830403 | 200 ct refill





APPAREL



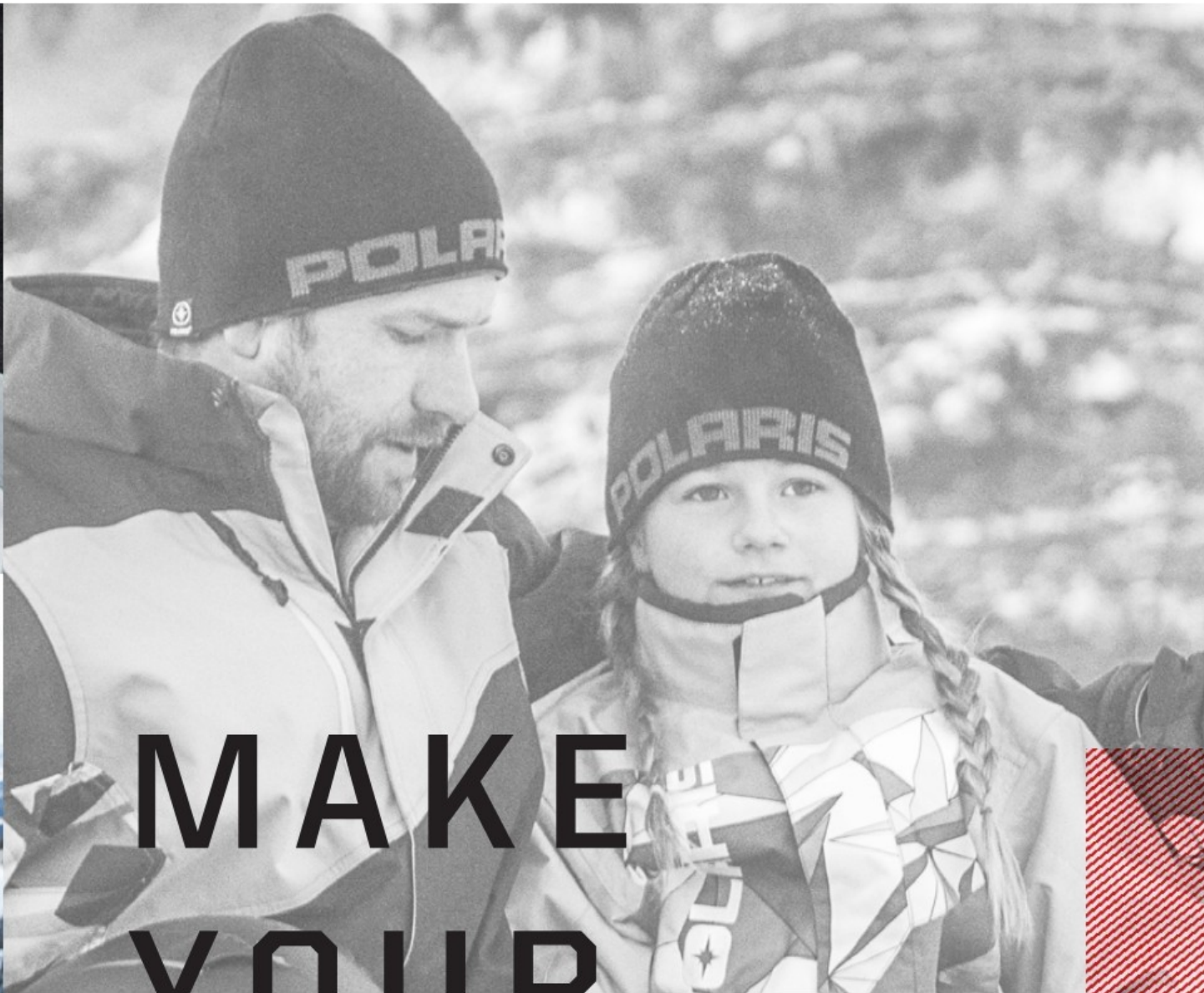

# MAKE YOUR MOMENT



Out here is where we come alive, and come together. It's more than a sport, it's a way of life. Polaris® gear adds comfort, warmth, personal style, and longevity to your riding experience. When you choose Polaris, you become part of a proud community that lives for more miles, more connection, and more escape. Together, we're connected by a Polaris legacy built on moments and memories forged one ride at a time. Together, we are **BORN FOR MORE.**

# MEN'S RIDING GEAR



★ TOP SELLER

TWO-WAY ZIPS FOR VENTING UNDER THE ARMS WITH MESH LINER

ACTION BACK GIVES A LARGE RANGE OF MOTION

BLACK/RED  
 Sizes: S-3XL  
 2867702



## PRO JACKET



ADVANCED, UNINSULATED GORE-TEX® JACKET FOR OUR MOST ACTIVE RIDERS

### SHELL

- Durable 600D polyester outer fabric resists snagging and pilling
- Gore-Tex® membrane is 100% waterproof, windproof, and breathable—guaranteed to keep you dry\*

- Superior DWR prevents precipitation from saturating the jacket's exterior

### FEATURES

- Articulated elbows and action back deliver excellent mobility and reduced rider fatigue
- Storm flap, wrist and waist gaiters, and two-way adjustable pit venting
- 3M® Scotchlite® Reflective Material for nighttime visibility

WARMTH

BREATHABILITY

VERSATILITY

LAYER: OUTER





Crossover

**BLUE**  
 Sizes: S-3XL  
 2869912

# THROTTLE JACKET

**3-IN-1 DESIGN FOR MAXIMUM ADAPTABILITY IN ALL CONDITIONS**

**SHELL**

- Durable 600D polyester outer fabric resists snagging and pilling
- Superior DWR prevents precipitation from saturating the jacket's exterior

**LINING**

- Removable liner with zonal 3M® Thinsulate® Insulation—180 grams in main body, 100 grams in sleeves

**FEATURES**

- Articulated elbows and action back deliver excellent mobility and reduced rider fatigue
- Two-way adjustable pit and back venting with mesh insert, plus wrist and waist gaiters to keep snow and cold out
- 3M® Scotchlite® Reflective Material for nighttime visibility

**WARMTH**



**BREATHABILITY**



**VERSATILITY**



LAYER:  
**3-IN-1**



**AMERICANA**  
 Sizes: S-3XL, MT-2XLT  
 2869911

**REMOVABLE 3M® THINSULATE® LINER** can be worn independently for complete versatility

**3-IN-1 LAYERING SYSTEM**



 **TRAIL**

# RIPPER JACKET

**DWR**

**3M Thinsulate**  
INSULATION

**3M Scotchlite**  
Reflective Material

**YKK**  
ZIPPERS

**RUGGED DESIGN DELIVERS WARMTH AND STYLE**

**SHELL**

- Durable 600D polyester outer fabric resists snagging and pilling
- Superior DWR prevents precipitation from saturating the jacket's exterior

**LINING**

- Built-in zonal 3M<sup>®</sup> Thinsulate<sup>®</sup> Insulation—180 grams in body and 100 grams in arms

**FEATURES**

- Two-way adjustable pit venting with mesh insert
- Storm flap and wrist/waist gaiters keep out snow and cold
- 3M<sup>®</sup> Scotchlite<sup>®</sup> Reflective Material for nighttime visibility

**WARMTH**



**BREATHABILITY**



**VERSATILITY**

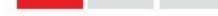

LAYER:  
OUTER



**NEW**



**BLUE**  
Sizes: XS-3XL  
2869908



Superior Durable Water Repellency (DWR) prevents precipitation from saturating the jacket's exterior.



# DRIFTER JACKET



AFFORDABLE COLD WEATHER PERFORMANCE AND STYLE

### SHELL

- Durable 300D polyester outer fabric resists snagging and pilling
- Superior DWR prevents precipitation from saturating the jacket's exterior

### LINING

- Built-in, zonal 3M® Thinsulate® Insulation—180 grams for excellent warmth

### FEATURES

- Two hand pockets and MP3 port
- Wrist and waist gaiters seal out snow and cold to keep you warm
- 3M® Scotchlite® Reflective Material for nighttime visibility

### WARMTH



### BREATHABILITY

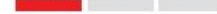

### VERSATILITY

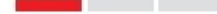

LAYER:  
OUTER



**NEW**



**BLUE/ORANGE**

Sizes: S-3XL  
2869913



**BLUE**

Sizes: S-3XL  
2868533



# MEN'S MONOSUIT



ONE-PIECE DELIVERS FULL RANGE OF MOTION AND KEEPS THE SNOW OUT

## SHELL

- Durable 600D polyester outer fabric resists snagging and pilling
- Superior DWR prevents precipitation from saturating the jacket's exterior

## FEATURES

- One-piece construction ensures powder stays on the outside
- Provides room for a mid-layer for added warmth against the cold
- Features venting in several locations for dumping heat as needed
- Adjustable waist and cuffs, leg and wrist gaiters, and integrated suspenders

## WARMTH

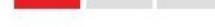

## BREATHABILITY



## VERSATILITY

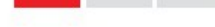

LAYER:  
OUTER



## ACTION BACK

Hidden stretch panels located near outer shoulder allow for ample movement during active riding.



## INTEGRATED SUSPENDERS

The waist fits snugly to the body, thanks to adjustable waist cuffs.



## FULL-LEG YKK® ZIPPERS

Full-leg YKK® zipper construction allows for easy on and off. Also, it helps with venting when off the sled.



UNINSULATED



## BLUE/LIME

Sizes: S-3XL  
2868525

## BLACK/RED

Sizes: S-3XL  
2868524



BLACK

Sizes: S-3XL, MT-2XLT  
2867708

★ TOP SELLER

ARTICULATED KNEES  
WITH REMOVABLE  
EVA FOAM KNEE PADS

ANKLE GAITERS  
KEEP SNOW AND  
WIND OUT

 MOUNTAIN

UNINSULATED

## PRO BIB



DWR

3M Scotchlite®  
Reflective Material

YKK®  
ZIPPERS

TOP-OF-THE-LINE GORE-TEX® BIB FOR EXTREME PERFORMANCE AND COMFORT

### SHELL

- Durable 600D polyester outer fabric resists snagging and pilling
- Gore-Tex® membrane is waterproof, windproof, and breathable - guaranteed to keep you dry®
- Superior DWR prevents precipitation from saturating the bib's exterior

### FEATURES

- Stretch side panels and adjustable shoulder straps guarantee a comfortable fit
- 3M® Scotchlite® Reflective Material for nighttime safety
- Long-lasting YKK® zippers, including full-length zippers on legs

### WARMTH



### BREATHABILITY



### VERSATILITY





**BLACK**  
 Sizes: S-3XL, MT-2XLT  
 2867727



**BLUE/ORANGE**  
 Sizes: S-3XL  
 2869922

**BLUE**  
 Sizes: S-3XL  
 2868536



TRAIL

INSULATED



TRAIL

INSULATED

## RIPPER BIB



## DRIFTER PANT



### COMPLETE VERSATILITY WITH ZIP-OFF DESIGN THAT CONVERTS BIB TO PANT

#### SHELL

- Durable 600D polyester outer fabric resists snagging and pilling
- Superior DWR prevents precipitation from saturating the bib's exterior

#### LINING

- Zonal 3M® Thinsulate® Insulation—180 grams in the front legs and 100 grams in the seat

#### FEATURES

- Zip-off bib design allows them to be worn as pants or bibs
- Rugged, two-way YKK® zippers run full-length for easy-on and easy-off performance
- Stretch side panels for comfort and two zipper hand pockets
- Lower ankle gaiters keep snow out and a retention strap keeps gaiters from riding up
- 3M® Scotchlite® Reflective Material for nighttime visibility

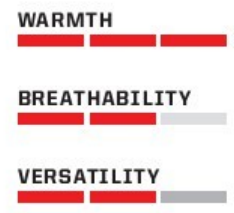

### AFFORDABLE COLD WEATHER PERFORMANCE

#### SHELL

- Durable 300D polyester outer fabric resists snagging and pilling
- Superior DWR prevents precipitation from saturating the pants' exterior

#### LINING

- Zonal 3M® Thinsulate® Insulation—180 grams in the front legs and 100 grams in the seat

#### FEATURES

- Integrated leg gaiters seal out cold and snow
- Belt loops come standard

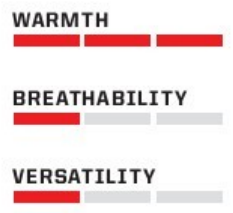



**BLUE/ORANGE**  
 Sizes: S-3XL | 2869919

**NEW**

**BLACK/ORANGE**  
 S-3XL  
 2868514

**BLUE/LIME**  
 S-3XL  
 2868515

## SOFTSHELL JACKET

**CASUAL JACKET ARMED WITH RUGGED AND WARM FEATURES FOR EVERYDAY WEAR**

- Superior DWR prevents precipitation from saturating the jacket's exterior
- Lined with 280 grams of soft fleece for warmth
- Removable hood, underarm venting, three external pockets, and one internal chest pocket

**WARMTH**

**BREATHABILITY**

**VERSATILITY**

LAYER:  
**OUTER**



**GRAY** **NEW**  
 S-3XL | 2869925

### TRAIL MID-LAYER

**LAYER FOR VERSATILITY AND WARMTH WITH THIS BREATHABLE FLEECE MID-LAYER**

- Extra layer of warmth for when you need it
- 280 grams of breathable fleece and a wear-resistant polyester face
- Designed to fit under outer shell when riding
- Extra layer across chest to block wind without restricting movement

**WARMTH**

**BREATHABILITY**

**VERSATILITY**

LAYER:  
**MID**



**BLACK/GRAY**  
 Sizes: S-3XL | 2868512

**GRAY/LIME**

Sizes: S-3XL | 2868513

### MID-LAYER

**LAYER FOR VERSATILITY AND WARMTH WITH THIS BREATHABLE FLEECE MID-LAYER**

- Extra layer of warmth which you can add or subtract depending upon activity and temperature
- 280 grams of breathable fleece and a wear-resistant polyester face
- Designed to fit under outer shell when riding

**WARMTH**

**BREATHABILITY**

**VERSATILITY**

LAYER:  
**MID**







# WOMEN'S RIDING GEAR



 CROSSOVER

**NEW**



**FUSCHIA**  
 Sizes: S-3XL  
 2869917

**DWR**

**3M Thinsulate**  
 INSULATION

**3M Scotchlite**  
 Reflective Material

**YKK**  
 ZIPPERS

## THROTTLE JACKET

VERSATILE JACKET WITH 3-IN-1 DESIGN FOR WARMTH AND COMFORT

### SHELL

- Durable 300D polyester outer fabric resists snagging and pilling
- Superior DWR prevents precipitation from saturating the jacket's exterior

### LINING

- Removable liner with zonal 3M® Thinsulate® Insulation—180 grams in main body, 100 grams in sleeves

### FEATURES

- Two-way adjustable pit venting with mesh inserts
- Two external and two internal pockets in shell
- 3M® Scotchlite® Reflective Material for nighttime visibility

### WARMTH



### BREATHABILITY



### VERSATILITY



LAYER:  
3-IN-1



**BLUE/ORANGE**  
 S-3XL | 2868518

**BLACK**  
 S-3XL | 2869920

**NEW**

## SOFTSHELL JACKET

GREAT JACKET THAT CAN BE WORN FOR RIDING AND EVERYDAY WEAR

- Casual jacket armed with rugged and warm features for everyday wear
- Superior DWR prevents precipitation from saturating the jacket's exterior
- Lined with 280 grams of soft fleece for warmth
- Removable hood and underarm venting, three external pockets, and one internal chest pocket

### WARMTH



### BREATHABILITY



### VERSATILITY



LAYER:  
OUTER



# DIVA JACKET

DELIVERS WARMTH, COMFORT, AND STYLE ON AND OFF THE SLED

## SHELL

- Durable 300D polyester outer fabric resists snagging and pilling
- Superior DWR prevents precipitation from saturating the jacket's exterior

## LINING

- Built-in, zonal 3M<sup>®</sup> Thinsulate<sup>®</sup>—180 grams in the body and 100 grams in the sleeves

DWR

3M  
**Thinsulate**  
INSULATION

3M Scotchlite<sup>™</sup>  
Reflective Material

YKK<sup>®</sup>  
ZIPPERS

## FEATURES

- Two-way adjustable pit venting with mesh inserts
- Storm flap and wrist/waist gaiters to keep snow and cold out
- 3M<sup>®</sup> Scotchlite<sup>™</sup> Reflective Material for nighttime visibility

WARMTH



BREATHABILITY



VERSATILITY

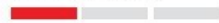

LAYER:  
OUTER



NEW



BLUE

Sizes: S-3XL  
2869915



MARINA BLUE  
S-3XL | 2868598



BLACK/BLUE  
S-3XL | 2868517

## TECH QUARTER-ZIP

EXCELLENT UNDERLAYER PERFORMANCE IN AN EXCEPTIONALLY SOFT AND COMFORTABLE FABRIC

- High-performance garment is ideal as a mid-layer for riding or as a standalone layer
- Four-way stretch material is breathable and moisture-wicking to keep you warm and dry
- Cut and sewn for a contoured fit

WARMTH



BREATHABILITY



VERSATILITY



LAYER:  
MID



## MID-LAYER

LAYER FOR VERSATILITY AND WARMTH WITH THIS BREATHABLE FLEECE MID-LAYER

- Extra layer of warmth for when you need it
- 280 grams of breathable fleece and wear-resistant polyester face
- Designed to fit under outer shell when riding
- Limited seams and inner spandex lining enhance fit without limiting range or adding unwanted bulk

WARMTH



BREATHABILITY



VERSATILITY



LAYER:  
MID



# FIND YOUR PERFECT HELMET

No matter your riding style or personal preference, Polaris® has the perfect helmet choice for you.

## SAFETY RATINGS EXPLAINED

**DOT:** Certification from the United States Department of Transportation

**ECE:** Standards set by the Economic Commission for Europe; similar to the DOT standards



# TENACITY HELMET

ALL THE STYLE AND PROTECTION IN OUR MOST AFFORDABLE HELMET

**SHELL**

- Injection-molded plastic

**WEIGHT**

- 1450 grams

**FEATURES**

- All the style and all the protection in our most affordable helmet
- Stay cool when pushing the limits with oversized mouth intake and top vents with six rear exits
- Stay warm on cold days with optional breath deflect or insert (sold separately)
- Removable, machine-washable liner keeps things fresh ride after ride
- DOT- and ECE2205-certified



**BLACK/GRAY**  
 Sizes: XS-2XL  
 2868620



**BLACK MATTE**  
 Sizes: XS-2XL  
 2868619



**LIME GLOSS**  
 Sizes: XS-2XL  
 2868621



**BLUE GLOSS**  
 Sizes: XS-2XL  
 2868622



**RED GLOSS**  
 Sizes: XS-2XL  
 2868623



**PINK GLOSS**  
 Sizes: XS-2XL  
 2868624

## BALACLAVA

### MOUNTAIN BALACLAVA

- Anti-fog neoprene nose guard

One-Size  
 2867745



## GET THE PERFECT FIT

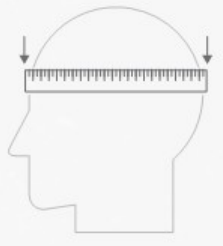

**MEASURE**

Measure the circumference here for correct size. Make sure the inner lining fits snugly around your head without causing pain.



**MOVEMENT**

Move the helmet side to side. Your scalp should move with it.



**CHINSTRAP**

Check with your finger. If properly fit, your finger shouldn't fit between your chin and the strap.

## SIZING GUIDE

SIZE	XS	S	M	L	XL	2XL	3XL	4XL	5XL
SIZE CODE	00	02	03	06	09	12	14	15	16 F
HAT SIZE	6 3/4	6 7/8-7	7 1/8-7 1/4	7-7 1/2	7 5/8-7 3/4	7 7/8-8	8	8 3/4	8 1/2
CIRCUMFERENCE	20 7/8"-21 1/4" (53-54 cm)	21 5/8"-22" (55-56 cm)	22 3/8"-22 3/4" (57-58 cm)	23 1/8"-23 5/8" (59-60 cm)	24"-24 3/8" (61-62 cm)	24 3/4"-25 1/8" (63-64 cm)	25 1/4"-26" (65 cm)	26 3/8"-26 3/4" (66 cm)	27 1/8"-27 1/2" (69-79 cm)

# 509<sup>®</sup> ALTITUDE CARBON HELMET

DURABLE, ULTRA LIGHTWEIGHT, CARBON FIBER

## SHELL

- Full carbon fiber shell

## WEIGHT

- 1100 grams

## FEATURES

- Fidlock<sup>®</sup> magnetic chin strap technology
- Revolutionary neck brace-ready shell profile
- Removeable breath box included
- Universal camera mount included
- Eight intake /exhaust vent ports
- Fully convertible between winter and summer use
- Three outer shell molds across eight sizes for excellent fit
- DOT- and ECE2205-certified



## 509 FOR POLARIS<sup>®</sup>

509<sup>®</sup> delivers the best in modern helmet and goggle integration, with every helmet and goggle designed to fit and seal the elements out together perfectly.

### CARBON MATTE

Sizes: S-4XL  
2867814

### CARBON GLOSS

Sizes: S-4XL  
2867815

# 509<sup>®</sup> ALTITUDE HELMET

STYLISH, LIGHTWEIGHT HELMET WITH 509<sup>®</sup> FIT AND FINISH

## SHELL

- Thermoplastic poly alloy outer shell

## WEIGHT

- 1260 grams

## FEATURES

- Revolutionary neck brace-ready shell profile
- Specially designed expanded polyurethane chin insert
- Eight intake/exhaust vents
- Universal camera mount included
- Removeable breath box included
- Three outer shell molds across eight sizes for excellent fit
- DOT- and ECE 2205-certified



### BLUE

Sizes: S-4XL  
2867820

### ORANGE

Sizes: S-4XL  
2867818

### LIME

Sizes: S-4XL  
2868539

### RED

Sizes: S-4XL  
2867819

### GRAY

Sizes: S-4XL  
2867817

# GOGGLES



**BLACK**  
2868528

## REVOLVER 509<sup>®</sup> SNOW GOGGLE

### THE NEXT EVOLUTION IN SNOWMOBILE GOGGLE TECHNOLOGY

- Innovative pivot lens lock technology allows lens to pivot up and away from frame
- Quickly release moisture and prevent fogging when stopped
- Dual-frame technology and triple foam face for comfort and a perfect seal
- Oversized spherical lens for side field of vision; maximum anti-fog and scratch resistance
- Outrigger support for strap for perfect "inside the helmet" fit for today's moto-style helmets

### REPLACEMENT LENSES



Clear	2868543	Polarized Smoke	2868546
Yellow	2868544		
Chrome	2868545		

## SINISTER X5 509<sup>®</sup> SNOW GOGGLE

### FEATURING EXCELLENT VISIBILITY, ANTI-FOG PERFORMANCE, AND DURABILITY

- Incredible style and premium performance for any rider
- The Outrigger mounting strap allows the goggles to seal tight to your face
- Unique Phantom frame technology eliminates goggle frame intrusion into field of view
- Durable polycarbonate lens is both scratch- and fog-resistant
- Oversized foam seals gaps between helmet and goggle frame for maximum warmth
- Choose from a wide range of replacement lenses in multiple colors and finishes



**ORANGE**  
2868529



**BLACK**  
2868531



**LIME**  
2868530

### REPLACEMENT LENSES

Clear	2865123	Rose	2865126
Yellow	2865124		
Chrome	2865125	Polarized Yellow	2865127
		Polarized Smoke	2865128



**509 FOR POLARIS®**



**NEW** LIME  
2869538



**NEW** RED  
2869537



BLACK  
2868532

## KINGPIN 509® SNOW GOGGLE

### PREMIUM MATERIALS IN AN AFFORDABLE PACKAGE

- Oversized lens delivers wide field of vision with scratch-resistant and anti-fog coating
- Contoured frame and triple-layer foam seals out cold and snow
- Removable nose piece delivers versatile cold weather protection
- Quick-change lens technology for fast lens tint swaps

### REPLACEMENT LENSES



Polarized Smoke	2868550
Chrome/Yellow	2868549
Clear	2868547
Yellow	2868548

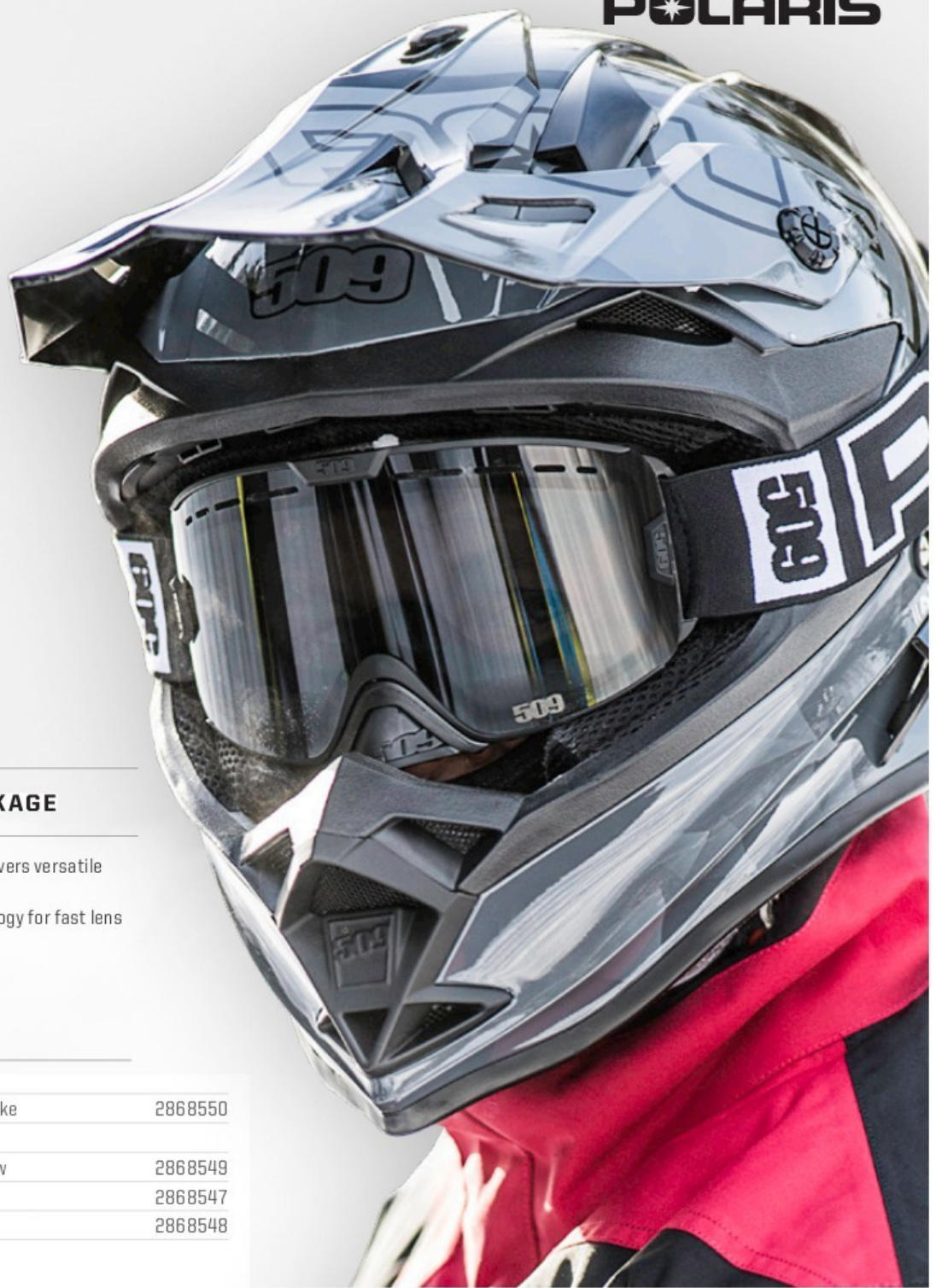

### OWN THE PERFECT LENS FOR EVERY LIGHT CONDITION

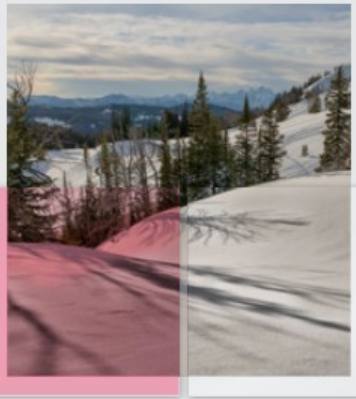

#### ROSE & CLEAR

- Delivers superior low-light visibility
- Increases contrast in cloudy conditions



#### YELLOW & GOLD

- Enhances flat-light terrain definition
- Delivers superior depth perception

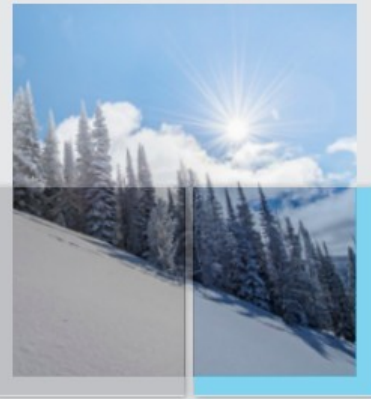

#### SMOKE & BLUE

- Cuts down brightness without distorting color
- Reduces eyestrain

### CARRY MULTIPLE LENSES SO YOU CAN EASILY ADJUST FOR LIGHTING

#### LENS COATINGS:



#### MIRRORED

- Reduces glare by reflecting light
- Maintains visibility of LCD readouts
- Paired with lighter tints to offset darkening



#### POLARIZED

- Substantially reduces glare and blinding
- Blocks horizontal light waves
- Decreases eyestrain

# UNINSULATED GLOVES



Sizes: S-3XL  
2867744

STANDARD



Sizes: S-3XL  
2868522

MEDIUM

## MOUNTAIN LEVEL 1

### POPULAR VALUE-PACKED GLOVE FOR ACTIVE OFF-TRAIL RIDING

- Synthetic leather palm with silicone print for a sure grip
- Adjustable wrist strap seals out snow
- Dry-zone anti-slip insert
- Built-in goggle squeegee on backside of glove to keep vision clear

#### INSULATION



#### PADDING

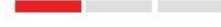

#### GRIP

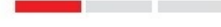

## MOUNTAIN LEVEL 2

### A PERFECT BLEND OF THIN, LIGHTWEIGHT MATERIAL AND WARMTH

- Polyurethane palm for excellent grip while isolating hands from vibration
- Moisture-wicking liner keeps hands dry; 100 grams of insulation for warmth
- Backhand Armor provides protection from branches and debris
- Features adjustable wrist enclosures and integrated goggle squeegee

#### INSULATION



#### PADDING



#### GRIP



# INSULATED GLOVES



Sizes: S-3XL  
2867743

STANDARD



Sizes: S-3XL  
2868520

MEDIUM

## TRAIL LEVEL 1

### POPULAR VALUE-PACKED GLOVE FOR TRAIL RIDING

- Synthetic leather palm with silicone print for a sure grip
- Fully insulated with 100 grams on the back of the hand and 60 grams on the palm
- Night riding safety with built-in 3M® Scotchlite® Reflective Material
- Adjustable wrist strap and gauntlet shock cord closure
- Dry-zone anti-slip insert
- Built-in goggle squeegee on backside of glove to keep vision clear

#### INSULATION



#### PADDING



#### GRIP



## TRAIL LEVEL 2

### VERSATILE PERFORMANCE WITH A PERFECT BLEND OF MATERIAL

- Over-jacket gauntlet seals out cold and snow, ideal for trail riding
- Polyurethane palm for optimum grip while isolating hands from vibration
- Moisture-wicking liner keeps hands dry; 100 grams of insulation for warmth
- Backhand Armor provides protection from frost and ice chunks
- Features adjustable wrist enclosures and integrated goggle squeegee

#### INSULATION



#### PADDING



#### GRIP





Sizes: S-3XL  
2868523

EXTREME

### MOUNTAIN LEVEL 3

#### OUR WARMEST SHORT-CUFF RIDING GLOVE COMBINED WITH MOBILITY

- Leather palm combines superior grip and long-lasting wear qualities
- Moisture-wicking liner keeps hands dry; 160 grams of insulation for maximum warmth
- Backhand Armor provides protection from branches and debris
- Features adjustable wrist enclosures and integrated goggle squeegee



Sizes: S-2XL  
2867723

### SOFTSHELL RACE GLOVE

#### DESIGNED FOR HIGHLY ACTIVE RIDING AND RACING

- Inspired by professional Polaris® race team members
- Pre-curved design for maximum comfort and handlebar control
- Palm material provides ideal grip without unwanted vibration
- Foam padded inserts absorb impacts and vibration
- Neoprene cuff features adjustable closure for a secure, comfortable fit
- Reinforced seams and material in key areas for maximum durability

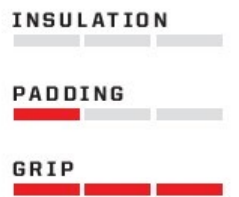

Sizes: S-3XL  
2868521

EXTREME

### TRAIL LEVEL 3

#### OUR WARMEST LONG-CUFF TRAIL RIDING GLOVE FOR EXCELLENT WARMTH

- Long wrist, over-the-jacket gauntlet seals out snow and cold with pull-tight shock cords
- Leather palm combines superior grip and long-lasting wear qualities
- Moisture-wicking liner keeps hands dry; 200 grams of insulation for maximum warmth
- Backhand Armor provides protection from frost and ice chunks
- Features adjustable wrist enclosures and integrated goggle squeegee



Sizes: S-2XL  
2869526

### WOMEN'S TRAIL 2 GLOVE

#### EXCELLENT GLOVE OFFERING ALL-AROUND VALUE AND PERFORMANCE

- 150 grams poly fill insulation
- Nylon Oxford shell & Amara® palm
- Gauntlet-style cuff with elastic pull & toggle
- Amara® pull patch makes it easy to pull gloves on



MAKE SURE YOUR HANDS STAY WARM WHEN THE NIGHTTIME COLD SETS IN. PACKING MULTIPLE GLOVES MEANS MAXIMUM COMFORT.

# BOOTS



HIGHLY VISIBLE 3M<sup>®</sup> SCOTCHLITE<sup>™</sup> REFLECTIVE MATERIAL



ICE LOCK<sup>®</sup> SOLE TECHNOLOGY



600 GRAMS OF 3M<sup>®</sup> THINSULATE<sup>®</sup> INSULATION

## BOA SYSTEM VS. LACES

Push to engage. Turn to tighten. Pull for quick release. The BOA lacing system gives a perfect fit with the turn of a knob—even with gloves on.



## SWITCHBACK BOOT

### PERFORMANCE, WARMTH, AND COMFORT

- Dry-Lex<sup>®</sup> membrane keeps feet dry, 3M<sup>®</sup> Thinsulate<sup>®</sup> delivers unmatched warmth for all-day comfort
- Constructed from durable leather for long-lasting wear season after season
- Lightweight design is extremely comfortable and perfect for active riders
- Ice Lock<sup>®</sup> sole with microscopic glass shards for sure grip on slippery surfaces

INSULATION



TRACTION



WEIGHT



### BOA SYSTEM

Sizes: 38-47  
2868527

# BEANIES

TECH MESH



**MEN'S TECH MESH BEANIE**

Black | 2868650



**WOMEN'S TECH MESH BEANIE**

Black | 2868646  
Gray | 2868647



A beanie can be the perfect item to put on when you take your helmet off. It is lightweight, warm, and means no one will see your mussed hair. Priorities. Featuring CarbonASR™ heat-regulating technology. Carbon fibers absorb your body's warmth, store it, and release it when needed, making these Tech Mesh Beanies the most advanced on the market.



## MEN'S



**NORTHERN STAR BEANIE**

Black | 2867751  
Gray | 2867752

## WOMEN'S



**WOMEN'S CABLE BEANIE**

Berry | 2868643



**SHATTERED CUFF CAP**

Gray | 2868651  
Lime | 2868652

# AFTER THE RIDE



**NEW**

## RETRO LOGO HOODIE

Black | S-3XL | 2869549  
Charcoal/Lime | S-3XL | 2868578



**NEW**



## ESTA TEE

Charcoal | S-3XL | 2869552  
Navy | S-3XL | 2869562  
Black | S-3XL | 2868570



**NEW**

## COLOR BLOCK HOODIE

Navy | S-3XL | 2869532



**NEW**

## ESTA CREW SWEATSHIRT

Charcoal Heather | S-3XL | 2869550



**NEW**

RACE

## RACE TECH FULL-ZIP

Black | S-3XL | 2869533



## RETRO TEE LONG SLEEVE

Gray | S-3XL | 2868571



**HEX TEE**

Ash Heather | S-3XL | 2869551  
Navy Heather | S-3XL | 2868568  
Black | S-3XL | 2867770



**ROSEAU TEE**

Charcoal Heather | S-3XL | 2869560  
Navy Heather | S-3XL | 2867778



**RACE HOODIE**

Gray | S-3XL | 2868558



**EXHAUST TEE**

Navy Heather | S-3XL | 2869567  
Ash Heather | S-3XL | 2869568



# CAPS

**NEW**



**NEW**



### RETRO CAP

Gray/Red | One-Size | 2869542  
Navy/Lime | One-Size | 2869543



### CLASSIC RACING CAP

Navy | One-Size | 2867760  
Black | One-Size | 2867761



### HEX CAP

One-Size | 2867766

**NEW**



**NEW**



### RETRO TRUCKER CAP

Navy | One-Size | 2869539  
Red | One-Size | 2869540



**NEW**



### CORE CAP

Navy | One-Size | 2869544  
Black | One-Size | 2867762



# WOMEN'S



### RETRO CAP

Blue | One-Size | 2869545  
Light Blue | One-Size | 2869547



**RACE HOODIE**  
Gray | S-3XL | 2868600

RACE



**HEX TEE**  
Navy | S-2XL | 2869565

CAPS & WOMEN'S SPORTSWEAR

NEW



**RETRO PULLOVER HOODIE**  
Navy | S-3XL | 2869555



RACE

**RACE TECH FULL-ZIP**  
Black | S-3XL | 2869534

NEW



**V-NECK SCRIPT TEE**  
Gray | S-3XL | 2868588  
Black | S-3XL | 2869558

CAPS & WOMEN'S SPORTSWEAR

# YOUTH



## RIPPER JACKET

- Durable 300D polyester outer fabric resists snagging and pilling
- Built-in, zonal 3M® Thinsulate® Insulation—180 grams in body, 100 grams in sleeves and neck
- Two external pockets & internal zip pockets
- Long-lasting YKK® zippers in all closures, main closure features storm flap
- 3M® Scotchlite® Reflective Material for nighttime visibility

Lime Print | S-XL | **2868510**



## RIPPER BIB

- 300D soft durable shell fabric with DWR (Durable Water Repellent)
- 3M® Thinsulate® zonal insulation—180 grams where it's needed most and 100 grams where it's not
- The ultimate youth bib for riding or playing in the snow
- Unique "Grow With Me" double seam design allows bibs to lengthen up to 5 cm as your child grows

Gray | S-XL | **2867741**



## REVERSIBLE BEANIE

- Two beanies in one with this reversible design with right-fit sizing for kids

Blue | S-XL | **2868639**  
 Lime | S-XL | **2868640**  
 Pink | S-XL | **2868641**  
 Marina Blue | S-XL | **2868642**



## NEW GLOVE

- Mapped insulation with 200 grams on back of hand and 100 grams on palm
- Goggle squeegee on index and nose wipe on the back of thumb
- Gauntlet shock cord closure to keep snow and cold out

Black | S-XL | **2869529**



## SCAPE TEE

Blue | S-XL | **2867797**  
 Red | S-XL | **2869570**



## SCRIPT TEE

Raspberry | S-XL | **2869572**



## RACE PULLOVER HOODIE

Gray | S-XL | **2868604**



## HEX TEE

White | S-XL | **2867800**

## SIZING GUIDE

Size:	XS	SM	MD	LG	XL
Chest:	56-58	61-64	66-69	71-74	76-70
Waist:	51-53	56-58	61-64	66-69	71-74
Sleeve:	36-43	46-53	56-58	58-61	61-64
Inseam:	38	46	53	58	64



## OGIO® 9800 RIG ROLLER

- SLED (Structural Load Equalizing Deck) system for increased durability and handling in the harshest of conditions
- Wide-mouth LID opening for easy access to all gear compartments
- Large main compartment with adjustable dividers and padded helmet chamber
- iFOM (integrated foam) construction throughout for added gear protection
- Heavy-duty oversized wheels with extra clearance
- Telescoping pull handle

2867869



### OGIO® BIG MOUTH GEAR BAG

- Extra-large access to main volume
- Ogio® SKID system includes large diameter wheels and axles
- Dimensions: 80 H x 40 W x 46 D

2867870

### OGIO® ALL ELEMENTS BACKPACK

- Completely waterproof roll top construction
- 420D nylon
- Dimensions: 52 (rolled)" H x 27 W x 17 D

2867873

### OGIO® AXIL LAPTOP BACKPACK

- Airport checkpoint-friendly laptop compartment fits most 43 cm laptops
- Multiple organization pockets
- 840D double ripstop face coated
- Dimensions: 44 H x 33 W x 23" D

2867872

### OGIO® SLAYER GEAR BAG

- Separate internal pockets
- Heavy-duty 900D fabric with eco-friendly PVC backing specs
- Dimensions: 80 H x 40 W x 46 D

2867871

CHOICES FOR EVERY RIDER.



**SKAFFA POLARISKORTET REDAN IDAG!**

DELBETALNING UPP TILL

**24 MÅNADER**

PÅ TILLBEHÖR, KLÄDER, RESERVDLAR OCH SERVICE.

Läs mer och ansök på: [polarissverige.com/polariskortet](http://polarissverige.com/polariskortet)

LOCAL DEALER:

POLARIS SCANDINAVIA AB | [WWW.POLARISSVERIGE.COM](http://WWW.POLARISSVERIGE.COM) | [WWW.FACEBOOK.COM/POLARISSWEDEN](http://WWW.FACEBOOK.COM/POLARISSWEDEN)

CONTACT YOUR LOCAL DEALER FOR ADDITIONAL INFORMATION!  
Reservation regarding print-errors, deviation from the written  
content and color-deviation in the depicted material.  
Polaris Scandinavia AB April 2018

**TERRAIN  
DOMINATION**



Art.nr.: ST2019S