

2021



APPAREL & ACCESSORIES

POLARIS

SCANDINAVIAN VERSION

POLARIS

2021

APPAREL & ACCESSORIES



RMK

LIGHTEST. STRONGEST.
MOST FLICKABLE.



SWITCHBACK

SMOOTHEST RIDING.
MOST VERSATILE.



INDY

LEGENDARY PERFORMANCE.
SIMPLY FUN.

KNOW YOUR CHASSIS FOR THE PERFECT FIT

Please consult the chart below to determine which chassis you have and order accordingly.

	PRO-RMK, SKS	RMK KHAOS	RMK EVO	RMK ASSAULT	SWITCHBACK ASSAULT	SWITCHBACK	SWITCHBACK SP	RUSH
MATRYX					MY21			
AXYS	MY16-MY21	MY20-MY21		MY16-MY19	MY17-MY21	MY15-MY21	MY17-MY21	MY15-MY20
PRO-RIDE	MY11-MY15		MY20-MY21	MY11-MY15	MY11-MY16	MY10-MY14		MY10-MY14

WE MADE IT SO YOU CAN

LIVE IT.

APPAREL

Men's Apparel	6
Women's Apparel	20
Youth Apparel	26
Helmets	28
Goggles	32
Gloves	34
Boots + Beanies	36
OGIO® Bags	37

ACCESSORIES

MATRYX	48
Lock & Ride Flex	52
Dash Storage	54
Tunnel Storage	56
INDY/SWITCHBACK Storage	58
TITAN Storage	60
Seating	64
Windshields	66
Bumpers, Skid Plates + Hitches	68
Skis, Shocks + Kits	70
Handlebars + Electronics	72
RIDE COMMAND + P.I.D.D.	74
Covers + Trailering	76
Studs, Strips + Tracks	78

GARAGE

Maintenance	82
Oil	86
Lubricants + Belts	88
Garage + Batteries	90
Education	91



TITAN

UNMATCHED CAPABILITY.
UNCOMPROMISING PERFORMANCE.



VOYAGEUR

LIMITLESS
POSSIBILITIES.

TITAN	600 INDY	600 VOYAGEUR	550 INDY 121/144	550 VOYAGEUR	550 INDY LXT, INDY ADVENTURE	INDY XC 129	INDY EVO	INDY ADVENTURE 137, INDY XC 137	INDY XCR
						MY21		MY21	
MY18-MY21		MY17-MY21				MY19-MY21		MY20-MY21	MY20-MY21
	MY13-MY21	MY14-MY16	MY13-MY21	MY13-MY21	MY13-MY21		MY19-MY21		



MEN'S HATS
pg 18

MEN'S SOFTSHELL JACKET
pg 14

WOMEN'S FORCE JACKET
pg 23

APPAREL

FRESH POWDER. FRESH GEAR.

Create the ultimate riding gear arsenal with the performance, comfort and style of waterproof and breathable TECH54 jackets and bibs along with premium layering. Add the right Polaris 509 helmet and goggles to complement your riding style and finish the day with stylish casual wear.



TECH54

TECHNOLOGY TO

**CONQUER
THE RIDE.**

ELEVATE YOUR RIDE
WITH EXCLUSIVE
TECH54 RIDING GEAR
DESIGNED TO KEEP
YOU WARM AND DRY.

To us, winter is more than just another season. It's when the landscape is frozen by an icy grip and snow transforms terrain into an endless playground. Like you, we savor every minute, which is why our Apparel Center of Excellence developed TECH54—a waterproof, breathable membrane featured in every Polaris jacket, bib and monosuit. This exclusive technology allows perspiration to escape and keeps water out, so no matter how you ride, or where you ride, you stay dry, warm and comfortable.

- 
- Heat and sweat escape
 - Water stays out
 - Tailored for how you ride
 - Stay dry, warm and comfortable





- Choose your TECH54 rating based on the weather conditions and your level of exertion
- Choose **5K/5K** for colder & drier conditions and moderate activity
- Choose **10K/10K** for extremely wet riding conditions and high-activity riding

TECH54 is featured in all Polaris jackets, bibs and monosuits including men's, women's and youth. Look for the TECH54 logo when shopping at your local dealer or online.



DIVE DEEPER INTO TECH54 AT [POLARIS.COM/TECH54](https://www.polaris.com/tech54) 



Any weather, any terrain, any adventure—TECH54 will never let you down.



TECH54

UNINSULATED



GRAY/RED
S-2XL
2860519

NEW
RED/BLUE
S-2XL
2861427



BLACK
S-2XL
2860533

10K/10K

DWR

3M Scotchlite[®]
Reflective Material

YKK[®]
ZIPPERS

REVELSTOKE

JACKET

BIB

ADVANCED UNINSULATED JACKET WITH MAXIMUM BREATHABILITY AND WATERPROOFNESS

ADVANCED UNINSULATED BIB WITH MAXIMUM BREATHABILITY AND WATERPROOFNESS

- Durable 300 denier poly shell is tear- and snag-resistant and treated with superior DWR to shed snow and water from the outer shell
- Features TECH54 bonded internal laminate with 10k/10k properties
- Three external pockets (two hand, one chest)
- Four vents (two front, two back)

- Shock-cord adjustable bottom hem
- 3M[®] Scotchlite[®] Reflective Material for nighttime visibility



- Durable 300 denier poly shell is tear- and snag-resistant and treated with superior DWR to shed snow and water from the outer shell
- Features TECH54 bonded internal laminate with 10k/10k properties
- Storm cuffs with boot-lace retention snaps

- 3M[®] Scotchlite[®] Reflective Material for nighttime visibility
- Two inner-thigh vents
- Two-way front zipper

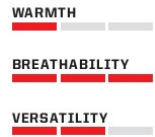

10K/10K

DWR

3M Scotchlite®
Reflective Material

YKK®
ZIPPERS

PRO MONOSUIT

OUR MOST EVOLVED ONE-PIECE WITH MAXIMUM BREATHABILITY, WATERPROOFNESS, INCREASED RANGE OF MOTION WITH CUSTOMIZED FIT AND PLENTY OF POCKETS

- Durable 300 denier poly shell is tear- and snag-resistant and treated with superior DWR to shed snow and water from the outer shell
- Features TECH54 bonded internal laminate with 10k/10k properties
- One-piece construction ensures powder stays on the outside

- 3M® Scotchlite® Reflective Material for nighttime visibility
- Provides room for a mid-layer for added warmth against the cold
- Increased storage including four external pockets (two hand, one chest, one thigh)

WARMTH

BREATHABILITY

VERSATILITY

TECH54 UNINSULATED

IMPROVED MOBILITY

Action back for ease of movement and articulated fit for maximum mobility and comfort.



CUSTOMIZED FIT

Adjustable waist tabs and internal suspenders for a comfortable and customized fit.



SUPERIOR VENTING

Two vents on the side and two vents on the leg help dump heat as needed when riding, and the leg zips can be opened for extra venting when off the sled.



NEW BLACK

S-2XL
2861428

BLACK/LIME

S-2XL
2860522

NAVY

S-2XL
2860523

APPAREL

MEN'S APPAREL

WOMEN'S APPAREL

YOUTH APPAREL

HELMETS

GOGGLES

GLOVES

BOOTS & BEANIES
& GOGGLE BAGS



TECH54

NEW
BLUE/RED

Sizes: S-2XL
2861426



10K/10K DWR

3M Thinsulate
INSULATION

3M Scotchlite
Reflective Material

YKK
ZIPPERS

JACKET

QUICK-CHANGE VERSATILITY WITH PREMIUM SHELL AND REMOVABLE ZONAL INSULATED LINER

- Durable 300 denier poly shell is tear- and snag-resistant and treated with superior DWR to shed snow and water from the outer shell
- Features TECH54 bonded internal laminate with 10k/10k properties
- Removable insulated liner with 150g insulation in body and 100g in arms
- Shock-cord adjustable bottom hem
- Removable/adjustable hood
- 3M® Scotchlite® Reflective Material for nighttime visibility

WARMTH

BREATHABILITY

VERSATILITY

INSULATED

BLACK/LIME

Sizes: S-2XL
2860515



MAXIMUM VERSATILITY



Remove the insulated liner without sacrificing waterproof breathability, while increasing versatility for changing ride conditions.

SWITCHBACK



BIB/PANT

VERSATILE, PREMIUM BIB FEATURES ZONAL INSULATION AND EASY CONVERSION TO PANTS

- Durable 300 denier poly shell is tear- and snag-resistant and treated with superior DWR to shed snow and water from the outer shell
- Features TECH54 bonded internal laminate with 10k/10k properties
- Insulated with 150s insulation in front and 100s in back
- 3M® Scotchlite® Reflective Material for nighttime visibility
- Storm cuffs with boot-lace retention snaps
- Two inner-thigh vents
- Two-way front zipper
- Removable suspenders allow bib to be converted to an adjustable waist pant

WARMTH



BREATHABILITY



VERSATILITY



BLACK
S-2XL
2860532

Superior Durable Water Repellency (DWR) prevents precipitation from saturating the exterior of all outerwear pieces.



APPAREL

MEN'S APPAREL

WOMEN'S APPAREL

YOUTH APPAREL

HELMETS

GOGGLES

GLOVES

BOOTS & BEANIES
& GOGGLE BAGS

3



TECH54



5K/5K

DWR

3M Thinsulate
INSULATION

3M Scotchlite
Reflective Material

YKK
ZIPPERS

INSULATED

JACKET

DURABLE, INSULATED JACKET FOR EXCEPTIONAL WARMTH WITH MINIMAL BULK

- Durable 300 denier poly shell is tear- and snag-resistant and treated with superior DWR to shed snow and water from the outer shell
- Features TECH54 bonded internal laminate with 5k/5k properties
- Insulated with 180g insulation in body and 100g in arms
- Shock-cord adjustable bottom hem
- 3M Scotchlite® Reflective Material for nighttime visibility

WARMTH



BREATHABILITY



VERSATILITY



NEW
BLACK/BLUE

S-2XL
2861425

NORTHSTAR



BIB

DURABLE DESIGN, ZONAL INSULATION FOR EXCEPTIONAL WARMTH WITH MINIMAL BULK

- Durable 300 denier poly shell is tear- and snag-resistant and treated with superior DWR to shed snow and water from the outer shell
- Features TECH54 bonded internal laminate with 5k/5k properties
- Insulated with 180g insulation in upper front of legs and lower back and 100g on upper backside
- 3M® Scotchlite® Reflective Material for nighttime visibility
- Storm cuffs with boot-lace retention snaps
- Two external hand pockets and an adjustable waist
- Two-way front zipper

WARMTH



BREATHABILITY



VERSATILITY

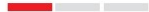

Superior Durable Water Repellency (DWR) prevents precipitation from saturating the exterior of all outerwear pieces.



BLACK
S-2XL
2860531

APPAREL

MEN'S APPAREL

WOMEN'S APPAREL

YOUTH APPAREL

HELMETS

GOGGLES

GLOVES

BOOTS & BEANIES
& GOGGLE BAGS

MEN'S LAYERING

NEW
FORCE JACKET

VERSATILE AND LIGHTWEIGHT,
IDEAL MID-LAYER OR CASUAL WEAR

- 140g 3M™ Thinsulate®
- Two external hand pockets
- One internal media pocket
- Rugged YKK® zippers
- Compactable into travel pocket

WARMTH

BREATHABILITY

VERSATILITY

LAYER:
MID

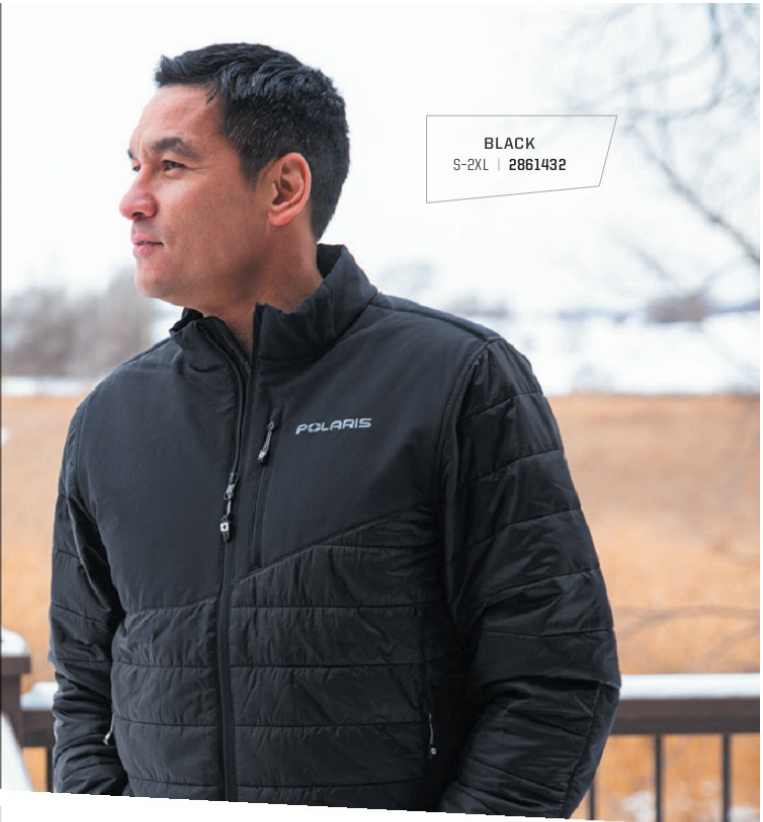

BLACK
S-2XL | 2861432



NEW
NAVY
S-2XL | 2861444



SWITCHBACK MID-LAYER

VERSATILE MID-LAYER WARMTH
OR CASUAL STAND-ALONE STYLE

- Extra layer of warmth that you can add or subtract depending on activity and temperature
- 280g of breathable fleece and a wear-resistant polyester face
- Designed to fit under outer shell when riding

WARMTH

BREATHABILITY

VERSATILITY

LAYER:
MID





NEW
BLUE
 S-2XL | 2861443

NEW
BLACK/RED
 S-2XL | 2861445

APPAREL
 MEN'S APPAREL
 WOMEN'S APPAREL
 YOUTH APPAREL

TECH QUARTER-ZIP

EXCELLENT FOR RIDE LAYERING, COMFORTABLE AND STYLISH STAND-ALONE

- High-performance garment is ideal as a mid-layer riding or as a stand-alone layer
- Four-way stretch material is breathable and moisture-wicking to keep you warm and dry
- Cut and sewn for a contoured fit

WARMTH

BREATHABILITY

VERSATILITY

LAYER: MID



NORTHSTAR MID-LAYER

BREATHABLE FLEECE MID-LAYER IS PERFECT FOR ADDING WARMTH OR AS A STAND-ALONE SHIRT

- Extra layer of warmth for when you need it
- 280s of breathable fleece and a wear-resistant polyester face
- Designed to fit under outer shell when riding
- Wind-block layer on chest for added warmth and wind protection

WARMTH

BREATHABILITY

VERSATILITY

LAYER: MID



HELMETS
 GOGGLES



GRAY | TOP
 S-2XL
 2861453



GRAY | BOTTOM
 S-2XL
 2861454

NEW MIDWEIGHT BASE LAYER

ADD MORE INSULATION WHEN THE WEATHER TAKES A COLDER TURN

- Comfortable stretch fabric to allow for maximum movement
- 92% polyester, 8% spandex
- Soft brushed-fleece liner

WARMTH

BREATHABILITY

VERSATILITY

LAYER: MID



GLOVES
 BOOTS & BEANIES
 BODYPANTS



SOFTSHELL JACKET

LIGHTWEIGHT PERFORMANCE THAT'S SURPRISINGLY WARM AND PERFECT FOR EVERYDAY WEAR

- Casual jacket armed with rugged and warm features for everyday wear
- Superior DWR prevents precipitation from saturating the jacket's exterior
- Lined with 280s of soft fleece for warmth
- Removable hood and underarm venting, three external pockets and one internal chest pocket

WARMTH

BREATHABILITY

VERSATILITY



NEW Black/Blue | S-2XL | 2861436



NEW
CHECKERED LONG SLEEVE

Gray | S-2XL | 2861587



NEW
DASH LONG SLEEVE

Navy | S-2XL | 2861583



NEW
ICON LONG SLEEVE

Black | S-2XL | 2861584



NEW
TECH HOODIE
Gray | S-2XL | 2861493



NEW
COLOR BLOCK HOODIE
Gray | S-2XL | 2861503



NEW
CREW SWEATSHIRT
Green | S-2XL | 2861498



NEW
ICON HOODIE
Green | S-2XL | 2861495



NEW Gray/Red | S-2XL | 2861504
RETRO LOGO HOODIE



NEW
RACING FULL-ZIP HOODIE
Black | S-2XL | 2861499



NEW
STAMP HOODIE
Navy | S-2XL | 2861500

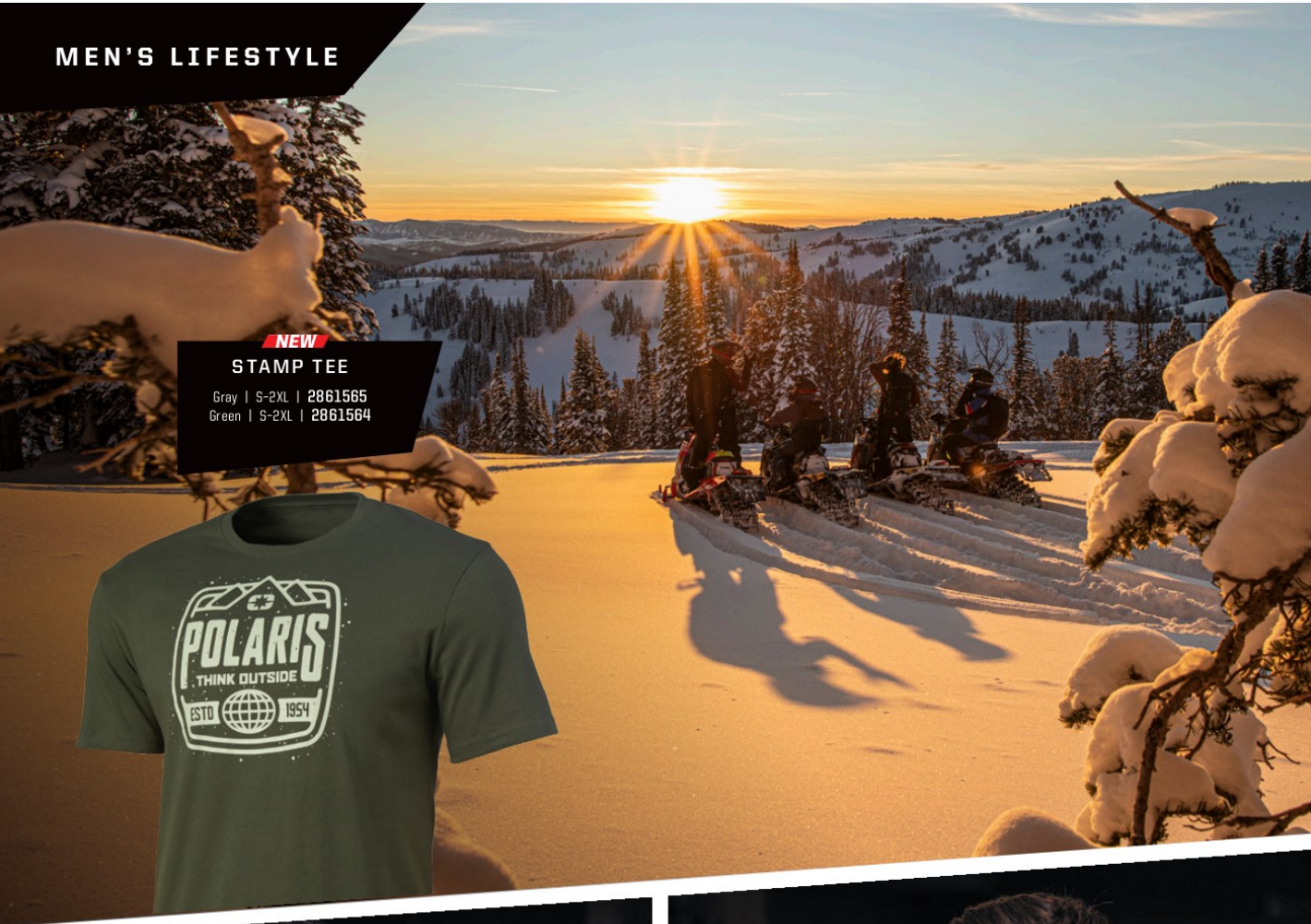

NEW
STAMP TEE
Gray | S-2XL | 2861565
Green | S-2XL | 2861564



NEW
ALL IN TEE
Black | S-2XL | 2861574



NEW Navy | S-2XL | 2861578



BACK-PICTURED IN GRAY



NEW
BACK GRAPHIC TEE

Navy | S-2XL | 2861569

NEW
CORP POLO

Navy | S-2XL | 2861490



NEW
SNOW 4 SCENE TEE

Gray/Red | S-2XL | 2861576



NEW
ICON TEE

Blue | S-2XL | 2861571



NEW
RACING TEE

Black | S-2XL | 2861580



NEW
HERITAGE TEE

Black | S-2XL | 2861579



NEW
THINK OUTSIDE TEE

Black | S-2XL | 2861567



NEW
CORE TEE

Black | S-2XL | 2861572

HATS



NEW CHECKERED HAT

- Blue | One Size | 2861520
- Gray | One Size | 2861521
- Black | One Size | 2861522



NEW ALL IN HAT

- Gray | One Size | 2861534
- Black | One Size | 2861535





NEW TONAL HAT

Navy | One Size | 2861525



CORE CAP

Black | One Size | 2861524



NEW RETRO CAP

Gray | One Size | 2861536



NEW POLARIS RACING HAT

Black | S-M | 2861528
Black | L-XL | 2861529



NEW STEALTH CAMO CAP

Black | One Size | 2861527



NEW ELLIPSE PATCH TRUCKER HAT

Black | One Size | 2861533



WOMEN'S CROSSOVER GEAR

TECH54

INSULATED

NEW
MAROON/GRAY

S-XL
2861431



BLACK
S-XL
2861556



10K/10K

DWR

3M Thinsulate
INSULATION

3M Scotchlite
Reflective Material

YKK
ZIPPERS

SWITCHBACK

JACKET

PREMIUM JACKET WITH REMOVABLE INSULATED LINER FOR ALL-DAY VERSATILITY

- Durable 300 denier poly shell is tear- and snag-resistant and treated with superior DWR to shed snow and water from the outer shell
- Features TECH54 bonded internal laminate with 10k/10k properties
- Removable liner with 150s insulation in body and 100s in arms
- Shock-cord adjustable bottom hem
- Removable/adjustable hood
- 3M® Scotchlite® Reflective Material for nighttime visibility

WARMTH

BREATHABILITY

VERSATILITY

BIB

PREMIUM BIB FEATURES ZONAL INSULATION AND BREATHABLE WATERPROOFNESS

- Durable 300 denier poly shell is tear- and snag resistant and treated with superior DWR to shed snow and water from the outer shell
- Features TECH54 bonded internal laminate with 10k/10k properties
- Insulated with 150s insulation in front and 100s in back
- 3M® Scotchlite® Reflective Material for nighttime visibility
- Storm cuffs with boot lace retention snaps
- Two thigh vents

WARMTH

BREATHABILITY

VERSATILITY



NEW
BLACK/MAROON
S-XL
2861429



BLACK
Sizes: S-XL
2861554



5K/5K

DWR

3M Thinsulate
INSULATION

3M Scotchlite[®]
Reflective Material

YKK[®]
ZIPPERS

NORTHSTAR

JACKET

INSULATED AND DURABLE JACKET CONSTRUCTION DELIVERS EXCEPTIONAL WARMTH WITH MINIMAL BULK

- Durable 300 denier poly shell is tear- and snag-resistant and treated with superior DWR to shed snow and water from the outer shell
- Features TECH54 bonded internal laminate with 5k/5k properties

- Insulated with 180s insulation in body and 100s in arms
- Shock-cord adjustable bottom hem
- 3M[®] Scotchlite[®] Reflective Material for nighttime visibility
- Flattering fit and style designed for women

WARMTH

BREATHABILITY

VERSATILITY

BIB

INSULATED AND DURABLE BIB DESIGN PROVIDES ALL-DAY WARMTH WITH ZONAL INSULATION

- Durable 300 denier poly shell is tear- and snag-resistant and treated with superior DWR to shed snow and water from the outer shell
- Features TECH54 bonded internal laminate with 5k/5k properties

- Insulated with 180s insulation in upper front of legs and lower back and 100s on upper backside
- 3M[®] Scotchlite[®] Reflective Material for nighttime visibility
- Storm cuffs with boot-lace retention snaps
- Two external hand pockets

WARMTH

BREATHABILITY

VERSATILITY



NEW
GRAY | TOP
S-XL
2861457



NEW
GRAY | BOTTOM
S-XL
2861458

MIDWEIGHT BASE LAYER

ADD MORE INSULATION WHEN THE WEATHER TAKES A COLDER TURN

- Comfortable stretch fabric to allow for maximum movement
- 92% polyester, 8% spandex
- Soft brushed-fleece liner
- Warmest base layer—use for your coldest riding days

WARMTH

BREATHABILITY

VERSATILITY

LAYER:
BASE



NEW
PINK
S-XL | 2861448



TECH QUARTER-ZIP

EXCELLENT FOR LAYERING OR AS A COMFORTABLE AND STYLISH SHIRT

- High-performance garment is ideal as a mid-layer riding or as a stand-alone layer
- Four-way stretch material is breathable and moisture-wicking to keep you warm and dry
- Cut and sewn for a contoured fit

WARMTH

BREATHABILITY

VERSATILITY

LAYER:
MID



NEW
FORCE JACKET

VERSATILE, LIGHTWEIGHT JACKET IDEAL FOR LAYERING OR WEARING AS A CASUAL JACKET

- 140s 3M™ Thinsulate®
- Two external hand pockets
- One internal media pocket
- Rugged YKK® zippers
- Compactable into travel pocket

WARMTH

BREATHABILITY

VERSATILITY

LAYER:
MID



BLACK
S-XL | 2861433

MID-LAYER

LAYER FOR VERSATILITY AND WARMTH WITH THIS BREATHABLE FLEECE MID-LAYER

- Extra layer of warmth that you can add or subtract depending on activity and temperature
- 280s of breathable fleece and a wear-resistant polyester face
- Designed to fit under outer shell when riding

WARMTH

BREATHABILITY

VERSATILITY

LAYER:
MID



NEW
MAROON/PINK
S-XL | 2861450

WOMEN'S BEANIES + CAPS



NEW
REMOVABLE POM BEANIE

Green | 2861513
Gray | 2861514



NEW
ELLIPSE PATCH TRUCKER HAT

Pink | One Size | 2861549
Gray | One Size | 2861537



NEW

MAROON
S-XL | 2861438



SOFTSHELL JACKET

LIGHTWEIGHT PERFORMANCE THAT'S SURPRISINGLY WARM AND PERFECT FOR EVERYDAY WEAR

- Casual jacket armed with rugged and warm features for everyday wear
- Superior DWR prevents precipitation from saturating the jacket's exterior
- Lined with 280g of soft fleece for warmth
- Removable hood and underarm venting, three external pockets and one internal chest pocket

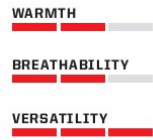

NEW

ICON HOODIE

Maroon | S-XL | 2861507



NEW

CHECKED HOODIE

Blue | S-XL | 2861610



NEW

TECH HOODIE

Gray | S-XL | 2861508



NEW
ALL IN TEE
 Olive | S-XL | 2861599



NEW
BRAP TEE
 Gray | S-XL | 2861593



NEW
ICON TEE
 Blue | S-XL | 2861596



NEW
RACING TEE
 Black | S-XL | 2861595



NEW
THINK OUTSIDE TEE
 Black | S-XL | 2861590

YOUTH RIDING GEAR

INSULATED



BLUE/ORANGE

S-XL
2860538



NAVY

S-XL
2860542

NAVY

S-XL
2860632



BLACK

S-XL
2860543

5K/5K

DWR

3M Thinsulate INSULATION

3M Scotchlite® Reflective Material

YKK® ZIPPERS

SWITCHBACK

JACKET

- Durable 300 denier poly shell is tear- and snag-resistant and treated with superior DWR to shed snow and water from the outer shell
- Features TECH54 bonded internal laminate with 5k/5k properties
- 150g insulation in body and 100g in arms
- Shock-cord adjustable bottom hem
- Two external hand pockets, one external chest pocket
- 3M® Scotchlite® Reflective Material for nighttime visibility

WARMTH

BREATHABILITY

VERSATILITY

BIB

- Durable 300 denier poly shell is tear- and snag-resistant and treated with superior DWR to shed snow and water from the outer shell
- Features TECH54 bonded internal laminate with 5k/5k properties
- Insulated with 150g insulation in front and 100g in back
- 3M® Scotchlite® Reflective Material for nighttime visibility
- Grow With Me Extension feature adjusts as your child grows taller
- Two external hand pockets

WARMTH

BREATHABILITY

VERSATILITY

TECH54



THE RIGHT GEAR MAKES ALL THE DIFFERENCE.

Nothing makes kids want to call it quits like being cold and wet. From snowmobiling to snowball fights, Polaris Engineered jackets and bibs deliver the performance kids need to enjoy the outdoors all winter long. Quality apparel keeps kids warm and dry to ensure they'll enjoy every minute out in the snow—and look forward to sharing in the sport you love.



NORTHSTAR GLOVE

- Mapped insulation with 200s on back of hand and 100s on palm
- Goggle squeeze on index finger and nose wipe on the back of thumb
- Gauntlet shock-cord closure to keep snow and cold out

Black | S-XL | 2861463



YOUTH BRAP TEE

NEW Red | S-XL | 2861600



YOUTH LIFESTYLE

TECH FULL-ZIP HOODIE

NEW
Maroon | S-XL | 2861511
Black/Blue | S-XL | 2861512

APPAREL

MEN'S APPAREL

WOMEN'S APPAREL

YOUTH APPAREL

HELMETS

GOGGLES

GLOVES

BOOTS & BEANIES
& GOGGLE BAGS

509 FOR POLARIS

IGNITE

IGNITE DUAL-PANE
CLIMATE CONTROL

BALACLAVAS

MOUNTAIN BALACLAVA

- Laser-cut breath holes
- Windproof four-way stretch material blocks wind in key areas while providing extreme comfort

NEW One Size
2861474

TRAIL BALACLAVA

- Anti-fog neoprene nose guard
- Heavier windproof four-way stretch material blocks wind in key areas while providing extreme comfort

NEW One Size
2861475

FIDLOCK

MAGNETIC TECHNOLOGY

The new lineup of 509 helmets for Polaris features Fidlock® technology, an easy-on and easy-off magnetic closure device that delivers a quick, secure closure every time.



- 👉 EASY ONE-HAND OPENING
- 🧤 EVEN WITH GLOVES
- ⊕ DOT- AND ECE-APPROVED

THE RIGHT HELMET

F O R Y O U R R I D E .

Whether you're ascending deep mountain powder or enjoying a perfectly groomed trail, 509 for Polaris has a helmet to fit your riding passion.

C H O O S E Y O U R 5 0 9 H E L M E T

V E R S A T I L I T Y



DELTA R3

Ride in complete confidence knowing you can tackle any situation with the all-in-one 509 Delta R3 with the versatility of dual-sport, full-face or open-face configurations.

M O T O



// ALTITUDE 2.0 //

Push boundaries with the strong, lightweight construction of hand-lay carbon fiber or composite with the draft-free seal of 509 goggles.

509 FOR POLARIS

NEW
R3 BLACK
S-2XL
2861467



DELTA R3

NEW
R3
BLACK/GRAY/LIME
S-2XL
2861468



509 DELTA R3 HELMET

UNLIMITED VERSATILITY IN DUAL-SPORT, FULL-FACE OR OPEN CONFIGURATIONS WITH PREMIUM PROTECTION

SHELL

- Lightweight polycarbonate

WEIGHT

- 1.680g

FEATURES

- Dual-sport, full-face or open face configuration options
- Dual-pane anti-scratch, anti-fog coated ITO electric clear shield
- Comes standard with the Fidlock® easy-open magnetic strap buckle
- Drop-down internal sun shield (amber)
- Push-button removable shield
- Removable cold-weather chin curtain
- Removable/washable liner and cheek pads
- DOT- and ECE 22.05-approved

IGNITE
FIDLOCK

BLUE
S-2XL
2861471



ALTITUDE



BLACK
S-2XL
2861469



RED/BLACK
S-2XL
2861470



BLACK/RED
S-2XL
2861472



CARBON FIBER
BLACK/LIME
S-2XL | 2861473

NEW 509 ALTITUDE 2.0 HELMET

LIGHTWEIGHT DESIGN, PERFORMANCE-INFUSED STYLE AND FEATURES WITH ALL-DAY COMFORT

SHELL

- Thermoplastic poly alloy outer shell

WEIGHT

- Composite as low as 1,200g
- Carbon fiber as low as 1,150g

FEATURES

- Strong, lightweight construction of carbon fiber or composite
- Superior fit for all-day comfort
- Integrated Pro Series breath box provides excellent ventilation and air flow
- One-piece eye-port creates draft-free seal with 509 goggles
- Magnetic Fidlock™ chin-strap technology and integrated Go-Pro™ mount
- DOT- and ECE 22.05-approved

FIDLOCK

VISIT POLARIS.COM/SNOWHELMETS TO LEARN MORE

GOGGLES

NEW BLACK

2861480



POLARIZED

NEW BLACK/RED

2861481



MIRRORED

NEW BLACK/BLUE

2861482



CLEAR



SP9 FOR POLARIS

SINISTER

SINISTER X6 509 SNOW GOGGLE



MIRRORED

- Reduces glare by reflecting light
- Maintains visibility of LCD readouts
- Paired with lighter tints to offset darkening



POLARIZED

- Substantially reduces glare & blinding
- Blocks horizontal light waves
- Decreases eyestrain

FEATURING EXCELLENT VISIBILITY, ANTI-FOG PERFORMANCE AND DURABILITY

- Incredible style and premium performance for any rider
- The Outrigger mounting strap allows the goggles to seal tight to your face
- Unique Phantom frame technology eliminates goggle-frame intrusion into field of view
- Durable polycarbonate lens is both scratch- and fog-resistant
- Oversized foam seals gaps between helmet and goggle frame for maximum warmth
- Choose from a wide range of replacement lenses in multiple colors and finishes

NEW BLACK/GRAY

2861476



SMOKE

NEW BLACK/RED

2861477



FIRE MIRROR LIGHT ROSE

NEW PINK

2861478



SMOKE

NEW BLUE

2861491



CLEAR



KINGPIN

KINGPIN 509 SNOW GOGGLE

NEW BLACK/LIME

2861479



YELLOW

FOR POLARIS

PREMIUM MATERIALS IN AN AFFORDABLE PACKAGE

- Oversized spherical lens delivers optimal peripheral vision
- Maximum anti-fog and scratch-resistant
- Contoured frame and triple-layer foam seals out cold and snow
- Removable nose piece delivers versatile cold-weather protection
- Quick-change lens technology for fast lens-tint swaps

FIND THE PERFECT LENS FOR EVERY LIGHT CONDITION AT:
POLARIS.COM/SNOWGOGGLES

GLOVES



MEN'S | S-2XL
2861461

WOMEN'S | S-2XL
2861462



NEW **NORTHSTAR** GLOVE

- Premium performance with rugged polyester and leather construction
- Reinforced leather palm provides excellent control and feel
- Men's zonal warmth of 250s of 3M® Thinsulate® on backside and 150s in palm
- Women's zonal warmth of 300s of 3M® Thinsulate® on backside and 150s in palm

INSULATION



PADDING



GRIP





MEN'S | S-2XL
2861459

NEW
REVELSTOKE
GLOVE

- Reinforced leather palm for excellent control and feel
- Adjustable wrist strap seals out snow
- Dry-zone anti-slip insert
- 150g of 3M® Thinsulate® on back of hand

- Built-in goggle squeegee on backside of glove to keep vision clear
- Touch-screen compatible

INSULATION

PADDING

GRIP

NEW
SWITCHBACK
GLOVE

- Reinforced leather palm for excellent control and feel
- Integrated goggle wipe effectively clears snow, moisture and ice
- Removable fleece liner and 150g of 3M® Thinsulate® add versatility and warmth
- Touch-screen compatible

INSULATION

PADDING

GRIP

MEN'S | S-2XL
2861460





HIGHLY VISIBLE 3M® SCOTCHLITE® REFLECTIVE MATERIAL



ICE LOCK® SOLE TECHNOLOGY



600G OF 3M® THINSULATE® INSULATION

BOA® SYSTEM VS. LACES

Push to engage. Turn to tighten. Pull for quick release. The BOA® lacing system is easier to get on and off than traditional lace-up boots and gives a perfect fit with the turn of a knob. Even with gloves on.

3M Thinsulate INSULATION **3M Scotchlite** Reflective Material

SWITCHBACK BOOT

PERFORMANCE, WARMTH AND COMFORT

- Dry-Lex® membrane keeps feet dry and 3M® Thinsulate® delivers unmatched warmth for all-day comfort
- Constructed from durable leather for long-lasting wear season after season
- Lightweight design is extremely comfortable and perfect for active riders
- Ice Lock® sole with microscopic glass shards for sure grip on slippery surfaces

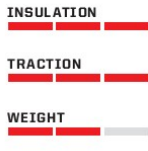

BOA® SYSTEM

Sizes: 5-14
2868527



NEW

NORTHSTAR BEANIE

Black | 2861519
Navy | 2861518





**OGIO®
9800 RIG ROLLER**

- SLED (Structural Load Equalizing Deck) system for increased durability and handling in the harshest of conditions
 - Large main compartment with adjustable dividers and padded helmet chamber
 - iFDM (integrated foam) construction throughout for added gear protection
 - Heavy-duty oversized wheels with extra clearance
 - Telescoping pull handle
 - Dimensions: 32"H x 16.5"W x 15.25"D
- 2861483**

**OGIO®
CARRY-ON BAG**

- Custom in-line skate wheels and locking retractable handles provide optimum mobility
 - 2-stage Pullman handle
 - Internal compression straps
 - Airline regulation carry-on size with 3" expansion zipper
 - Dimensions: 22"H x 14"W x 10"D
- 2861486**



**OGIO®
ROSEAU BACKPACK**

- Padded 15" laptop compartment
 - Low-profile, lined valuables pocket
 - Spacious main compartment with organizer panel
 - Wave-foam ventilated back panel
 - Dimensions: 18.5"H x 10.5"W x 7.5"D
- 2861484**



**OGIO®
EXPLORER BACKPACK**

- Easy-to-reach essential gear compartments and pockets
 - Sewn-in EVA molded compartment that protects your fragile and valuable items
 - Luggage handle pass-through for easy transport and mobility
 - Dimensions: 19.5"H x 14"W x 1.5"D
- 2861485**



**OGIO®
SPOKE BAG**

- Large main compartment with roll-out changing mat
 - Lightweight for greater carrying capacity
 - Two-stage trolley handle and reinforced replaceable wheel set
 - Durable skid guards and haul handles
 - Dimensions: 32"H x 16.5"W x 16"D
- 2861487**



MAKE EVERY
RIDE EPIC.

Deep powder. Untracked meadows. Epic lines. You live for the backcountry and we live to elevate the experience with must-have mountain essentials and premium accessories and apparel. Gear up with industry-leading PIEPS® avalanche gear, stay dry and comfortable with TECH54 riding apparel, and stow the day's essentials with adaptable storage options.

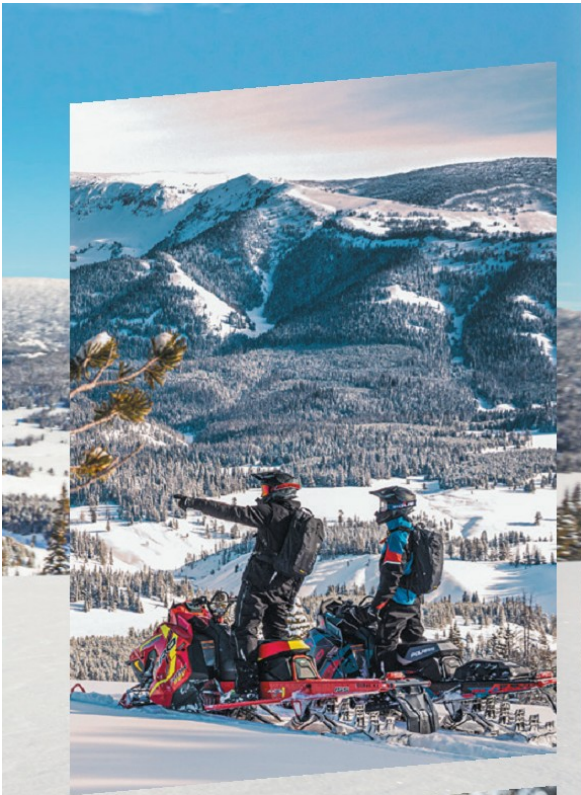

BACKCOUNTRY

TOP PICKS

APPAREL

- 509 ALTITUDE 2.0 HELMET pg 28
- MEN'S REVELSTOKE JACKET pg 06
- MEN'S REVELSTOKE BIB pg 06

ACCESSORIES

- FRONT BUMPERS pg 68
- LOCK & RIDE FLEX
- TUNNEL STORAGE SYSTEM pg 52

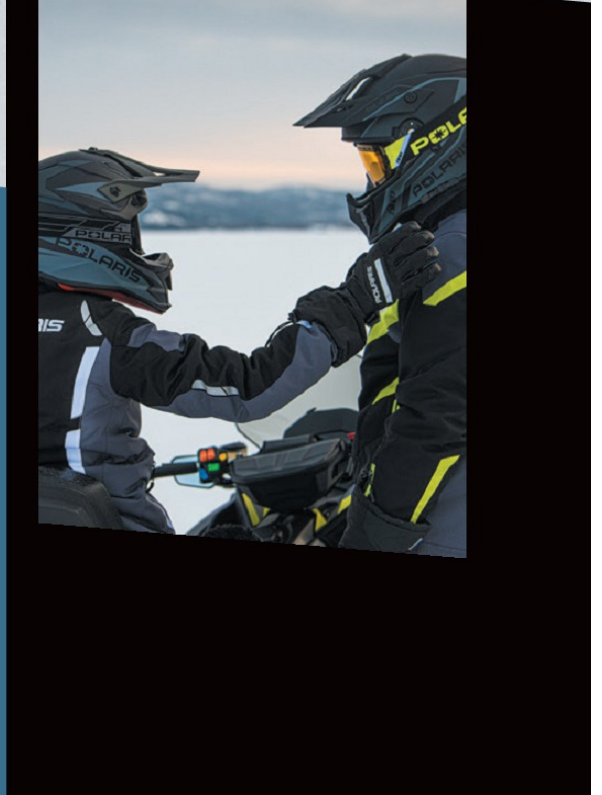

A D V E N T U R E T O U R I N G

TOP PICKS

APPAREL

- 509 DELTA R3 HELMET pg 30
- MEN'S SWITCHBACK JACKET pg 08
- MEN'S SWITCHBACK BIB pg 09

ACCESSORIES

- LOCK & RIDE FLEX
TUNNEL STORAGE SYSTEM pg 52
- WINDSHIELDS pg 66
- XL HANDGUARDS pg 72



READY FOR
ADVENTURE
BEYOND THE HORIZON.

When the snow falls, nothing can keep you from the ride. Whether you're riding for a day, a weekend or a week, be ready for anything with the right Polaris accessories and apparel. From additional storage options, heated seats, bumper protection, gauntlets and windshields, you'll be ready for wherever the next horizon lies with additional warmth, comfort and style.



MEMORIES

AT A MOMENT'S NOTICE.

Ignite your passion for winter's adrenaline rush. Make the most of every ride with the new easy-to-use Lock & Ride Flex storage and passenger seating. No matter who's riding, or what the day brings, your sled can do it all thanks to the versatility and flexibility of Polaris Engineered Accessories and Apparel.

Because when the snow falls, it's time to ride.

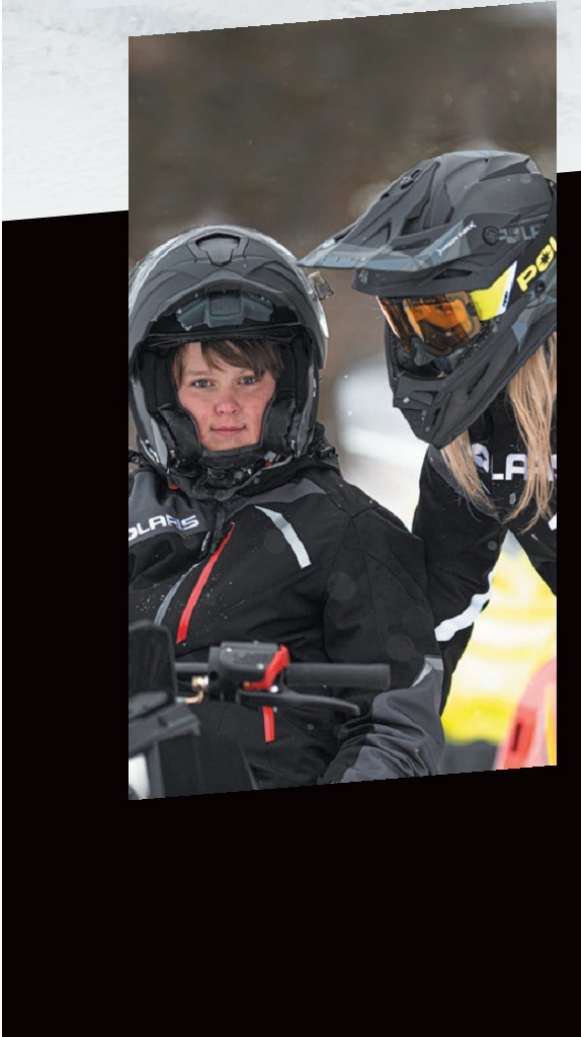

TRAIL VERSATILITY

TOP PICKS

APPAREL

509 ALTITUDE 2.0 HELMET pg 31

MEN'S NORTHSTAR JACKET pg 10

MEN'S NORTHSTAR BIB pg 11

ACCESSORIES

LOCK & RIDE FLEX

TUNNEL STORAGE SYSTEM pg 52

DEFEND HANDGUARDS pg 72

INSIGHT SIDE MIRRORS pg 73



RECREATION UTILITY

TOP PICKS

APPAREL

- 509 DELTA R3 HELMET pg 30
- MEN'S NORTHSTAR JACKET pg 10
- MEN'S NORTHSTAR BIB pg 11

ACCESSORIES

- SEATING SYSTEM pg 62
- ICE FISHING ACCESSORIES pg 61
- HITCHES pg 69



WORK OR PLAY

T H E F U N N E V E R E N D S .

On the job or on the throttle, there's more ways you can enhance your ride with Polaris Engineered Accessories and Apparel. Whether you want to add passengers, haul more gear or be prepared for anything with a winch and bumper—there's a world of work-hard, play-hard accessories waiting to enhance your ride.



LOCK & RIDE FLEX SEATING
pg 52

LOCK & RIDE FLEX STORAGE
pg 56

DESIGNED

Developed by the same engineers
who built your sled.

TESTED

Proven in grueling winter
conditions around the world.

TRUSTED

Over 65 years of building
the world's best snowmobiles.

ACCESSORIES

YOUR ULTIMATE RIDE.

Never settle for good enough. Designed, engineered and tested to the same demanding standards as our snowmobiles, Polaris Engineered accessories perfectly complement how you ride. This means they fit perfectly, mount effortlessly and perform to the highest standards in the backcountry, on the trail and everywhere in between.



WINDSHIELDS
pg 68



FRONT BUMPERS
pg 68

SKIS
pg 71



HANDGUARDS
pg 72

INTUITIVE EFFORTLESS
CONTROL.

MATRYX

MATRYX delivers a rider-centric platform and accessory collection that puts you at the center of it all. Experience a level of control and complete accessory integration that blurs the line between rider and machine. Accessories that look, feel and function as one with the snowmobile, and a revolutionary new one-step Lock & Ride Flex attachment system.



MATRYX IS OFFERED EXCLUSIVELY ON INDY VR1, XC LAUNCH EDITION & SWITCHBACK ASSAULT 146

NEW MATRYX

DEFEND HANDGUARD SIGNATURE LIGHT

• Elevated customization with signature accent lighting for handguards

2884933
ALL MATRYX

NEW MATRYX

DEFEND HANDGUARDS

• Oversized design offers increased protection and warmth, factory-color-matched

Gloss Black	2884616-266
Indy Red	2884616-293
White	2884616-599

ALL MATRYX. DOES NOT WORK WITH MID OR TALL WINDSHIELD.

NEW MATRYX

DEFEND HANDGUARD MOUNTS

• Engineered for MATRYX platform models

2884617
ALL MATRYX. DOES NOT WORK WITH MID OR TALL WINDSHIELD.

An additional passenger or increased load may require torsion spring adjustment or accessory spring options. SEE PG 84



NEW MATRYX
M2 SEAT

- All-in-one passenger seating system in standard or heated version
- Installs with new Lock & Ride Flex mounting for easy install/removal

Standard | 2884725
ALL MATRYX

Heated | 2884957
ALL MATRYX

LOCK & RIDE FLEX

NEW MATRYX
M2 SEAT STORAGE BAG

- Semi-rigid design fits securely beneath accessory M2 seat leaving room for additional tunnel storage

2884956
ALL MATRYX

LOCK & RIDE FLEX

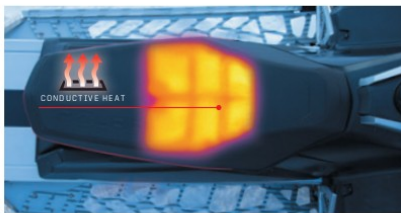

NEW MATRYX
HEATED SEAT

- Keep warm during the most demanding winter rides
- Features easy-to-use high/low/off switch for complete control
- Complete seat assembly with all mounting hardware and harness included

2884937
ALL MATRYX



11.8
LITERS

NEW MATRYX
UNDERSEAT-LINER BAG

- Fits inside factory underseat compartment for waterproof storage

2884752
ALL MATRYX



NEW MATRYX
PASSENGER FOOTREST

- Rugged extruded aluminum design adds passenger comfort and safety

2884813
ALL MATRYX

NEW MATRYX ACCESSORIES



NEW MATRYX MID WINDSHIELD

■ Smoke	2884934
ALL MATRYX	

NEW MATRYX SENTRY FRONT BUMPER

■ Gloss Black	2884817-067
■ Indy Red	2884817-293
■ Turbo Silver	2884817-402
■ Lime Squeeze	2884817-630
■ Polaris Blue	2884817-751
■ Stealth Gray	2884817-804
ALL MATRYX	

SEE PAGE 82
FOR MATRYX & AXYS REAR BUMPERS

6" SHORT



NEW MATRYX LOW WINDSHIELD

■ Gloss Black	2884936-266
■ Indy Red	2884936-293
■ Polaris Blue	2884936-751
ALL MATRYX	

23" TALL



NEW MATRYX TALL WINDSHIELD

■ Smoke	2884935
ALL MATRYX	

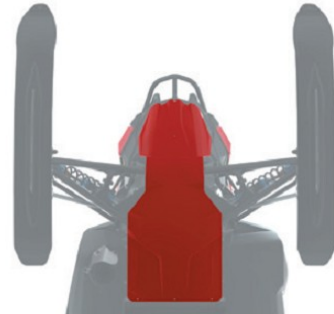

NEW MATRYX SENTRY SKID PLATE

- Add protection to belly pan and bulkhead
- Factory-color-matched customization

■ Black	2884816-070
■ Indy Red	2884816-293
■ White	2884816-599
■ Lime Squeeze	2884816-630
■ Polaris Blue	2884816-751
ALL MATRYX	



NEW MATRYX KNEE PADS

2884754 Set of Two
ALL MATRYX

FOR MATRYX COVER OPTIONS VISIT:
POLARIS.COM/SNOWCOVERS

ACCESSORIES

MATRYX,
LOOK & RIDE/FLEX

STORAGE, RACKS
& HITCHES

SEATING
& WINDSHIELDS

BUMPERS, SKID PLATES
& RUNNING BOARDS

SMS, SMOOKS
& KITS

HANDLEBARS
& ELECTRONICS

ROCK COMMAND
& P.I.D.O.

COVERS
& TRAILERING

STRAPS, STRIPS
& TRACKS

NEW
INSIGHT SIDE MIRRORS **MATRYX**

- Side-panel mount allows for use of handguards or gauntlets
- 2884815**
ALL MATRYX

SEE MORE
AT A GLANCE.

Check your rearview quickly and stay focused on the ride with new Insight Side Mirrors that integrate seamlessly into the cockpit—and never choose between handguards or mirrors again.



NEW **MATRYX**
DRIVER GAUNTLETS

- Premium nylon construction delivers protection from cold; clear poly panels allow for handlebar switch visibility
- 2884617 required for install

2884814
ALL MATRYX



NEW **MATRYX**
GRILL INSERTS

■ Gloss Black	2884979-067
■ Indy Red	2884979-293
■ Lime Squeeze	2884979-630
■ Polaris Blue	2884979-751
■ Stealth Gray	2884979-804

ALL MATRYX



12 VOLT PLUG

- 12v accessory plugs into 12v outlet, great for GPS or phone, dash mount

12v | **2884938**
ALL MATRYX

7.6
LITERS



NEW **MATRYX**
GLOVE BOX LINER

- Custom-fit organizer with four interior compartments for phone, goggles and more

2884753
ALL MATRYX



NEW **MATRYX**
KEY-OPERATED ELECTRIC START KIT

- The ultimate convenience feature you can add to your sled
- Easier to use and more consistent than pull starts
- Ideal for extreme cold conditions
- Battery required and not included

2884955
ALL MATRYX

NEW LOCK & RIDE FLEX

INTRODUCING THE NEW

LOCK & RIDE FLEX

FASTEST. EASIEST. MOST SECURE.

WE REDEFINED ACCESSORY INTEGRATION SO YOU CAN DEFINE YOUR RIDE.

The fastest, easiest and most secure accessory-mounting system in the industry. Lock & Ride Flex enables multiple configurations to easily add storage and passenger seating to your snowmobile with one simple click.

TO LEARN MORE, VISIT: [POLARIS.COM/LOCKRIDEFLEX](https://polaris.com/lockrideflex)

**LOCK & RIDE FLEX ADAPTER KIT
AVAILABLE—PG 67**



One simple click and
you're ready to go.



EASY & SECURE

- Push to secure
- Lift to release
- No turning, no twisting

- Customizable configurations
- Retro-fit compatible



NEW LOCK & RIDE FLEX SPORT TUNNEL BAG

MATRYX AXYS PRO-RIDE

- Semi-rigid design available in two profiles; fits great with M2 seat
- Oversized buckles provide easy access to gear with your gloves on
- Customizable configuration with Velcro® adjustable dividers
- Base is water-resistant to keep your gear dry

- Installation on AXYS & Pro-Ride sleds requires the Lock & Ride Flex Adapter Kit (2884939)

Low | 2884453
ALL MATRYX, ALL AXYS & PRO-RIDE
Tall | 2884454
ALL MATRYX, ALL AXYS & PRO-RIDE



NEW LOCK & RIDE FLEX ADVENTURE TUNNEL BAG

MATRYX AXYS PRO-RIDE

- Semi-rigid design available in two profiles
- Oversized buckles provide easy access to gear with your gloves on
- Customizable configuration with Velcro® adjustable dividers
- Base is water-resistant to keep your gear dry

- Installation on AXYS & Pro-Ride sleds requires the Lock & Ride Flex Adapter Kit (2884939)

Low | 2884455
ALL MATRYX, ALL AXYS & PRO-RIDE
Tall | 2884456
ALL MATRYX, ALL AXYS & PRO-RIDE



NEW M2 SEAT MATRYX

- All-in-one passenger seating system in standard or heated version
- Installs with new Lock & Ride Flex mounting for easy install/removal
- Not compatible with Lock & Ride Flex Adapter Kit

Standard | 2884725
ALL MATRYX

Heated | 2884957
ALL MATRYX

LOCK & RIDE FLEX

RETRO FIT YOUR SLED WITH LOCK & RIDE FLEX

NEW LOCK & RIDE FLEX ADAPTER KIT

AXYS PRO-RIDE

- Add Lock & Ride Flex storage to AXYS and Pro-Ride full tunnel sleds

2884939
ALL AXYS & PRO-RIDE SLEDS WITH TUNNEL T-SLOT ATTACHMENT

LOCK & RIDE FLEX

WINDSHIELD/DASH STORAGE

A WINDSHIELD BAG (LOW PRO) AXYS 5.4 LITERS

- Uses engine heat to warm/dry goggles and gloves

2880481
ALL AXYS

B MOUNTAIN DASH BAG AXYS 9.8 LITERS

- Convenient storage for two bottles of water, goggles, gloves, or anything else you need easy access to

2880375
MY16-21 PRO-RMK, MY16-21 SKS 155, MY16-21 RMK ASSAULT

C GOGGLE HANDLEBAR BAG AXYS 2.7 LITERS

- Conveniently access spare goggles from the driver's seat

2882823
ALL AXYS

D HEATED UNDERHOOD STORAGE AXYS 5.8 LITERS

- Underhood storage is ideal for storing goggles and keeping them defrosted

2882117
ALL AXYS. DOES NOT FIT TITAN.



★ TOP SELLER
LARGE



5.7 LITERS

WINDSHIELD BAG AXYS

- Bag installs inside base of windshield using stock push-dart fasteners
- Compression-molded semi-rigid material
- Engine heat warms/dries goggles and gloves

Low Pro | 2880481
ALL AXYS

Large | 2880374
ALL AXYS



ULTIMATE DEFROST BAG

PRO-RIDE

- Provides warm, dry place for goggles, gloves and more
- Rigid construction holds its shape
- Durable 1,680 denier black ballistic nylon with water-resistant coating

2879090
ALL PRO-RIDE



3.4 LITERS

UNDERHOOD GOGGLE BAG PRO-RIDE

- Heavy-duty nylon bag mounts under hood, above exhaust

2878735
ALL PRO-RIDE



HANDLEBAR MAP BAG

AXYS PRO-RIDE

- Clear poly window displays trail map for easier navigation
- Attaches easily with all-weather Velcro® strips

2882824
ALL SNOWMOBILES



CELL PHONE CHARGING BAG AXYS

- Charge your cell phone while the engine is running
- Includes wire harness, which connects to the sled's electrical system
- Use your device's charging cable to attach via USB connection inside bag

2883687
ALL MY16-21 PRO-RMK

2883786
ALL MY15-20 RUSH, MY15-21 AXYS
SWITCHBACK



**BURANDT ADVENTURE
UNDERSEAT BAG** AXYS

- Dual side-access zippers provide access to cargo when bag is installed

2881056
MY16-21 AXYS PRO-RMK, AXYS SKS, AXYS RMK ASSAULT

**WATERPROOF
UNDERSEAT
LINER BAG** AXYS

- Fits inside stock underseat bag

2882857
MY17-21 AXYS 6BA, MY18-21 SKS 146,
MY19-21 AXYS INDY 129, MY20-21 AXYS
INDY 137



11.8
LITERS

TUNNEL STORAGE



LOCK & RIDE

BURANDT ADVENTURE TUNNEL BAG **AXYS** **PRO-RIDE**

- 2" buckles provide easy access to gear with your gloves on
- Customizable configuration with Velcro® adjustable dividers

- Tray liner is water-resistant to keep your gear dry

Small | 2880969
ALL RMK, AXYS PRO-RMK, SWITCHBACK ASSAULT
Large | 2880970
ALL AXYS RMK

LARGE

14.8
LITERS

SMALL

9.2
LITERS



WEATHER-RESISTANT LID

ADJUSTABLE VELCRO® DIVIDERS

32.0
LITERS



FITS OVER THE TOP OF THE PREMIUM BACKCOUNTRY TUNNEL BAG

LOCK & RIDE

PREMIUM BACKCOUNTRY TUNNEL BAG **AXYS** **PRO-RIDE**

- Reinforced high-density EVA compression molding provides high-impact resistance and extreme tunnel protection
- Main storage allows for a customized configuration
- Bottom is designed with air-flow channel to reduce heat between the tunnel and bag

2881979 **★ TOP SELLER**

ALL PRO-RMK, SKS, RMK, SKS 146, AXYS SWITCHBACK ASSAULT, INDY 144, VOYAGEUR

PREMIUM BACKCOUNTRY MOUNTAIN JACKET

2882130

ALL PRO-RMK, SKS, RMK, SKS 146, AXYS SBA, INDY 144, VOYAGEUR. REQUIRES PREMIUM LOCK & RIDE BACKCOUNTRY TUNNEL BAG (2881979).

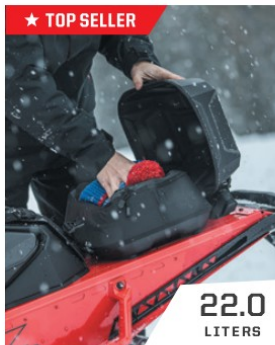

★ TOP SELLER

TRAVERSE TUNNEL BAG **AXYS** **PRO-RIDE**

- 2" buckles make it easy to access your gear with gloves on
- Water-resistant construction
- Attaches in seconds with Lock & Ride technology

2883570

FITS FULL TUNNELS 129" AND LONGER SLEDS WITH T-SLOT ATTACHMENT SYSTEM

22.0
LITERS



ADVENTURE TUNNEL BAG **AXYS** **PRO-RIDE**

- 2" buckles make it easy to access your gear with gloves on
- Includes two waterproof duffels to easily bring gear inside after the ride
- Ample storage space to carry everything you need

2882816

FITS FULL TUNNELS 129" AND LONGER SLEDS WITH T-SLOT ATTACHMENT SYSTEM. 129" INDY WILL NEED TO REMOVE STOCK UNDER-SEAT BAG TO FIT.

46.4
LITERS



10 LITERS

LOW

TALL

15 LITERS

NEW LOCK & RIDE FLEX SPORT TUNNEL BAG MATRYX AXYS PRO-RIDE

- Semi-rigid design available in two profiles
- Oversized buckles provide easy access to gear with your gloves on
- Customizable configuration with Velcro® adjustable dividers
- Base is water-resistant to keep your gear dry
- Installation on AXYS & Pro-Ride sleds requires the Lock & Ride Flex Adapter Kit (2884939)

Low | 2884453
ALL MATRYX, ALL AXYS & PRO-RIDE SLEDS WITH T-SLOT TUNNEL ATTACHMENT SYSTEM

Tall | 2884454
ALL MATRYX, ALL AXYS & PRO-RIDE SLEDS WITH T-SLOT TUNNEL ATTACHMENT SYSTEM



23 LITERS

LOW

TALL

35 LITERS

NEW LOCK & RIDE FLEX ADVENTURE TUNNEL BAG MATRYX AXYS PRO-RIDE

- Semi-rigid design available in two profiles
- Oversized buckles provide easy access to gear with your gloves on
- Customizable configuration with Velcro® adjustable dividers
- Base is water-resistant to keep your gear dry
- Installation on AXYS & Pro-Ride sleds requires the Lock & Ride Flex Adapter Kit (2884939)

Low | 2884455
ALL MATRYX, ALL AXYS & PRO-RIDE SLEDS WITH T-SLOT TUNNEL ATTACHMENT SYSTEM

Tall | 2884456
ALL MATRYX, ALL AXYS & PRO-RIDE SLEDS WITH T-SLOT TUNNEL ATTACHMENT SYSTEM



SMALL
ULTIMATE SHOVEL BAG

9.2 LITERS



LARGE
ULTIMATE SHOVEL BAG

12.3 LITERS

LOCK & RIDE ULTIMATE SHOVEL BAG AXYS PRO-RIDE

- Semi-rigid compression-molded material
- Mesh pocket inside exterior shell
- Customizable interior with adjustable Velcro® dividers
- Holds secondary shovel head, handle and essential extra gear (sold separately)
- Shovel sold separately

Small | 2881057 **TOP SELLER**
ALL PRO-RMK, SKS & SWITCHBACK ASSAULT

Large | 2882822 **TOP SELLER**
ALL PRO-RMK, RMK, SKS 155, RMK ASSAULT. WILL NOT WORK WITH FUEL CAN RACK ON 155 TUNNELS.

Hardware Replacement | 2881260
ALL AXYS & PRO-RIDE



LOCK & RIDE ADJUSTABLE FUEL-CAN RACK AXYS PRO-RIDE

- Holds most 2.5 gallon fuel cans
- Fuel cans sold separately; not through Polaris

FUEL CAN RACK STRAPS

7081248
ALL AXYS & PRO-RIDE

Aluminum | 2879790
Matte Black | 2879790-458
FITS FULL TUNNEL 129" & LONGER SLEDS WITH T-SLOT ATTACHMENT SYSTEM



SNOBUNJE® RATTLER

- Deep snow extraction device
- Hook attaches to ski; use handle to pull

2874420
ALL SNOWMOBILES



NEW

LOCK & RIDE RMK CARGO RACK PRO-RIDE

P285
CARGO BOX RMK 155"

P286
CARGO BOX RMK 144"

PRO-RIDE INDY STORAGE & RACKS



LOCK & RIDE TUNNEL BAG

- Tunnel-top storage provides storage for larger items including clothing and gloves
- Semi-rigid design retains its shape even when empty
- Large zippered opening delivers easy storage access

2882788
PRO-RIDE INDY

15.2
LITERS



9.5
LITERS

INDY EVO TUNNEL STORAGE BAG

- Provides underseat storage for quick access
- Compression-molded design provides rigidity
- Attaches easily with all-weather Velcro® strips

2883671
MV19-21 INDY EVO



3.9
LITERS

HANDLEBAR BAG

- Provides quick, convenient access to essential items
- Semi-rigid design retains its shape even when empty
- Attaches easily with all-weather Velcro® strips

2882829
PRO-RIDE INDY



8.2
LITERS

UNDERSEAT BAG

- Take advantage of underseat space with this easy-access storage bag
- Semi-rigid design retains its shape even when empty
- Attaches easily with all-weather Velcro® strips

2882786
PRO-RIDE INDY

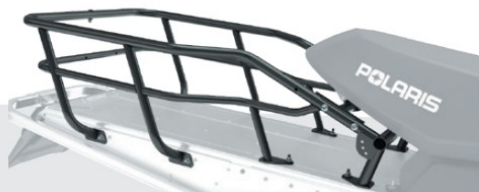

VOYAGEUR 155" EXTREME REAR RACK PRO-RIDE

- Strong, durable tubular construction
- Easy bolt-on installation

2880275
ALL 550 INDY 155

EXTREME REAR RACK LINER

Strong, durable plastic construction

2880478
ALL 550 INDY 155 (REQUIRES RACK 2880275)



CARGO BOX VOYAGEUR 155

P261
INDY 550 VOYAGEUR 155 15-16 155",
15-16, 2017-2018 WITH CARGO RACK 288275 INSTALLED

P288
VOYAGEUR 600 144" 2017-2021 (NOT IN PICTURE)

P294
550LXT 144" -2021, SWB 144" (WITH CARGO RACK 2881940-458 INSTALLED,
NOT IN PICTURE)

SWITCHBACK/RUSH STORAGE & RACKS

SWITCHBACK CARGO RACK AXYS

- Strong, durable aluminum construction
- Easy bolt-on installation; all mounting hardware included

Aluminum | 2880205

Matte Black | 2880205-458
MY15-21 AXYS SWITCHBACK 137

30
LBS STORAGE



22.3
LITERS

CARGO RACK BAG

- Weather-resistant design helps seal out snow and moisture to keep cargo dry
- Durable, semi-rigid, compression-molded design resists impacts

2881967

AXYS SWITCHBACK (REQUIRES RACK 2880205 OR 2880205-458)



10.5
LITERS

X2 BACKREST CARGO RACK BAG

- Weather-resistant design helps seal out snow and moisture to keep cargo dry
- Durable, semi-rigid, compression-molded design resists impacts

2881966

AXYS SWITCHBACK (REQUIRES RACK 2880205 OR 2880205-458 AND X2 BACK REST 2881164)



LOCK & HIDE CARGO RACK SADDLEBAGS

- Impact-modified nylon shell
- Water-resistant removable liner

2878720

MY15-21 AXYS SWITCHBACK 137 (REQUIRES RACK 2880205 OR 2880205-458)



7.2
LITERS

SOFT SADDLEBAGS

- Semi-rigid design retains its shape even when empty
- Large zippered opening delivers easy storage access

2882094

MY15-21 AXYS SWITCHBACK 137 (REQUIRES RACK 2880205 OR 2880205-458)



UNDERSEAT JOURNEY BAG

- Front of bag attaches behind seat using Tuflok® fasteners (included)
- Center cargo compartment and two side compartments
- Durable, semi-rigid compression-molded design resists impacts

2880372

AXYS RUSH & SWITCHBACK. DOES NOT WORK WITH SWITCHBACK ASSAULT.



10.8
LITERS

15
LBS STORAGE



REAR SPORT RACK AXYS

- Easy bolt-on installation; all mounting hardware included

Matte Black | 2880362-458
MY15-20 RUSH

Matte Black | 2880363-458
ALL AXYS SWITCHBACK 137

SPORT RACK BAG

- Bag attaches behind seat using Tuflok® fasteners
- Durable, semi-rigid compression-molded design resists impacts

2881464

AXYS RUSH & SWITCHBACK. DOES NOT WORK WITH SWITCHBACK ASSAULT.



15.6
LITERS



CARGO RACK 144" AXYS PRO-RIDE

- Design offers three-level storage with low, medium and high cross bars
- Angled design accommodates tie-down straps to secure cargo

Matte Black | 2881940-458

MY17-21 AXYS 144, MY18-21 SKS, ALL 550 & 600 VOYAGEUR MODELS

CARGO BAG 144"

- Semi-compressed with nylon side bag installs securely in cargo rack
- Versatile bag can be converted to a single large-cargo compartment

2881968

MY17-21 AXYS 144, MY18-21 SKS 146, ALL 550 AND 600 VOYAGEUR MODELS (REQUIRES RACK 2881940 OR 2881940-458)



ACCESSORIES

MATRIX,
LOOK & RIDE-FLEX

STORAGE, RACKS
& HITCHES

SEATING
6 WINDSHIELDS

BUMPERS, SKID PLATES
& RUNNING BOARDS

SKIS, SHOOLS
& KITS

HANDLEBARS
& ELECTRONICS

RISE COMMAND
& P.I.O.D.

COVERS
& TRAILERING

STUOS, STRAPS
& TRACKS

POLARIS TITAN



HD FRONT BUMPER

Add protection to the front of your TITAN with the TITAN HD Front Bumper with integrated front-facing winch mount. Constructed from high-strength steel and finished in black powder coat.

Black | 2882794
ALL TITAN

TITAN LIGHTBAR MOUNT

2882815
ALL TITAN



INTEGRATED 1,500LB WINCH

- Versatile and rugged winch can clear downed trees or retrieve a stuck snowmobile
- Features a powerful 1,500lb capacity
- Includes wireless winch remote
- Mounts to rear of sled with included receiver hitch
- Mounts to front of sled when using Titan HD Front Bumper (2882794). (Requires 2883850)

2882798
ALL TITAN

TITAN FRONT WINCH ATTACHMENT CABLE

- Required for utilization of the winch in the front of your TITAN snowmobile

2883850
ALL TITAN

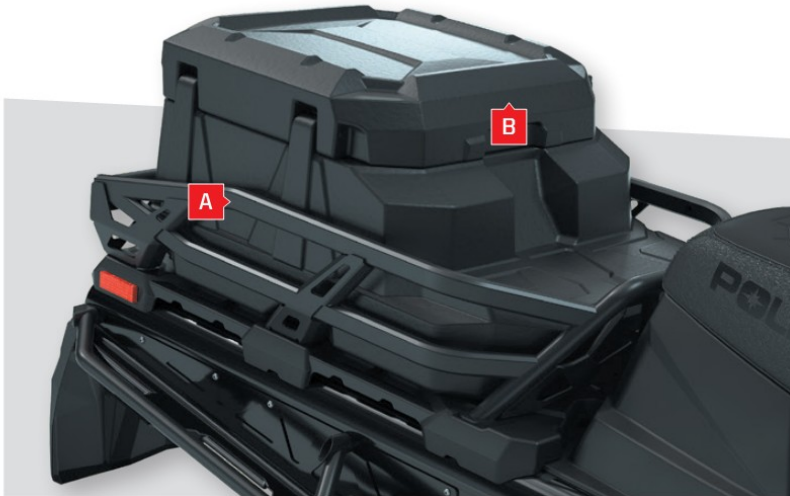

A LOCK & RIDE
VERSA REAR CARGO RACK

- Rugged aluminum powder-coated rear rack delivers versatile storage solutions
- Bolts securely to tunnel and features multiple cargo tie-down points

2882792
ALL TITAN

B LOCK & RIDE
VERSA REAR CARGO BOX

- Heavy-duty roto-molded box mounts to rear luggage rack with Lock & Ride technology
- Easy-open hinge lid can accommodate an optional padlock for security
- A total of 16 gallons of storage space

2882793
ALL TITAN

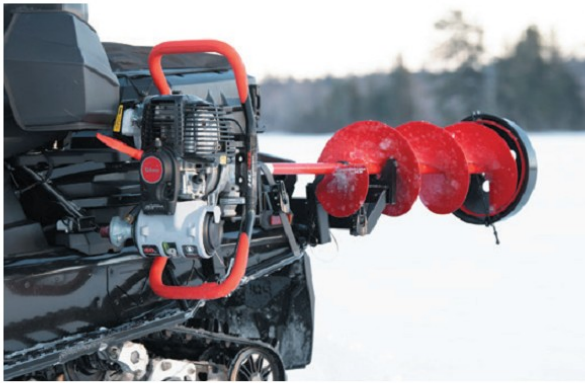

ICE AUGER RACK

- Premium steel rack securely holds your ice auger for easy transport

2882799
ALL TITAN



KOLPIN STRONGHOLD MOUNT

- Versatile and rugged mount affixes to side of tunnel
- Conveniently accepts accessory gun boots or ice-rod lockers
- Retains storage capabilities of rear rack
- Kolpin Ice Rod Locker sold separately

2882806
ALL TITAN

XL TITAN SCANDI CARGOBOX LOCK & RIDE



- Cargo box 100 liter with straps. Cargo can also be stored on the lid with straps.

P282

NOTE: (CARGO BOXES CAN ONLY BE USED WITH 1-UP SEAT, L&R SOLD SEPARATELY.)



- Cargo box with backrest, 100 liter with straps. Cargo can also be stored on the lid with straps.

P283

NOTE: (CARGO BOXES CAN ONLY BE USED WITH 1-UP SEAT, L&R SOLD SEPARATELY.)



- Cargo box 110 liter with straps. Titan Adventure. Cargo can also be stored on the lid with straps.

P284

POLARIS TITAN HEATED SEAT 

- Keep warm during the most demanding winter rides
- Features easy-to-use high/low/off switch for complete control
- Complete seat assembly with all mounting hardware and harness included

2882747
ALL TITAN

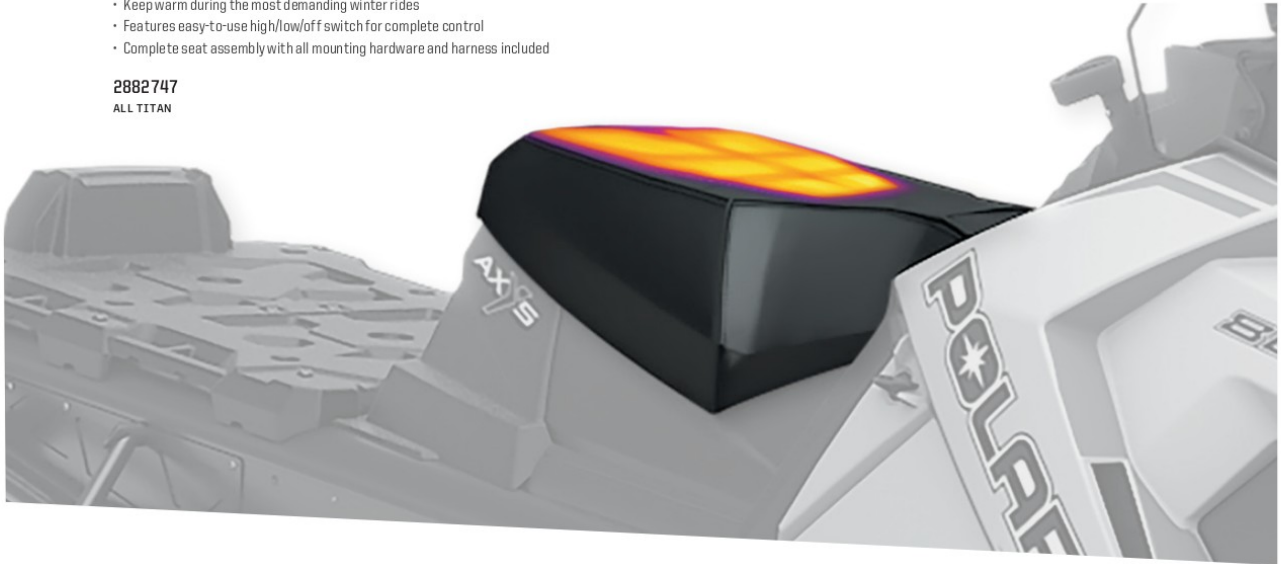

TITAN REAR-BUMPER HANDLES

- Convenient rear grab points for your Titan

2882803
ALL TITAN



TAILLIGHT GUARD

- Protect the top housing of your taillight from stowed gear or accessories
- Rugged aluminum construction secures directly to the rear cargo platform

2882809
ALL TITAN

HITCHES

HITCHES



J-HITCH TITAN SCANDI
B0131
4-BOLTS SAFETY HITCH.

RECEIVER



1.25" RECEIVER
2882795
ALL TITAN



BALL HITCH
• Allows customer to use any size ball with 3/4" shank
• Requires 1.25" receiver (2882795)
• Ball not included
2882813
ALL TITAN

HITCH ADAPTER

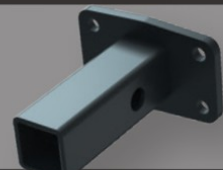

HITCH ADAPTER
• Bolts onto either the J-hook or Standard hitch to allow them to be used with 1.25" receiver installed
• Allows user to change between J-hook, Standard and Ball hitch without the use of tools
2882814
ALL TITAN



LOCK & RIDE

TITAN VERSA TOURING PASSENGER SEAT

- Attaches/removes in seconds with Lock & Ride technology
- Heated version available
- Includes heated grips & plug-in for passenger's heated visor
- Requires Versa Rear Cargo Rack (2882792)

Standard | 2882791 + TOP SELLER

ALL TITAN

Heated | 2882801

ALL TITAN

PASSENGER GAUNTLETS

All 1+1 Seat | 2883573

TITAN VERSA OR AXYS FT2 SEAT

PASSENGER FOOTRESTS AXYS MATRYX



- Add passenger comfort and security with passenger footrests

TITAN | 2882797

ALL TITAN

- Extruded aluminum design attaches directly to running board



LOCK & RIDE

UNDER-PASSENGER SEAT BAG

- Take advantage of underseat space with this easy-access storage bag
- Semi-rigid design retains its shape even when empty
- Attaches easily with Velcro® strips

2882807

ALL TITAN



CARGO BOX BUNGEE NET (EXTERIOR) AXYS

- Expands storage of the Lock & Ride Versa Rear Cargo Box
- Secure extra cargo to the exterior of the cargo box for easy access and increased capacity

2884300

ALL TITAN

RUNNING BOARD CLOSE-OUT PLATES

- Aids in water and slush protection when riding in wet conditions
- Premium polyethylene design delivers lightweight protection

2882810

ALL TITAN

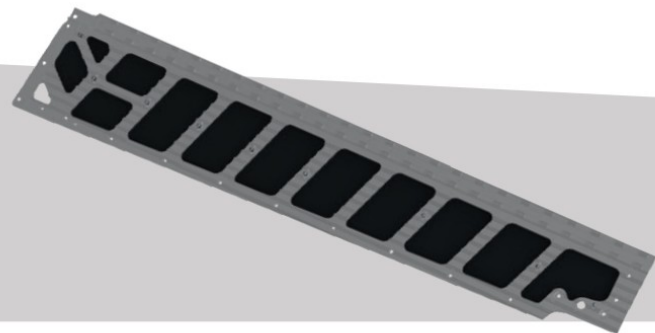

SEATING

LOCK & RIDE

FT2 PASSENGER SEAT **AXYS**

- Includes backrest, seat and handholds
- Heated grips & plug-in for passenger's heated visor
- Installs/removes easily in seconds with Lock & Ride technology
- Requires FT2 Rear Seat Rack (2883646)

Standard | 2883637 **TOP SELLER**
MY19-21 AXYS INDY 129 & 137, MY19-21 INDY SP, ALL AXYS SBA, ALL AXYS 144 VOYAGEUR (REQUIRES RACK 2883646)

Heated  | 2884208
MY19-21 AXYS INDY 129 & 137, MY19-21 INDY SP, ALL AXYS SBA, ALL AXYS 144 VOYAGEUR (REQUIRES RACK 2883646)

FT2 REAR SEAT RACK **TOP SELLER**

- Attaches in seconds with Lock & Ride technology
- Made of powder-coated high-quality steel

2883646
MY19-21 AXYS INDY 129 & 137, MY19-21 INDY SP, ALL AXYS SBA, ALL AXYS 144 VOYAGEUR



FT2 UNDER-RACK BAG **TOP SELLER**

- Easy access with weather-resistant zipper
- Compression-molded design provides rigidity
- Attaches directly to rack with all-weather Velcro®

2883714
MY19-21 AXYS INDY 129 & 137, MY19-21 INDY SP, ALL AXYS SBA, ALL AXYS 144 VOYAGEUR (REQUIRES RACK 2883646)

PASSENGER FOOTRESTS **AXYS** **MATRYX**

- Add passenger comfort and security with passenger footrests
- Extruded aluminum design attaches directly to running board

SWITCHBACK | 137 | 2882817
AXYS SWITCHBACK
AXYS | 129/137/144 | 2883571
MY19-21 AXYS INDY 129 & 137, ALL AXYS SBA





PASSENGER GAUNTLETS

All 1+1 Seat | 2883573
TITAN VERSA OR AXYS FT2 SEAT



HAND-WARMER POWER KIT

• Required to power the passenger hand-warmers on MY17-18 AXYS 144 sleds
2883851
MY17-18 SWITCHBACK SP, MY17-18 SWITCHBACK ASSAULT, MY17-18 INDY VOYAGEUR 144

NEW



CARGO BOX FT2 2-UP-SEAT

P287



HEATED SEAT **MATRYX** **AXYS**

- Keep warm during the most demanding winter rides
- Features easy-to-use high/low/off switch for complete control
- Complete seat assembly with all mounting hardware and harness included

Black | 2882819
MY15-20 RUSH, MY15-21 AXYS SWITCHBACK, MY17-21 AXYS SWITCHBACK ASSAULT, MY18-21 SKS 146, MY17-21 RMK 144, MY17-21 VOYAGEUR 600 144, MY19-21 INDY 129, MY20-21 INDY 137

NEW Matryx | 2884937
ALL MATRYX

WINDSHIELDS **AXYS**



DEEP SNOW MID WINDSHIELD
Gloss Black | 2882058

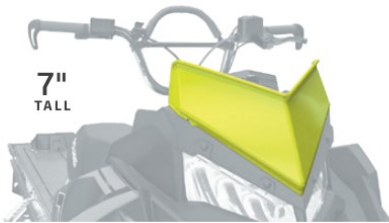

7"
TALL

LOW WINDSHIELD

AXYS

Black/Gray	2880385
White/Black	2880386
Red/White	2880387
Blue/White	2881244
Orange/Black	2881245
White	2882062
Lime Squeeze	2882826

ALL AXYS



13"
TALL

DEEP SNOW MID WINDSHIELD

AXYS

Blue	2881053
White	2881054
Matte Black	2881055
Red	2881436
Gloss Black	2882058

ALL AXYS

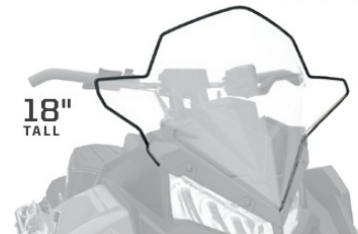

18"
TALL

FLATLAND MID WINDSHIELD

AXYS

Clear	2880389
Gloss Black	2880390
White	2880391
Red	2880392

ALL AXYS



20"
TALL

★ TOP SELLER

TALL WINDSHIELD

AXYS

Smoke	2880394
-------	---------

ALL AXYS



24"
TALL

EXTRA TALL WINDSHIELD

AXYS

Clear	2883078
-------	---------

ALL AXYS



25"
TALL

FULL COVERAGE WINDSHIELD

Clear	2882796
-------	---------

ALL AXYS

WINDSHIELDS **PRO-RIDE**

WIDE WINDSHIELD
Clear | 2878512



ACCESSORIES

MATRIX,
LOOK 6 RIDE FLEX

STORAGE, RACKS
& HITCHES

SEATING
6 WINDSHIELDS

BUMPERS, SKID PLATES
& RUNNING BOARDS

SMS, SHOCKS
& KITS

HANDLEBARS
& ELECTRONICS

RISE COMMAND
& P.I.D.O.

COVERS
& TRAILERING

STUCCO STRIPS
& TRACKS

7"
TALL



LOW WINDSHIELD

PRO-RIDE

Black	2878779
White	2879097

ALL PRO-RIDE

14"
TALL



MID WINDSHIELD

PRO-RIDE

Smoke	2877841
Matte Black	2879828
White Gloss	2879829

ALL PRO-RIDE

24"
TALL



WIDE WINDSHIELD

PRO-RIDE

Clear	2878512
-------	---------

ALL PRO-RIDE

24"
TALL

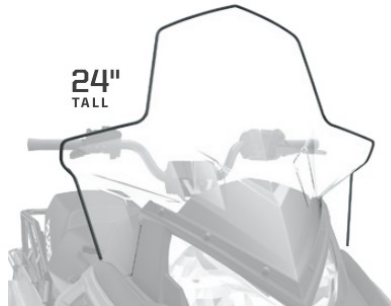

EXTRA-WIDE TALL WINDSHIELD

PRO-RIDE

Clear	2879156
-------	---------

ALL PRO-RIDE

BUMPERS



MONARCH **AXYS**

<input type="checkbox"/> Bright White	2883681-133
<input type="checkbox"/> Indy Red	2883681-293
<input type="checkbox"/> Matte Black ★ TOP SELLER	2883681-458
<input type="checkbox"/> Lime Squeeze ★ TOP SELLER	2883681-630
<input type="checkbox"/> Orange Burst	2883681-647
<input type="checkbox"/> Velocity Blue	2883681-689
<input type="checkbox"/> Matte Gold Metallic	2883681-703
<input type="checkbox"/> Sky Blue	2883681-737

ALL AXYS

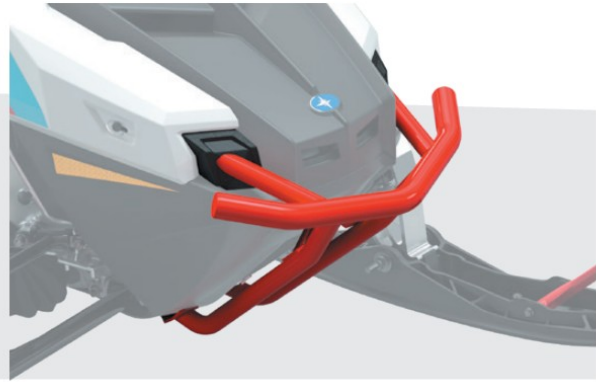

ULTIMATE **PRO-RIDE**

<input type="checkbox"/> Raw	2879727
<input type="checkbox"/> Bright White	2879727-133
<input type="checkbox"/> Indy Red	2879727-293
<input type="checkbox"/> Matte Black	2879727-458

ALL PRO-RIDE

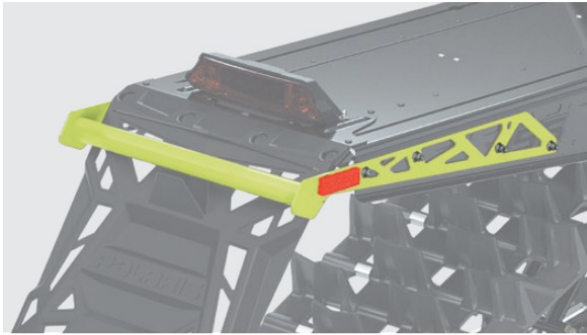

EXTREME 144" // 155"/163" // 174"

COLORS	144"	155"/163"	174"
<input type="checkbox"/> Bright White	2881941-133	2880993-133	2881754-133
<input type="checkbox"/> Indy Red	2881941-293	2880993-293	2881754-293
<input type="checkbox"/> Matte Black	2881941-458	2880993-458	2881754-458
<input type="checkbox"/> Lime Squeeze	2881941-630	2880993-630	2881754-630
<input type="checkbox"/> Orange Burst	2881941-647	2880993-647	2881754-647
<input type="checkbox"/> Velocity Blue	2881941-689	2880993-689	2881754-689
<input type="checkbox"/> Matte Gold Metallic	2881941-703	2880993-703	2881754-703
<input type="checkbox"/> Sky Blue	2881941-737	2880993-737	2881754-737

144" FITMENT: MY17-21 AXYS SBA, MY17-21 AXYS SWITCHBACK SP, MY17-21 VOYAGEUR 600, MY17-21 RMK 144. 155"/163" FITMENT: ALL MY16-MY21 PRO-RMK, RMK ASSAULT 6 SKS. 174" FITMENT: MY17-21 PRO-RMK 174.



ELITE PRO **AXYS**

<input type="checkbox"/> Bright White	2882926-133
<input type="checkbox"/> Indy Red	2882926-293
<input type="checkbox"/> Matte Black	2882926-458
<input type="checkbox"/> Lime Squeeze	2882926-630
<input type="checkbox"/> Orange Burst	2882926-647
<input type="checkbox"/> Velocity Blue	2882926-689
<input type="checkbox"/> Sky Blue	2882926-737

MY15-20 RUSH, MY15-21 AXYS SWITCHBACK

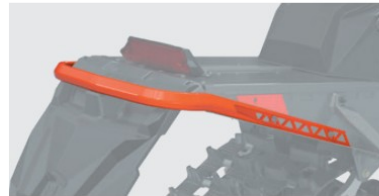

INDY XC ELITE PRO **MATRYX AXYS**

<input type="checkbox"/> Gloss Black	2884257-067
<input type="checkbox"/> Bright White	2884257-133
<input type="checkbox"/> Indy Red	2884257-293
<input type="checkbox"/> Turbo Silver	2884257-402
<input type="checkbox"/> Lime Squeeze	2884257-630
<input type="checkbox"/> Orange Burst	2884257-647
<input type="checkbox"/> Sky Blue	2884257-737
<input type="checkbox"/> Polaris Blue	2884257-751
<input type="checkbox"/> Stealth Gray	2884257-804

ALL MATRYX, AXYS INDY 129, AXYS INDY 137 AND AXYS SWITCHBACK ASSAULT



KNEE PADS **PRO-RIDE**

2878195 | Set of Two
ALL PRO-RIDE

SKID PLATES + HITCHES

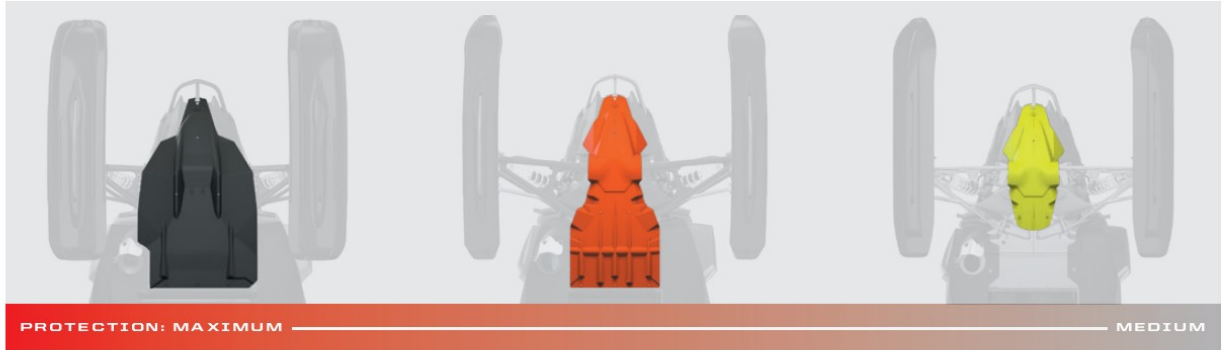

HIGH COVERAGE AXYS

- Provides the greatest amount of underbelly protection
- Gives a completed and customized look
- Rugged and lightweight UHMW material
- Note that this may hinder deep-snow performance

Black	2882748-070
-------	-------------

ALL AXYS. NOT RECOMMENDED WITH RMK.

ULTIMATE AXYS

- Enhances protection of belly pan and bulkhead
- Includes all mounting hardware

Black	▲ TOP SELLER	2880383-070
Bright White		2880383-133
Indy Red		2880383-293
Voodoo Blue		2880383-619
Lime Squeeze		2880383-630
Orange Burst		2880383-647

ALL AXYS

EXTREME AXYS

- Extended length delivers extra protection for belly pan and bulkhead
- Includes all mounting hardware

Black	2880384-070
Bright White	2880384-133
Indy Red	2880384-293
Voodoo Blue	2880384-619
Lime Squeeze	2880384-630
Orange Burst	2880384-647
Velocity Blue	2880384-689

ALL AXYS

J- HITCH

B0221

J-Hitch can be mounted on all snowmobile units from MY 1998-2020.

Mounts for each model of snowmobile are listed to the right and are available in black color.

More mounts can be purchased just contact your local dealer for hitch to your model of snowmobile.



- » B0130 J-Hitch Widetrack 6T/LX/IQ
- » B0131 J-Hitch TITAN Safety, 4-Bolt
- » B0221 J-Hitch | MY 1989-2021
- » MN1007 K-Mount AXYS RUSH/AXYS SWB | MY 15-20
- » MN1002 K-Mount RUSH | MY 11-14
- » MN1002 K-Mount SWB 136" PRO-RIDE | MY 12-14
- » B0255 K-Mount 600/800 INDY XC 129" | MY 2019-2020
- » B0255 K-Mount 650/850 VR1/INDY XC 129" MATRYX 2021
- » B0256 K-Mount 600/850 INDY XC137" | MY 2020
- » B0256 K-Mount 650/850 VR1/INDY XC 137" MATRYX 2021
- » B0251 K-Mount AXYS RMK 6 SKS 155" | MY 16-21
- » B0254 K-Mount AXYS SKS 146" 600/800 Switchback Assault 144" 800 Switchback SP 144" | MY 2019-
- » B0254 K-Mount 650/850 Switchback 146" MATRYX 2021
- » B0252 K-Mount AXYS SWB Assault/SP 144", SKS 146" | MY 18
- » B0245 K-Mount RMK 144" | MY 12-20
- » B0246 K-Mount RMK 155" | MY 12-15
- » B0247 K-Mount RMK 163" | MY 11-15
- » B0248 K-Mount INDY Voyageur 550 14, 550 Adventure X2 | MY 14-16
- » B0245 K-Mount 600 INDY VOYAGER | MY 14-16
- » B0236 K-Mount IQ 121" 08-2012, IQ SWB 136" | MY 08-10
- » B0245 K-Mount Switchback 144" | MY 11-15
- » B0244 K-Mount INDY 121", INDY EVO | MY 19-20
- » B0232 K-Mount 600 IQ LXT Touring | MY 11-14
- » B0236 K-Mount 550 IQ LXT Touring | MY 11-13
- » B0232 K-Mount Touring | MY 07-12
- » B0234 K-Mount RMK 144" | MY 07-11
- » B0235 K-Mount RMK 155" | MY 07-10
- » B0237 K-Mount 600RR | MY 08-09
- » B0249 K-Mount 550 INDY VOYAGER | MY 15-16
- » B0249 K-Mount 550 INDY Adventure | MY 15-16

SHOCKS



ÖHLINS® HIGH PERFORMANCE SHOCKS

- P-Type Shocks with springs included. Fully re-buildable.
- Adjustable compression and rebound adjuster.
- SWB shocks are updated for 2019 models.
- High

*ÖHLINS SHOCKS FOR TITAN IS AVAILABLE. CONTACT YOUR DEAREST DEALER (SWB ASSAULT, NO SPRING INCLUDED)

- PB610 | FRONT PRO RMK 36" (PAIR), Q-ADJUST 19-
- PB607 | FRONT RMK/SKS 17-19 (PAIR), 800 SKS 146" 19-
- PB608 | CENTER RMK/SKS 17-21
- MN011 | CENTER 36PC, RMK KHAOS 20-
- PB609 | REAR RMK/SKS 17-21
- PB614 | FRONT SWB ASSAULT (PAIR) 17-21
- PB615 | CENTER SWB ASSAULT 17-20 | SKS 146" 19-
- PB616 | REAR SWB ASSAULT 17-20, SKS 146" (36) 19-

WALKER EVANS® VELOCITY SHOCK UPGRADE KIT AXYS

- Race-proven featuring position-sensitive reservoir for a wider range of performance
- Calibrated for ultimate control and comfort with advanced bottoming-resistance technology

2884597
ALL AXYS 129

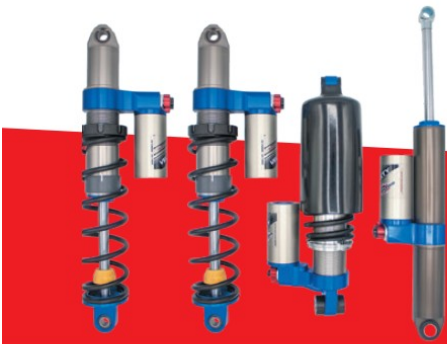

FOR ADDITIONAL SHOCKS VISIT:
POLARIS.COM/SUSPENSION



RMK EVO UPGRADE KIT AXYS

- Comes with everything you need to evolve your RMK EVO as the rider's skill increases
- Includes IFS shocks, springs and all the parts needed for full power conversion

2884251
ALL RMK EVO



INDY EVO UPGRADE KIT AXYS

- Comes with everything you need to evolve your INDY EVO as the rider's skill increases
- Includes tie rods, control arms, spindles, shocks and more

2883939
ALL INDY EVO



RMK REACT FRONT SUSPENSION KIT AXYS

- Comes with everything you need to convert your AXYS PRO-RMK to a 36" wide front end
- Includes shocks, upper and lower control arms, tie rods, sway bar and all hardware

2883686-309
ALL MY16-19 PRO-RMK

NEW REAR TORSION SPRING KITS MATRYX AXYS

CUSTOMIZE YOUR RIDE BASED ON TOTAL RIDER WEIGHT
(COMBINED WEIGHT OF RIDER, GEAR AND/OR PASSENGER)

129/137 Light Duty	2884973
129/137 Heavy Duty	2884974
129/137 Extra Heavy Duty	2884975
144/146 Light Duty	2884976
144/146 Heavy Duty	2884977

MATRYX 129/137/146, AXYS 129/137/144

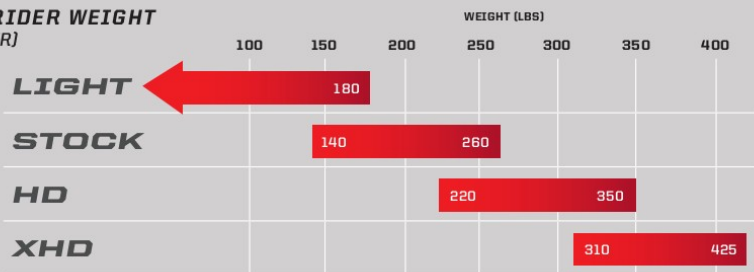

SKIS



Give your sled a custom-finished look with factory-color-matched skis, ski hoops and spindles. The combinations are endless, and this is a perfect way to complement any ArcticFX® sled wrap.



GRIPPER SKI

AXYS PRO-RIDE

- Deep 1 1/2" keel provides positive steering in deep, loose mountain snow
- Wide 6 3/4" ski delivers increased flotation
- Top traction surface for boot stepping on ski
- Includes black ski toe and hardware; carbide skags required (sold separately; see chart)
- Sold individually

Black	2877679-070
Indy Red	2877679-293
White	2877679-570

ALL MATRIX, AXYS 6 PRO-RIDE



PRO-FLOAT SKI

AXYS PRO-RIDE

- Adapted, 9.5" wide Pro-Steer ski design provides 45% more flotation for off-trail deep-snow performance
- Includes black ski toe
- Sold individually

Black	2880482
-------	---------

ALL AXYS



PRO-STEER SKI

AXYS PRO-RIDE

- Engineered keel design and shortened skag perfect for the trail
- Supportive ribs for torsional stiffness
- No-slip traction atop ski
- Alternate ski stop may be required
- Includes black ski toe and hardware
- Sold individually

Black	2879152-070
Bright White	2879152-133
Indy Red	2879152-293

ALL MATRIX, AXYS 6 PRO-RIDE



POLARIS SKI HOOPS

- Adds custom style

Black	2876062-070
Bright White	2876062-133
Indy Red	2876062-293
Lime Squeeze	2876062-630
Orange Burst	2876062-647
Velocity Blue	2876062-689

ALL POLARIS SKIS



SPINDLES

- Strong, lightweight aluminum construction with same tolerances as stock spindles
- Colored finish resists chipping and wear
- Exact replacement for stock spindles
- Color-matched spindles add a custom look to snowmobile

RUSH/SWITCHBACK FITMENT: MY15-20 RUSH, MY15-21 SWITCHBACK 137, MY17-21 SBA 6
ALL TITAN
FORGED RMK FITMENT: ALL AXYS PRO-RMK. DOES NOT FIT 15S ASSAULT.

	RUSH/ SWITCHBACK	FORGED RMK
Black	N/A	2884205-067
Bright White	N/A	2884205-133
Indy Red	2881409-293	2884205-293
Matte Black	2881409-458	N/A
Lime Squeeze	2881409-630	2884205-630
Orange Burst	2881409-647	2884205-647
Velocity Blue	2881409-689	N/A
Sky Blue	N/A	2884205-737

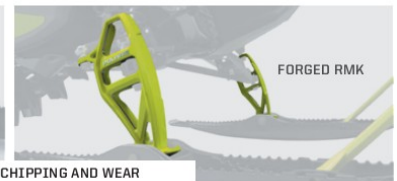

COLORED FINISH RESISTS CHIPPING AND WEAR

HANDLEBARS



PROTAPER® HANDLEBAR WITH HEATED GRIPS

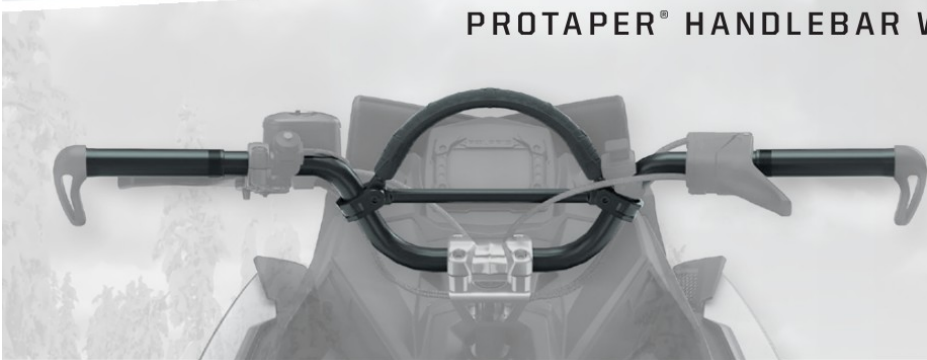

- ProTaper® handlebar allows riders to customize their handlebar height for their riding style
- Handlebar hooks sold separately (1823339-070)

5" Rise | Black | 2881235
 6" Rise | Anodized Gray | 2881236
 7" Rise | Silver | 2881237
 ALL AXYS RMK WITH 600/800 ENGINE

5" Rise | Black | 2883835
 6" Rise | Anodized Gray | 2883836
 7" Rise | Silver | 2883837
 ALL AXYS RMK WITH 850 ENGINE

HANDLEBAR ACCESSORIES



MOUNTAIN HOOP

2882118
 ALL STRAIGHTBAR APPLICATIONS



ROX® ADJUSTABLE BAR RISER

2881410
 MY19-21 VOYAGEUR, MY19-21 AXYS SBA, MY19-21 AXYS SWITCHBACK ADVENTURE, MY19-21 AXYS SWITCHBACK, MY19-20 RUSH, MY19-21 RMK 144, MY19-21 INDY AXYS XC, MY19-21 INDY SP
 Increase handlebar height from 2.5" to 4"



HANDLEBAR HOOK

2872482-070
 DOES NOT FIT PROTAPER® BARS

HANDGUARDS



XL HANDGUARDS

- Oversized for increased wind protection
- Durable, compression-molded design
- Mounts included

2884258
 ALL AXYS STRAIGHTBAR APPLICATIONS



POLARIS HANDGUARDS

- Durable, impact-resistant plastic
- Mounts required; sold separately

Red 2879193
 Black * TOP SELLER 2879192
 White 2879194

ALL SNOWMOBILES

HANDGUARD MOUNTS * TOP SELLER

- Strong mounts ensure proper handguard installation
- Easy instal: mounts directly onto handlebar

2880939
 ALL AXYS STRAIGHTBAR APPLICATIONS

RMK HANDGUARD MOUNTS

- Strong mounts ensure proper handguard installation
- Installs securely on any ProTaper® handlebar

2881241-458
 ALL AXYS RMK WITH PROTAPER® BARS

REQUIRES A MOUNT



NEW
DRIVER GAUNTLETS
AXYS

- Premium nylon construction delivers protection from cold; clear poly panels allow for handlebar switch visibility

2883716
ALL AXYS

MIRRORS



HANDLEBAR MIRRORS

- Can be used with stock handlebar pad
- Sold as a pair

2876297
ALL PRO-RIDE



★ TOP SELLER

MIRRORS

- Wide-angle view; non-fogging glass
- Folding design for use with cover
- Includes mounting hardware
- Sold as a pair

2880292
ALL AXYS



★ TOP SELLER

HOOD MOUNT MIRRORS

- Wide-angle view; non-fogging glass
- Folding design for use with cover
- Includes mounting hardware
- Sold as a pair

2877803
ALL PRO-RIDE

ELECTRONICS



BATTERY (REQUIRED FOR ELECTRIC START KITS)

Sealed, Non-Spill | 4013045: YTX20
E04999: ETX20
ALL AXYS®, PRO-RIDE®



TETHER SWITCH ★ TOP SELLER

- Shuts off vehicle if you're separated from it
- Easy to install
- Mounts directly on pod, connects to prewired harness

2874379
ALL 550 600 &
800 SNOWMOBILES

2883823
ALL 650/850 ENGINES



KEY-OPERATED ELECTRIC START KIT

- The ultimate convenience feature you can add to your sled
- Easier to use and more consistent than pull starts
- Ideal for extreme cold conditions
- Battery required and not included

★ TOP SELLER | 2881243
MY16-21 AXYS RMK 600 155
MY16-19 AXYS RMK 800

2883931
ALL 850 RMK

2879833
VOYAGEUR 550, INDY 550

★ TOP SELLER | 2880396
MY15-19 800 AXYS 120"-146"
MY15-21 600 AXYS 120"-146"

2883849
ALL 850 AXYS 120"-146"
2879330
ALL PRO-RIDE

2884776
MY20-21 800 AXYS 120"-146"
2884777
MY20-21 AXYS RMK 800

12 VOLT/RCA PLUGS

- 12v accessory plugs into 12v outlet, great for GPS or phone, dash mount
- RCA adapter allows you to plug in a heated face shield or vest
- RCA power plug includes all hardware required to add an RCA outlet

12v ★ TOP SELLER | 2878475
ALL AXYS, PRO-RIDE

RCA Power Plug ★ TOP SELLER | 2883824
ALL 650/850 ENGINES

RCA Adapter



RCA Adapter | 2878227
ALL AXYS & PRO-RIDE

RCA Power Plug (not shown) ★ TOP SELLER | 2878780
ALL AXYS & PRO-RIDE

RIDE COMMAND

POLARIS RIDE COMMAND

STAY CONNECTED



NEW 7S SOFT-TOUCH DISPLAY

THE MOST INTELLIGENT, INTERACTIVE AND INTUITIVE DISPLAY IN THE INDUSTRY

- 7" full-color, high-resolution LCD display with a glove-friendly touch-screen
- Enables Group Ride tracking without cell signal via V2V (Vehicle-to-Vehicle) technology
- View and share completed rides, with 3D flyover, in the RIDE COMMAND App
- Access to trails and topographical maps off-line, so you never have to worry about getting lost

- Full display integration through left-handlebar control and 5-way display button
- Plan your ride via the RIDE COMMAND website, seamlessly sync via RIDE COMMAND App on mobile device and display with Bluetooth® or USB
- Multiple customizable gauge screens allow you to configure the information most important to you

2884971
ALL MATRYX

7S SOFT-TOUCH DISPLAY INSTALL KIT

- Required for 7S Soft-Touch Display installation

2884972
ALL MATRYX



To download the RIDE COMMAND APP for free, text SN01 to 82350



POLARIS INTERACTIVE DIGITAL DISPLAY (P.I.D.D.)

SIMPLE AND SEAMLESS; CONNECTED POLARIS INTERACTIVE DIGITAL DISPLAY

- 4.3" full-color, high-resolution LCD screen
- RIDE COMMAND GPS mapping offers exact location information
- Vehicle diagnostics including battery voltage, engine temperature and fault codes
- Bluetooth® connectivity to smartphone
- Toggle through display modes with handlebar control
- Export trip data to USB drive

★ TOP SELLER 2881554

MY15-21 AXYS, MY10-21 PRO-RIDE (EXCLUDING 550 MODELS). MUST ORDER INSTALL KIT WITH DISPLAY. REQUIRED PARTS TO INSTALL FOR POLARIS INTERACTIVE DIGITAL DISPLAY.



P.I.D.D. INSTALL KIT

AXYS | 2880493
ALL AXYS 600/800
(DOES NOT FIT TITAN)

PRO-RIDE | 2880495
ALL PRO-RIDE SNOWMOBILES
(EXCLUDES 550 ENGINES)

2883844
ALL TITAN

FURTHER ENHANCEMENTS WHEN PAIRED WITH RIDE COMMAND APP INCLUDING GROUP RIDE FUNCTION AND LOCAL WEATHER INFORMATION

DON'T HAVE AN ELECTRIC START?

FOR A BETTER EXPERIENCE WITHOUT ELECTRIC START, INSTALL THE P.I.D.D. POWER-UP KIT

ADVANTAGES INCLUDE:

- Maintain GPS lock when you start your sled back up. Without battery kit, satellite will need to relocate, which can take up to 30 seconds while moving.
- Display will not shut down and reboot every time your sled is shut off
- Display has ability to run while sled is turned off, which allows you to use the screen while stopped

P.I.D.D. POWER-UP KIT

2882200
ALL AXYS 600/800
(DOES NOT FIT TITAN)

2884303
ALL 850 ENGINES



COVERS



CONVERTIBLE COVERS Advanced Polyester Blend That Adapts to Multiple Accessory Configurations

- Convertible cover expands and adapts to fit various accessory configurations
- Advanced polyester blend for increased protection for your snowmobile

MATRYX Exclusive Features

- MATRYX redesigned cinch straps are easier to use and hold secure for a premium fit
- Convertible design expands and adapts to fit various MATRYX accessory configurations

M
A
T
R
Y
X
A
X
Y
S

All AXYS Full Tunnel 129, 137, 144 & 146	★ TOP SELLER	Convertible	2883568
All TITAN	★ TOP SELLER	Convertible	2882800
NEW MATRYX Cover		Convertible	2884750

Only Polaris offers a tailored solution for your sled with unmatched reliability and performance.

PREMIUM POLYESTER Premium UV-Resistant

- Lightweight, custom fit and extreme protection for the ultimate trailering cover
- Premium UV-resistant and water-repellent capability, great for extended outdoor storage
- Adapts to a full range of windshield heights and secures with integrated straps

P
R
O
-
R
I
D
E
A
X
Y
S

PRO-RMK/SKS	%	2881042
RMK ASSAULT	%	2881042
RUSH	%	2880431
SWITCHBACK	%	2880431
SWITCHBACK ADVENTURE	%	2880431
RUSH	Full	2882223
SWITCHBACK	Full	2882224
SWITCHBACK WITH RACK/ADVENTURE	Full	2882225
SWITCHBACK 144	Full	2882133
PRO-RMK 155 / SKS 146/155	Full	2882133
RMK ASSAULT 163/174	Full	2882134

CANVAS Durable Cold-Weather Flexibility

- Coated, heavy-gauge canvas remains flexible in extreme cold temperatures
- Adjusts to a full range of windshield heights and secures with integrated straps
- Water-repellent, UV-resistant and versatile for trailering or storage

P
R
O
-
R
I
D
E
A
X
Y
S

RUSH/SWITCHBACK WITH SPORT RACK	Full	2882136
RUSH	Full	2882135
SWITCHBACK 137	Full	2882137
SWITCHBACK ADVENTURE WITH RACK	Full	2882138
SWITCHBACK ASSAULT 144	Full	2881969
PRO-RMK 155 / SKS 146/155	Full	2881969
RMK 163/174	Full	2881980
INDY 121/INDY EVO	Full	2878725
550 INDY 144	Full	2879845
INDY VOYAGEUR 144	Full	2879845
INDY LXT	Full	2880515
INDY VOYAGEUR 144/155 WITH 2-UP SEAT	Full	2880515
INDY VOYAGEUR 155	Full	2880516

NEW OVERNIGHT COVER

- Lightweight and packable; ideal for overnight multi-day trips or parked in a shop

2884749
ALL MATRYX

UNDERCOVER

- Made to go under Polaris snow covers to provide an additional level of protection
- Easy to install and remove

2881981
ALL AXYS





NEW
**CALIBER®
TRAX WHEELS 2.0**

- Tapered sides allow track to easily drop in place
- Specifically designed to accommodate all track pitches—2.52", 2.86", 3.0" and 3.5"
- Oversized 5" caster wheels make moving a breeze
- 500lb rating

2884384
ALL SNOWMOBILES



**CALIBER®
RAMP PRO 2.0**

- 52" wide and 90" long
- New, improved 2.0 design features
- 12" wide glides accommodating narrow RMK ski stances
- 1,500lb rating

2884576 ★ TOP SELLER



SELF-RETRACTING STRAP INCLUDED

ULTIMATE TRACTION AND GLIDE



INTEGRATED FINGERS



INTEGRATED FEET



**CALIBER
LOWPRO GRIP GLIDES**

- Extension (4st 76 cm) | **2882981**
- Single set (8st 76 cm) | **2882982**
- Double set (16st 76 cm) | **2882983**

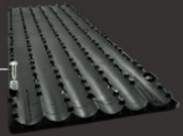

**CALIBER
TRAX GRABBER**

The TraxGrabber designed for maximum traction with minimal height obstruction and weight for Trailer doors. Strategic Lug placement in Trax Grabber optimize traction by providing interlocking with 2.52, 2.86 and 3.0 pitched tracks, simultaneously. The most innovative traction option on the market.

Trax Grabber (2st/Kit) | **2882998**



CALIBER SLED WHEELS

- Large 5" wheels for easy steering/rolling
- Move your sled around the garage with ease

Red | **2883852** ★ TOP SELLER
Gray | **2883853**
ALL SNOWMOBILES



FRONT CLAMP

- Adjustable to fit all snowmobiles
- Rubber silicone pads protect and secure skis
- Integrates to all trailers
- Includes deck hook

2882961
ALL SNOWMOBILES

REAR CLAMP

- Composite construction with silicone rubber padding
- Tension adjustment knob to fit all snowmobiles
- Secures via rear suspension skid
- 12" Supertrac Kit included

2882962



SUPERCLAMP® DECK HOOKS
2882963



SUPERCLAMP® TRAC HOOK
2882965

SUPERCLAMP® TRAC
2882964

TRACTION & CONTROL

RIP WITH AN IRON GRIP.

Whether you're replacing your carbides or looking to add more traction and control for enhanced safety and performance, premium Woody's stud kits and carbide runners are exclusively engineered for your Polaris snowmobile.

CONTROL FOR HOW YOU RIDE

STUDS

Choose the right length stud for your track lug and then select a pattern to best suit your riding style for a touch of added control to monster holeshots.

TUNNEL PROTECTION

Required protection for when you stud, these "wear strips" protect your tunnel and vital cooling components from damage.

CARBIDES

Replacing or upgrading, add the right amount of ski control to match your track length, studding pattern and riding style.

STUD KITS



Includes everything to update your sled's traction—studs, nuts, backer plates, template and track drill bit.

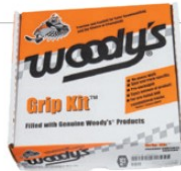

FITMENT YEAR	SLED MODEL/TRACK	TRACK LENGTH	LUG HEIGHT	PITCH	STUD QUANTITY	STUD KIT
MY15-MY20	RUSH/Cobra/RipSaw 2	120	1.352"/1.25"	2.86	84	2884197
MY15-MY20	RUSH/Storm 150	120	1.5"	2.86	84	2883675
MY17-MY19	RUSH XCR/Cobra	121	1.352"	2.52	96	2884198
MY19-MY20	INDY 129/Cobra/RipSaw 2	129	1.352"/1.25"	2.86	90	2884199
MY19-MY20	INDY 129/Storm 150	129	1.5"	2.86	90	2883677
MY20	INDY XCR/Cobra	128	1.352"	2.52	102	2884302
MY15-MY20	SWITCHBACK 137/Cobra/RipSaw 2	137	1.352"/1.25"	2.86	96	2884200
MY15-MY20	SWITCHBACK 137/Storm 150	137	1.5"	2.86	96	2883679
MY18-MY20	SWITCHBACK XCR/Cobra	136	1.352"	2.52	108	2884201
MY20	INDY 137/Cobra/RipSaw 2	137	1.352"/1.25"	2.86	96	2884200
MY20	INDY 137/Storm 150	137	1.5"	2.86	96	2883679
MY17-MY20	SWITCHBACK ASSAULT/Cobra	144	1.352"	2.52	114	2884202
MY17-MY20	INDY 550 144 / Cobra	144	1.352"	2.52	114	2884202
MY18-MY20	TITAN/Ripsaw	155	1.375"	2.86	108	2884203
MY18-MY20	TITAN/Cobra	155	1.5"	2.86	108	2884204
MY21	MATRYX 129/Cobra/Ice Ripper	129	1.352"/1.25"	2.86	90	2884199
MY21	MATRYX 129/Storm 150	129	1.5"	2.86	90	2883677
MY21	MATRYX 137/Cobra/Ice Ripper	137	1.352"/1.25"	2.86	96	2884200
MY21	MATRYX 137/Storm 150	137	1.5"	2.86	96	2883679
MY21	MATRYX 146/Cobra 1.3	146	1.352"/1.25"	2.86	102	2884985
MY21	MATRYX 146/Storm 150/Cobra 1.6	146	1.5"/1.6"	2.86	102	2884986

TUNNEL PROTECTION SOLD SEPARATELY

TUNNEL PROTECTOR
Not Required
Not Required
Not Required
2883572
2883572
2883572
Not Required
Not Required
Not Required
2884301
2884301
2881605
2879831
2882880
2882880
2884961
2884961
2884962
2884962
2884963
2884963



TUNNEL PROTECTION

SLED MODEL	FITMENT YEAR	PART NUMBER
INDY XC 129/INDY XCR ★ TOP SELLER	MY19-MY21	2883572
TITAN	MY18-MY21	2882880
SWITCHBACK ASSAULT	MY17-MY21	2884730
SWITCHBACK ASSAULT	MY11-MY16	2878161
550 INDY 144/VOYAGEUR	MY11-MY21	2879831
550 INDY 121	MY11-MY21	2879830
600/800 INDY 121	MY13-MY15	2879212
INDY XC 137/INDY ADVENTURE 137	MY20-MY21	2884301
INDY EVO	MY19-MY21	2879830
MATRYX 129	MY21	2884961
MATRYX 137	MY21	2884962
MATRYX 146	MY21	2884963

CARBIDE WEAR STRIPS

Carbides need to be sharpened or replaced periodically due to normal wear and use. Rocks, cement, pavement and road crossings all contribute to carbide wear.

3"-4" CARBIDE



- Perfect for sleds with a 121" track with 96 studs or less or sleds with 1" lugs taking corners at moderate speeds

6" CARBIDE



- Ideal for sleds in the 136" track range with up to 1 1/4" lugs or shorter track sleds with more than 96 studs

8" CARBIDE

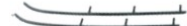

- Best for ultimate-performance sleds with a 144" track or longer with paddles and/or the maximum amount of studs

CHOOSE YOUR LENGTH

SINGLE RUNNER

Provides known reliability, handling and control.

SKI	NOTE	3"	4"	6"	6"	8"	8"
Pro-Steer/Pro-Float	Sold Individually		2879025 ★ TOP SELLER			2879026	2879027
Gripper	Sold Individually	2875723 ★ TOP SELLER		2877880		2877881	

DOUBLE RUNNER

Provides an increase in steering control in icy conditions and minimizes darting when riding on packed trails. Perfect to pair with a studded track.

SKI	NOTE	SLIM JIM		DOOLY	
		4"	6"	4"	6"
Pro-Steer/Pro-Float/Gripper	Sold Individually	2882956	2882957	2882953	2882954



BITEHARDER® CARBIDE SHARPENER

- Designed to be used with portable drill for sharpening anywhere
- Carbide wear-bar sharpening tool for use on the trail or in the shop
- Quickly and easily puts a fresh edge on wear bars for improved handling
- Delivers more precise and accurate handling, especially in the corners
- Features a long-lasting, V-shaped, diamond-coated sharpening stone
- Long-lasting diamond media can sharpen up to 40 wear bars

2882952

ALL SNOWMOBILES

★ TOP SELLER

ICE SCRATCHERS



- Direct ice chips into skid to lube and cool hi-fax
- Permits wheel removal on SKS 155, saving 4 lbs

2882028

ALL AXYS PRO-RMK, ASSAULT RMK, SKS 155

2876256

PRO-RIDE RMK, RMK ASSAULT

RMK BOGIE WHEEL KIT



- Wheels install on stock skid
- Reduces hi-fax wear on hard-pack snow and ice
- A total of three pairs can be installed onto a stock skid

2882048

ALL AXYS PRO-RMK. COMES STANDARD ON SKS 155.

2878251

PRO-RIDE



XCR TORSION BAR KIT

- Reduces body roll when cornering

2881950

MY15-20 RUSH 6 MY15-21 AXYS SWITCHBACK

FOUR KEYS TO TRACK SELECTION

LENGTH

The inside circumference of the track is calculated as the drive pitch multiplied by the number of track segments. It must be correct to the nearest inch for proper fit without additional modifications to the skid frame.



DRIVE PITCH

The drive cog center distance around the circumference of the cogs on the drive axle. It must match the existing track or the drive cogs must be changed.

- 2.52" drive pitch primarily machines manufactured before 2007
- 2.86" drive pitch especially on recent models manufactured after 2007
- 3" and new 3.5" drive pitch for lowest weight on select mountain sleds

WIDTH

The measurement across the track governed by the width of the tunnel.

LUG HEIGHT

The distance lugs extend above the track surface.

- Trail: 1" - <1.5"
- On/Off Trail: 1.5" - <2"
- Deep Snow: 2" and greater

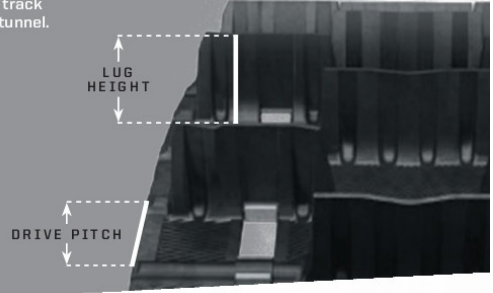

TRAIL



ICE STORM 150



- Two-height lug design offers deep-snow flotation with handlebar-gripping acceleration
- Factory-pre-studded for improved traction and control on icy conditions
- 1.25" outer lugs and 1.5" cup-shaped center lugs provide power and traction on packed trails and turns

LENGTH	PITCH	LUG HEIGHT	
120"	2.86"	1.25"	2839388
129"	2.86"	1.25"	2839389
137"	2.86"	1.25"	2839390
146"	2.86"	1.25"	2839391



HURRICANE



- Designed based on mountain tracks, it provides off-trail performance in deep snow while maintaining on-trail agility
- 1.75" cupped profile design provides unparalleled grip in the backcountry
- 1.75" tall lug profile design reduces vibration, applying more power to the ground

LENGTH	PITCH	LUG HEIGHT	
120"	2.86"	1.75"	2839400
129"	2.86"	1.75"	2839401
137"	2.86"	1.75"	2839402
146"	2.86"	1.75"	2839403



COBRA



- Cupped lugs for superior acceleration and braking in loose, soft-snow conditions
- Flexible lug design for superior off-trail performance

LENGTH	PITCH	LUG HEIGHT	
120"	2.86"	1.352"	2839284
121"	2.52"	1.352"	2839052
129"	2.86"	1.352"	2839235
136"	2.52"	1.352"	2839061
137"	2.86"	1.352"	2839307
137"	2.86"	1.352"	5413661
144"	2.52"	1.352"	2839107
144"	2.86"	2.52"	5414013
144"	2.86"	1.6"	5416162
155"	2.86"	1.5"	5415826
155"	2.86"	1.8"	5416020

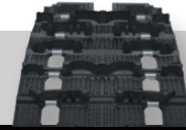

STORM 150



- 1.25" outer lugs provide power through the tightest turns with ease, maintaining momentum and rider control
- 1.5" cup-shaped center lugs provide deep snow flotation and gut-wrenching acceleration on packed trails
- Optimized support columns provide the right balance of lug rigidity and flex for performance across the entire power band

LENGTH	PITCH	LUG HEIGHT	
120"	2.86"	1.25"/1.5"	2839368
129"	2.86"	1.25"/1.5"	2839369
137"	2.86"	1.25"/1.5"	2839370
146"	2.86"	1.25"/1.5"	2839371

MOUNTAIN



SERIES 7



- Polaris exclusive
- Ideal track to provide lift in the deepest, softest snow conditions
- Features a new lightweight single-ply design optimized for weight and powder snow performance

LENGTH	PITCH	LUG HEIGHT	
155"	3"	3"	5415393
163"	3"	3"	5415394
174"	3"	3"	5415786



SERIES 6



- Outstanding traction and control in deep snow
- Lugs provide tremendous flotation and great performance
- 2.6" lugs provide outstanding traction in all deep-snow conditions
- Design provides outstanding flotation and control

LENGTH	PITCH	LUG HEIGHT	
155"	2.86"	2.6"	5415391

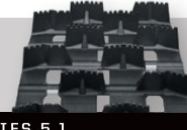

SERIES 5.1



- Industry-leading deep-powder track; for 8T drive sprockets, 2.86" pitch
- Optimized lug pattern producing 19% more forward lug contact compared to our Series 5.0 track
- Soft and flexible tips for superior performance in deep snow

LENGTH	PITCH	LUG HEIGHT	
155"	2.86"	2.4"	5413622
163"	2.86"	2.4"	5413621



PEAK 2.25



- Angular lugs bite and funnel snow under the snowmobile for outstanding flotation
- Features soft lugs for powder snow and hard lugs for heavy/wet snow
- Outer lug bars deliver better lateral control for improved handling

LENGTH	PITCH	LUG HEIGHT	
155"	2.86"	2.25"	5415002

CROSSOVER

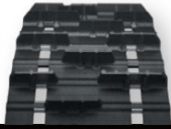

BACKCOUNTRY

ON TRAIL OFF TRAIL

- Arched lug design with staggered, snocross-inspired pattern for excellent soft-snow traction

LENGTH	PITCH	LUG HEIGHT	
120"	2.86"	1.75"	5414884
121"	2.52"	1.75"	2839140
121"	2.52"	1.75"	5415097
136"	2.52"	1.75"	2839142
136"	2.52"	1.75"	5414878
137"	2.86"	1.75"	5414895
144"	2.52"	1.75"	2839143
144"	2.52"	1.75"	5415096

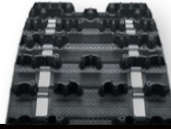

COBRA 1.6

ON TRAIL OFF TRAIL

- Cupped lugs for superior acceleration and braking in loose, soft-snow conditions
- Flexible lug design for superior off-trail performance
- Select lugs are more rigid for traction on hard-packed snow

LENGTH	PITCH	LUG HEIGHT	
129"	2.86"	1.6"	2839292
137"	2.86"	1.6"	2839264
155"	2.86"	1.6"	5414902

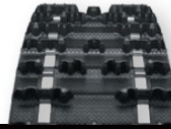

ICE COBRA 1.6

ON TRAIL OFF TRAIL

- Cupped lugs for superior acceleration and braking in loose, soft-snow conditions
- Flexible lug design for superior off-trail performance
- Factory-pre-studded with 1.6" lugs for excellent all-round performance, especially on ungroomed trails

LENGTH	PITCH	LUG HEIGHT	
120"	2.86"	1.6"	2839244
137"	2.86"	1.6"	2839246
155"	2.86"	1.6"	2839273



CHALLENGER

ON TRAIL OFF TRAIL

LENGTH	PITCH	LUG HEIGHT	
136"	2.52"	2"	2839797
137"	2.86"	2"	2839186
144"	2.52"	2"	2839875
146"	2.86"	2.5"	2839145
151"	2.52"	2"	2839876
153"	3"	2.5"	2839174
154"	2.86"	2.5"	2839104
156"	3"	3.2"	2839320
162"	3"	3.2"	2839175
162"	3"	2.5"	2839319
163"	2.86"	2.5"	2839105



ICE ATTAK XT

ON TRAIL OFF TRAIL

- Factory-pre-studded for improved traction and control
- Designed to provide even better ice performance than the ICE Ripper XT
- 1.22" lug height provides better handling and stability
- Optimized rubber compound for superior traction on groomed trail

LENGTH	PITCH	LUG HEIGHT	
120"	2.86"	1.22"	2839190
121"	2.52"	1.22"	2839200
128"	2.52"	1.22"	2839201
129"	2.86"	1.22"	2839236
136"	2.86"	1.22"	2839202
137"	2.86"	1.22"	2839191
144"	2.52"	1.22"	2839203



RIPSAW

ON TRAIL OFF TRAIL

- Rigid lugs provide superior handling, acceleration and braking on groomed trails
- Narrow lug base for reduced rolling resistance and maximum top speed
- Angled profiles for aggressive forward and lateral bite

LENGTH	PITCH	LUG HEIGHT	
120"	2.86"	1.25"	2839149
121"	2.52"	1.25"	2839146
121"	2.52"	1.25"	2839968
128"	2.52"	1"	2839234
128"	2.52"	1.25"	2839001
128"	2.52"	1.25"	2839215
136"	2.52"	1.25"	2839969
136"	2.52"	1.5"	5413543
155"	2.86"	1.375"	5416227



RIPSAW 2

ON TRAIL OFF TRAIL

- Tapered outside lug edges for less side bite when cornering
- Sharp angled lugs for excellent bite on hard-pack snow
- Cupped center and full outer lugs for traction on loose, less-compacted snow

LENGTH	PITCH	LUG HEIGHT	
120"	2.86"	1.25"	2839209
120"	2.86"	1.5"	2839304
120"	2.86"	1.25"	5414653
121"	2.52"	1.25"	2839214
129"	2.86"	1.5"	2839305
136"	2.52"	1.25"	2839216
137"	2.86"	1.25"	2839223
137"	2.86"	1.5"	2839306
137"	2.86"	1.25"	5414654



CONQUER 280

ON TRAIL OFF TRAIL

- Lightweight construction
- 2.8" alternating single-angled lugs push performance in all-season riding conditions

LENGTH	PITCH	LUG HEIGHT	
153"	3"	2.8"	2839337
156"	3"	2.8"	2839336
162"	3"	2.8"	2839335
174"	3"	2.8"	2839334



SERIES 5.2

ON TRAIL OFF TRAIL

- Modeled after the modified Series 5.1 track used by Polaris hillclimb racers
- Provides great traction both on- and off-trail
- Maintains excellent durability
- Optimized lug pattern for more forward lug contact

LENGTH	PITCH	LUG HEIGHT	
146"	2.86"	2.25"	5416498



SERIES 4

ON TRAIL OFF TRAIL

- The standard in 2" deep-snow tracks; for 9T drive sprockets, 2.52" pitch
- Equal parts versatility and durability
- Stiff lug base for long wear and hard-pack performance
- Soft and flexible tips for superior performance in deep snow

LENGTH	PITCH	LUG HEIGHT	
144"	2.52"	2"	5413073
144"	2.52"	2"	5415692

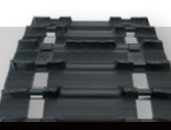

SHOCK WAVE

ON TRAIL OFF TRAIL

- Designed for hard-working, utility applications
- Able to handle heavy workloads in deep-snow, off-trail environments
- Tackles on-trail and hard-packed applications
- 1" lug height with 2.52" pitch

LENGTH	PITCH	LUG HEIGHT	
156"	2.52"	1"	5414453

SEE ALL TRACKS OPTIONS AT POLARIS.COM/TRACKS

COMPETITION TRACK

ON TRAIL OFF TRAIL

- Customized for snocross competition
- Developed for and tested by top Polaris racers

LENGTH	PITCH	LUG HEIGHT	
155"	2.86"	2.1"	2877304

YOUTH 120

ON TRAIL OFF TRAIL

- Replacement track for the Polaris 120 INDY

LENGTH	PITCH	LUG HEIGHT	
68"	2.55"	.71"	5411751

MATRIX, LOOK 6 RIDE FLEX

STORAGE RACKS 6 HITCHES

SEATING 6 WINDSHIELDS

BUMPERS, SKID PLATES 6 RUNNING BOARDS

SXS SPOCKS 6 KITS

HANDLEBARS 6 ELECTRONICS

ROCK COMMAND 6 P.I.D.O.

COVERS 6 TRAILERING

STOPS STRIPS 6 TRACKS



BELTS
pg 89



OIL
pg 86

MAINTENANCE
pg 84

GARAGE

FACTORY - APPROVED .

Every Polaris snowmobile has been engineered and manufactured to deliver performance. Keep it that way by using the same lubricants, cleaners and service parts our factory-trained technicians use.



MAINTENANCE

DRIVE BELTS

Only genuine Polaris Engineered Drive Belts provide a fit and optimum compound for maximum performance and reliability.

BREAK-IN PERIOD

The break-in period for a new belt is 50 miles. During this time, vary at moderate speeds while avoiding wide-open throttle.



EXIDE BATTERY CHARGER 220V

Battery charger EXIDE, for LEAD/ AGM 12V Batteries 4Ah to 150Ah.

E261910
EXIDE BATTERY CHARGER 12V-4A,
FITS BATTERIES UP TO 85AH

E261920
EXIDE BATTERY CHARGER 12V-7A,
FITS BATTERIES UP TO 150AH

SPARK PLUGS

New spark plugs engineered specifically for your Polaris snowmobile ensure quick starts, fuel efficiency and peak performance.

BATTERIES

Cold weather, harsh conditions and time can degrade a battery. A genuine Polaris replacement ensures an exacting fit and starting performance.

CARBIDES

Replace worn carbides or enhance your sled's handling with engineered exact fit wear bars with your choice of high-wear carbide length.

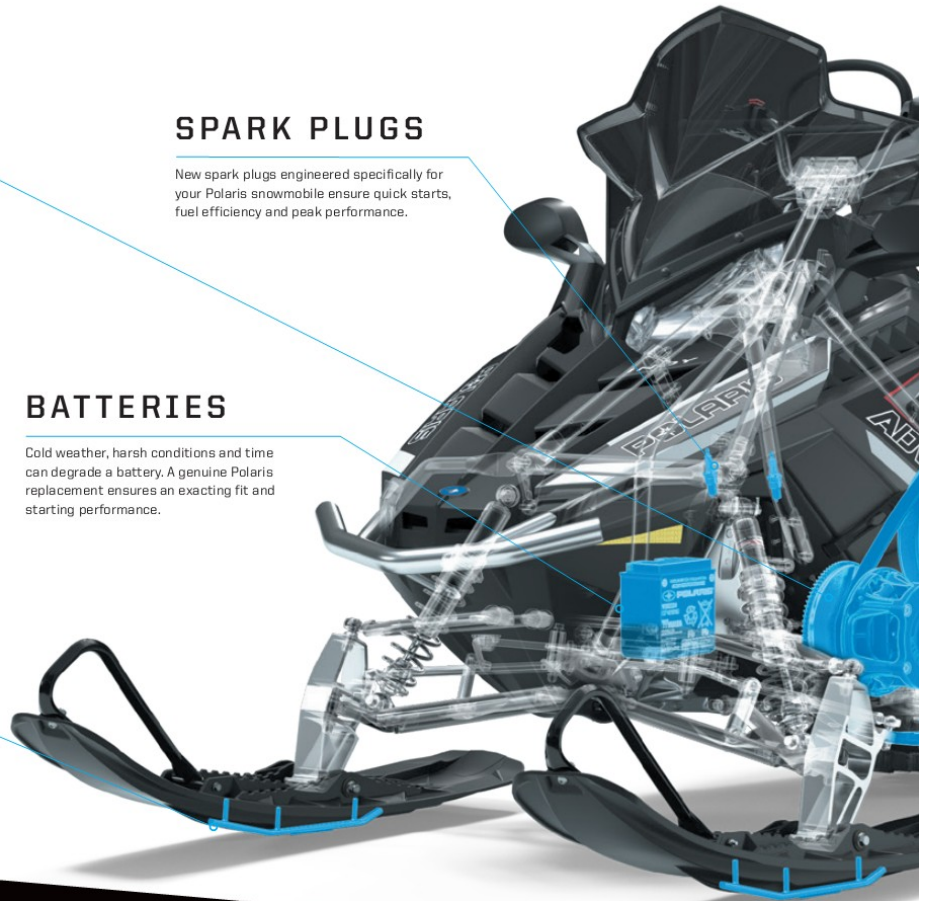

FOR THE LIFE OF YOUR RIDE.

We do more than build the world's greatest snowmobiles. We also work tirelessly to ensure the maintenance products you need are engineered to the same demanding standards. When it comes to drive belts, lubricants, batteries and more, we invest the time to make sure they're right, so you can spend more time riding.

**SEE OUR LATEST MAINTENANCE TIPS
AT [POLARIS.COM/MAINTENANCE-VIDEOS](https://www.polaris.com/maintenance-videos)**





TRACKS

Enhance traction and control or replace a worn track with the latest trend in track pitch, length, lug height and patterns.

STUDS

Enhance your snowmobile's traction, control and performance with premium studs designed for your sled, track and riding style.

RAIL SLIDERS

Replace worn hyfax with genuine Polaris rail sliders for a perfect fit and engineered compound for optimum performance.

MAINTENANCE



BATTERIES
YTX20CH Yuasa | 4013045
ETX20 Exide | E04999



SPARK PLUGS
Engineered for your Polaris sled
NGK | 3022082
Champion | 3070190

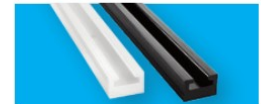

SLIDERS
5521632 5521633-309
5521633-070 5522144-070

MAINTENANCE SCHEDULE

CHECK YOUR OWNER'S MANUAL FOR ADDITIONAL RECOMMENDED SERVICE ITEMS AND VEHICLE-SPECIFIC TIMING

PRE-SEASON

ENGINE OIL:
FILL TO RECOMMENDED LEVEL

GENERAL LUBRICATION:
ALL FITTINGS, PIVOTS, CABLES, ETC.

CHECK FOR WEAR:
TEST, CLEAN & CHECK FLUID LEVELS
SPARK PLUGS, TRACK, SLIDER, DRIVE BELT & CARBIDES

500mi (800km)

IN-SEASON

ENGINE OIL:
FILL TO RECOMMENDED LEVEL

DRIVE BELT:
INSPECT & ADJUST
FOLLOW BREAK-IN PROCEDURE AFTER INSTALLATION

TRANSMISSION FLUID:
CHANGE

2,000mi (3,200km)

IN-SEASON

ENGINE OIL:
FILL TO RECOMMENDED LEVEL

CHECK FOR WEAR:
TEST, CLEAN & CHECK FLUID LEVELS
SPARK PLUGS, TRACK, SLIDER, DRIVE BELT & CARBIDES

DRIVE BELT:
INSPECT & ADJUST
REPLACE AS NEEDED

END OF SEASON

DRIVE BELT:
REMOVE
CONSULT OWNER'S MANUAL

FUEL:
ADD FUEL STABILIZER

TRACK:
INSPECT
REDUCE TENSION DURING STORAGE

BATTERY:
REMOVE



IRON DOG
THE WORLD'S LONGEST TOUGHEST SNOWMOBILE RACE

OIL FOR EVERY SLED, PROVEN IN THE TOUGHEST RACE.

When you're flying across 3,219 kilometers of Alaskan tundra, racing riders and the bitter winter wind to seize your immortal moment, you need equipment you can count on. Iron Dog® snowmobile riders count on Polaris Engineered Oils & Lubricants™ to withstand sub-zero temperatures, mountain ranges, and rock hard wind drifts at high speed over a grueling 35 hours.

They know Polaris® Engineers rigorously test every fluid before it earns the Polaris Engineered Lubricants™ badge and a spot on the shelf. So inside and out, their sled will be just as strong as their will to win. Whether you're racing across the Alaskan wilderness or just casually riding on a trail, you can be confident there's no better oil for your sled than Polaris Engineered Oils & Lubricants™.

VES

Low-odor, low-smoke oil formulation designed to improve exhaust valve performance. VES offers maximum engine protection.

OUR FORMULATION

- Synthetic Performance formula
- Proprietary anti-wear, corrosion and detergency additive package
- Retains film on critical engine parts after hot shutdown

YOUR ADVANTAGE

- Engineering approved for use across all snow engine platforms
- Cleaner burning resulting in extended life of cylinders, pistons, rings & bearings
- Protects engine during periods of non-use or storage
- Reduces pull effort by leaving components lubricated

VES EXTREME

Engineered, formulated and tested to easily handle the high demands of today's high-performance Polaris® snowmobile engines.

OUR FORMULATION

- Full synthetic, 100% PAO and Ester formula
- Highest engine film strength and lubricity protection
- Optimized mixture of heavy and light viscosity base oils and solvents
- Proprietary anti-wear, corrosion and detergency additive package

YOUR ADVANTAGE

- Best engine wear protection available for 2-cycle snowmobile engines on the market
- Maintains like-new HP performance throughout engine lifecycle
- Enhanced oil to ensure pins, bearings and all metal-on-metal components are protected
- Highest detergency available for ring lands, undercrown and exhaust valves

1L
502493

25L
502515

204L
502517

4L
502514

60L
502516

4L
502691
VES EXTREME, ONLY
AVAILABLE IN 4 LITERS

OIL DEVELOPMENT

POLARIS INVESTS IN EACH OIL AT AND ABOVE THESE LEVELS.
POLARIS.COM

12 DEDICATED
TEAM MEMBERS

FOCUSED ON
POLARIS OIL

18+
MONTHS

DEVELOPMENT
& TESTING

POLARIS®

ENGINEERED LUBRICANTS

FOR THE LIFE OF YOUR RIDE, ONLY THE BEST WILL DO.

In the continued pursuit of creating the best oil on snow, we invest in rigorous testing to ensure our oil delivers unrivaled consistency and performance. The result are Polaris Engineered Lubricants™ that are tested and perfected to deliver excellent total engine protection for the life of your ride.

Oil and cleaners featured are for EU distribution only. For other availability, contact your local dealer.

“WE TRUST POLARIS VES OIL IN THE EXTREME 2,000 MILE (3,219 KM) IRON DOG EVENT BECAUSE AMONG ALL THE ISSUES WE FACE, IT'S ONE LESS THING WE HAVE TO WORRY ABOUT.

— MIKE MORGAN, IRON DOG RACER

POLARIS® BLUE

Synthetic Blend engine oil specially formulated for excellent protection and performance in all 2-cycle injector or pre-mix non-VES applications.

OUR FORMULATION

- Synthetic Blend formula
- High lubricity
- Proprietary corrosion additive package

YOUR ADVANTAGE

- Excellent cold flow for easier starting down to -70° F (-40° C)
- Prevents rust and corrosion, ring sticking and plug fouling
- Lower total cost of ownership including extending the life of the engine

1 L
502571
4 L
502495

25 L
502501
60 L
502503

200 L
502504

1000+
HOURS

DYNO TESTING

64,374
KILOMETERS

FIELD TESTING

WHAT COUNTS IN OIL TESTING:

1. Does it protect the engine at low temperatures?
2. Does it protect the engine from high heat wear?
3. Does it keep the engine clean?

PISTON CHECKPOINTS

PISTON DOME: Is it clean? Clean burning oil and our proprietary detergency system prevents carbon buildup and hot spots, which extends piston life and maintains optimal run quality.

PISTON RINGS AND RING LANDS: Are they free of carbon deposits and soot? This is important to preserve ring seal and maximum power output.

PISTON PINS AND NEEDLE BEARINGS: Proper viscosity and lubricity, film strength and our proprietary additives provide exceptional protection and heat control, maintaining proper pin and bearing tolerances and performance.

PISTON SKIRT: Is the Grafal coating scratched or visibly damaged? Harsh contact between the cylinder and piston due to insufficient lubrication would eventually result in engine failure.

ENGINEERED TO MAXIMIZE THE LIFE OF YOUR RIDE

All Polaris® fluids—from anti-freeze to brake fluid—are developed for your vehicle. Trust the only fluids perfectly engineered for your needs.



CARBON CLEAN

Polaris® Carbon Clean prevents ethanol corrosion, stabilizes fuel, and cleans carburetor jets and fuel injector nozzles, deposits on piston and rings, intake systems, and combustion chambers. Antioxidants preserve fuel and prevent fuel system gumming.

125 ml | 502528



SYNTHETIC CHAINCASE LUBE

Unlike typical gear case oils, SCL's unique viscosity range allows instant flow and film protection in extreme cold or high heat environments.

1 L | 502560
25 L | 502561
201 L | 502562



ANTI-FREEZE

Polaris® Extended Life Anti-Freeze contains organic acid technologies to prevent corrosion on metal components, eliminate scaling, and maximize cooling system performance.

1 L | 502566
25 L | 502567
206 L | 502568



SHOCK OIL

1 L | 502518



FUEL STABILIZER

- Advanced Fuel Treatment prevents ethanol corrosion and stabilizes fuel for up to 2 years. Dual-antioxidant formula protects against gum and varnish for easy starting

125 ml | 502519



DOT 4 BRAKE FLUID

Polaris® DOT 4 Brake Fluid is designed for use in Polaris® hydraulic brakes. Superior high-temp characteristics plus anti-corrosion additives extend the life of brake system components.

250 ml | 502526



OIL

Polaris® Blue, VES, and VES Extreme 2-cycle oils are tested to perform, and are the only oils developed specifically for your Polaris® snowmobile engine. Exclusive anti-wear additives protect engine parts with extra rust and corrosion protection.

2-Cycle oils Part numbers. See previous page.



ALL-SEASON GREASE

Polaris® All-Season Grease is designed to maintain consistency across a wide range of temperatures. Engineered to protect front and rear suspension components, steering bushings, and driveline bearings.

400 gr | 502538
185 kg | 502539

CLEAN

ALL-PURPOSE CLEANER

- Professional grade, non-streak and biodegradable universal cleaner for the whole sled

500 ml | 502533



SHINE

INSTANT SHINE & DETAILER

- Quick and protective cleaning for a sparkling clean result. Polaris Instant Shine and Detailer does not need additional water! Ideal for plastics, glass, varnishes, metals as well as windshields and visors

500 ml | 502546



Oil and cleaners featured are for EU distribution only. For other availability, contact your local dealer.

POLARIS ENGINEERED DRIVE BELTS

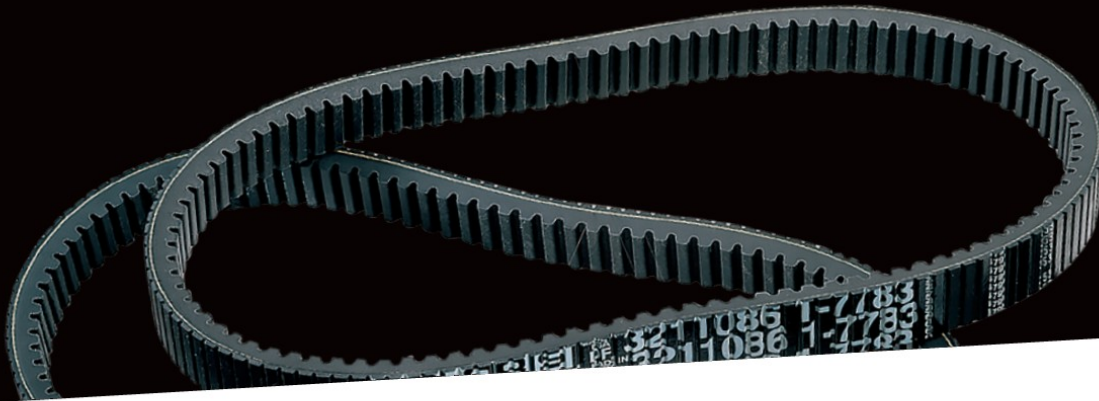

OUR INVESTMENT PER BELT

- 20,000 miles of field testing
- Thousands of dyno hours
- 18+ months of development (3,000+ design hours) per belt
- 1,200+ vehicle validation hours
- Collaboration with powertrain & clutch engineers

YOUR ADVANTAGE

- No clutch recalibration
- Less wear & tear due to heat
- Ensure maximum performance of your vehicle
- More time out riding, less time wrenching

BELT COMPOUND & CONSTRUCTION NOTES	BELT WIDTH*	OUTER CIRCUMFERENCE*	PART NO.
AXYS: <i>RUSH, SWITCHBACK, SWITCHBACK ADVENTURE, SWITCHBACK ASSAULT, VOYAGEUR TITAN, INDY 129 & INDY 137</i>			
HIGH MODULUS CHLOROPRENE BELT	1.46" (37.10MM)	45.16"	3211215 (MY20-later 800cc / All 850cc)
PBO BELT	1.46" (37.10MM)	45.16"	3211177 (800cc)
PBO BELT	1.46" (37.10MM)	45.16"	3211165 (600cc/650cc)
AXYS: <i>PRO-RMK, RMK ASSAULT, SKS & KHAOS RMK</i>			
HIGH MODULUS CHLOROPRENE BELT	1.46" (37.10MM)	46.77"	3211216 (MY20-later 800cc / All 850cc)
PBO BELT	1.46" (37.10MM)	46.77"	3211183 (800cc)
PBO BELT	1.46" (37.10MM)	46.77"	3211115 (600cc)
PRO-RIDE: <i>RUSH, SWITCHBACK, SWITCHBACK ASSAULT, INDY, VOYAGEUR, PRO-RMK, RMK, RMK ASSAULT</i>			
PBO BELT	1.46" (37.10MM)	46.77"	3211115
KEVLAR® BELT	1.46" (37.10MM)	46.77"	3211122
KEVLAR® BELT	1.32" (33.53MM)	43.23"	3211174 (550cc)
STANDARD BELT	1.29" (32.77MM)	42.48"	3211154 (550cc)
FIND THE RIGHT BELT FOR YOUR MACHINE IN OUR ONLINE PARTS CATALOG AT POLARIS.COM			

*Belt dimensions are given in nominal dimensions. There is a +/- variance for all critical dimensions. Clutch setup must be inspected when a new belt is installed and should be adjusted if necessary. The drive belt is an important component in the CVT system. In order to achieve maximum efficiency from the converter, drive-belt deflection (tension), clutch offset and alignment must be adjusted properly. See your Service Manual for further details on drive-belt measurement inspection.

GARAGE + BATTERIES



EXIDE BATTERY CHARGER 220V

Battery charger EXIDE, for LEAD/AGM 12V Batteries 4Ah to 150Ah.

E261910
EXIDE BATTERY CHARGER 12V-4A, FITS BATTERIES UP TO 85AH

E261920
EXIDE BATTERY CHARGER 12V-7A, FITS BATTERIES UP TO 150AH

TOWELS

POLARIS SHOP TOWELS

- 64 Count | 2830440
- 200 Count | 2830402
- 200 Count Refill | 2830403



POLARIS HEAVY-DUTY SCRUBBER WIPES

- 90 Count | 2830441



POLARIS X3 CREEPER

- Three positions: flat, 45-degree angle or seated work stool
- Helps you perform any repair with ease
- Stay dry and warm away from cold, wet concrete floors
- Easily stores away when not in use

Black | 2830429



SNOW DOLLY

- 3" big-wheel caster design
- Move your sled around the garage with ease

2882959



POLARIS MAGNETIC PARTS TRAY

Silver | 2830432



POLARIS 33" TELESCOPIC MAGNET

Black | 2830435



POLARIS 12" HI-TORQUE RATCHETING DRIVER

Black/Blue | 2830434



POLARIS LED POCKET FLASHLIGHT

Black | 2830436

SIZING GUIDE

MEN'S JACKET & BIB SIZING

SIZE	S	M	L	XL	2XL	3XL	4XL	5XL	MT	LT	XLT	2XLT
CHEST	34-36	38-40	42-44	46-48	50-52	54-56	58-60	62-64	38-40	42-44	46-48	50-52
SLEEVE*	33-35	33-35	34-35	34-35	34-35	34-35	34-35	34-35	33-35	34-35	34-35	34-35
WAIST	31-33	35-37	39-41	43-45	47-49	51-53	55-57	59-61	35-37	39-41	43-45	47-49
HIPS/SEAT	34-36	38-40	42-44	46-48	50-52	54-56	58-60	62-64	38-40	42-44	46-48	50-52
INSEAM	30-35	30-35	30-35	30-35	30-35	30-35	30-35	30-35	36-37	36-37	36-37	36-37

* Measure sleeve length from center back neck.

WOMEN'S JACKET & BIB SIZING

SIZE	S	M	L	XL	2XL	3XL
CHEST	32-34	35-38	39-42	43-46	47-50	51-54
SLEEVE*	29-30	31-33	31-33	31-33	31-33	31-33
WAIST	26-28	28-32	33-36	37-40	41-44	45-48
HIPS/SEAT	35-37	38-41	42-45	46-49	50-53	54-57
INSEAM	26-29	27-30	27-30	27-30	27-30	27-30

HELMET SIZING GUIDE

SIZE	XS	S	M	L	XL	2XL	3XL	4XL	5XL
SIZE CODE	00	02	03	06	09	12	14	15	16 F
HAT SIZE	6 3/4	6 7/8-7	7 1/8-7 1/4	7-7 1/8	7 3/4-7 3/4	7 7/8-8	8	8 1/4	8 1/2
CIRCUMFERENCE	20 7/8"-21 1/2" (53-54cm)	21 3/8"-22" (55-56cm)	22 1/8"-22 3/4" (57-58cm)	23 1/8"-23 3/4" (59-60cm)	24"-24 3/4" (61-62cm)	24 3/4"-25 1/2" (63-64cm)	25 1/2"-26" (65cm)	26 1/8"-26 3/4" (66cm)	27 1/8"-27 1/2" (69-79 cm)

APPAREL



FIDLOCK® MAGNETIC TECHNOLOGY

An easy-on and easy-off magnetic closure device that delivers a quick, secure helmet strap closure on select 509 helmets.



DOT & ECE 22.05 CERTIFIED

The Department of Transportation (DOT) standard is enforced by the National Highway Traffic Safety Administration (NHTSA.) For a helmet to be DOT-certified, it must pass a series of impact tests.

The Economic Commission for Europe (ECE) standard, R 22.05, is the most common helmet standard used internationally, as it is recognized by over 50 countries. To be ECE 22.05 certified, the helmet must pass a series of rigorous tests by an independent third-party lab.



TECH54

A waterproof and breathable membrane bonded to the shell fabric to block moisture from entering while allowing vapor moisture to escape from the inside.



SUPERIOR DURABLE WATER REPELLENCY (DWR)

A Superior DWR coating causes water to bead up and run off, preventing precipitation from saturating the exterior of an outerwear piece.



BOA® LACING SYSTEM

The BOA® lacing system is easier to get on and off than traditional lace-up boots. Simply push to engage, turn to tighten and pull for quick release.



3M® THINSULATE® INSULATION

3M® Thinsulate® Insulation is warm yet lightweight, powerful yet thin. It helps trap body heat while allowing moisture to escape.



3M® SCOTCHLITE® REFLECTIVE MATERIAL

Patented 3M® Scotchlite® Reflective Material provides nighttime visibility from every angle.



YKK® ZIPPERS

The YKK® Fastening Products Group is trusted worldwide for impeccable production standards and thorough quality control processes for slide fasteners, plastic hardware, hook-and-loop fasteners, webbing tapes and snap-and-button products.



MOUNTAIN APPAREL

Uninsulated outerwear made of TECH54 10k/10k material.



CROSSOVER APPAREL

Insulated outerwear made of TECH54 10k/10k material.



TRAIL APPAREL

Insulated outerwear made of TECH54 5k/5k material.

ACCESSORIES + GARAGE



LOCK & RIDE

For Snow Accessories, a T-Slot tunnel attachment system.



LOCK & RIDE FLEX

The fastest attachment system designed for tunnel-mounted Snow Accessories. Adapter kit sold separately to update a Lock & Ride attachment system to the Lock & Ride Flex system.



CAMSO®

Customer-focused, world-class manufacturer and supplier of high-performance snowmobile tracks.



BATTERYMINDER®

Ensure your ride is ready when you are and extend your battery life with BatteryMINDER® products.

MAKE IT YOUR OWN

- 1 CHOOSE MODEL
- 2 CHOOSE COLOR
- 3 CHOOSE OPTIONS
- 4 CHOOSE ACCESSORIES



VISIT POLARIS.COM/SNOW
TO SEE ALL YOUR OPTIONS & ACCESSORIES ON
YOUR NEW SNOWMOBILE FROM EVERY ANGLE!

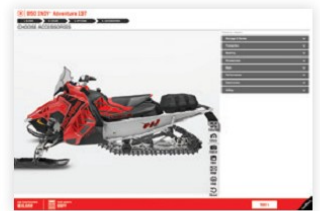
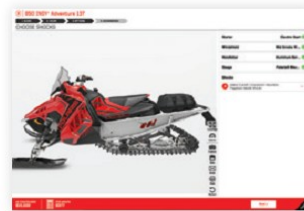
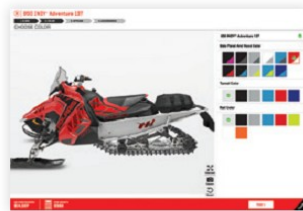

CONNECT ONLINE
SEARCH "POLARISSNOW"



POLARIS

MY21 SNOW P66A CATALOG-US • 9948023

FIND EVERYTHING YOU'RE LOOKING FOR AT **POLARIS.COM/SHOP**

Unless noted, trademarks are the property of Polaris Industries Inc. 3M® Reflective Material, Scotchlit® and Thinsulate® are registered trademarks of 3M Company. 509® is a registered trademark of Tet on Outfitters, LLC. ArcticFX® is a registered trademark of ArcticFX Graphics LLC. BatteryMINDER® is a registered trademark of VDC Electronics Inc. BITEHARDER® is a registered trademark of Welch Manufacturing Technologies, Ltd. Bluetooth® is a registered trademark of Bluetooth Sig, Inc. BDA® is a registered trademark of Boa Technology, Inc. Caliber® is a registered trademark of Caliber, Inc. CAMSO® is a registered trademark of Artic Investments S.A. DRY-LEX® is a registered trademark of Faytex Corp. Fidlock® is a registered trademark of Fidlock GmbH. FOX® is a registered trademark of Fox Factory Inc. GRAVAL® is a registered trademark of MAHLE GmbH. Ice Lock® is a registered trademark of TrekStix, Inc. Kevlar® is a registered trademark of E.I. du Pont de Nemours & Company. OGIO® is a registered trademark of Ogio International, Inc. PIEPS® is a registered trademark of Black Diamond Equipment, Ltd. Pro Taper® is a registered trademark of Lacy Distribution, Inc. Rox Speed FX® is a registered trademark of Rox Speed FX Inc. Snobunje® is a registered trademark of Snobunje, Inc. SUPERCLAMP® is registered to JPW Industries Inc. Tekvest® is a registered trademark of Tekrider. Tufflok® is a registered trademark of Illinois Tool Works Inc. Velcro® is a registered trademark of Velcro Industries B.V. Ltd Co. Netherlands. Walker Evans® is a registered trademark of Walker Evans Enterprises Corp. Woody® is a registered trademark of International Engineering & Manufacturing Inc. YKK® is a registered trademark of YKK Corporation. Zylex® is a registered trademark of Genfoot, Inc. All worldwide rights reserved. Other trademarks used in this catalog owned by their respective owners. Prices, fitment and availabilities are subject to change at any moment. © 2020 Polaris Industries, Inc.