



2023

**SNOWMOBILES, APPAREL,
ACCESSORIES & GARAGE**

POLARIS

SCANDINAVIA VERSION



POLARIS

THE ORIGINAL SNOWMOBILE CO

When you're on the snow, there are no boundaries, only possibilities. Every flake, every ride—originality in all its glory. Creating a boundless canvas for your signature sledding style. A blank page on which to pen fresh stories and put forth traditions that endure for generations. Snow. Wherever it lands, that's our true north—pure and simple. So, make it rip, make it float, make it fly, make it climb, make it wild, make it count, make it your own. Because winter is short and memory is long. And while there are easier ways to live, on snow we thrive and have since 1954.



RMK

WORLD'S BEST
MOUNTAIN SLED.
PGS. 8-13



INDY

LEGENDARY TRAIL
PERFORMANCE.
PGS. 14-19



SWITCHBACK

THE ULTIMATE
50/50 CROSSOVER.
PGS. 20-23



SNOWMOBILES

RMK	8
Indy	14
Switchback	20
Titan	24
Nordic Pro	28
Engines	32

APPAREL

TECH54	36
Men's Apparel	40
Women's Apparel	56
Youth Apparel	62
Helmets	66
Goggles	72
Gloves	74
Boots & Balaclavas & Luggage	76
Home & Collectibles	78

ACCESSORIES

Lock & Ride Flex	82
Connected Technology	84
MATRYX	86
AXYS	96
PRO-RIDE	112
Ride Readiness	118
Customization	120
Covers	122
Transport	124
Traction & Control	126
Tracks	128

GARAGE

Maintenance	132
Oil	136
Lubricants & Garage Accessories	140
Belts, HD Parts & Battery Chargers	142
Service Parts	144

TITAN

FUN NEVER
WORKED SO HARD.
PGS. 24-27

NORDIC PRO

WORK HARD.
HAVE FUN. REPEAT.
PGS. 28-31

2023

POLARIS
FAMILY OF
SNOWMOBILES



**WHEN WE SAY WE HAVE
THE BEST RIDERS IN THE SPORT...**

WE MEAN IT.

Polaris Snowmobiles are about more. More time spent exploring. More riding firsts. More thrilling moments. More connection and more appreciation for the escape you can only experience on the snow. We design the best sleds, built by the best team, ridden by the best riders and delivered through the best experiences—so that more control and confidence lives in every ride.



TEAM POLARIS ATHLETES

Technical, experienced riders that train and ride all year long. For these athletes, snowmobiling is more than a hobby. It's a way of life.

POLARIS RACERS

Heart pounding, full throttle, pushing the limits each race. From hillclimb to watercross, cross country to snocross... the best ride Polaris.

POLARIS AMBASSADORS

These snow-obsessed riders are driven to share their enthusiasm and knowledge for the sport of snowmobiling. We're glad to have them.

AND OF COURSE, YOU.

Whether you're a trail rider, king of the mountain, backcountry explorer, up and comer or new to the sport - welcome to the Polaris family.



2023 SNOWCHECK

With the best *Snowcheck ever, we proudly present the Snowmobile New's of model year 2023!
(With reservations of variations in dealers assortment and availability in season.)

So, what does Snowcheck mean to you who are not familiar with the term? Snowcheck is Polaris' half year pre-order system where you can build your Snowmobile exactly as you want it. Build the sled from your head. With the choice of engine, color, track, shocks, length, handlebars, displays, etc.

On the website you will find the build tool that makes it possible for you to play around, dream and share your perfect design with your friends, maybe preparing your order for next year's Snowcheck or rebuild the sled you ordered already.

Note! The Snowcheck period for model year 2023 ended March 24, 2022!

Contact your Polaris dealer for available models in season.

You are more than welcome to find the right accessories to your sled,
your use and you! Starting at page 80)



POLARIS | SNOWMOBILES

POLARIS 2023 NEWS



PROSTAR 4-STROKE!

PROSTAR S4 The all-new ProStar S4 delivers easy ownership and spirited performance, based on the proven ProStar engine architecture.



PROSTAR S4 TITAN ADVENTURE 155

PROSTAR S4 NORDIC PRO 146

PROVEN ARCHITECTURE The new ProStar S4 is based on the proven 4-stroke ProStar architecture that powers millions of Polaris off road vehicles.

EASY OWNERSHIP Cover more miles and get more done this winter with long range and easy service intervals.

SPIRITED PERFORMANCE The ProStar S4 engine features a new intuitive electronic throttle control with fun and dynamic performance in the under 100 hp class.

NEW BOOST!

SWITCHBACK ASSAULT 146 THE ULTIMATE 50/50 CROSSOVER.

FEATURES/OPTIONS

- MATRYX PLATFORM
- PATRIOT BOOST, 650 PATRIOT ENGINE
- WALKER EVANS RACING® 2.0" VELOCITY SHOCKS
- 7S DISPLAY WITH RIDE COMMAND
- IGX 146 SUSPENSION

SWITCHBACK MATRYX



The ultimate 50/50 Crossover snowmobile delivers pure dominance on-trail and off. Built upon the rider-first Matryx platform, experience complete control with breakthrough rider dynamics. The rider-first, snocross-inspired cockpit has been proven on the track to reduce effort and improve rider connection.



PATRIOT 9R

**SNOW
CHECK**
EXCLUSIVE MODELS



LIGHTNING FAST RESPONSE A purpose built, lightweight cranktrain is 1.2 lbs lighter, and produces race-mod level instant response and immediate power, every single time.

LIGHTWEIGHT POWER The 9R makes 7% more power and up to 12% more torque than an 850 Patriot without any additional weight - it's actually lighter. The additional power in a lighter snowmobile redefines what's possible in the tight and technical terrain.

EFFORTLESS TO RIDE The low inertia engine delivers such immediate and effortless response that it creates a new level of dynamic agility in any terrain.

*Based on internal Polaris testing

SKS 146: GATEWAY TO THE DEEP SNOW

FOR RIDERS WHO WANT DEEP SNOW CAPABILITY AND ON TRAIL VERSATILITY WITH THE SMOOTH AND POWERFUL 650 PATRIOT ENGINE.

INCLUDES

- MATRYX PLATFORM
- 650 PATRIOT ENGINE
- POLARIS IFP SHOCKS
- RMK ADJUSTABLE FRONT SUSPENSION (39-41")
- IGX 146 REAR SUSPENSION
- MESSAGE CENTER DISPLAY





RMK

PRO RMK // RMK KHAOS // SKS

“The RMK Family has always been about backcountry performance. They’ve allowed riders a whole new way to access new terrain.”

— Devon Griffith, Polaris Ambassador

RMK KHAOS THE WORLD'S

2023 650 RMK KHAOS SLASH 146



RMK KHAOS SLASH SLASH THE WEIGHT. SLASH THE DRAG.

The RMK KHAOS Slash delivers ultimate agility and fun factor. The world's best all-mountain snowmobile features a short, tapered tunnel and lightweight design, with the 650 and 850 Patriot and industry leading Patriot Boost and Patriot 9R engines, plus Polaris exclusive tracks, for ultimate fun factor in any terrain.

2023 9R RMK KHAOS SLASH 146
SNOWCHECK EXCLUSIVE



RMK KHAOS SLASH FEATURES/OPTIONS

- PATRIOT BOOST, 9R, 650 OR 850 PATRIOT ENGINE OPTIONS
(PATRIOT BOOST & PATRIOT 9R ARE SNOWCHECK EXCLUSIVE)
- SHORT, FORMED ONE-PIECE TUNNEL
- CENTRALIZED COOLING SYSTEM
- WALKER EVANS RACING® VELOCITY SHOCKS
- OPTIONAL 7S DISPLAY
- 650 PATRIOT: 146"
- 850 PATRIOT: 146" / 155"
- 9R PATRIOT: 146" / 155"
- PATRIOT BOOST: 155"
- SINISTER AMBER ACCENT LIGHTS (ON PATRIOT BOOST & 9R MODELS)

2023 850 RMK KHAOS SLASH 155



BEST ALL-MOUNTAIN SNOWMOBILE

2023 **9R RMK KHAOS SLASH 155**
SNOWCHECK EXCLUSIVE

MATRIX



2023 **850 RMK KHAOS SLASH 146**



2023 **PATRIOT BOOST RMK KHAOS SLASH 155**
SNOWCHECK EXCLUSIVE

RMK KHAOS

ALL-MOUNTAIN PERFORMANCE WITH SUPERIOR VERSATILITY.

The RMK KHAOS delivers industry leading agility and fun factor aboard the rider-first RMK Matryx platform. Purpose built for dynamic deep snow riding, the RMK KHAOS features effortless control and deep snow performance with the high-performance 850 Patriot.

MATRYX

RMK KHAOS FEATURES/OPTIONS

- MATRYX RAISED PLATFORM
- QUICKDRIVE LOW INERTIA DRIVE SYSTEM
- ADJUSTABLE TOE HOLDS
- CAST BULKHEAD / BONDED TECHNOLOGY
- POWDERTRAC XT RUNNING BOARDS
- FORMED ONE-PIECE TUNNEL WITH TAPERED CLOSEOFF
- AVAILABLE IN RMK KHAOS 155



2023 850 RMK KHAOS 155



650 SKS

THE BEST VALUE IN MOUNTAIN PERFORMANCE

For riders who want deep snow capability and on-trail versatility, the all-new 650 SKS is ready.

650 SKS FEATURES/OPTIONS

- MATRYX PLATFORM
- 650 PATRIOT ENGINE
- POLARIS IFF SHOCKS
- RMK ADJUSTABLE FRONT SUSPENSION (39-41")
- IGX 146 REAR SUSPENSION
- MESSAGE CENTER DISPLAY



2023 650 SKS 146

THE MOUNTAIN RIDERS DREAM
MATRYX
 PLATFORM

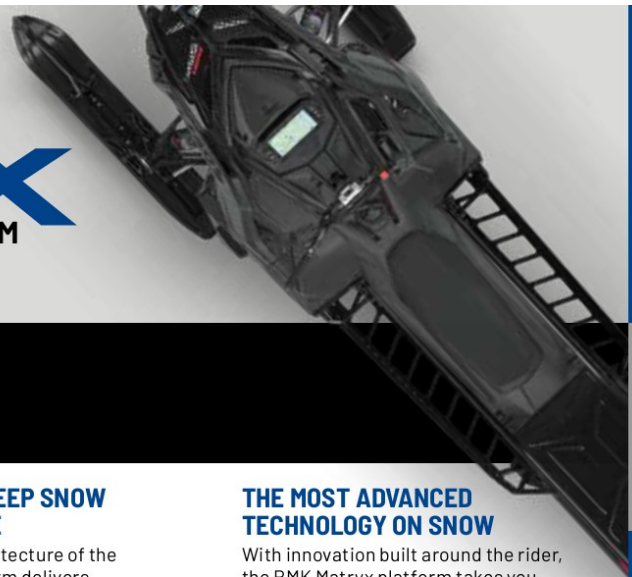

RIDER FIRST DESIGN

REDEFINING THE WORLD'S BEST MOUNTAIN SLED

**EFFORTLESS CONTROL
 IN ANY CONDITION**

The RMK Matryx platform features a next-level rider interface. A sculpted cockpit, narrow seat and tapered tunnel combine to deliver superior rider connection delivering ultimate control in all terrain.

**UNMATCHED DEEP SNOW
 PERFORMANCE**

The patented architecture of the RMK Matryx platform delivers instantaneous lift and lightning fast response. The tapered low drag tunnel and Polaris-exclusive tracks lift the lightweight chassis on top of the snow, and the low-inertia QD drive system creates instant response.

**THE MOST ADVANCED
 TECHNOLOGY ON SNOW**

With innovation built around the rider, the RMK Matryx platform takes you places you only dream about. From the centralized cooling system to the QD2 drivetrain and the integration of the available 7S Display with Ride Command, the RMK Matryx is the most advanced sled on the mountain.

MATRYX RMK FEATURES: UNMATCHED DEEP SNOW PERFORMANCE.



MATRYX RAISED PLATFORM

Designed to increase clearance and reduce drag to keep you on top of the snow. It's purpose-built for mountain riding and allows for improved side hilling, faster and easier climbing, and instantaneous lift allowing the sled to pop onto the snow faster.



QUICKDRIVE DRIVE SYSTEM

The lightest drive system in the industry for the ultimate dynamic agility. Available in QuickDrive or QD2, which has a 10% gear reduction for even quicker response.



ADJUSTABLE TOE HOLDS

The RMK Matryx features adjustable toe holds that can be set to three different sizes to accommodate all boot sizes and rider preferences.

MATRYX SLASH RMK FEATURES: SLASH THE WEIGHT. SLASH THE DRAG.



SLASH TAPERED TUNNEL

The Matryx Slash features a short, tapered tunnel that has significantly reduced drag through the snow. Allowing the track more traction in the deep. Through drag reduction, the control of the sled is greatly enhanced by keeping the sled out of the snow.



PATRIOT ENGINE CHOICES

The Slash models give you exclusive engine options. Choose from the powerful and proven 850 Patriot, the race-mod response of Patriot 9R, or the Patriot Boost with industry-leading power. The RMK KHAOS Slash 146 is also available with the 650 Patriot.



SHORTENED COOLING SYSTEM

The centralized cooling system on the RMK Matryx platform delivers improved cooling capability while reducing snow and ice buildup.

RMK

INDY

SWITCHBACK

TITAN

NORDIC PRO

ENGINES

INDY

VR1 // XCR

"For over 40 years, INDY has stood for performance. This next generation of INDY gives riders the chance to experience a perfect day on the throttle and in control."

— Kevin Boggs, Polaris Ambassador





SNOWMOBILES

RMK

INDY

SWITCHBACK

TITAN

NORDIC PRO

ENGINES



INDY ACCELERATION.

VR1



2023 PATRIOT BOOST INDY VR1 137
SNOWCHECK EXCLUSIVE

INDY VR1 DOMINATING TRAIL PERFORMANCE.

The INDY VR1 delivers unrivaled acceleration, effortless control and intelligent technology on the rider-first Matryx platform.

INDY VR1 FEATURES/OPTIONS

- MATRYX PLATFORM
- PATRIOT BOOST, 650 OR 850 PATRIOT ENGINE OPTIONS
- AVAILABLE WITH PRO-CC 137 SUSPENSION
- WALKER EVANS RACING® VELOCITY SHOCKS
- 7S DISPLAY WITH RIDE COMMAND



2023 650 INDY VR1 137
SNOWCHECK EXCLUSIVE

CONTROL. TECHNOLOGY.

XCR

INDY XCR

RACE-PROVEN STRENGTH & DURABILITY.

Proven on the race track, the INDY XCR on the rider-first Matryx platform leverages decades of dominating performance. The INDY XCR delivers precise corner to corner handling and big bump capability. It is available with 128 or 136 track lengths and 850 Patriot or 650 Patriot engine options.

INDY XCR FEATURES/OPTIONS

- MATRYX PLATFORM
- 650 OR 850 PATRIOT ENGINE OPTIONS
- RACE-READY COMPONENTS
- WALKER EVANS RACING® 2.0" VELOCITY SHOCKS
- 7S DISPLAY WITH RIDE COMMAND
- AVAILABLE WITH PRO-CC 136 SUSPENSION



2023 **650 INDY XCR 136**
SNOWCHECK EXCLUSIVE



2023 **850 INDY XCR 136**
SNOWCHECK EXCLUSIVE

LAKE ROCKET? NO... IT'S MORE LIKE A LAKE, TRAIL, FOREST ROAD, EMPTY-THE-ENTIRE- WATERING HOLE ROCKET.

WHEN WE SET OUT TO BUILD THE NEXT GENERATION OF GO FAST SLEDS, WE WEREN'T GOING TO SETTLE ON A ONE-DIMENSIONAL SLED.



The idea of go-fast, lake racer sleds certainly isn't new. These muscle sleds have been out chasing top speed on the lake for the better part of 30 years, all sharing one key characteristic: weight. These heavy sleds are reluctant to take on anything other than a straight line - and that was a compromise we weren't going to take.

Enter the first no compromise Hypersled: Patriot Boost INDY VR1 and Switchback Assault. Built with the industry's most powerful OEM 2-stroke turbo engine, the lightweight rocketship is ready to take on the frozen lakes, twisty trails, and untracked forest roads alike. 10% more horsepower than the 850 Patriot and up to 110 pounds lighter than our competition, all

built on the rider first Matrix platform. Get ready for an all new Hypersled experience.

**LEARN MORE ABOUT HOW THE PATRIOT BOOST
MAKES THE PERFECT HYPERSLED WITH
MANNERS AT [POLARIS.COM](https://www.polaris.com)**

THE TRAIL RIDERS DREAM
MATRYX
 PLATFORM



RIDER FIRST DESIGN

HANDLING BORN FROM RACE, PERFECTED FOR THE TRAIL

**UNRIVALED ACCELERATION
 IN ALL ENGINE CLASSES**

Its light, rigid aluminum and, on select models, carbon fiber components is designed to deliver class-leading power to weight with new for 2023 Polaris Boost, power delivery from the proven 850 Patriot or the 650 Patriot Engine – the king of the 600-class.

**EFFORTLESS CONTROL
 IN ANY CONDITION**

The snocross-inspired cockpit has been proven on the track to reduce effort and improve rider connection to the sled. Available ultra-premium Walker Evans Racing® Velocity shocks, race-inspired IFS and proven Pro-CC rear suspension combine to create the best handling trail sled ever.

**THE MOST ADVANCED
 TECHNOLOGY ON SNOW**

Technology is built around the rider, including the available 7S Display with Ride Command featuring patented vehicle to vehicle tracking. SmartWarmers, electronically controlled hand warmers controlled by the intuitive left-hand soft touch controls deliver consistent heat throughout your ride.



WHAT'S NEW FOR 2023

**PATRIOT
 BOOST**



HYPERSLED SPEED The Patriot Boost engine delivers turbocharged performance, with 10% more horsepower than the 850 Patriot engine. The Polaris-exclusive design delivers superior response while being easy to ride.

NO COMPROMISE HANDLING The Matryx platform is the industry standard for ride and handling, and the Patriot Boost INDY VR1 is the next evolution. It's up to 110 pounds lighter than the competition, maintaining the effortless control and rider first design without any compromise.

FACTORY BUILT REFINEMENT The patent pending SmartBoost technology produces a new level of unmatched precision and engine stability. The power comes on smooth and keeps going, creating a sled that is fast and easy to ride.

SWITCHBACK

A dense thicket of bare, brown branches in a snowy winter landscape. The branches are thin and intricate, creating a complex web of lines against a background of snow and a clear blue sky. The overall scene is cold and serene.

SWITCHBACK ASSAULT

**"The Matryx Switchback is so versatile,
from clicking off trail miles to floating
swamps it does it all."**

— Michael Berg, Polaris Ambassador



SWITCHBACK

EFFORTLESS CONTROL IN ANY CONDITION.

MATRYX

SWITCHBACK ASSAULT 146 THE ULTIMATE 50/50 CROSSOVER.

The ultimate 50/50 Crossover snowmobile delivers pure dominance on-trail and off. Built upon the rider-first Matryx platform, experience complete control with breakthrough rider dynamics. The rider-first, snocross-inspired cockpit has been proven on the track to reduce effort and improve rider connection.

SWITCHBACK ASSAULT FEATURES/OPTIONS

- MATRYX PLATFORM
- PATRIOT BOOST, 850 OR 850 PATRIOT ENGINE OPTIONS
- WALKER EVANS RACING® 2.0" VELOCITY SHOCKS
- 7S DISPLAY WITH RIDE COMMAND
- IGX 146 SUSPENSION

2023 850 SWITCHBACK ASSAULT 146
SNOWCHECK EXCLUSIVE



2023 850 SWITCHBACK ASSAULT 146
SNOWCHECK EXCLUSIVE

2023 PATRIOT BOOST SWITCHBACK ASSAULT 146
SNOWCHECK EXCLUSIVE



THE CROSSOVER RIDERS DREAM
MATRYX
PLATFORM

RIDER FIRST DESIGN

HANDLING BORN FROM RACE, PERFECTED FOR THE TRAIL

RIDER POSITION

The narrow rider cockpit enables active rider dynamics. The seat, tank, and sculpted body panels are developed by riders for a seamless and effortless rider active experience.

WIND PROTECTION

Improved leg and lower body comfort and protection. Enhanced windshield design for hand protection and less wind buffeting. Updated geometry for improved aerodynamics.

PURPOSEFUL DESIGN

Sleek, purposeful form. Nothing is wasted. Every part has a function. Every detail obsessively perfected.



WHAT'S NEW FOR 2023

HYPERSLED POWER

The Patriot Boost engine delivers turbocharged performance, with 10% more horsepower than the 850 Patriot engine. The Polaris-exclusive design delivers superior response while being easy to ride.

NO COMPROMISE HANDLING

The Switchback Assault is the industry standard for 50/50 crossover performance, on and off the trail. The Patriot Boost Switchback Assault maintains all of the fun factor and control of the Switchback Assault, with a new level of hypersled power and response.

TITAN



S4 TITAN ADVENTURE // 850 TITAN ADVENTURE //

**“You’d never know this was a work horse!
A nimble work horse that just keeps going.
This machine far surpassed any of my
expectations. We use it for breaking trail,
grooming, fishing and plain old fashioned
deep powder horseplay. Absolutely love it!”**

– Joe Nyter, Polaris Rider



TITAN

FUN NEVER WORKED SO HARD.

TITAN ADVENTURE 155 THE ULTIMATE ADVENTURE FOR TWO.

The TITAN Adventure 155 is fully featured and a true do-it-all sled. It comes with a Lock & Ride Versa Touring Passenger Seat with heated passenger grips and footrests, cargo rack, cargo box, tow hitch, mirrors, available Polaris Interactive Digital Display, premium shocks, and multiple windshield options that provide outstanding rider protection. If that's not enough, make it yours with a full selection of Polaris Engineered Accessories to outfit your TITAN for exactly your activities and needs.



TITAN ADVENTURE FEATURES/OPTIONS

- PROSTAR S4 OR 800 H.O. CLEANFIRE ENGINE OPTIONS
- FOX® QS3® SHOCKS
- TITAN ARTICULATED REAR SUSPENSION
- LOCK & RIDE VERSA TOURING PASSENGER SEAT
- LOCK & RIDE VERSA CARGO BOX AND RACK
- POLARIS INTERACTIVE DIGITAL DISPLAY



2023 PROSTAR S4 TITAN ADVENTURE 155

UNMATCHED CAPABILITIES

THE WORLD'S MOST CAPABLE CROSSOVER



2023 800 TITAN ADVENTURE 155



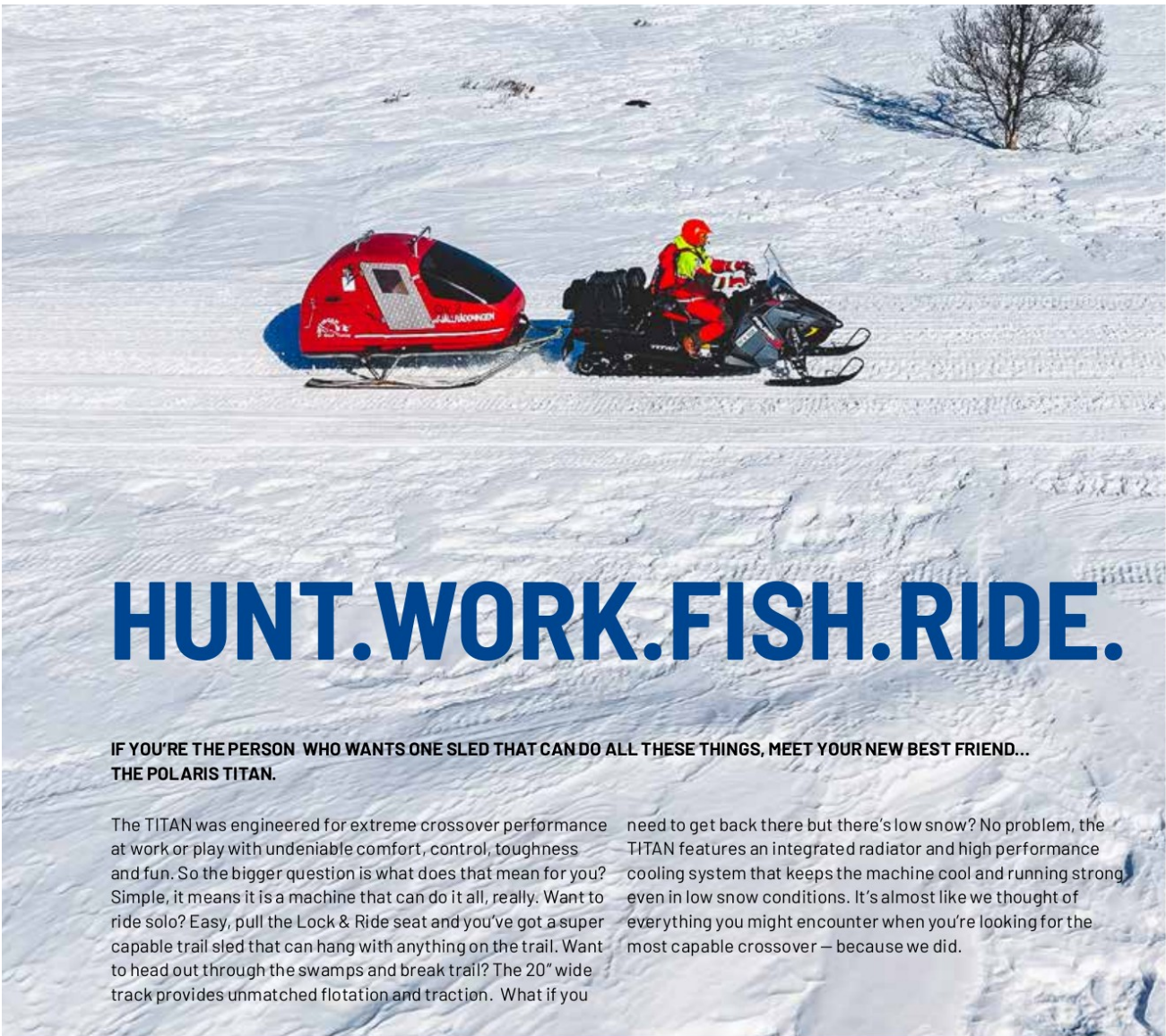

HUNT.WORK.FISH.RIDE.

IF YOU'RE THE PERSON WHO WANTS ONE SLED THAT CAN DO ALL THESE THINGS, MEET YOUR NEW BEST FRIEND... THE POLARIS TITAN.

The TITAN was engineered for extreme crossover performance at work or play with undeniable comfort, control, toughness and fun. So the bigger question is what does that mean for you? Simple, it means it is a machine that can do it all, really. Want to ride solo? Easy, pull the Lock & Ride seat and you've got a super capable trail sled that can hang with anything on the trail. Want to head out through the swamps and break trail? The 20" wide track provides unmatched flotation and traction. What if you

need to get back there but there's low snow? No problem, the TITAN features an integrated radiator and high performance cooling system that keeps the machine cool and running strong even in low snow conditions. It's almost like we thought of everything you might encounter when you're looking for the most capable crossover – because we did.

TITAN: THE VERSATILE, DO-IT-ALL EXTREME CROSSOVER

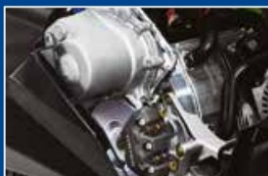

ALPHA TRANSMISSION
Provides smooth shifting and drive ranges to suit even the most extreme conditions or situations. 1200 lb. towing capabilities with High, Low, Reverse, and Neutral.



POWER BOOSTING REGULATOR
This patented industry-first delivers maximum electrical power at idle and low RPMs. Ensures power for rider comfort and convenience features, such as accessory heated seats, hand-warmers, battery charging and other accessories.



LOCK & RIDE® PLATFORM
Integrated design allows for maximum storage, with or without passenger seat. A huge 85lb. (38.5 kg.) carrying capacity and, integrated Lock & Ride mounting system holds cargo box and other storage accessories.



PROSTAR S4 ENGINE The all-new ProStar S4 delivers easy ownership and spirited performance in the under 100 hp class, based on the proven ProStar engine architecture.

NORDIC PRO

S4 NORDIC PRO // 650 NORDIC PRO //

**"You'd never know this was a work horse!
A nimble work horse that just keeps going.
This machine far surpassed any of my
expectations. We use it for breaking trail,
grooming, fishing and plain old fashioned
deep powder horseplay. Absolutely love it!"**

– Joe Nyter, Polaris Rider



NORDIC PRO

NORDIC PRO 146

THE ULTIMATE SPORT-UTILITY SNOWMOBILE.

The outdoors is calling, and Nordic Pro is your answer. The Nordic Pro, built on the Matryx platform, is comfortable and easy to ride taking you anywhere you want to go. The quick and efficient ProStar S4 or 650 Patriot engines deliver performance and fun, making the winter possibilities endless.

NORDIC PRO 146 FEATURES/OPTIONS

- MATRYX PLATFORM
- PROSTAR S4 OR 650 PATRIOT ENGINE OPTIONS
- FOX QS3 SHOCKS
- CARGO RACK AND BUMPER HITCH
- IGX 146 SUSPENSION
- ELECTRIC START
- POLARIS 7S DISPLAY



2023 650 NORDIC PRO 146

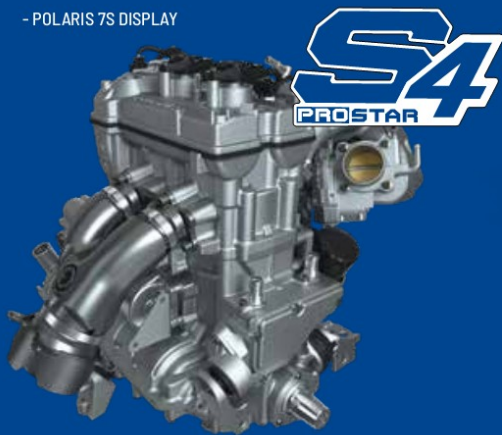

2023 PROSTAR S4 NORDIC PRO 146





ENGINES

CHOICES FOR EVERY RIDER.

From our new ProStar S4 to the revolutionary power of the Patriot Boost, ultimate responsiveness of Patriot 9R, the proven 650 and 850 Patriot, and the 550 Liberty, we're proud to deliver the fun factor that keeps you pushing more miles with reliability and confidence. Our engines are purpose built to integrate seamlessly with the lightweight and agile Polaris platforms, often with class leading Power to Weight ratios. Polaris sets the industry benchmark for ultimate performance.

PATRIOT BOOST

PATRIOT BOOST The Patriot Boost engine delivers superior consistency and control, unrivaled in 2-stroke turbo engines. The patent pending SmartBoost system represents a breakthrough in turbocharged 2-stroke technology. It delivers stable combustion at boost pressures up to 9 psi, enabling industry-leading turbocharged 2-stroke power* with refined, hassle-free performance.

PATRIOT 9R

NEW FOR '23 PATRIOT 9R The latest factory mod engine - a 900cc Patriot delivering lightning fast response and lightweight power. Attack the technical terrain with power and response, with a new level of effortless control.

PROSTAR S4

NEW FOR '23 PROSTAR S4 The all-new ProStar S4 delivers easy ownership and spirited performance, based on the proven ProStar engine architecture.

*Based on internal Polaris testing



850 PATRIOT The 850 Patriot engine was designed from the ground up for class-leading durability, unrivaled acceleration and industry best power-to-weight.



650 PATRIOT The king of the core engine class. The 650 Patriot is built on the proven 850 architecture is designed to deliver unparalleled durability, refined run quality and a new level of fuel economy. Throttle response is instant, power is pure and acceleration is smooth from first pull to full throttle.



LIBERTY 800 H.O. CLEANFIRE The "Proven Polaris Benchmark", is part of the Polaris family of Liberty engines built in the USA. This engine was developed in conjunction with the AXYS platform to deliver ultimate responsiveness, performance and quality with class-leading power-to-weight.

APPAREL

GEAR UP FOR YOUR ADVENTURE.

Adventure invites you to gear up and make the most out of every moment, through the thrills, the fun and the memories. Find the best combination of waterproof and breathable TECH54 riding gear, layering for added warmth, and a helmet that's best suited for your unique riding style. Live boldly both on and off the trail with Polaris lifestyle apparel and represent the brand that helps you get outside, stay outside, and think outside.

APPAREL CONTENTS

- 36 TECH54
- 38 Polaris Heated Apparel
- 40 Men's Apparel
- 56 Women's Apparel
- 62 Youth Apparel
- 66 Helmets
- 72 Goggles
- 74 Gloves
- 76 Boots, Balaclavas & Luggage
- 78 Home & Collectibles





TECH54

TECHNOLOGY TO **CONQUER THE RIDE**

ELEVATE YOUR RIDE WITH EXCLUSIVE TECH54 RIDING GEAR DESIGNED TO KEEP YOU WARM AND DRY.

Our Apparel Center of Excellence developed TECH54—a waterproof, breathable membrane featured in every Polaris jacket, bib and monosuit. This exclusive technology allows perspiration to escape and keeps water out, so no matter how you ride, or where you ride, you stay dry, warm and comfortable.



WATERPROOF/BREATHABLE

TECH54 is our single-layer bonded laminate technology that brings waterproof breathability and riding comfort to a new level in every Polaris jacket and bib.

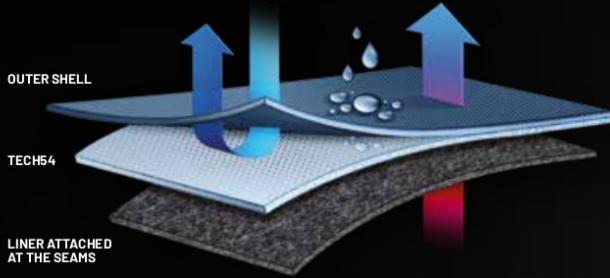

DWR

RESIST MOISTURE

Every Polaris jacket and bib is treated with a DWR (Durable Water Repellent) coating to prevent precipitation from saturating the outer fabric, so your gear doesn't get soggy. The DWR coating causes water to bead up and run off, keeping you comfortable and dry.

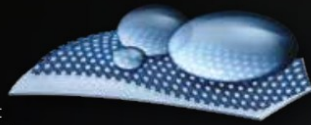

3M Scotchlite[®] Reflective Material

RIDE SAFER

Proven in every weather condition, patented 3M[®] Scotchlite[®] Reflective Material is placed meticulously on each garment and nighttime tested to provide visibility from every angle.

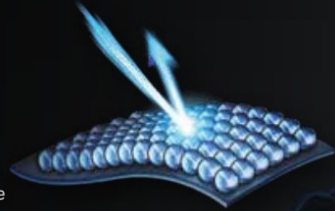

YKK[®] ZIPPERS

STAY PROTECTED

Quality construction you can trust.

3M Thinsulate[®] INSULATION

BE WARMER

3M[®] Thinsulate[®] Insulation is zonally mapped on insulated apparel to provide extra insulation in high wind exposure areas.



HOW IT WORKS TO ELEVATE YOUR RIDE.

5k/5k, 10k/10k OR 20k/20k

WATERPROOF

The first number (5k, 10k or 20k) refers to the waterproof rating.

BREATHABILITY

The second number (5k, 10k or 20k) refers to how much water vapor the material can expel through the outerwear to release heat—and keep you dry from the inside.

DIFFERENT RATINGS FOR DIFFERENT RIDES

Choose your TECH54 rating based on the weather conditions and your level of exertion.

5k/5k: best for colder and drier conditions and moderate activity

10k/10k: best for wet riding conditions and high-activity riding

20k/20k: best for extremely wet riding conditions and the most aggressive riding



DIVE DEEPER INTO TECH54 AT POLARIS.COM/TECH54

NEW

POLARIS

HEATED APPAREL

Keep warm even on the coldest days with Polaris Heated Apparel. By keeping the heat close to your body, you can stay out for a longer, more comfortable ride. The Polaris Heated Apparel lineup includes the Heated Vest, Heated Base Layers, and a Heated Glove Liner for both men and women. Easily control your heat setting with the touch of a button.



THE HEATED ADVANTAGE

The Polaris Heated Apparel lineup features lightweight, moisture wicking fabric infused with stretch panels and a chafe free waistband to give you the most comfortable layering to wear on all of your cold weather adventures, on or off the trail.

Our lineup has multiple heat panels for evenly distributed heat for maximum warmth and comfort. Easily adjust between 4 heat settings for changing weather conditions with built-in buttons.

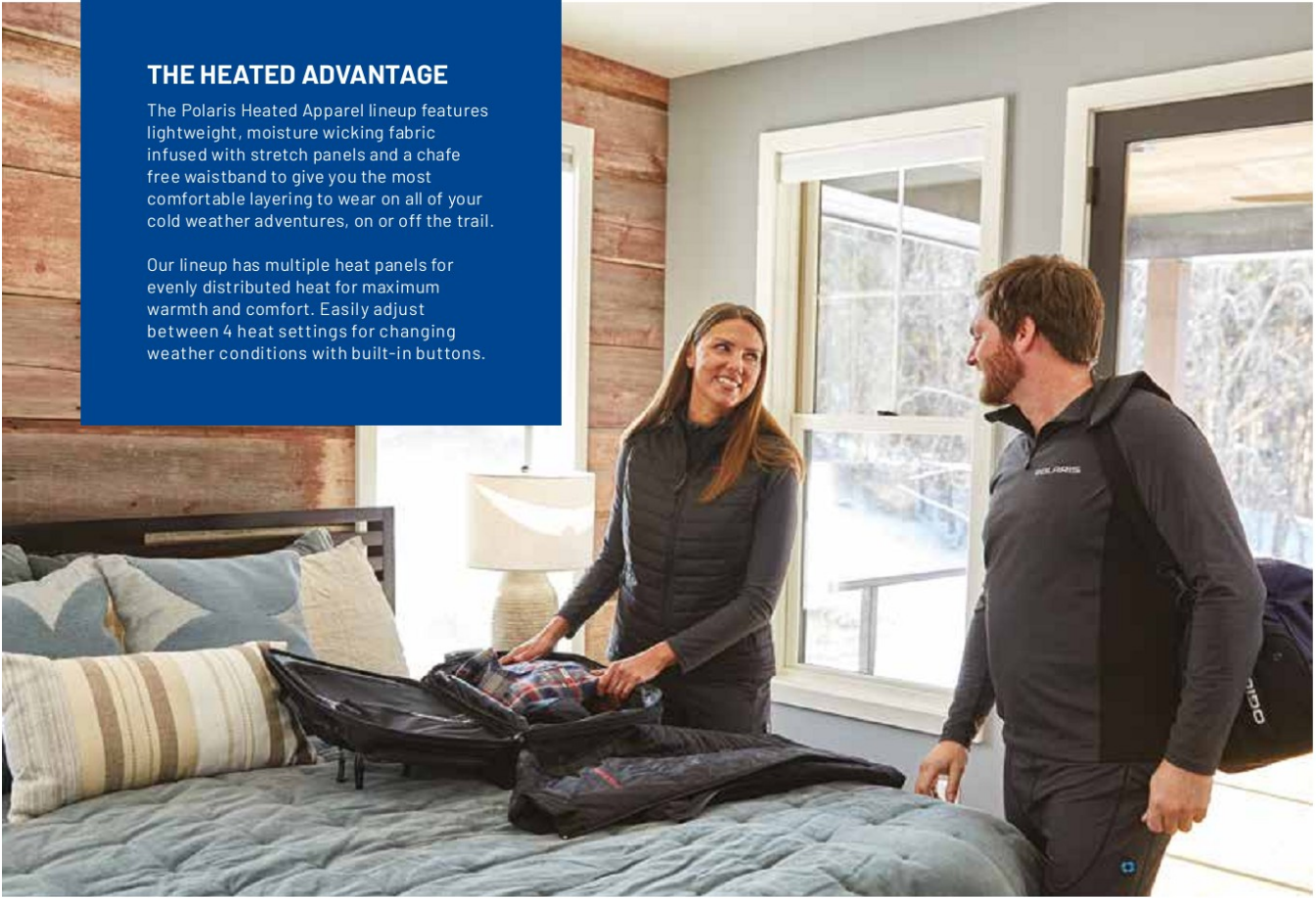

NEW
HEATED VEST

MEN'S	WOMEN'S
S-3XL 2833022	S-3XL 2833036
P. 18	P. 36



NEW
HEATED BASE LAYERS

MEN'S	WOMEN'S
Top 2833031	Top 2833033
Bottom 2833032	Bottom 2833034
P. 19	P. 36



NEW
HEATED GLOVE LINER

UNISEX
S-3XL 2833044
P. 62



MEN'S TECHNICAL GEAR

Our innovative designs and advanced technical materials keep you warm, dry, and happy - head to toe - on every ride. TECH54 jackets, bibs, and monosuits provide ultimate protection and comfort for every type of rider. And our helmets offer styles, designs, and features just right for the way you ride.



LAYERING

Polaris outerwear is designed to work together as a smart solution that integrates multiple layers for ultimate performance. We offer a range of Base Layer and Mid-Layer options designed to deliver comfort, warmth and mobility for every riding style.



LIFESTYLE

Take your pick from our wide assortment of comfortable and stylish casual wear. You'll find T-shirts, sweatshirts, jackets, beanies, ballcaps and more that reflect your unique style and personality to show off your Polaris pride.



**TECH54
PRO**



BLACK/LIME
S-3XL
2862436



BLACK
S-3XL
2862574

20k/20k



APEX

JACKET

ADVANCED UNINSULATED JACKET OFFERS MAXIMUM WATERPROOFNESS AND BREATHABILITY

- Three-layer stretch woven fabric for ultimate freedom of movement
- Features TECH54 Pro bonded internal laminate with 20k/20K internal properties
- Three external pockets (two hand, one chest)
- Two pit vents to help circulate air to keep you cool
- Shock-cord adjustable bottom hem, integrated snow skirt, and hand gaiters keep snow out
- Highly visible in low light conditions with 3M[®] Scotchlite[®] Reflective Material

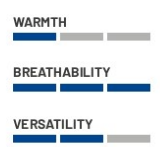

BIB

ADVANCED UNINSULATED BIB OFFERS MAXIMUM WATERPROOFNESS AND BREATHABILITY WITH ENHANCED PROTECTION

- Three-layer stretch woven fabric for ultimate freedom of movement
- 300 denier reinforcements in high impact areas with built-in kneepads for ultimate protection
- Features TECH54 Pro bonded internal laminate with 20k/20K internal properties
- Two inner-thigh vents
- Two-way zipper
- Storm cuffs with boot-lace retention snaps
- Highly visible in low light conditions with 3M[®] Scotchlite[®] Reflective Material

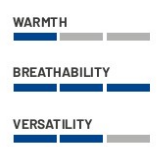



TECH54

APPAREL

MEN'S APPAREL

WOMEN'S APPAREL

YOUTH APPAREL

HELMETS

GOGGLES

GLOVES

BOOTS, BALACLAVAS,
& LUGGAGE

HOME & COLLECTIBLES



NEW
ORANGE
S-3XL
2833007

20K/20K

DWR

3M Thinsulate INSULATION

3M Scotchlite Reflective Material

YKK ZIPPERS

BACKCOUNTRY MONOSUIT

ADVANCED INSULATED ONE-PIECE FOR WARMTH IN ANY RIDING CONDITION, ENABLES FREE RANGE OF MOTION AND PREVENTS SNOW INTRUSION TO KEEP YOU DRY AND COMFORTABLE

- Durable 150 denier poly shell is tear- and snag-resistant and treated with superior DWR to shed snow and water from the outer shell
- Features TECH54 bonded internal laminate with 20k/20k properties
- One-piece construction ensures powder stays on the outside
- 4-way stretch material allows for extreme mobility and comfort
- Increased storage including four external pockets (two hand, one chest, one thigh)
- 140g 3M® Thinsulate® Insulation

WARMTH

BREATHABILITY

VERSATILITY



IMPROVED MOBILITY

Action back for ease of movement and articulated fit for maximum mobility and comfort.



CUSTOMIZED FIT

Adjustable waist tabs and internal suspenders for a comfortable and customized fit.



SUPERIOR VENTING

Two vents on the side and two vents on the leg help heat as needed when riding, and the leg zips can be opened for extra venting when off the sled.



MEN'S TRAIL GEAR

TECH54



NEW
BLACK
S-3XL
2833000



NEW
BLACK
S-3XL
2833058

5K/5K

DWR

3M Thinsulate INSULATION

3M Scotchlite Reflective Material

YKK ZIPPERS

NORTHSTAR

JACKET

INSULATED JACKET PROVIDES GREAT WARMTH WITH MINIMAL BULK AT INCREDIBLE VALUE

- Durable 300 denier poly shell is tear- and snag-resistant and treated with superior DWR to shed snow and water from the outer shell
- Features TECH54 bonded internal laminate with 5k/5k properties
- Insulated with 180g insulation in body and 100g in arms
- Shock-cord adjustable hem to keep snow out
- Highly visible in low light conditions with 3M® Scotchlite® Reflective Material

WARMTH



BREATHABILITY



VERSATILITY



BIB

ZONAL INSULATION PROVIDES GREAT WARMTH WITH MINIMAL BULK AT AN INCREDIBLE VALUE

- Durable 300 denier poly shell is tear- and snag-resistant and treated with superior DWR to shed snow and water from the outer shell
- Features TECH54 bonded internal laminate with 5k/5k properties
- Insulated with 180g insulation in upper front of legs and lower back and 100g on upper backside
- Two-way front zipper
- Storm cuffs with boot-lace retention snaps
- Highly visible in low light conditions with 3M® Scotchlite® Reflective Material

WARMTH



BREATHABILITY



VERSATILITY





APPAREL

HEM'S APPAREL

WOMEN'S APPAREL

YOUTH APPAREL

HELMETS

GOGGLES

GLOVES

BOOTS, BALACLAVAS,
& LUGGAGE

HOME & COLLECTIBLES

5K/5K

DWR

3M Thinsulate INSULATION

3M Scotchlite Reflective Material

YKK ZIPPERS

BLACK
S-3XL
2862429

TITAN

JACKET

ADVANCED INSULATED JACKET WITH ENHANCED DURABILITY AND SUPERIOR WARMTH TO OUTLAST THE ELEMENTS

- Durable 600 denier Cordura® Outer Fabric is tear- and snag-resistant and treated with DWR to shed snow and water from the outer shell to keep you dry
- Features TECH54 bonded internal laminate with 5k/5k properties
- Insulated with 300g insulation in body, 220g in arms, and 100g in collar
- Ample storage with three external pockets and 2 internal pockets
- Shock-cord adjustable hem and snow skirt to keep snow out
- Highly visible in low light conditions with 3M® Scotchlite® Reflective Material

WARMTH



BREATHABILITY



VERSATILITY



MEN'S LAYERING



REVOLVE VEST

BLACK/GRAY
S-3XL | 2862565

DURABLE AND WARM REVERSIBLE VEST OFFERS TWO STYLES IN ONE

- Durable windbreak outer fabric helps protect from the elements
- 140g 3M® Thinsulate® Insulation keeps you warm in cold weather
- Vest is reversible



HEATED VEST

NEW
BLACK
S-3XL | 2833022

WARMTH WITH THE TOUCH OF A BUTTON

- Perfect for any outdoor activity
- Down-proof machine washable material with 160g of insulation for warmth with or without the heater turned on
- Powered by a small rechargeable battery (included) that can also be used to charge a cellphone; Battery not machine washable, remove prior to washing
- Easily adjust between 4 heat settings for changing weather conditions with built-in buttons

MEN'S BASE LAYERS

Quick-drying and quick-wicking. Rests against your skin to regulate your overall body temperature by wicking away moisture.



BLACK | TOP
S-3XL | 2861451

MIDWEIGHT BASE LAYER

LIGHTWEIGHT, COMFORTABLE, MOISTURE-WICKING BASE LAYER

- Comfortable stretch fabric to allow for maximum movement
- 92% polyester, 8% spandex
- 220g fleece lined brushed fabric provides comfort and warmth

WARMTH



BLACK | BOTTOM
S-3XL | 2861452



MEN'S MID-LAYERS

Insulating layers for the right level of warmth for your riding conditions.



NEW
ORANGE

S-3XL | 2833025

TECH QUARTER-ZIP ★ TOP SELLER

FLEECE LINED MID-LAYER FOR ESSENTIAL WARMTH WHILE RIDING WITH THE STYLE AND COMFORT TO WEAR ANYWHERE

- Fleece-lining keeps you cozy and warm
- Move freely with four-way stretch material
- Contoured, slim fit

WARMTH



NEW BLUE

S-3XL | 2833023



BLACK/GRAY

S-3XL | 2862622

SWITCHBACK MID-LAYER

BATTLE THE COLD WITHOUT THE BULK AND SLIDE YOUR JACKET ON EASILY

- 280g of breathable fleece and a wear-resistant, sleek polyester face
- Inner spandex layer enhances fit without restricting movement
- Hand pockets perfect for mid-day stops when you remove your outer shell

WARMTH



BLACK

S-3XL | 2862568

TITAN MID-LAYER

VERSATILE MID-LAYER CAN BE WORN ALONE OR AS AN EXTRA LAYER

- 319g Polartec® Thermal Pro® Rib Sweater provides great warmth
- Breathable material moves sweat to the outer surface
- Nylon overlay is comfortable and light

WARMTH



NEW BLACK/LIME

S-3XL | 2833024

NORTHSTAR MID-LAYER

EXTREMELY WARM YET BREATHABLE MID-LAYER, PERFECT FOR RIDING

- 280g of breathable fleece for added warmth
- Offers durable protection against the elements with a wear-resistant polyester face and wind-block layer on chest
- Designed to fit under outer shell when riding

WARMTH



NEW
ORANGE
S-3XL | 2833027



CHARCOAL
S-3XL | 2860865



NEW
BLUE
S-3XL | 2833028



BLACK *TOP SELLER
S-3XL | 2861434



BRONZE
S-3XL | 2860864

SOFTSHELL JACKET

VERSATILE LIGHTWEIGHT JACKET THAT'S PERFECT FOR EVERYDAY WEAR

- Casual jacket armed with rugged and warm features for everyday wear
- Superior DWR prevents precipitation from saturating the jacket's exterior
- Lined with soft fleece for warmth
- Removable hood and underarm venting, three external pockets and one internal chest pocket

FLANNEL JACKET

SHERPA FLEECE LINED JACKET DELIVERS EXCEPTIONAL WARMTH AND COMFORT

- Warm sherpa lined fleece material
- Insulation to keep you warm
- Plenty of storage for your valuables
- Durable, snap buttons



BLACK
S-3XL | 2861608

WORK JACKET

WARM AND RUGGED JACKET THAT'S TOUGH FOR WORK AND STYLISH FOR PLAY

EXTERNAL FEATURES:

- Constructed of Nylon 6, a durable, tear-resistant non-stretch woven fabric
- Coated with Durable Water Repellency (DWR) to provide water-resistance in the elements
- Four external pockets for maximum gear storage

INTERNAL FEATURES:

- 80g 3M® Thinsulate® for added warmth
- Built-in action back for increased range of motion
- Internal zipper pocket
- Brushed flannel trim

MEN'S LIFESTYLE



ICON HOODIE ★ TOP SELLER

NW Black/Red | S-3XL | 2833065
 Green | S-3XL | 2861495
 Gray | S-3XL | 2862487



STAPLE HOODIE

Black | S-3XL | 2833068



ROGUE HOODIE ★ TOP SELLER

NW Black | S-3XL | 2833062
NW Navy | S-3XL | 2833063
 Gray | S-3XL | 2862485



JOURNEY HOODIE

NW Navy | S-3XL | 2833066
 Black | S-3XL | 2862489



TECH FULL-ZIP HOODIE ★ TOP SELLER
■ ■ ■ Red | S-3XL | 2833064
 Gray | S-3XL | 2861493



CREW SWEATSHIRT
■ ■ ■ Gray | S-3XL | 2833067
 Black | S-3XL | 2862488
 Navy | S-3XL | 2861497



STAMP HOODIE
■ ■ ■ Green | S-3XL | 2833061
 Black | S-3XL | 2862484
 Navy | S-3XL | 2861500



RETRO LOGO HOODIE
■ ■ ■ Navy | S-3XL | 2833060
 Black/Gray | S-3XL | 2862483
 Gray/Red | S-3XL | 2861504



PURSUIT HOODIE
■ ■ ■ Black | S-3XL | 2833076
 Green | S-3XL | 2833077



VENTURE HOODIE
 Navy/White | S-3XL | 2862492



BLACK
BACK

PERFORMANCE LONG SLEEVE
■ ■ ■ Gray | S-3XL | 2833168
 Black | S-3XL | 2862507



ICON LONG SLEEVE
■ ■ ■ Lime | S-3XL | 2833083

MEN'S LIFESTYLE



DASH LONG SLEEVE
Black | S-3XL | 2861582



ICON TEE ★ TOP SELLER

- ■ ■ **NEW** Lime | S-3XL | 2833079
- Green | S-3XL | 2862501
- Black | S-3XL | 2861570



FOREST
GREEN
BACK

■ ■ ■ **NEW**
GRAPHIC TEE

Forest Green | S-3XL | 2833087



HERITAGE TEE ★ TOP SELLER

- Black | S-3XL | 2861579
- Navy | S-3XL | 2860573

FLAG TEE

Navy | S-3XL | 2862500



STAMP TEE

NEW Navy | S-3XL | 2833078
 Green | S-3XL | 2861564
 Black | S-3XL | 2862496



CORE TEE ★ TOP SELLER

NEW Navy | S-3XL | 2833081
 Black | S-3XL | 2861572
 Red | S-3XL | 2862502



BLACK
FRONT

NEW
EVOLUTION TEE

Black | S-3XL | 2833088



BRAAAAP TEE

Black | S-3XL | 2862503



RACING TEE

Black | S-3XL | 2861580



THINK OUTSIDE TEE

NEW Green | S-3XL | 2833080
 Navy | S-3XL | 2861566
 Black | S-3XL | 2861567



CORE POLO

Black | S-3XL | 2861489
 Navy | S-3XL | 2861490



CORE CAP ★ TOP SELLER
NEW Red | One Size | 2833123
 Gray | One Size | 2862594
 Navy | One Size | 2861523



NEW
LEATHER PATCH CAP
 Black | One Size | 2833129



ELLIPSE PATCH TRUCKER HAT ★ TOP SELLER
NEW Orange | One Size | 2833124
 Gray | One Size | 2861531
 Black | One Size | 2861533
 Navy | One Size | 2861532



TONAL HAT
 Black/Red | One Size | 2861526
 Navy | One Size | 2861525



POLARIS RACING HAT
 Black | S-M | 2861528
 Black | L-XL | 2861529



HIGHLAND CAP
 Tan | One Size | 2860893



CHECKERED HAT
 Black | One Size | 2861522



STEALTH CAMO CAP
 Camo | One Size | 2861527



HUNTER ORANGE HAT
 Orange | L/XL | 2862545



STAPLE BEANIE

Black | One Size | 2833116
Navy | One Size | 2833117



NORTHSTAR BEANIE ★ TOP SELLER

Navy | One Size | 2861518
Black | One Size | 2861519



SWITCHBACK BEANIE

NEW Blue | One Size | 2833115
Black | One Size | 2862532
Gray | One Size | 2862533



RACING BEANIE

Gray | One Size | 2861517



CORE BEANIE

NEW Blue | One Size | 2833114
Black | One Size | 2862530
Gray | One Size | 2862531
Orange | One Size | 2862595



WOMEN'S TECHNICAL GEAR

Our innovative designs and advanced technical materials keep you warm, dry, and happy - head to toe - on every ride. TECH54 jackets, bibs, and monosuits provide ultimate protection and comfort for every type of rider. And our helmets offer styles, designs, and features just right for the way you ride.



LAYERING

Polaris outerwear is designed to work together as a smart solution that integrates multiple layers for ultimate performance. We offer a range of layering options designed to deliver comfort, warmth and mobility for every riding style.



LIFESTYLE

Take your pick from our wide assortment of comfortable and stylish casual wear. You'll find T-shirts, sweatshirts, jackets, beanies, ballcaps and more that reflect your unique style and personality to show off your Polaris pride.



TECH54

BLACK/PINK
S-3XL
2862443

5K/5K

DWR

3M Thinsulate
INSULATION

3M Scotchlite[®]
Reflective Material

YKK[®]
ZIPPERS

NORTHSTAR 2.0

JACKET

INSULATED AND DURABLE JACKET DELIVERS GREAT WARMTH

- Durable 300 denier poly shell is tear- and snag- resistant and treated with superior DWR to shed snow and water from the outer shell
- Features TECH54 bonded internal laminate with 5k/5k properties
- Insulated with 180g insulation in body and 100g in arms
- Shock-cord adjustable bottom hem and wrist gaiters keep the snow out
- Highly visible in low light conditions with 3M[®] Scotchlite[®] Reflective Material

WARMTH

BREATHABILITY

VERSATILITY

WOMEN'S LAYERING

WOMEN'S BASE LAYERS

Quick-drying and quick-wicking. Rests against your skin to regulate your overall body temperature by wicking away moisture.

WOMEN'S MID-LAYERS

Insulating layers for the right level of warmth for your riding conditions.



NEW
BLACK
S-3XL | 2833037

NEW
RADIANT GREEN
S-3XL | 2833038

SWITCHBACK MID-LAYER

BATTLE THE COLD WITHOUT THE BULK AND SLIDE YOUR JACKET ON EASILY

- 280g of breathable fleece and a wear-resistant, sleek polyester face
- Inner spandex layer enhances fit without restricting movement
- Hand pockets perfect for mid-day stops when you remove your outer shell

WARMTH



HEATING ELEMENT

BLACK
S-3XL | 2833036

NEW

HEATED VEST BASE-LAYER

COMFORT WITH THE TOUCH OF A BUTTON

- Perfect for any outdoor activity
- Down-proof machine washable material with 160g of insulation for warmth with or without the heater turned on
- Powered by a small rechargeable battery (included) that can be used to charge a cellphone; Battery not machine washable, remove prior to wash
- Easily adjust between 4 heat settings for changing weather conditions with built-in buttons

WARMTH



ADJUST FROM LEVEL 1 TO 4 WARMTH WITH THE TOUCH OF A BUTTON



NEW
RADIANT GREEN
S-3XL | 2833042

BLACK/GRAY
S-3XL | 2862458

TITAN MID-LAYER

EXTREMELY WARM YET BREATHABLE MID-LAYER, PERFECT FOR RIDING

- 319g Polartec® Thermal Pro® Rib Sweater provides great warmth
- Breathable material moves sweat to the outer surface
- Nylon overlay is comfortable and light

WARMTH



APPAREL

MEN'S APPAREL

WOMEN'S APPAREL

YOUTH APPAREL

HELMETS

GOGGLES

GLOVES

BOOTS, BALACLAVAS, & LUGGAGE

HOME & COLLECTIBLES

WOMEN'S LIFESTYLE



TECH FULL-ZIP HOODIE ★ TOP SELLER
NEW Black | S-3XL | 2833097

NEW
RADIANT GREEN
 S-3XL | 2833040

SOFTSHELL JACKET

VERSATILE LIGHTWEIGHT JACKET THAT'S PERFECT FOR EVERYDAY WEAR

- Casual jacket armed with rugged and warm features for everyday wear
- Superior DWR prevents precipitation from saturating the jacket's exterior
- Lined with 280g of soft fleece for warmth
- Removable hood and underarm venting, three external pockets and one internal chest pocket



ELLIPSE PATCH TRUCKER HAT ★ TOP SELLER
 Pink | One Size | 2861549



NEW
STAPLE HOODIE
 Black | S-3XL | 2833095



CHECKERED HOODIE ★ TOP SELLER
 Black | S-3XL | 2861609



ICON HOODIE
NEW Gray | S-3XL | 2833099
 White | S-3XL | 2862512



NEW
FLAG TEE
White | S-3XL | 2833162



ICON TEE **TOP SELLER**
Black | S-3XL | 2862519



NEW
CORE TANK
Black | S-3XL | 2833161



NEW
MOUNTAIN TEE
Pink | S-3XL | 2833106



THINK OUTSIDE TEE **TOP SELLER**
Pink | S-3XL | 2862518
Black | S-3XL | 2861590



ADVENTURE TEE
NEW Pink | S-3XL | 2833104
Black Frost | S-3XL | 2862628



BRAAAAAP TEE
Gray | S-3XL | 2861593



POLARIS NORTHSTAR BEANIE
Gray | One Size | 2862536
Pink | One Size | 2862537



REMOVABLE POM BEANIE **TOP SELLER**
NEW Black | One Size | 2833119
Green | One Size | 2861513
Gray | One Size | 2861514



POLARIS POM BEANIE
Maroon | One Size | 2862535



DREAM BEANIE
Bronze | One Size | 2861515
Black | One Size | 2861516



THE RIGHT GEAR

Enjoy peace of mind when snow-loving kids head out in premium Polaris apparel. Our technical outerwear keeps them warm and dry, hour after hour. In and out of the snow, they can live the Polaris lifestyle in casual wear featuring designs made for them.

TECH54



NEW
BLACK
S-XL
2833045



NEW
BLACK
S-XL
2833049

5K/5K

DWR

3M Thinsulate INSULATION

3M Scotchlite Reflective Material

YKK ZIPPERS

SWITCHBACK

JACKET

- Durable 300 denier poly shell is tear- and snag- resistant and treated with superior DWR to shed snow and water from the outer shell
- Features TECH54 bonded internal laminate with 5k/5k properties
- 150g insulation in body and 100g in arms
- Shock-cord adjustable bottom hem keeps snow out
- Three external pockets (two hand, one chest)
- Highly visible in low light conditions with 3M® Scotchlite® Reflective Material

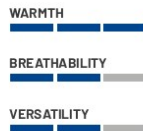

BIB

- Durable 300 denier poly shell is tear- and snag- resistant and treated with superior DWR to shed snow and water from the outer shell
- Features TECH54 bonded internal laminate with 5k/5k properties
- Insulated with 150g insulation in front and 100g in back
- Grow with Me Extension feature adjusts as your child grows taller
- Two external hand pockets
- Highly visible in low light conditions with 3M® Scotchlite® Reflective Material

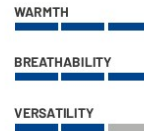

NORTHSTAR GLOVE

- Mapped insulation with 200g on back of hand and 100g on palm
- Goggle squeegee on index finger and nose wipe on the back of thumb
- Gauntlet shock-cord closure to keep snow out



BLACK
S-XL
2861463

YOUTH LIFESTYLE



TECH FULL-ZIP HOODIE
NEW Red | S-XL | 2833111
 Maroon | S-XL | 2861511
 Black/Blue | S-XL | 2861512



ICON TEE
NEW Orange | S-XL | 2833169



YOUTH BRAAAAAP TEE
 Red | S-XL | 2861600
 Black | S-XL | 2860585



YOUTH SWITCHBACK BEANIE
 Blue | One Size | 2862550
 Gray | One Size | 2862551

YOUTH HELMETS



BLACK/RED
 S-L | 2862584



GRAY
 S-L | 2862585



BLACK
 S-L | 2862583

YOUTH TACTICAL 2.0 HELMET

BUILT FROM THE GROUND UP WITH INNOVATIVE FEATURES FOR ULTIMATE COMFORT AND CONTROL



SHELL

- Shock-resistant, injection-molded thermoplastic

FEATURES

- Venturi Vent system generates negative pressure at velocity and pulls moist air from the breath box
- Integrated eyeport seal is cointegrated with the breath box and creates a draft-free seal with 509 goggles for unparalleled warmth and clear field of view
- Magnetic Fidlock® chin-strap technology to enable faster securing and removing of the helmet
- DOT-and ECE 22.06-approved

FUELING YOUR PASSION

Relentlessly driven by our passion for riding and the outdoors, 509 is the fuel that enables you to live your passion for adventure through innovative products and inspiring storytelling.

The lineup of 509 helmets for Polaris features innovative technology, next-level design, and the versatility to ride confidently in any terrain. Whether you're ascending deep mountain powder or enjoying a perfectly groomed trail, 509 for Polaris has a helmet to fit your riding passion.



APPAREL

MEN'S APPAREL

WOMEN'S APPAREL

YOUTH APPAREL

HELMETS

GOGGLES

GLOVES

BOOTS, BALACLAVAS, & LUGGAGE

HOME & COLLECTIBLES



IGNITE

IGNITE DUAL-PANE CLIMATE CONTROL

Ride confidently knowing your vision will be fog-free and crystal clear as you maneuver through the trails.

FIDLOCK

MAGNETIC TECHNOLOGY

The lineup of 509 helmets for Polaris features Fidlock® technology, an easy-on and easy-off magnetic closure device that delivers a quick, secure closure every time.



EASY ONE-HAND OPENING

EVEN WITH GLOVES

DOT- AND ECE-APPROVED

519 FOR
POLARIS

RETRO
XS-2XL | 2862463



BLACK/RED
XS-2XL | 2862462

VERSATILITY DELTA R3L

509 DELTA R3L HELMET

IGNITE FIDLOCK

UNLIMITED VERSATILITY IN DUAL-SPORT, FULL-FACE OR OPEN CONFIGURATIONS WITH PREMIUM PROTECTION

SHELL

- Lightweight polycarbonate

WEIGHT

- 1,680g

FEATURES

- Dual-sport, full-face or open face configuration options
- Dual-pane anti-scratch, anti-fog coated ITO electric clear shield
- Comes standard with the Fidlock® easy-open magnetic strap buckle
- Drop-down internal sun shield in amber
- Push-button removable shield
- Removable cold-weather chin curtain
- Removable/washable liner and cheek pads
- DOT- and ECE 22.05-approved

**509 FOR
POLARIS**

BLACK
S-2XL | 2861464



MODULAR DELTA R4

509 DELTA R4 HELMET

IGNITE FIDLOCK

ULTIMATE ALL-IN-ONE MODULAR DESIGN WITH EXCEPTIONAL VISION, COMFORT AND CONVENIENCE

SHELL

- Lightweight polycarbonate

WEIGHT

- 1,880g

FEATURES

- Wide field of view for extended peripheral sightlines
- Heated dual-pane shield for ice- and fog-free vision
- IGNITE heated shield is powered by your snowmobile's battery, and comes with all required connection cables
- Easy one-handed, glove-friendly latch activation
- Magnetic Fidlock® chin strap secures quickly
- Adjustable flow-through venting for comfort
- DOT- and ECE 22.05-approved

LEARN MORE AT
[POLARIS.COM/SNOWHELMETS](https://www.polaris.com/snowhelmets)

APPAREL

MEN'S APPAREL

WOMEN'S APPAREL

YOUTH APPAREL

HELMETS

GOGGLES

GLOVES

BOOTS, BALACLAVAS,
& LUGGAGE

HOME & COLLECTIBLES

67

PRO FOR
POLARIS

CARBON FIBER
BLACK/LIME
XS-4XL | 2861473



ALTITUDE

509 ALTITUDE 2.0 HELMET

FIDLOCK

LIGHTWEIGHT DESIGN, PERFORMANCE-INFUSED STYLE, AND GOPRO® MOUNTING CAPABILITY

SHELL

- Thermoplastic poly alloy outer shell

WEIGHT

- Composite as low as 1,200g
- Carbon fiber as low as 1,150g

FEATURES

- Strong, light weight construction of carbon fiber or composite
- Superior fit for all-day comfort
- Integrated Pro Series breath box provides excellent ventilation and air flow
- One-piece eyepoint creates draft-free seal with 509 goggles
- Magnetic Fidlock® chin-strap technology and integrated GOPRO® mount
- DOT- and ECE 22.05-approved

**ATV FOR
POLARIS**

MATTE BLACK
XS-4XL | 2862468



TACTICAL

TACTICAL 2.0 HELMET

FIDLOCK

COMBINES STYLE WITH VERSATILITY FOR ULTIMATE COMFORT AND CONTROL

SHELL

- Shock-resistant, injection-molded thermoplastic

WEIGHT

- 1,300g

FEATURES

- Venturi Vent system generates negative pressure at velocity and pulls moist air from the breath box
- Integrated eyepoint seal is cointegrated with the breath box and creates a draft-free seal with 509 goggles for unparalleled warmth and clear field of view
- Magnetic Fidlock® chin-strap technology
- DOT-and ECE 22.06-approved

LEARN MORE AT
[POLARIS.COM/SNOWHELMETS](https://www.polaris.com/snowhelmets)

APPAREL

MEN'S APPAREL

WOMEN'S APPAREL

YOUTH APPAREL

HELMETS

GOGGLES

GLOVES

BOOTS, BALACLAVAS,
& LUGGAGE

HOME & COLLECTIBLES

69

NEW
BLUE

XS-2XL | 2833143



BLACK/GRAY
XS-2XL | 2861558



BLACK/LIME
XS-2XL | 2861559



BLACK
XS-2XL | 2861557

TENACITY

TENACITY 4.0 HELMET

COMBINATION OF MODERN STYLE AND PREMIUM PROTECTION WITH INCREDIBLE VALUE

SHELL

- Shock-resistant, injection-molded thermoplastic

WEIGHT

- 1,500g

FEATURES

- Through-flow, full-helmet ventilation
- ProClip quick release chin strap allows you to fasten the chin strap in seconds
- Removable breath box
- Toolless adjustable roost shield
- Removable, washable liner
- DOT- and ECE 22.05-approved

LEARN MORE AT
POLARIS.COM/SNOWHELMETS



APPAREL

MEN'S APPAREL

WOMEN'S APPAREL

YOUTH APPAREL

HELMETS

GOGGLES

GLOVES

BOOTS, BALACLAVAS,
& LUGGAGE

HOME & COLLECTIBLES

71

GOGGLES

NEW
STEALTH
2833155⁵



CLEAR SMOKE

NEW
RETRO
2833156



CLEAR SMOKE

NEW
BLACK/RED
2833157



MIRRORED FIRE ROSE



CARRY MULTIPLE LENSES SO YOU CAN EASILY ADJUST FOR LIGHTING FROM DAWN TO DUSK

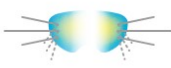

MIRRORED

- Reduces glare by reflecting light
- Maintains visibility of LCD readouts
- Paired with lighter tints to offset darkening



POLARIZED

- Substantially reduces glare & blinding
- Blocks horizontal light waves
- Decreases eyestrain



BLUE

Reduces eyestrain



YELLOW

Enhances flat-light terrain definition



CLEAR

Increases contrast in cloudy conditions



SMOKE

Cuts down brightness without color distortion



ROSE

Delivers superior low-light visibility

X7

509 SINISTER X7 SNOW GOGGLE



**QUICK CHANGE 5MAG
MAGNETIC LENS TECHNOLOGY**
SWAP OUT LENSES WITH EASE

NEW SINISTER X7 LENSES



FIRE ROSE	2833170
BLUE	2833171
YELLOW	2833172

CLEAR	2833173
SMOKE	2833174
ROSE	2833175

**5MAG FOR
POLARIS**

FEATURING EXCELLENT
VISIBILITY, ANTI-FOG
PERFORMANCE AND
DURABILITY

- 5MAG lens retention system is a magnetic lens technology for quick and easy lens changing on the go
- Soft goggle frame for unparalleled comfort and fit
- Hard lens frame insures an optimal fit and a great seal
- Over the glasses compatible
- Shuttered venting in frame scoop air in or closes off flow
- Easily replace lens for varying conditions
- Improved tints, low light, and contrast improving technologies including polarized, HCS, and photochromatic also available

NEW
RADIANT GREEN
2833055



LIGHT ROSE HCS TINT

BLACK/RED
2861477



FIRE MIRROR LIGHT ROSE

BLACK/LIME
2861479



YELLOW



KINGPIN

KINGPIN 509 SNOW GOGGLE



PREMIUM MATERIALS IN AN AFFORDABLE PACKAGE

- Oversized spherical lens delivers optimal peripheral vision
- Maximum anti-fog and scratch-resistant
- Contoured frame and triple-layer foam seals out cold and snow
- Removable nose piece delivers versatile cold-weather protection
- Quick-change lens technology for fast lens-tint swaps



QUICK-CHANGE LENS TECHNOLOGY
SWAP OUT LENSES WITH EASE

NEW
KINGPIN LENSES



CLEAR	2868547
YELLOW	2868548
CHROME	2868549
SMOKE	2868550

FIND THE PERFECT LENS FOR EVERY LIGHT CONDITION AT POLARIS.COM/SNOWGOGGLES

NEW
HEATED GLOVE LINER

- Keeps your hands warm on those frosty days
- Designed to fit under all Polaris riding gloves for an extra layer of warmth to keep you out riding longer
- Easily adjust your heat level by pressing a button on the bottom part of the glove

HEATING ELEMENT



UNISEX
S-3XL | 2833044



MEN'S
S-3XL | 2862480

TITAN

LEATHER GLOVE

- Durable glove with reinforced leather on palm for long-lasting wear and excellent control and feel
- 300g 3M® Thinsulate® Insulation on back of hand and 100g 3M® Thinsulate® Insulation on palm
- 3M® Scotchlite® Reflective Material for added safety in all weather conditions
- Built-in goggle wipe

INSULATION

PADDING

GRIP



NORTHSTAR

GLOVE

- Premium performance with rugged polyester and leather construction
- Reinforced leather palm provides excellent control and feel
- Men's zonal warmth of 250g of 3M® Thinsulate® on backside and 150g in palm
- Women's zonal warmth of 300g of 3M® Thinsulate® on backside and 150g in palm

INSULATION

PADDING

GRIP



WOMEN'S
S-3XL | 2861462

MEN'S
S-3XL | 2861461



APPAREL

MEN'S APPAREL

WOMEN'S APPAREL

YOUTH APPAREL

HELMETS

GOGGLES

GLOVES

BOOTS, BALACLAVAS,
& LUGGAGE

HOME & COLLECTIBLES



REVELSTOKE

GLOVE

- Reinforced leather palm for excellent control and feel
- Adjustable wrist strap seals out snow
- Dry-zone anti-slip insert
- 150g of 3M® Thinsulate® on back of hand
- Built-in goggle squeegee on backside of glove to keep vision clear
- Touchscreen compatible

INSULATION



PADDING



GRIP



MEN'S
S-3XL | 2861459

BOOTS & BALACLAVAS

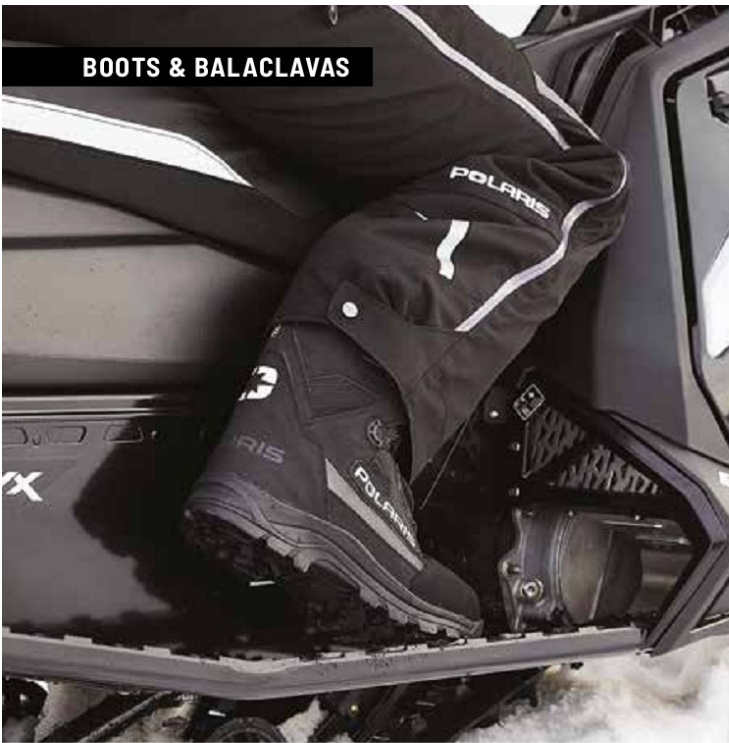

ICE LOCK® SOLE TECHNOLOGY



800G OF 3M® THINSULATE® INSULATION

BOA® LACING SYSTEM VS. LACES

Push to engage. Turn to tighten. Pull for quick release. The BOA® lacing system is easier to get on and off than traditional lace-up boots and gives a perfect fit with the turn of a knob. Even with gloves on.



SWITCHBACK 2.0 BOOT

PERFORMANCE, WARMTH AND COMFORT

\$347⁹⁹

- Waterproof and breathable TECH54 membrane keeps moisture out and allows perspiration to escape to keep your feet dry and comfortable
- 800g 3M® Thinsulate® Insulation helps provide warmth in cold weather
- Durable leather material
- BOA® lacing system
- Hypergrip outsole with IceLock provides better traction on wet and slippery surfaces

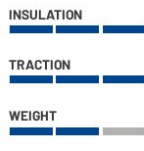

BLACK

Sizes: 5-14 | 2862481



MOUNTAIN BALACLAVA

- Laser-cut breath holes
- Windproof four-way stretch material blocks wind in key areas while providing extreme comfort

One Size | 2861474



TRAIL BALACLAVA

- Anti-fog neoprene nose guard
- Heavier windproof four-way stretch material blocks wind in key areas while providing extreme comfort

One Size | 2861475



OGIO
9800 RIG ROLLER

- SLED (Structural Load Equalizing Deck) system for increased durability and handling in the harshest of conditions
- Large main compartment with adjustable dividers and padded helmet chamber
- iFOM (Integrated foam) construction throughout for added gear protection
- Heavy-duty oversized wheels with extra clearance
- Telescoping pull handle
- Dimensions: 32"H x 16.5"W x 15.25"D

2861483

OGIO
CARRY-ON BAG

- Custom in-line skate wheels and locking retractable handles provide optimum mobility
- 2-stage Pullman handle
- Internal compression straps
- Airline regulation carry-on size with 3" expansion zipper
- Dimensions: 22"H x 14"W x 10"D

2861486

OGIO
**EXPLORER
BACKPACK**

- Easy-to-reach essential gear compartments and pockets
- Sewn-in EVA molded compartment that protects your fragile and valuable items
- Luggage handle pass-through for easy transport and mobility
- Dimensions: 19.5"H x 14"W x 1.5"D

2861485



HOME & COLLECTIBLES



RETRO CLOCK
12" | 2868662



POLARIS PARKING SIGN
2869934



ALUMINUM SIGN
22" | 2860867



WOODEN COASTERS
2860869



**RETRO GLASSES
(SET OF 2)**
2866265



**12oz
CAMPER MUG**
2861612



WOOD SIGN
10.5" x 24" | 2860866



**15oz
CAMPFIRE MUG**
2861613



PREMIUM KOOZIE
2860829



**LEATHER LOOP
KEYCHAIN**
2861615



KEYCHAIN
2861614



KICKBACK ROCKER
2862626



FREESTYLE ROCKER
2862625



EASY CHAIR
2862627



QUICK-E-SEAT
2862624



FOLDABLE TABLE
2861620



POP-UP TRASH BIN
2861622



FLASK
2860812



DECK OF CARDS
2860816



POLARIS
NORTHSTAR
COOLER

LEARN ABOUT OUR LINE OF POLARIS
NORTHSTAR COOLERS ONLINE AT
SNOWMOBILES.POLARIS.COM/NORTHSTARCOOLERS

APPAREL

MEN'S APPAREL

WOMEN'S APPAREL

YOUTH APPAREL

HELMETS

GOGGLES

GLOVES

BOOTS, BALACLAVAS,
& LUGGAGE

HOME & COLLECTIBLES

ACCESSORIES

YOUR ULTIMATE RIDE.

Make the best even better. Designed, engineered and tested to the same demanding standards as our snowmobiles, Polaris Engineered accessories perfectly complement how you ride. This means they fit perfectly, mount effortlessly, and perform to the highest standards in the backcountry, on the trail and everywhere in between.

ACCESSORY CONTENTS

82	Lock & Ride Flex	120	Customization
84	Connected Technology	122	Covers
86	MATRYX	124	Transport
96	AXYS	126	Traction & Control
112	PRO-RIDE	128	Tracks
118	Ride Readiness		





RIDER ACCESSORY COLLECTIONS

EXPLORE THE POSSIBILITIES

Introducing Rider Accessory Collections. Each item in these collections was carefully selected to elevate your riding experience with the accessories best suited for your riding style. Whether you're a trail, crossover, or mountain rider, explore the possibilities to take your ride to the next level.



TRAIL COLLECTION

2884456	Lock & Ride Flex Adventure Tunnel Bag - Tall	P. 87
2889776	Dash Storage Bag	P. 89
2889863	Auxiliary Punch Light	P. 90
2884815	Insight Side Mirrors	P. 92
2884937	Heated Driver Seat	P. 92
2889255	Adjustable Windshield	P. 94
2884817	Sentry Front Bumper	P. 95
2884979	Grill Inserts	P. 95

LEARN MORE ABOUT THE TRAIL COLLECTION AT SNOWMOBILES.POLARIS.COM/TRAILCOLLECTION



CROSSOVER COLLECTION

2889258	Burandt Bag - Medium	P. 87
2889733	Auxiliary Flood Light	P. 90
2884937	Heated Driver Seat	P. 92
2884815	Insight Side Mirrors	P. 92
2884616	Defend Handguards	P. 93
2884617	Defend Handguard Mounts	P. 93
2884933	Defend Handguard Signature Light	P. 93
2884816	Sentry Skid Plate	P. 107
2884817	Sentry Front Bumper	P. 107
2884257	Sentry Trail Rear Bumper	P. 107
2889142	Magnetic Tether	P. 118

LEARN MORE ABOUT THE CROSSOVER COLLECTION AT SNOWMOBILES.POLARIS.COM/CROSSOVERCOLLECTION



MOUNTAIN COLLECTION

2889259	Burandt Bag - Large	P. 87
2889322	Shovel Jacket	P. 87
2882823	Goggle Handlebar Bag	P. 89
2884816	Sentry Skid Plate	P. 95
2884817	Sentry Front Bumper	P. 95
2884979	Grill Inserts	P. 95
2889353	Sentry Mountain Rear Bumper	P. 95

LEARN MORE ABOUT THE MOUNTAIN COLLECTION AT SNOWMOBILES.POLARIS.COM/MOUNTAINCOLLECTION



LOCK & RIDE FLEX

WE REDEFINED ACCESSORY INTEGRATION
SO YOU CAN REDEFINE YOUR RIDE.

Lock & Ride Flex enables multiple configurations to easily add storage and passenger seating to your snowmobile in one simple click. Customize your configuration for the way you ride.



RETROFIT YOUR
SLED WITH
LOCK & RIDE FLEX



LOCK & RIDE FLEX ADAPTER KIT

AXYS PRO-RIDE

• Add Lock & Ride Flex storage to AXYS and Pro-Ride full tunnel sleds
2884939

ALL PRO-RIDE & AXYS SLEDS W/ TUNNEL T-SLOTS,
NOT COMPATIBLE WITH LOCK & RIDE FLEX M2 SEAT

EASY & SECURE

See how you can customize your Lock & Ride Flex Storage configuration for your tunnel length.

- Push to secure
- Lift to release
- No turning, no twisting

- Customizable configurations
- Retro-fit compatible

121" - 128" TUNNEL AND LONGER

SPORT TUNNEL BAG - LOW



1 SMALL

129" - 146" TUNNEL AND LONGER

ADVENTURE TUNNEL BAG - LOW



1 MEDIUM
OR
2 SMALL

155" TUNNEL AND LONGER

BURANDT BAG - LARGE



1 LARGE
OR
1 MEDIUM + 1 SMALL
OR
3 SMALL

SMALL

- 2884453 **LOCK & RIDE FLEX** Sport Tunnel Bag - Low
- 2884454 **LOCK & RIDE FLEX** Sport Tunnel Bag - Tall
- 2884957 **LOCK & RIDE FLEX** M2 Seat - Heated
- 2884725 **LOCK & RIDE FLEX** M2 Seat - Standard
- 2890008 **LOCK & RIDE FLEX** Waterproof Roll-Top Bag

MEDIUM

- 2884455 **LOCK & RIDE FLEX** Adventure Tunnel Bag - Low
- 2884456 **LOCK & RIDE FLEX** Adventure Tunnel Bag - Tall
- 2889258 **LOCK & RIDE FLEX** Burandt Bag - Medium*
- 2889228 **LOCK & RIDE FLEX** M2 Journey Bag
- 2890018 **LOCK & RIDE FLEX** Adventure Rack**

LARGE

- 2889259 **LOCK & RIDE FLEX** Burandt Bag - Large*

*Additional color options available.
** 136" tunnel and longer.

LEARN MORE AT
POLARIS.COM/LOCKRIDEFLEX

 **TRAIL TECH**





PIEPS® CARBON TOUR 260

Weight: 270g | 2884312

PIEPS® ALUMINUM 260

Weight: 300g | 2883678

PIEPS® IPROBE BT

- Optical and acoustic signal indicates an electronic "hit" within a 1m diameter to eliminate near misses and false strikes when probing, saving valuable time during a rescue.

Tubes	6
Tube diameter	12,5MM
Length	260CM
Weight	430G

2884969

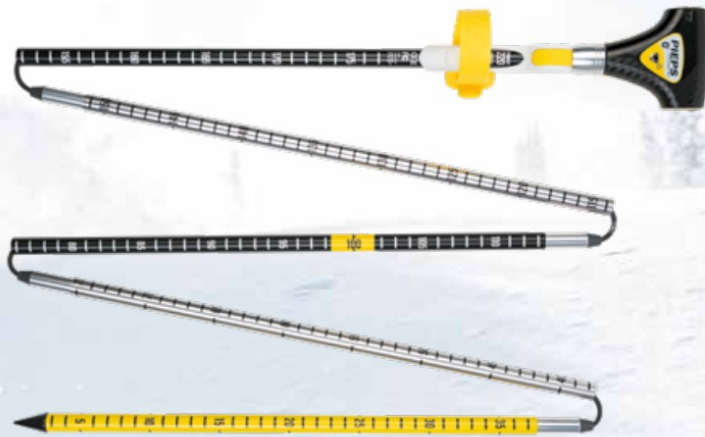

PIEPS® SHOVEL T 825 PRO+ WITH SAW BLADE

Blade dimensions	30,5 x 24, 4 x 4,5CM
Total weight	825G
Handle length	80CM

2883680





MATRYX

The rider-first MATRYX platform delivers instinctive, intuitive control with breakthrough rider dynamics and such seamless accessory integration that rider and machine become one. These accessories look, feel and function like integral elements of the sled.

RMK

MY22-23 MATRYX SLASH PRO RMK 155/163/165
 MY22-23 MATRYX SLASH RMK KHAOS 146/155/163/165
 MY22-23 MATRYX PRO RMK 155
 MY22-23 MATRYX RMK KHAOS 155
 MY23 SKS 146

SWITCHBACK

MY21-23 ASSAULT 146
 MY22-23 XC 146
 MY23 SWITCHBACK SP 146

VOYAGEUR

MY22-23 146

INDY

MY21 XC LAUNCH EDITION 129/137
 MY21-23 VRI 129/137
 MY22-23 XCR 128/136
 MY22-23 ADVENTURE/X2 137
 MY22-23 XC 129/137
 MY23 INDY SP 137



MATRYX - STORAGE



8.5 LITERS

LOCK & RIDE FLEX BURANDT BAG - MEDIUM MATRYX AXYS PRO-RIDE

- Compression molded, turtle shell design for enhanced weather resistance
- Oversized buckles provide easy access to gear with your gloves on
- Integrated mounts for shovel jacket enabling riders to carry a secondary shovel
- Installation on AXYS and Pro-Ride sleds requires the Lock & Ride Flex Adapter Kit (2884939), sold separately

NEW Carbon Print with Red Accents | 2889897
NEW Carbon Print with Blue Accents | 2890009
 Black | 2889258 **TOP SELLER**
 Liner Bag - Medium | 2889349
 ALL MATRYX 129 AND LONGER, ALL SNOWMOBILES 129 AND LONGER WITH FULL TUNNEL AND LOCK & RIDE FLEX ADAPTER KIT



15 LITERS

LOCK & RIDE FLEX BURANDT BAG - LARGE MATRYX AXYS PRO-RIDE

- Compression molded, turtle shell design for enhanced weather resistance
- Oversized buckles provide easy access to gear with your gloves on
- Integrated mounts for shovel jacket enabling riders to carry a secondary shovel
- Installation on AXYS and Pro-Ride sleds requires the Lock & Ride Flex Adapter Kit (2884939), sold separately

NEW Carbon Print with Red Accents | 2889900
NEW Carbon Print with Blue Accents | 2890010
 Black | 2889259 **TOP SELLER**
 Liner Bag - Large | 2889350
 ALL MATRYX 155 AND LONGER, ALL SNOWMOBILES 155 AND LONGER WITH FULL TUNNEL AND LOCK & RIDE FLEX ADAPTER KIT



SHOVEL JACKET MATRYX AXYS PRO-RIDE

- Provides a perfect location to bring a secondary shovel on your sled
- Attaches directly to lids of both Small and Large Lock & Ride Flex Burandt Tunnel Bags

Jacket | 2889322 **TOP SELLER**
 ALL SNOWMOBILES EQUIPPED WITH A LOCK & RIDE FLEX BURANDT BAG
 PIEPS® Shovel T 825 Pro+ With Saw Blade | 2883680
 ALL SNOWMOBILES



MATRYX - STORAGE



LOCK & RIDE FLEX SPORT TUNNEL BAG

MATRYX AXYS PRO-RIDE

- Semi-rigid design available in two profiles; fits great with M2 seat
- Oversized buckles provide easy access to gear with your gloves on
- Customizable configuration with Velcro® adjustable dividers

Low | 2884453
ALL MATRYX, ALL SNOWMOBILES EQUIPPED WITH LOCK & RIDE FLEX ADAPTER KIT



Liner Bag - Small
2889260



LOCK & RIDE FLEX ADVENTURE TUNNEL BAG

MATRYX AXYS PRO-RIDE

- Semi-rigid design available in two profiles
- Oversized buckles provide easy access to gear with your gloves on
- Customizable configuration with Velcro® adjustable dividers

Low | 2884455
ALL MATRYX, ALL SNOWMOBILES EQUIPPED WITH LOCK & RIDE FLEX ADAPTER KIT



Liner Bag - Small
2889262

- Base is water-resistant to keep your gear dry
- Installation on AXYS and Pro-Ride sleds requires the Lock & Ride Flex Adapter Kit (2884939), sold separately

Tall | 2884456 **★ TOP SELLER**
ALL MATRYX, ALL SNOWMOBILES EQUIPPED WITH LOCK & RIDE FLEX ADAPTER KIT



Liner Bag - Large
2889263



LOCK & RIDE FLEX M2 JOURNEY BAG

MATRYX AXYS PRO-RIDE

- Only requires one position when installed in the rear location on MATRYX INDY 137 and Switchback 146 snowmobiles
- Maximizes tunnel storage when the Lock & Ride Flex M2 Seat is installed on MATRYX INDY 137 and Switchback 146 snowmobiles
- Semi-rigid design and water-resistant base keeps your gear protected

2889228
ALL MATRYX, ALL SNOWMOBILES EQUIPPED WITH LOCK & RIDE FLEX ADAPTER KIT



NEW LOCK & RIDE FLEX WATERPROOF ROLL TOP BAG

MATRYX AXYS PRO-RIDE

- Completely waterproof to protect valuables
- Roll top design allows for quick and easy access

2890008
ALL MATRYX, ALL SNOWMOBILES 121 AND LONGER WITH FULL TUNNEL AND LOCK AND RIDE FLEX ADAPTER KIT



NEW LOCK & RIDE FLEX ADVENTURE RACK WITH SKI/ SNOWBOARD ATTACHMENT

MATRYX AXYS PRO-RIDE

- Get more out of your ride with the versatility of the Adventure Rack
- Add the Ski and Snowboard Attachment to the Adventure Rack for a fully integrated solution. Skiing and snowboarding has never been easier. Catch a ride to the top on your sled and bring all your gear to coast down
- Size medium - fits on tunnel lengths 136" and longer-use with size Small Lock & Ride Flex storage bags on 155" tunnels and longer

A Adventure Rack | 2890018
B Ski/Snowboard Attachment | 2890017

ALL MATRYX 136 AND LONGER, ALL SNOWMOBILES 136 AND LONGER WITH FULL TUNNEL AND LOCK AND RIDE FLEX ADAPTER KIT





2.7 LITERS

GOGGLE HANDLEBAR BAG MATRYX AXYS

- Conveniently access spare goggles from the driver's seat

2882823

ALL MATRYX, ALL AXYS



7.6 LITERS

GLOVE BOX LINER MATRYX

- Convenient, organized storage
- Features 4 separate compartments to keep your important items secure
- Compartments seamlessly line the storage area behind your display

2884753 ★ TOP SELLER

ALL MATRYX



NEW DASH STORAGE BAG MATRYX

- 100% waterproof, premium storage bag
- Features waterproof material and zipper access for convenient access and maximum protection of your valuables
- Fits seamlessly into the storage compartment behind your display

2889776

ALL MATRYX



8.5 LITERS

RMK ESSENTIALS BAG MATRYX

- Lock & Ride Flex storage can be added to the back of the RMK Essentials Bag
- Bag takes up a small position on the tunnel

2889257

ALL MATRYX RMK



11.8 LITERS

UNDERSEAT LINER BAG MATRYX

- Fits inside factory underseat compartment for waterproof storage

2884752

ALL MATRYX 129, 137, AND SBA 146



2 PAC

1.5" x 15' 5,500 LB. RATCHET STRAP 2000KG

- Keep your Snowmobile, ATV or Ranger safely strapped at your trailer.
- Dimension 3,5cm/ 50cm/ 550cm
- Max load 2000kg/ working load 1000kg
- 2 pac

POL05031

LIGHT UP THE NIGHT

When the days just aren't long enough, don't let the dark end your ride early. Our all-new Auxiliary Lighting options maximize your nighttime visibility so that you can ride confidently, no matter what time of day. Choose between the Punch Light option which provides better visibility further down the trail, or the Flood Light option for a wider range of vision close to your sled.



STOCK HEADLIGHT



NIGHTBLADE HEADLIGHT MATRYX

- Most Polaris MATRYX sleds come stock with this state of the art lighting technology
- Six projector beam optics deliver precision lighting with an engineered pattern to deliver exceptional visibility for night riding

ON ALL MODELS EXCEPT SKS 146, INDY SP, SWITCHBACK SP, VOYAGEUR 146

ACCESSORIZE IT



AUXILIARY PUNCH LIGHT MATRYX

- Additional 1,000 lumens per side for increased visibility
- Ride confidently with an increased distance illuminated
- Provides better visibility further down the trail

2889863
ALL MATRYX



AUXILIARY FLOOD LIGHT MATRYX

- Additional 1,000 lumens per side for increased visibility
- Ride confidently with a wider range of visibility close to your sled
- Provides better visibility to react to your surrounding terrain

2889733
ALL MATRYX

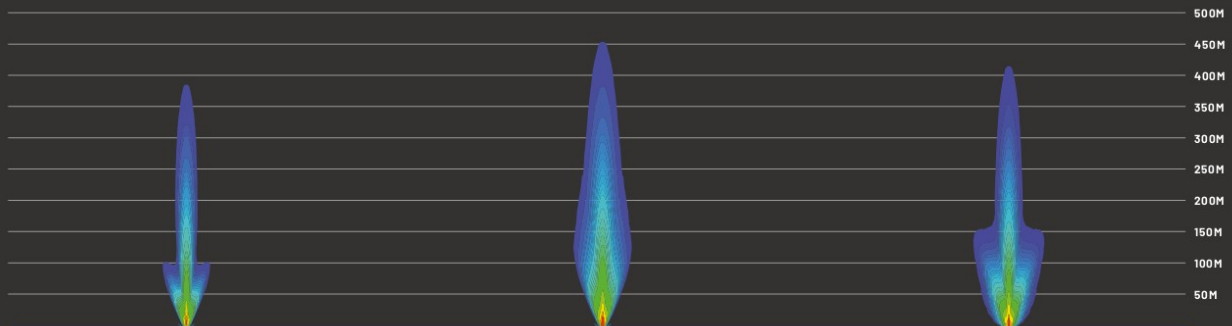

STANDARD HIGH BEAM



HIGH BEAM + AUXILIARY PUNCH

Best for wide open spaces & conditions requiring long distance visibility



HIGH BEAM + AUXILIARY FLOOD

Best for tight riding spaces or when you need a broad light

MATRYX - PASSENGER SEATING



ACCESSORIES

LOCK & RIDE FLEX

CONNECTED TECHNOLOGY

MATRYX

AXYS

PRO-RIDE

RIDE READINESS

CUSTOMIZATION

COVERS

TRANSPORT

TRACTION & CONTROL

TRACKS

LOCK & RIDE FLEX M2 SEAT MATRYX

- All-in-one passenger seating system in standard or heated version
 - Both versions come with heated grips
 - Heated M2 Seat adds additional comfort for your passenger by adding a heating element to the base of the seat
 - Not compatible with Lock & Ride Flex Adapter Kit
- Standard | 2884725

Heated | 2884957 TOP SELLER

ALL MATRYX 129, 137, AND SBA 146



M2 PASSENGER GAUNTLETS MATRYX

- Passenger gauntlets for the M2 Seat
- Made from compression molded nylon
- Utilizes faux fur lining to provide additional warmth to the passenger's hands

2889364

ALL MATRYX, REQUIRES M2 PASSENGER SEAT (2884725 OR 2884957). SOLD SEPARATELY



PASSENGER FOOTREST MATRYX

- Rugged extruded aluminum design adds passenger comfort and safety

2884813-067

ALL MATRYX 129, 137, AND SBA 146



NORDIC PRO CARGO BOX

- Cargo can also be stored on the lid with straps.

P271 Cargo box large

P272 Cargo box small (With 2-Up seat attached)



M2 SEAT STORAGE BAG MATRYX

- Semi-rigid design fits securely beneath accessory M2 seat leaving room for additional tunnel storage

2884956 | \$159⁹⁹

ALL MATRYX 129, 137, AND SBA 146. REQUIRES M2 PASSENGER SEAT (2884725 OR 2884957). SOLD SEPARATELY

REAR TORSION SPRING KITS MATRYX AXYS

CUSTOMIZE YOUR RIDE BASED ON TOTAL RIDER WEIGHT (COMBINED WEIGHT OF RIDER, GEAR AND/OR PASSENGER)

2884973 129/137 Light Duty

2884974 129/137 Heavy Duty

2884975 129/137 Extra Heavy Duty

ALL MATRYX/AXYS 129 & 137 SNOWMOBILES

2884976 144/146 Light Duty

2884977 144/146 Heavy Duty

ALL MATRYX SWITCHBACK ASSAULT 146, AXYS SWITCHBACK ASSAULT 144

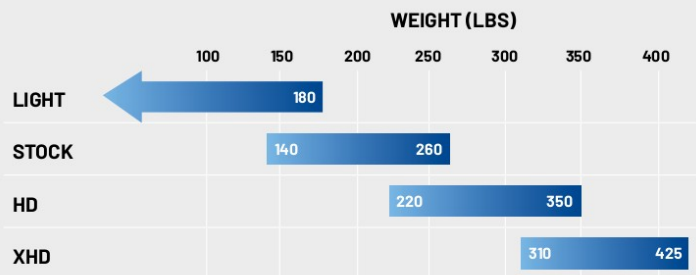

SEE MORE AT A GLANCE

Check your rearview quickly and stay focused on the ride with Insight Side Mirrors that integrate seamlessly into the cockpit—and never choose between handguards or mirrors again.

INSIGHT SIDE MIRRORS MATRYX

- Side-panel mount allows for use of handguards or gauntlets

2884815 * TOP SELLER
ALL MATRYX



RMK



TRAIL PERFORMANCE/
CROSSOVER

NEW ULTIMATE KNEE PADS MATRYX

- One pair of knee pads
- Provides protection to knees from bumps against the console
- High quality, durable foam construction for lasting quality

RMK | 2889944

ALL MATRYX RMK

Trail Performance/Crossover | 2889889

ALL MATRYX INDY, SWITCHBACK, AND VOYAGEUR



DRIVER GAUNTLETS MATRYX

- Premium nylon construction delivers protection from cold
- Clear poly panels allow for handlebar switch visibility
- Requires Defend Handguard Mounts (2884617) for install, sold separately

2884814

ALL MATRYX 129, 137, AND SBA 146



CONDUCTIVE HEAT

HEATED DRIVER SEAT MATRYX

- Features easy-to-use high/low/off switch for complete control
- Complete seat assembly with all mounting hardware and harness included

2884937

ALL MATRYX 129, 137, AND SBA 146

MATRYX - HANDLEBARS



ACCESSORIES

LOCK & RIDE FLEX

CONNECTED TECHNOLOGY

MATRYX

AXYS

PRO-RIDE

RIDE READINESS

CUSTOMIZATION

COVERS

TRANSPORT

TRACTION & CONTROL

TRACKS



RMK NARROW HANDLEBARS MATRYX

- Pro Taper handlebars with the same style as the factory handlebars
- Narrow RMK Handlebar has a reduced width (approximately 1.5 in narrower)
- Provides better control with precise steering
- More accurate hand heating from the heated handlebar grips

5" Rise	2889358
6" Rise	2889359
7" Rise	2889360

ALL MATRYX RMK, ALL AXYS RMK



NEW RMK HANDLEBAR ADJUSTABLE MOUNT MATRYX AXYS

- Get the perfect fit on your handlebars with the RMK Handlebar Adjustable Mount
- Reduce the strain on your body with a more natural and effortless feel
- Ride easy knowing that your grip is firm and your arms are stable

2889867
ALL MATRYX AND AXYS RMK



NEW RMK BACKCOUNTRY HAND GUARDS MATRYX AXYS

- Provides the ultimate protection for your hands
- Sold in pairs
- Mounts included

2889868
ALL MATRYX AND AXYS RMK



* TOP SELLER DEFEND HANDGUARDS MATRYX

- Oversized design offers increased protection and warmth; factory-color-matched

■ Gloss Black	2884616-266
■ Indy Red	2884616-293
□ White	2884616-599

ALL MATRYX. DOES NOT WORK WITH MID OR TALL WINDSHIELD
REQUIRES DEFEND HANDGUARD MOUNTS, SOLD SEPARATELY



* TOP SELLER DEFEND HANDGUARD SIGNATURE LIGHT MATRYX

- Elevated customization with signature accent lighting for handguards

2884933
ALL MATRYX
REQUIRES DEFEND HANDGUARDS & DEFEND HANDGUARD MOUNTS, EACH SOLD SEPARATELY

DEFEND HANDGUARD MOUNTS MATRYX

- Made of durable and strong, yet flexible injection molded plastic

Mounts are required to install Defend Handguards
2889305
ALL MATRYX RMK
2884617
ALL MATRYX 128, 129, 137, AND SBA 146

MATRYX - WINDSHIELDS

23"-27"
TALL

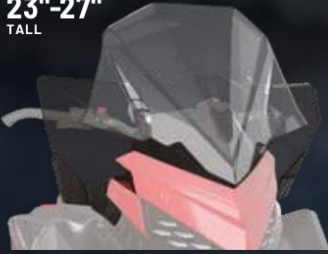

NEW
EXTRA LARGE ADJUSTABLE WINDSHIELD MATRYX

✕ Clear 2889865

ALL MATRYX DOES NOT WORK WITH HANDGUARDS

20"-24"
TALL

ADJUSTABLE WINDSHIELD MATRYX

✕ Clear 2889255

ALL MATRYX

FIND THE RIGHT WINDSHIELD FOR YOU

Easily modify to your desired level of wind protection with the adjustable windshield, or find the right windshield built for the type of riding you do most.



FULL COVERAGE WINDSHIELD

TALL WINDSHIELD

ADJUSTABLE WINDSHIELD

DEEP SNOW LOW WINDSHIELD



BEZEL MATRYX

■ Gloss Black	2884936-266
■ Indy Red	2884936-293
■ Orange Burst	2884936-647
■ Sky Blue	2884936-737
■ Polaris Blue	2884936-751
■ Plum Crazy NEW	2884936-784
■ Neon NEW	2884936-801

ALL MATRYX

23"
TALL

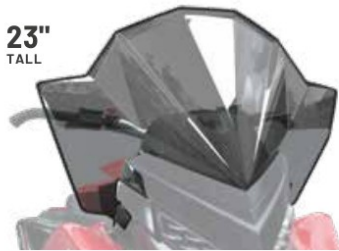

TALL WINDSHIELD MATRYX

■ Smoke 2884935

ALL MATRYX

15"
TALL



DEEP SNOW LOW WINDSHIELD MATRYX

■ Dark Smoke 2889405

ALL MATRYX

20"
TALL

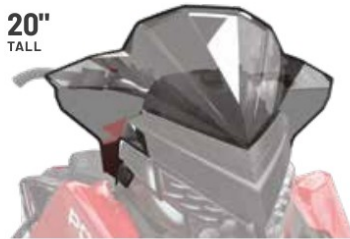

MID WINDSHIELD MATRYX

■ Smoke 2884934

ALL MATRYX

24"
TALL



EXTRA TALL WINDSHIELD MATRYX

✕ Clear 2885128

ALL MATRYX

25"
TALL

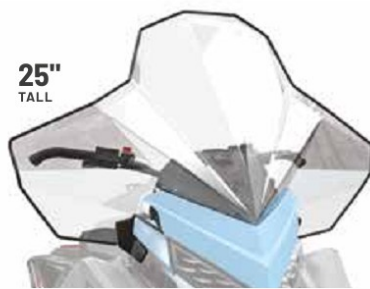

FULL COVERAGE WINDSHIELD MATRYX

✕ Clear 2889256

ALL MATRYX

MATRYX - PROTECTION

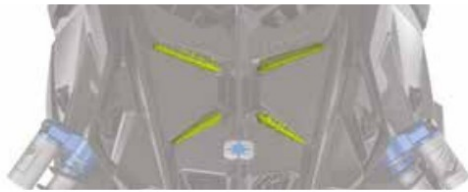

★ TOP SELLER

GRILL INSERTS MATRYX

■ Gloss Black	2884979-067
■ Indy Red	2884979-293
■ Orange Burst	2884979-647
■ Sky Blue	2884979-737
■ Polaris Blue	2884979-751
■ Plum Crazy NEW	2884979-784
■ Neon NEW	2884979-801
■ Stealth Gray	2884979-804
■ Radiant Green NEW	2884979-887

ALL MATRYX



SENTRY TRAIL REAR BUMPER MATRYX AXYS

■ Gloss Black	2884257-067
□ Bright White	2884257-133
■ Indy Red	2884257-293
■ Turbo Silver	2884257-402
■ Orange Burst	2884257-647
■ Velocity Blue	2884257-689
■ Sky Blue	2884257-737
■ Polaris Blue	2884257-751
■ Stealth Gray	2884257-804

ALL AXYS & MATRYX 129, 137, AND 144/146 SWITCHBACK ASSAULT

★ TOP SELLER

SENTRY FRONT BUMPER MATRYX

■ Gloss Black	2884817-067
□ Bright White	2884817-133
■ Indy Red	2884817-293
■ Turbo Silver	2884817-402
■ Orange Burst	2884817-647
■ Sky Blue	2884817-737
■ Polaris Blue	2884817-751
■ Plum Crazy NEW	2884817-784
■ Neon NEW	2884817-801
■ Stealth Gray	2884817-804
■ Radiant Green NEW	2884817-887

ALL MATRYX

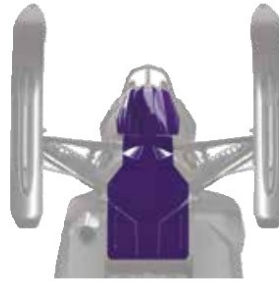

★ TOP SELLER

SENTRY SKID PLATE MATRYX

■ Black	2884816-070
□ Bright White	2884816-133
■ Indy Red	2884816-293
■ Polaris Blue	2884816-751
■ Plum Crazy NEW	2884816-784
■ Neon NEW	2884816-801

ALL MATRYX



SENTRY MOUNTAIN REAR BUMPER MATRYX

	146"	155" SLASH	155"/163"/165"
■ Gloss Black*	2889351-067	2889352-067	2889353-067
■ Indy Red	2889351-293	2889352-293	2889353-293
■ Turbo Silver	2889351-402	2889352-402	2889353-402
■ Orange Burst	2889351-647	2889352-647	2889353-647
■ Sky Blue	2889351-737	2889352-737	2889353-737
■ Polaris Blue	2889351-751	2889352-751	2889353-751
■ Plum Crazy NEW	2889351-784	2889352-784	2889353-784
■ Neon NEW	2889351-801	2889352-801	2889353-801
■ Stealth Gray	2889351-804	2889352-804	2889353-804
■ Radiant Green NEW	2889351-887	2889352-887	2889353-887

146" FITMENT: ALL MATRYX RMK KHAOS 146
 155" SLASH FITMENT: ALL MATRYX SLASH RMK 155
 155"/164" FITMENT: ALL MATRYX RMK 155/165 SLASH
 *STOCK ON SLEDS

ACCESSORIES

LOCK & RIDE
FLEX

CONNECTED
TECHNOLOGY

MATRYX

AXYS

PRO-RIDE

RIDE
READINESS

CUSTOMIZATION

COVERS

TRANSPORT

TRACTION
& CONTROL

TRACKS



AXYS

The proven AXYS platform delivers rider-balanced control and unrivaled acceleration. Our comprehensive collection of accessories includes everything needed to customize your sled's style, storage, comfort and protection to truly make it your own.

RUSH[®]

MY15-20 RUSH

RMK

MY16-22 AXYS PRO RMK
MY16-21 SKS
MY16-19 ASSAULT
MY20-22 AXYS KHAOS

SWITCHBACK

MY15-MY21 PRO-S/PRO-X/XCR
MY17-21 ASSAULT
MY17-19 SP

VOYAGEUR

MY17-21 600

INDY

MY19-21 XC 129
MY20-21 ADVENTURE/XC 137
MY20-21 XCR

TITAN

MY18-21 SP
MY18-22 XC
MY18-23 ADVENTURE

AXYS - STORAGE



ACCESSORIES

LOCK & RIDE FLEX

CONNECTED TECHNOLOGY

MATRIX

AXYS

PRO-RIDE

RIDE READINESS

CUSTOMIZATION

COVERS

TRANSPORT

TRACTION & CONTROL

TRACKS



LOCK & RIDE FLEX BURANDT BAG - MEDIUM

MATRIX AXYS PRO-RIDE

- Compression molded, turtle shell design for enhanced weather resistance
- Oversized buckles provide easy access to gear with your gloves on
- Integrated mounts for shovel jacket enabling riders to carry a secondary shovel
- Installation on AXYS and Pro-Ride sleds requires the Lock & Ride Flex Adapter Kit (2884939), sold separately

NEW Carbon Print with Red Accents | 2889897
NEW Carbon Print with Blue Accents | 2890009

Black | 2889258 **TOP SELLER**

Liner Bag - Medium | 2889349

ALL MATRIX 129 AND LONGER, ALL SNOWMOBILES 129 AND LONGER WITH FULL TUNNEL AND LOCK & RIDE FLEX ADAPTER KIT



LOCK & RIDE FLEX BURANDT BAG - LARGE

MATRIX AXYS PRO-RIDE

- Compression molded, turtle shell design for enhanced weather resistance
- Oversized buckles provide easy access to gear with your gloves on
- Integrated mounts for shovel jacket enabling riders to carry a secondary shovel
- Installation on AXYS and Pro-Ride sleds requires the Lock & Ride Flex Adapter Kit (2884939), sold separately

NEW Carbon Print with Red Accents | 2889900
NEW Carbon Print with Blue Accents | 2890010

Black | 2889259 **TOP SELLER**

Liner Bag - Large | 2889350

ALL MATRIX 155 AND LONGER, ALL SNOWMOBILES 155 AND LONGER WITH FULL TUNNEL AND LOCK & RIDE FLEX ADAPTER KIT



SHOVEL JACKET

MATRIX AXYS PRO-RIDE

- Provides a perfect location to bring a secondary shovel on your sled
- Attaches directly to lids of both Small and Large Lock & Ride Flex Burandt Tunnel Bags

2889322 **TOP SELLER**

ALL SNOWMOBILES EQUIPPED WITH A LOCK & RIDE FLEX BURANDT BAG

Pieps® Shovel T 825 PRO+ With saw blade | 2883680



AXYS - STORAGE

RETROFIT YOUR SLED WITH LOCK & RIDE FLEX

LOCK & RIDE FLEX ADAPTER KIT

AXYS PRO-RIDE

- Add Lock & Ride Flex storage to AXYS and Pro-Ride full tunnel sleds

2884939 **TOP SELLER**

ALL PRO-RIDE & AXYS SLEDS W/ TUNNEL T-SLOTS.
NOT COMPATIBLE WITH LOCK & RIDE FLEX M2 SEAT

10
LITERS

LOW

TALL

15
LITERS

23
LITERS

LOW

TALL

35
LITERS

LOCK & RIDE FLEX SPORT TUNNEL BAG

MATRYX AXYS PRO-RIDE

Low | 2884453

ALL MATRYX, ALL SNOWMOBILES EQUIPPED WITH LOCK & RIDE FLEX ADAPTER KIT



Liner Bag - Small
2889260

Tall | 2884454

ALL MATRYX, ALL SNOWMOBILES EQUIPPED WITH LOCK & RIDE FLEX ADAPTER KIT



Liner Bag - Large
2889261

LOCK & RIDE FLEX ADVENTURE TUNNEL BAG

MATRYX AXYS PRO-RIDE

Low | 2884455

ALL MATRYX, ALL SNOWMOBILES EQUIPPED WITH LOCK & RIDE FLEX ADAPTER KIT



Liner Bag - Small
2889262

Tall | 2884456 **TOP SELLER**

ALL MATRYX, ALL SNOWMOBILES EQUIPPED WITH LOCK & RIDE FLEX ADAPTER KIT



Liner Bag - Large
2889263

LOCK & RIDE FLEX ADVENTURE RACK WITH SKI/ SNOWBOARD ATTACHMENT

MATRYX AXYS PRO-RIDE

- Get more out of your ride with the versatility of the Adventure Rack
- Add the Ski and Snowboard Attachment to the Adventure Rack for a fully integrated solution. Skiing and snowboarding has never been easier. Catch a ride to the top on your sled and bring all your gear to coast down
- Size medium - fits on tunnel lengths 136" and longer-use with size Small Lock & Ride Flex storage bags on 155" tunnels and longer

A Adventure Rack | 2890018

B Ski/Snowboard Attachment | 2890017

ALL MATRYX 136 AND LONGER,
ALL SNOWMOBILES 136 AND LONGER WITH FULL TUNNEL
AND LOCK AND RIDE FLEX ADAPTER KIT

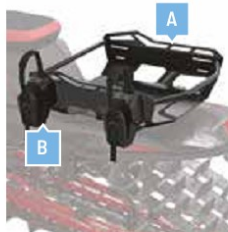

LOCK & RIDE FLEX WATERPROOF ROLL TOP BAG

MATRYX AXYS PRO-RIDE

- Our highest level of moisture resistance, built to protect your valuables
- Roll top design allows for quick and easy access

2890008

ALL MATRYX,
ALL SNOWMOBILES 121 AND LONGER WITH FULL
TUNNEL AND LOCK AND RIDE FLEX ADAPTER KIT



7.7
LITERS

BURANDT ADVENTURE UNDERSEAT BAG AXYS

- Dual side-access zippers provide access to cargo when bag is installed

2881056

HY16-21 AXYS PRO-RMK, AXYS SKS, AXYS RMK ASSAULT



10.8
LITERS

UNDERSEAT JOURNEY BAG AXYS

- Front of bag attaches behind seat using Tufflok® fasteners (included)
- Center cargo compartment and two side compartments
- Durable, semi-rigid compression-molded design resists impacts

2880372

AXYS RUSH AND SWITCHBACK, DOES NOT WORK WITH SWITCHBACK ASSAULT



4
LITERS

5
LITERS

WINDSHIELD BAG **AXYS**

- Bag installs inside base of windshield using stock push-dart fasteners
- Compression-molded semi-rigid material
- Engine heat warms/dries goggles and gloves

A Low Pro | 2880481

Large | 2880374

ALL AXYS



9.8
LITERS

B MOUNTAIN DASH BAG **AXYS**

- Convenient storage for two bottles of water, goggles, gloves, or anything else you need easy access to

2880375

AXYS PRO-RMK MY16-22, SKS 155 MY16-21, RMK ASSAULT MY16-20



5.8
LITERS

HEATED UNDERHOOD STORAGE **AXYS**

- Underhood storage is ideal for storing goggles and keeping them defrosted

2882117

ALL AXYS. DOES NOT FIT
POLARIS TITAN OR WITH
850 ENGINE



2.7
LITERS

HANDLEBAR MAP BAG **MATRYX** **AXYS** **PRO-RIDE**

- Clear poly window displays trail map for easier navigation
- Attaches easily with all-weather Velcro® strips

2882824

ALL SNOWMOBILES



A

B

C



2.7
LITERS

C GOGGLE HANDLEBAR BAG **MATRYX** **AXYS**

- Conveniently access spare goggles from the driver's seat

2882823

ALL MATRYX, ALL AXYS



46.4
LITERS

ADVENTURE TUNNEL BAG 1.0 **AXYS** **PRO-RIDE**

- 2" buckles make it easy to access your gear with gloves on
- Includes two waterproof duffels to easily bring gear inside after the ride
- Ample storage space to carry everything you need

2882816

ALL INDY 129, INDY 137, SBA 144, PRO-RMK



ADVENTURE TUNNEL BAG LINER

- Provides secure, waterproof storage for gear
- Features a waterproof zipper
- Has a large handle for convenient carrying

2889114

ALL ADVENTURE TUNNEL BAG 1.0 (2882816) EQUIPPED SNOWMOBILES

AXYS - RACKS



NEW LOCK & RIDE

RMK CARGO RACK **AXYS** **PRO-RIDE**

Cargo Box RMK 155" | P285
Cargo Box RMK 144" | P286

CARGO BOX VOYAGEUR 155 **AXYS** **PRO-RIDE**

P261

INDY 550 VOYAGEUR 155 15-16 155",
15-16, 2017-2018 WITH CARGO RACK 288275 INSTALLED

P288

VOYAGEUR 600 144" 2017-2021 (NOT IN PICTURE)

P294

550LXT 144" -2021, SWB 144" (WITH CARGO RACK 2881940-458 INSTALLED,
(NOT IN PICTURE))



15

LBS STORAGE

REAR SPORT RACK **AXYS**

- Versatile cargo-carrying solution
- Easy bolt-on installation; all mounting hardware included
- Lets you add the Sport Rack Bag (2881464) sold separately. The Sport Rack can remain on the sled when the bag is removed

RUSH | Matte Black

2880362-458

ALL AXYS RUSH

SWITCHBACK | Matte Black

2880363-458

ALL AXYS 137 PRO-S

CARGO RACK 144" **AXYS** **PRO-RIDE**

- Design offers three-level storage with low, medium and high cross bars
- Angled design accommodates tie-down straps to secure cargo
- Fits P294 Cargo box

Matte Black | 2881940-458

ALL AXYS, PRO-RIDE 144

SPORT RACK BAG **AXYS**

- Bag attaches behind seat using Tuflok® fasteners
- Durable, semi-rigid compression-molded design resists impacts
- Requires Rear Sport Rack (2880362-458 or 2880363-458), sold separately

2881464

AXYS RUSH & SWITCHBACK,
DOES NOT WORK WITH SWITCHBACK ASSAULT



15.6
LITERS

CARGO BAG 144" **AXYS** **PRO-RIDE**

- Semi-compressed with nylon side bag installs securely in cargo rack
- Versatile bag can be converted to a single large-cargo compartment

2881968

MY17-21 AXYS 144, MY18-21 SKS 146,
ALL 550 AND 600 VOYAGEUR MODELS
REQUIRES CARGO RACK 144" (2881940-458),
SOLD SEPARATELY





J- HITCH

- J-Hitch can be mounted on all snowmobile units from MY 1998-2023.
- Mounts for each model of snowmobile are listed to the right
- and are available in black color.
- More mounts can be purchased just contact your local dealer for hitch to your model of snowmobile.

B0221

- B0130 J-Hitch Widetrack GT/ LX/ IQ
- B0131 J-Hitch TITAN Safety, 4-Bolt
- B0221 J- Hitch | MY 1989-2021
- B0255 K-Mount 600/800 INDY XC 129" | MY 2019 - 2020
- B0255 K-Mount 650/ 850 VR1/ INDY XC 129" MATRYX -22
- B0256 K-Mount 600/850 INDY XC137" | MY 20-23
- B0256 K-Mount 650/ 850 VR1/ INDY XC 137" MATRYX MY 2021-23
- B0256 K-Mount 650/ 850 XCR 136" MATRYX 21-23
- B0254 K-Mount 650/ 850 Switchback 146" MATRYX MY 21-23
- B0251 K-Mount AXYS RMK & SKS 155" | MY 16-21
- B0254 K-Mount AXYS SKS 146" 600/800 Switchback Assault 144" and 800 Switchback SP 144" | MY -2019



- B0254 K-Mount 850 Switchback Boost 146" 2023
- B0252 K-Mount AXYS SWB Assault/ SP 144", SKS 146" | MY -18
- B0246 K-Mount RMK 155" | MY 12-15
- B0248 K-Mount INDY Voyageur 550 14, 550 Adventure X2 | MY 14-16
- B0245 K-Mount 600 INDY VOYAGER | MY 14 - 16
- B0236 K-Mount IQ 121" 08-2012, IQ SWB 136" | MY 08-10
- B0245 K-Mount Switchback 144" | MY 11-15
- B0244 K-Mount INDY 121", INDY EVO | MY 19-20
- B0236 K-Mount 550IQ LXT Touring | MY 11-13
- B0249 K-Mount 550 INDY VOYAGER | MY 15-16
- B0249 K-Mount 550 INDY Adventure | MY 15-16

AXYS - PASSENGER SEATING

LOCK & RIDE

FT2 PASSENGER SEAT **AXYS**

- Includes backrest, seat and handholds
- Heated grips and plug-in for passenger's heated visor
- Installs/removes easily with Lock & Ride technology
- Requires FT2 Rear Seat Rack (2883646), sold separately

Standard | 2883637

ALL AXYS INDY FULL TUNNEL SNOWMOBILES,
AND AXYS SWITCHBACK ASSAULT

Heated  | 2884208

ALL AXYS INDY FULL TUNNEL SNOWMOBILES,
AND AXYS SWITCHBACK ASSAULT

LOCK & RIDE

FT2 REAR SEAT RACK **AXYS**

- Attaches via Lock & Ride technology
- Made of powder-coated high-quality steel

2883646

ALL AXYS INDY FULL TUNNEL SNOWMOBILES,
AND AXYS SWITCHBACK ASSAULT



FT2 UNDER-RACK BAG **AXYS**

- Easy access with weather-resistant zipper
- Compression-molded design provides rigidity
- Attaches directly to rack with water-resistant Velcro®

2883714

ALL AXYS INDY FULL TUNNEL SNOWMOBILES,
AND AXYS SWITCHBACK ASSAULT



NEW

CARGO BOX FT2 2-UP-SEAT

- Cargo Box FT2 2-Up seat 144" - 155" AXYS
(Can not be used with 2883714 Under seat bag.)
- P287



HAND-WARMER POWER KIT MATRYX AXYS

• Required to power the passenger hand-warmers on MY17-18 AXYS 144 sleds
2883851
 ALL MY18 AXYS 600/800 137 & 144 SWITCHBACK ASSAULT



LOCK & RIDE
FLEX

CONNECTED
TECHNOLOGY

MATRYX

AXYS

PRO-RIDE

RIDE
READINESS

CUSTOMIZATION

COVERS

TRANSPORT

TRACTION
& CONTROL

TRACKS



PASSENGER FOOTRESTS MATRYX AXYS

- Add passenger comfort and security with passenger footrests
- Extruded aluminum design attaches directly to running board

SWITCHBACK 137 | **2882817**

AXYS SWITCHBACK

AXYS 129/137/144 | **2883571**

MY19-21 AXYS INDY XC 129, MY17-21 SWITCHBACK ASSAULT 144



PASSENGER GAUNTLETS MATRYX AXYS

All 1+1 Seat | **2883573**
 ALL AXYS 1+1 SEAT

REAR TORSION SPRING KITS MATRYX AXYS

CUSTOMIZE YOUR RIDE BASED ON TOTAL RIDER WEIGHT
 (COMBINED WEIGHT OF RIDER, GEAR AND/OR PASSENGER)

2884973	129/137 Light Duty
2884974	129/137 Heavy Duty
2884975	129/137 Extra Heavy Duty

ALL MATRYX/AXYS 129 & 137 SNOWMOBILES

2884976	144/146 Light Duty
2884977	144/146 Heavy Duty

ALL MATRYX SWITCHBACK ASSAULT 146, AXYS SWITCHBACK ASSAULT 144

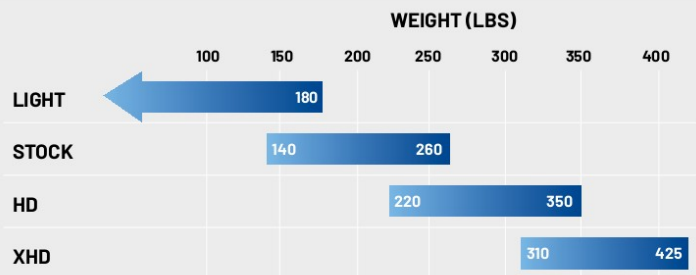

AXYS - RIDER COMFORT



HEATED SEAT **AXYS**

- Features easy-to-use high/low/off switch for complete control
- Complete seat assembly with all mounting hardware and harness included

Black | 2882819

ALL AXYS 120 - 146 SNOWMOBILES



XL HANDGUARDS

- Oversized for increased wind protection
- Durable, compression-molded design
- Mounts included

2884258

ALL SNOWMOBILES



POLARIS HANDGUARDS

- Durable, impact-resistant plastic
- Requires Handguard Mounts, sold separately

Black **★ TOP SELLER** 2879192

Red 2879193

White 2879194

ALL SNOWMOBILES
REQUIRES HANDGUARD MOUNTS,
SOLD SEPARATELY



DRIVER GAUNTLETS **AXYS**

- Premium nylon construction delivers protection from cold
- Clear poly panels allow for handlebar switch visibility

2883716

ALL AXYS

HANDGUARD MOUNTS **AXYS**

- Strong mounts ensure proper handguard installation
- Easy install: mounts directly onto handlebar

2880939

ALL AXYS 120 - 146 SNOWMOBILES, ALL TITAN

RMK HANDGUARD MOUNTS **AXYS**

- Strong mounts ensure proper handguard installation
- Installs securely on any ProTaper® handlebar

2881241-458

ALL AXYS RMK

AXYS - HANDLEBARS



ACCESSORIES

LOCK & RIDE
FLEX

CONNECTED
TECHNOLOGY

MATRIX

AXYS

PRO-RIDE

RIDE
READINESS

CUSTOMIZATION

COVERS

TRANSPORT

TRACTION
& CONTROL

TRACKS

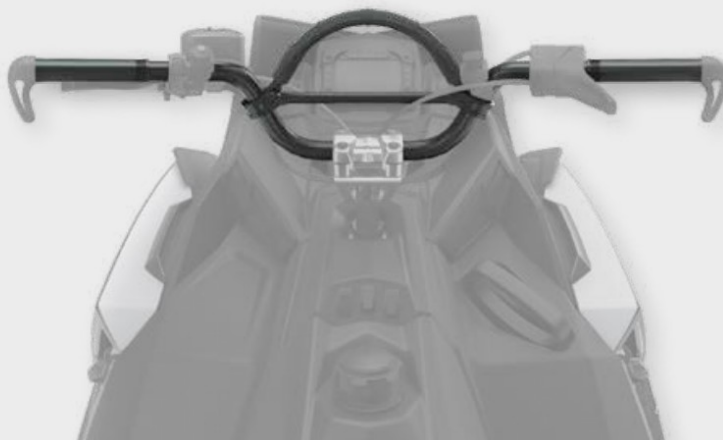

PROTAPER® HANDLEBAR WITH HEATED GRIPS **AXYS**

- ProTaper® handlebar allows riders to customize their handlebar height for their riding style
- Handlebar hooks (1823339-070), sold separately
- These handlebars were offered in SnowCheck features and options. Explore the lineup of various sizes to change your fit

5" Rise	Black	2881235
6" Rise	Anodized Gray	2881236
7" Rise	Silver	2881237

ALL AXYS 800 PRO-RMK'S

5" Rise	Black	2883835
6" Rise	Anodized Gray	2883836
7" Rise	Silver	2883837

ALL 850 - SKS 155 '19-20, RMK KHAOS '20, PRO-RMK '19-20, PRO RMK 163 '19-20, PRO RMK 155 '19-20



MOUNTAIN HOOP **AXYS**

2882118
ALL AXYS 120 - 146 SNOWMOBILES,
ALL TITAN



ROX® ADJUSTABLE BAR RISER **AXYS**

• Increase handlebar height from 2.5" to 4"
2881410
ALL AXYS 120 - 146 SNOWMOBILES, ALL TITAN



HANDLEBAR HOOK

2872482-070
DOES NOT FIT PROTAPER® BARS



MIRRORS **AXYS**

- Wide-angle view
- Non-fogging glass
- Folding design for use with cover
- Includes mounting hardware
- Sold as a pair

2880292 **★ TOP SELLER**
ALL AXYS

AXYS - WINDSHIELDS



DEEP SNOW MID WINDSHIELD

7" TALL



LOW WINDSHIELD AXYS

Black/Gray	2880385
White/Black	2880386
Red/White	2880387
Blue/White	2881244
Orange/Black	2881245
White	2882062

ALL AXYS

13" TALL

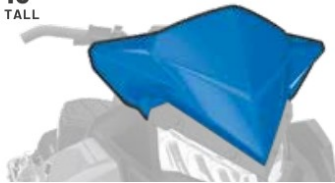

DEEP SNOW MID WINDSHIELD AXYS

Blue	2881053
White	2881054
Matte Black	2881055
Gloss Black	2882058

ALL AXYS

18" TALL



FLATLAND MID WINDSHIELD AXYS

Clear with Graphic	2880389
Gloss Black	2880390
White	2880391

ALL AXYS

20" TALL



TALL WINDSHIELD AXYS

Smoke <small>★ TOP SELLER</small>	2880394
-----------------------------------	---------

ALL AXYS

24" TALL

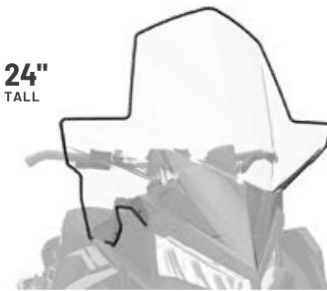

EXTRA TALL WINDSHIELD AXYS

Clear	2883078
-------	---------

ALL AXYS

25" TALL



FULL COVERAGE WINDSHIELD AXYS

Clear	2882796
-------	---------

ALL AXYS

AXYS - PROTECTION

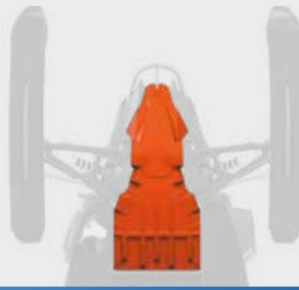

PROTECTION: MAXIMUM

MEDIUM

HIGH COVERAGE AXYS

- Provides the greatest amount of underbelly protection
- Rugged and lightweight UHMW material
- Note that this may hinder deep-snow performance
- Includes all mounting hardware

■ Black 2882748-070

ALL AXYS

ULTIMATE AXYS

- Extended length delivers extra protection for belly pan and bulkhead
- Includes all mounting hardware

■ Black <small>★ TOP SELLER</small>	2880383-070
□ Bright White	2880383-133
■ Indy Red	2880383-293
■ Blue	2880383-619
■ Orange Burst	2880383-647

ALL AXYS

EXTREME AXYS

- Enhances protection of belly pan and bulkhead
- Includes all mounting hardware

■ Black	2880384-070
□ Bright White	2880384-133
■ Indy Red	2880384-293

ALL AXYS



MONARCH AXYS

□ Bright White	2883681-133
■ Indy Red	2883681-293
■ Matte Black <small>★ TOP SELLER</small>	2883681-458
■ Orange Burst	2883681-647
■ Velocity Blue	2883681-689
■ Matte Gold Metallic	2883681-703
■ Sky Blue	2883681-737

ALL AXYS



EXTREME 144" | 155"/163" AXYS

	144"	155"/163"
□ Bright White	--	2880993-133
■ Indy Red	--	2880993-293
■ Matte Black	--	2880993-458
■ Velocity Blue	2881941-689	2880993-689
■ Matte Gold Metallic	2881941-703	2880993-703
■ Sky Blue	2881941-737	2880993-737

144" FITMENT: ALL AXYS 144, AXYS 146
155"/163" FITMENT: ALL AXYS 165, AXYS 163



ELITE PRO AXYS

■ Matte Black	2882926-458
■ Orange Burst	2882926-647

ALL AXYS RUSH, AND AXYS SWITCHBACK PRO-S



SENTRY TRAIL REAR BUMPER MATRIX AXYS

■ Gloss Black	2884257-067
□ Bright White	2884257-133
■ Indy Red	2884257-293
■ Turbo Silver	2884257-402
■ Orange Burst	2884257-647
■ Velocity Blue	2884257-689
■ Sky Blue	2884257-737
■ Polaris Blue	2884257-751
■ Stealth Gray	2884257-804

ALL AXYS & MATRIX 129, 137, AND 144/146 SWITCHBACK ASSAULT



AXYS - TITAN



HD FRONT BUMPER

- Add protection to the front of your TITAN with the HD Front Bumper with integrated front-facing winch mount
- Constructed from high-strength steel and finished in black powder coat

Black | 2882794
ALL TITAN



PRO ARMOR 11" SINGLE-ROW LED LIGHTS

Flood | 2882313
ALL TITAN
REQUIRES TITAN LIGHTBAR MOUNT (2882815), SOLD SEPARATELY

Spot | 2882078
ALL TITAN
REQUIRES TITAN LIGHTBAR MOUNT (2882815), SOLD SEPARATELY



110
LITERS

SCANDI BOX

- Largest storage option for TITAN with 110 liters of capacity
- Molded to fit seamlessly with the Versa Rear Cargo Rack
- Cargo can also be stored on the lid with straps.

P282
ALL TITAN



TITAN LIGHTBAR MOUNT

- This lightbar mount integrates with the HD Front Bumper so you'll be able to light your way no matter what you're getting into
- Recommended with Pro Armor® 11" Single Row - LED Flood Light (2882313) or Pro Armor® 11" LED Spot Light (2882078), sold separately

2882815
ALL TITAN



INTEGRATED 1,500LB WINCH

- Versatile and rugged winch can clear downed trees or retrieve a stuck snowmobile
- Features a powerful 1,500lb capacity
- Includes wireless winch remote
- Mounts to rear of sled with included receiver hitch
- Mounts to front of sled when using HD Front Bumper (Requires 2883850, sold separately)

2882798
ALL TITAN

TITAN FRONT WINCH ATTACHMENT CABLE

- Required for utilization of the winch in the front of your TITAN snowmobile

2883850
ALL TITAN



ICE AUGER RACK

- Premium steel rack securely holds your ice auger for easy transport

2882799
ALL TITAN



A LOCK & RIDE
VERSA REAR CARGO RACK

- Rugged aluminum powder-coated rear rack delivers versatile storage solutions
- Bolts securely to tunnel and features multiple cargo tie-down points

2882792
ALL TITAN

B LOCK & RIDE
VERSA REAR CARGO BOX

- Heavy-duty roto-molded box mounts to rear luggage rack with Lock & Ride technology
- Easy-open hinge lid can accommodate an optional padlock for security
- A total of 60 liters of storage space

2882793
ALL TITAN



CARGO BOX BUNGEE NET (EXTERIOR)

- Expands storage of the Lock & Ride Versa Rear Cargo Box
- Secure extra cargo to the exterior of the cargo box for easy access and increased capacity

2884300
ALL TITAN



SCANDI BOX

- Cargo box with backrest, 100 liter with straps.
- Cargo can also be stored on the lid with straps.
- Molded to fit seamlessly with the TITAN Versa rack

P283
ALL TITAN

NOTE: (CARGO BOXES CAN ONLY BE USED WITH 1-UP SEAT , L&R SOLD SEPARATELY.)



- Cargo box 110 liter with straps. Titan Adventure
- Cargo can also be stored on the lid with straps.
- Molded to fit seamlessly with the TITAN Versa rack

P284
ALL TITAN



AXYS - TITAN



LOCK & RIDE

VERSA TOURING PASSENGER SEAT

- Attaches/removes in seconds with Lock & Ride technology
- Heated version available
- Includes heated grips and plug-in for passenger's heated helmet visor
- Requires Versa Rear Cargo Rack (2882792), sold separately

Standard | 2882791

Heated  | 2882801

ALL TITAN

STANDARD ON TITAN ADVENTURE



PASSENGER FOOTRESTS

- Add passenger comfort and security with passenger footrests
- Extruded aluminum design attaches directly to running board

2882797

ALL TITAN



UNDER-PASSENGER SEAT BAG

- Take advantage of underseat space with this easy-access storage bag
- Semi-rigid design retains its shape even when empty
- Attaches easily with Velcro® strips

2882807

ALL TITAN

POLARIS TITAN HEATED SEAT 

- Keep warm during the most demanding winter rides
- Features easy-to-use high/low/off switch for complete control
- Complete seat assembly with all mounting hardware and harness included

2882747
ALL TITAN



LOCK & RIDE FLEX

CONNECTED TECHNOLOGY

MATRIX

AXYS

PRO-RIDE

RIDE READINESS

CUSTOMIZATION

COVERS

TRANSPORT

TRACTION & CONTROL

TRACKS

RUNNING BOARD CLOSE-OUT PLATES

- Aids in water and slush protection when riding in wet conditions
- Premium polyethylene design delivers light weight protection

2882810
ALL TITAN



TITAN REAR BUMPER HANDLES

- Convenient rear grab points for your TITAN

2882803
ALL TITAN



TAILLIGHT GUARD

- Protect the top housing of your taillight from stowed gear or accessories
- Rugged aluminum construction secures directly to the rear cargo platform

2882809
ALL TITAN

AXYS - HITCHES



1.25" RECEIVER

2882795
ALL TITAN



J-HITCH TITAN SCANDI

- 4-Bolts safety hitch.

B0131
ALL TITAN



BALL HITCH

- Allows customer to use any size ball with 3/4" shank
- Requires 1.25" receiver (2882795), sold separately
- Ball not included

2882813
ALL TITAN



HITCH ADAPTER

- Bolts onto either the J-hook or Standard hitch to allow them to be used with 1.25" receiver installed
- Allows user to change between J-hook, Standard and Ball Hitch without the use of tools

2882814
ALL TITAN



PRO-RIDE

The Pro-Ride platform delivers consistent performance at an unbeatable value. Enhance your ride with our collection of accessories developed for the Pro-Ride platform, including everything you need for optimized storage, comfort and protection.

RUSH®

MY11-MY14 RUSH

RMK

MY11-15 PRO RMK
MY11-15 RMK
MY11-15 ASSAULT
MY20-23 RMK EVO

SWITCHBACK

MY10-14 PRO-R
MY11-MY16 ASSAULT
MY12-14 ADVENTURE
MY23 550 SPORT

VOYAGEUR

MY14-16 600
MY13-23 550 144/155

INDY

MY13-21 600
MY13-22 550 121/144
MY13-23 550 LXT/ADVENTURE
MY19-23 EVO
MY23 550 SPORT



PRO-RIDE - STORAGE

RETROFIT YOUR SLED WITH LOCK & RIDE FLEX

LOCK & RIDE FLEX ADAPTER KIT

AXYS PRO-RIDE

• Add Lock & Ride Flex storage to AXYS and Pro-Ride full tunnel sleds

2884939 **TOP SELLER**

ALL PRO-RIDE & AXYS SLEDS WITH TUNNEL T-SLOTS. NOT COMPATIBLE WITH LOCK & RIDE FLEX M2 SEAT



LOCK & RIDE FLEX SPORT TUNNEL BAG

MATRYX AXYS PRO-RIDE

Low | 2884453

ALL MATRYX, ALL SNOWMOBILES EQUIPPED WITH LOCK & RIDE FLEX ADAPTER KIT



Liner Bag - Small
2889260

Tall | 2884454

ALL MATRYX, ALL SNOWMOBILES EQUIPPED WITH LOCK & RIDE FLEX ADAPTER KIT



Liner Bag - Large
2889261



LOCK & RIDE FLEX ADVENTURE TUNNEL BAG

MATRYX AXYS PRO-RIDE

Low | 2884455

ALL MATRYX, ALL SNOWMOBILES EQUIPPED WITH LOCK & RIDE FLEX ADAPTER KIT



Liner Bag - Small
2889262

Tall | 2884456 **TOP SELLER**

ALL MATRYX, ALL SNOWMOBILES EQUIPPED WITH LOCK & RIDE FLEX ADAPTER KIT



Liner Bag - Large
2889263



LOCK & RIDE FLEX BURANDT BAG - MEDIUM

MATRYX AXYS PRO-RIDE

- Compression molded, turtle shell design for enhanced weather resistance
- Oversized buckles provide easy access to gear with your gloves on

- Integrated mounts for shovel jacket enabling riders to carry a secondary shovel
- Installation on AXYS and Pro-Ride sleds requires the Lock & Ride Flex Adapter Kit (2884939), sold separately

NEW Carbon Print with Red Accents | 2889897

NEW Carbon Print with Blue Accents | 2890009

Black | 2889258 **TOP SELLER**

Liner Bag - Medium | 2889349

ALL MATRYX 129 AND LONGER, ALL SNOWMOBILES 129 AND LONGER WITH FULL TUNNEL AND LOCK & RIDE FLEX ADAPTER KIT



LOCK & RIDE FLEX BURANDT BAG - LARGE

MATRYX AXYS PRO-RIDE

- Compression molded, turtle shell design for enhanced weather resistance
- Oversized buckles provide easy access to gear with your gloves on

- Integrated mounts for shovel jacket enabling riders to carry a secondary shovel
- Installation on AXYS and Pro-Ride sleds requires the Lock & Ride Flex Adapter Kit (2884939), sold separately

NEW Carbon Print with Red Accents | 2889900

NEW Carbon Print with Blue Accents | 2890010

Black | 2889259 **TOP SELLER**

Liner Bag - Large | 2889350

ALL MATRYX 165 AND LONGER, ALL SNOWMOBILES 165 AND LONGER WITH FULL TUNNEL AND LOCK & RIDE FLEX ADAPTER KIT



SHOVEL JACKET

MATRYX AXYS PRO-RIDE

Jacket | 2889322 **TOP SELLER**

ALL SNOWMOBILES EQUIPPED WITH A LOCK & RIDE FLEX BURANDT BAG

PIEPS® Shovel T 825 Pro + With Saw Blade | 2883680

ALL SNOWMOBILES



PRO-RIDE - STORAGE



ULTIMATE DEFROST BAG

PRO-RIDE

- Provides warm, dry place for goggles, gloves and more
- Rigid construction holds its shape
- Durable 1,680 denier black ballistic nylon with water-resistant coating

2879090
MY10-20 PRO-RIDE, INCLUDES INDY AND VOYAGEUR, PIDD NOT INCLUDED



3.9 LITERS

HANDLEBAR BAG

PRO-RIDE

- Provides quick, convenient access to essential items
- Semi-rigid design retains its shape even when empty
- Attaches easily with all-weather Velcro® strips

2882829
PRO-RIDE INDY



NEW
LOCK & RIDE FLEX
ADVENTURE RACK WITH SKI/
SNOWBOARD ATTACHMENT

MATRYX AXYS PRO-RIDE

- Get more out of your ride with the versatility of the Adventure Rack
- Add the Ski and Snowboard Attachment to the Adventure Rack for a fully integrated solution. Skiing and snowboarding has never been easier. Catch a ride to the top on your sled and bring all your gear to coast down
- Size medium - fits on tunnel lengths 136" and longer-use with size Small Lock & Ride Flex storage bags on 155" tunnels and longer

A Adventure Rack | 2890018
B Ski/Snowboard Attachment | 2890017

ALL MATRYX 136 AND LONGER,
ALL SNOWMOBILES 136 AND LONGER WITH FULL TUNNEL
AND LOCK AND RIDE FLEX ADAPTER KIT



UNDERHOOD GOGGLE BAG

PRO-RIDE

- Heavy-duty nylon bag mounts under hood, above exhaust

2878735
ALL PRO-RIDE



8.2 LITERS

UNDERSEAT BAG

PRO-RIDE

- Take advantage of underseat space with this easy-access storage bag
- Semi-rigid design retains its shape even when empty
- Attaches easily with all-weather Velcro® strips

2882786
MY13-20 INDY, MY13-20 INDY SP, MY14-20 INDY ES



NEW
LOCK & RIDE FLEX
WATERPROOF ROLL TOP BAG

MATRYX AXYS PRO-RIDE

- Completely waterproof to protect valuables
- Roll top design allows for quick and easy access

2890008
ALL MATRYX,
ALL SNOWMOBILES 121 AND LONGER WITH FULL TUNNEL
AND LOCK AND RIDE FLEX ADAPTER KIT



TUNNEL BAG

PRO-RIDE

- Tunnel-top storage provides storage for larger items including clothing and gloves
- Semi-rigid design retains its shape even when empty
- Large zippered opening delivers easy storage access

2882788
MY13-20 INDY, MY13-20 INDY SP,
MY14-20 INDY ES

15.2 LITERS



HANDLEBAR MAP BAG

MATRYX AXYS PRO-RIDE

- Clear poly window displays trail map for easier navigation
- Attaches easily with all-weather Velcro® strips

2882824
ALL SNOWMOBILES



46.4 LITERS

ADVENTURE TUNNEL BAG

AXYS PRO-RIDE

- 2" buckles make it easy to access your gear with gloves on
- Includes two waterproof duffels to easily bring gear inside after the ride
- Ample storage space to carry everything you need

2882816
Bag Liner | 2889114
ALL INDY 129, INDY 137, SBA 144, PRO-RMK



9.5 LITERS

EVO TUNNEL STORAGE BAG

PRO-RIDE

- Provides underseat storage for quick access
- Compression-molded design provides rigidity
- Attaches easily with all-weather Velcro® strips

2883671
INDY & RMK EVO '19-23

2884939 Lock N Ride Flex adapter kit
ALL PRO-RIDE & AXYS SLEDS W/ TUNNEL T-SLOTS,
NOT COMPATIBLE WITH LOCK & RIDE FLEX M2 SEAT

PRO-RIDE - RACKS



ACCESSORIES

LOCK & RIDE
FLEX

CONNECTED
TECHNOLOGY

MATRIX

AXYS

PRO-RIDE

RIDE
READINESS

CUSTOMIZATION

COVERS

TRANSPORT

TRACTION
& CONTROL

TRACKS

VOYAGEUR 155" EXTREME REAR RACK PRO-RIDE

- Strong, durable tubular construction
- Easy bolt-on installation
- Fits P261 Cargo box

2880275

MY18-MY23 550 VOYAGEUR AND
INDY ADVENTURE 155

P261 Cargo box



CARGO RACK 144"

AXYS PRO-RIDE

- Design offers three-level storage with low, medium and high cross bars
- Angled design accommodates tie-down straps to secure cargo
- Fits 2881968 Cargo rack bag and P294 Cargo box

Matte Black | 2881940-458

ALL AXYS, PRO-RIDE 144

P294 Cargo box

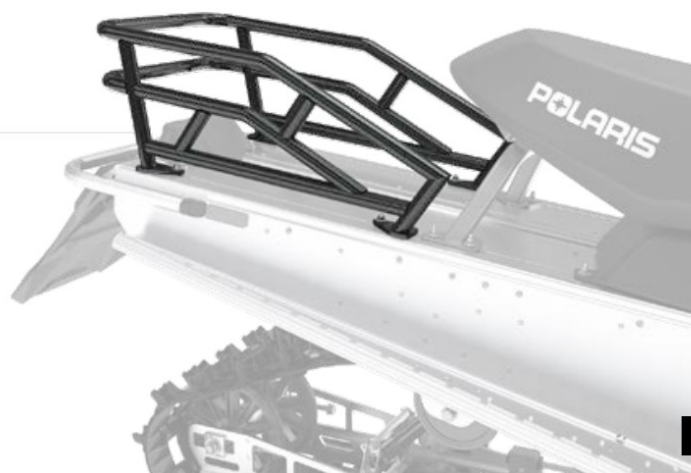

PRO-RIDE - WINDSHIELDS

20"
TALL

WIDE WINDSHIELD PRO-RIDE

Clear 2878512

ALL PRO-RIDE



7"
TALL



LOW WINDSHIELD PRO-RIDE

Black 2878779

White 2879097

ALL PRO-RIDE

14"
TALL



MID WINDSHIELD PRO-RIDE

Smoke 2877841

Matte Black 2879828

White Gloss 2879829

ALL PRO-RIDE

24"
TALL

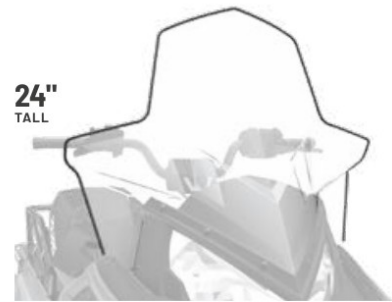

EXTRA-WIDE TALL WINDSHIELD PRO-RIDE

Clear 2879156

ALL PRO-RIDE

PRO-RIDE - PROTECTION



ULTIMATE FRONT BUMPER

PRO-RIDE

Raw 2879727

Bright White 2879727-133

Indy Red 2879727-293

Matte Black 2879727-458

ALL PRO-RIDE

PRO-RIDE - EVO UPGRADE KITS



ACCESSORIES

LOCK & RIDE
FLEX

CONNECTED
TECHNOLOGY

MATRIX

AXIS

PRO-RIDE

RIDE
READINESS

CUSTOMIZATION

COVERS

TRANSPORT

TRACTION
& CONTROL

TRACKS

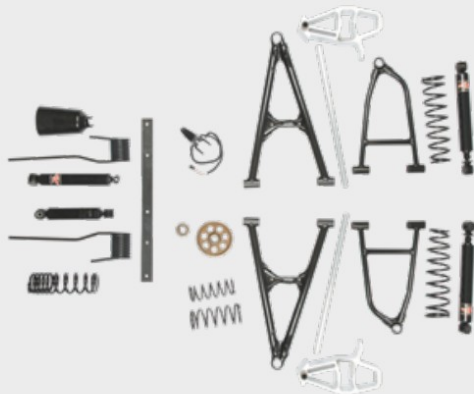

INDY EVO UPGRADE KIT PRO-RIDE

- Comes with everything you need to evolve your INDY EVO as the rider's skill increases
- Includes tie rods, control arms, spindles, shocks and more
- Convert into a full-speed sled

2883939
INDY EVO MY19-21



RMK EVO UPGRADE KIT PRO-RIDE

- Comes with everything you need to evolve your RMK EVO as the rider's skill increases
- Includes IFS shocks, springs and all the parts needed for full power conversion
- Convert into a full-speed sled

2884251
RMK EVO MY20-21

PRO-RIDE - RIDER COMFORT



HANDLEBAR MIRRORS PRO-RIDE

- Can be used with stock handlebar pad
- Sold as a pair

2876297
ALL PRO-RIDE



HOOD MOUNT MIRRORS PRO-RIDE

- Wide-angle view
- Non-fogging glass
- Folding design for use with cover
- Includes mounting hardware
- Sold as a pair

2877803
ALL PRO-RIDE



KNEE PADS PRO-RIDE

- Set of two

2878195
ALL PRO-RIDE

RIDE READINESS



ÖHLINS® HIGH PERFORMANCE SHOCKS

- P-Type Shocks with springs included. Fully re-buildable.
- Adjustable compression and rebound adjuster.
- SWB shocks are updated for 2019 models.
- High performance
- Öhlins shocks are always updated for the newest model years.

*ÖHLINS SHOCKS FOR TITAN IS AVAILABLE. CONTACT YOUR NEAREST DEALER (SWB ASSAULT, NO SPRING INCLUDED)

PB610 | FRONT PRO RMK 36" KHAOS (PAIR), 0-ADJUST 19-
PB607 | FRONT RMK/SKS 17-19 (PAIR), 800 SKS 146" 19, 850 SKS-21
PB608 | CENTER RMK/ SKS 17-21, PRO RMK-21
MNO II | CENTER 36PC, RMK KHAOS 20-
PB609 | REAR RMK/SKS 17-21, KHAOS 20-
PB614 | FRONT SWB ASSAULT (PAIR) 17-
PB615 | CENTER SWB ASSAULT 17-20 | SKS 146" 19-
PB616 | REAR SWB ASSAULT 17-20, SKS 146" (36) 19-



KEY-OPERATED ELECTRIC START KIT

- Easier to use and more convenient than pull starts
- Ideal for extreme cold conditions
- Battery required and not included

2881243

ALL AXYS PRO-RMK, SKS,
AXYS RMK ASSAULT

2880396

ALL AXYS RUSH, SWITCHBACK

2883931

ALL AXYS 850 PRO-RMK

2883849

ALL AXYS 850 RUSH, INDY XC, SBA

2879330

ALL PRO-RIDE

2879833

VOYAGEUR 550, INDY 550

2884955

ALL MATRYX 129, 137, AND SBA 146

2889361

ALL MATRYX RMK (NON-BOOST)

2889362

MATRYX RMK BOOST

2884776

ALL 800 MY20-21 AXYS
SWITCHBACK, MY 20 RUSH

2884777

ALL 800 MY20 AXYS RMK



BATTERY (REQUIRED FOR ELECTRIC START KITS)

- Sealed, Non-Spill
- 4013045: YTX20
- E04999: ETX20
- ALL MATRYX, AXYS, PRO-RIDE



TETHER SWITCH

- Shuts off vehicle if you're separated from it
- Easy to install, mounts directly on pod, connects to prewired harness

2874379

ALL SNOWMOBILES

2883823

ALL 850 SNOWMOBILES



MAGNETIC TETHER

- Shuts off vehicle if you're separated from it
- Magnetic engagement enhances connection and retention
- Easy to install: mounts directly to console via a pre-wired harness

2889143

ALL 600/800 SNOWMOBILES

2889142

ALL 650/850 SNOWMOBILES

12 VOLT/RCA PLUGS

- 12v accessory plugs into 12v outlet, great for GPS or phone, dash mount
- RCA adapter allows you to plug in a heated face shield or vest
- RCA power plug includes all hardware required to add an RCA outlet

RCA Power Plug | 2883824

ALL 850 SNOWMOBILES

RCA Adapter | 2878227

ALL AXYS, ALL PRO-RIDE

RCA Power Plug | 2878780

ALL AXYS, PRO-RIDE, AND TITAN



RCA ADAPTER

12v | 2878475

ALL AXYS, ALL PRO-RIDE

12v | 2884938

ALL MATRYX



CRUZ TOOLS

- Tool kit consists of all the tools you'll need for most trailside repairs
- Multiple types of tools ranging from wrenches, ratchets, pliers, and zip ties

2889416
ALL SNOWMOBILES

TOOL ROLL

- Tool roll is designed to hold all the tools from the tool kit
- Easily put your tools in one place and make it easy to carry

2889417
ALL SNOWMOBILES



WALKER EVANS® VELOCITY SHOCK UPGRADE KIT **AXYS**

- Race-proven featuring position-sensitive reservoir for a wider range of performance
- Calibrated for ultimate control and comfort with advanced bottoming-resistance technology

2884597
ALL INDY AXYS 129/137
STANDARD ON AXYS INDY XCR



RMK REACT FRONT SUSPENSION KIT **AXYS**

- Comes with everything you need to convert your AXYS PRO-RMK to a 36" wide front end
- Includes shocks, upper and lower control arms, tie rods, sway bar and all hardware

2883686-309
ALL AXYS RMK
STANDARD ON MY19 & NEWER PRO RMK & RMK KHAOS MODELS

FOR ADDITIONAL SHOCKS VISIT
POLARIS.COM/SUSPENSION



ICE SCRATCHERS
AXYS **PRO-RIDE**

- Direct ice chips into skid to lube and cool hi-fax

2882028 **★ TOP SELLER**
AXYS PRO-RMK, ASSAULT RMK, SKS 155
2876256
ALL PRO-RIDE RMK



RMK BOGIE WHEEL KIT
AXYS **PRO-RIDE**

- Wheels install on stock skid
- Reduces hi-fax wear on hard-pack snow and ice
- A total of three pairs can be installed onto a stock skid

2882048
ALL AXYS RMK
2878251
ALL PRO-RIDE RMK



VESPEL® HYFAX
MATRIX **AXYS** **PRO-RIDE**

- Long lasting VespeL® Hyfax allows for more miles compared to standard extruded plastic option hyfax
- Made from stronger compound than the plastic option

2889115
ALL SNOWMOBILES 120 - 155



SNOBUNJE® RATTLER
MATRIX **AXYS** **PRO-RIDE**

- Deep snow extraction device
- Hook attaches to ski, use handle to pull

2874420
ALL SNOWMOBILES

BUILD YOUR DREAM MACHINE

Create your one of a kind sled that will turn heads. Polaris offers a full lineup of color matched accessories for ultimate style and personalization. Design your sled to match your unique personality. Why? Because you can.

HAND GUARDS

MATRYX P. 93
AXYS P. 104

WINDSHIELDS

MATRYX P. 95
AXYS P. 106
PRO-RIDE P. 116

REAR BUMPERS

MATRYX P. 95
AXYS P. 125

STORAGE

MATRYX P. 87
AXYS P. 97
PRO-RIDE P. 113

GRILL INSERTS

MATRYX P. 95

FRONT BUMPERS

MATRYX P. 95
AXYS P. 107
PRO-RIDE P. 116

SPINDLES

ALL MODELS P. 121

SKI TOES

ALL MODELS P. 121

SKIS

ALL MODELS P. 121

SKID PLATES

MATRYX P. 95
AXYS P. 107



POLARIS SLED WRAPS
by ARCTICFXGRAPHICS.COM



**MAKE IT YOURS WITH A
CUSTOM WRAP BY
ARCTICFX.**

**BUILD YOURS NOW:
POLARIS.COM/AFXWRAPS**



At Cobra Cords we are focused on creating high performance pull start cords. Our products utilize fiber, braiding and coating technologies to create a pull cord that is engineered to last. Cobra Cords are 100% lifetime guaranteed.

NEW
SNOWMOBILE COBRA® CORD

Black	2889918
Red	2889919
Blue	2889920
Purple	2889921
Pink	2889922

ALL SNOWMOBILES



ACCESSORIES

LOCK & RIDE FLEX

CONNECTED TECHNOLOGY

MATRIX

AXYS

PRO-RIDE

RIDE READINESS

CUSTOMIZATION

COVERS

TRANSPORT

TRACTION & CONTROL

TRACKS

Give your sled a custom-finished look with factory-color-matched skis, ski toes and spindles. The combinations are endless.



MOUNTAIN

★ TOP SELLER

GRIPPER SKI

MATRIXX AXYS PRO-RIDE

- Deep 1.5" keel provides positive steering in deep, loose mountain snow
- Wide 6.75" ski delivers increased flotation
- Top traction surface for boot stepping on ski
- Includes black ski toe and hardware
- Requires carbide skags, sold separately
- Sold individually

Black	2877679-070
Indy Red	2877679-293
White	2877679-570

ALL SNOWMOBILES



UTILITY

PRO-FLOAT SKI

MATRIXX AXYS PRO-RIDE

- Adapted, 9.5" wide Pro-Steer ski design provides 45% more flotation for off-trail deep-snow performance
- Includes black ski toe
- Sold individually

Black	2880482
-------	---------

ALL SNOWMOBILES



TRAIL

PRO-STEER SKI

MATRIXX AXYS PRO-RIDE

- Engineered keel design and shortened skag perfect for the trail
- Supportive ribs for torsional stiffness
- No-slip traction atop ski
- Alternate ski stop may be required
- Includes black ski toe and hardware
- Sold individually
- Carbide skags required, sold separately

Black	2885164-070
Bright White	2885164-133
Indy Red	2885164-293

ALL SNOWMOBILES

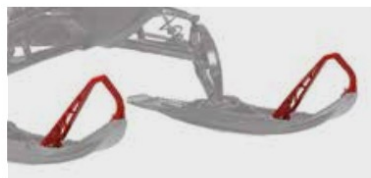

SKI TOE

Black	2889421-070
White	2889421-133
Indy Red	2889421-293
Orange Burst	2889421-647
Sky Blue	2889421-737
Plum Crazy	2889421-784
Polaris Blue (Non-Metallic)	2889421-795
Stealth Gray	2889421-804

ALL POLARIS SKIS



RUSH/SWITCHBACK

SPINDLES

- Strong, lightweight aluminum construction with same tolerances as stock spindles
- Exact replacement for stock spindles

RUSH/SWITCHBACK FITMENT: ALL AXYS 120 - 144 SNOWMOBILES
FORGED RMK FITMENT: ALL AXYS RMK



FORGED RMK

	RUSH/SWITCHBACK	FORGED RMK
Gloss Black	--	2884205-067
Indy Red	--	2884205-293
Matte Black	2881409-458	--
Lime Squeeze	2881409-630	--
Orange Burst	--	2884205-647



PROTECT YOUR SLED FROM THE ELEMENTS

KEEP YOUR SLED LOOKING NEW WITH A POLARIS COVER

- Keep snow and ice off of your sled in between days of riding
- Protect your sled from dirt and slush while trailering
- Protect from harmful UV rays that could fade your coloring over time
- Choose between premium polyester for maximum protection and trailering or the overnight cover for in between rides

THE POLARIS ADVANTAGE WHY SHOULD YOU CHOOSE A POLARIS COVER?

1. **INTENTIONALLY DESIGNED** for your sled and features easy to use cinch strap technology for a secure hold and perfect fit
2. **PREMIUM MATERIALS** provide advanced protection and lasting durability through the elements
3. **RIDER-CENTRIC FEATURES** such as integrated zippers and straps make Polaris covers easy to use with quick access



OVERNIGHT/DUST COVER

Lightweight and packable. Ideal for overnight multi-day drops or parking in a shop.



3/4 COVER

This cover is ideal for overnight protection, when the sled is stored between rides and during trailering. Designed to fit over all windshield styles and all accessories. Does not cover the tunnel so you still have access to storage & racks.



FULL COVER

Full sled protection perfect fitment for your model. Great for towing and off season storage. Zipper access to gas cap, quick adjust cinchable straps for tightening covers, convenient looped storage loop for cinchable hooks.



MATRYX COVERS



MATRYX RMK PREMIUM POLYESTER FULL COVER

MATRYX

- Reinforced material added in high impact areas
- New rear strapping system that is much easier to put on and reduces buffeting when trailering
- Improved windshield strap that results in a tighter fit

Full | **2889348** *TOP SELLER
ALL MATRYX RMK 146 - 165



RETRO

MATRYX PREMIUM POLYESTER FULL CONVERTIBLE COVER

MATRYX

- MATRYX redesigned cinch straps are easier to use and hold secure for a premium fit
- Advanced polyester blend for increased protection
- Convertible Cover: expands and adapts to fit various MATRYX accessory configurations
- Features an integrated rear zipper to accommodate for accessories including seats
- Works with 2-Up seat solutions.

NEW Black | **2890074** *TOP SELLER
Retro | **2889914**
ALL MATRYX 129, 137, AND SBA 146



MATRYX OVERNIGHT COVER

MATRYX

- Protects sled from the elements when stored outside overnight
- Made of light weight polyester that is easy to fold and store
- Ideal for overnight multi-day trips or parked in a shop

2884749
ALL MATRYX 129, 137, AND SBA 146

AXYS & PRO-RIDE COVERS

PREMIUM POLYESTER

PRO-RIDE
AXYS

- Light weight, custom fit and extreme protection for the ultimate trailering cover
- Premium UV-resistant and water-repellent capability, great for extended outdoor storage
- Adapts to a full range of windshield heights and secures with integrated straps
- Full Convertible Covers: Cover expands and adapts to fit various accessory configurations

All AXYS Full Tunnel 129, 137, 144 & 146	Full Convertible	2883568
All TITAN	Full Convertible	2882800
PRO-RMK/SKS	¾	2881042
RMK ASSAULT	¾	
RUSH	¾	
SWITCHBACK	¾	2880431
SWITCHBACK ADVENTURE	¾	
RUSH	Full	2882223
SWITCHBACK	Full	2882224
SWITCHBACK with Rack/ADVENTURE	Full	2882225
SWITCHBACK 144	Full	2882133
PRO-RMK 155 / SKS 146/155	Full	
RMK ASSAULT 163/174	Full	2882134

CANVAS

PRO-RIDE
AXYS

- Coated, heavy-gauge canvas remains flexible in extreme cold temperatures
- Adjusts to a full range of windshield heights and secures with integrated straps
- Water-repellent, UV-resistant and versatile for trailering or storage

RUSH/SWITCHBACK with Sport Rack	Full	2882136
RUSH	Full	2882135
SWITCHBACK 137	Full	2882137
SWITCHBACK ADVENTURE with Rack	Full	2882138
SWITCHBACK ASSAULT 144	Full	
PRO-RMK 155 / SKS 146/155	Full	2881969
RMK 163/174	Full	2881980
INDY 121/INDY EVO	Full	2878725
550 INDY 144	Full	2879845
INDY VOYAGEUR 144	Full	
INDY LXT	Full	2880515
INDY VOYAGEUR 144/155 with 2-Up Seat	Full	
INDY VOYAGEUR 155	Full	2880516

UNDERCOVER AXYS

- Made to go under Polaris snow covers to provide an additional level of protection
- Easy to install and remove

2881981
ALL AXYS



NEW INDY 120 COVER

- Cover option for youth sled
 - Perfect for overnight or trailering
- 2889890**
ALL 120 SNOWMOBILES



TRANSPORT

★ TOP SELLER

2882998	TraxGrabber
2882970	72" TraxMat
2882967	Grips (set of 6)
2882979	LowPro Glide - Standard 9" - Double Set - 16pc. (40' Kit)
2882983	LowPro GripGlide - Standard 9" - Double Set - 16pc. (40' Kit)
2882984	Flex Glides Low Profile (set of 8)
2882985	Flex Glides High Profile (set of 8)
2884383	EdgeGuard - 12pc. Kit
2884382	Edge Glide 2.0 - 4pc. Kit (96")
2882989	Poly Shield Series III
2882990	V-Front Ramp Shield
2883004	Retrax - Self-Retracting Strap Set

POLARIS PART NUMBERS UTILIZED IN CHART ABOVE. ONLY TOP SELLERS PROVIDED. FULL PRODUCT LINE DETAIL IS AVAILABLE IN THE CONFIGURATOR.



CUSTOMIZE YOUR TRAILER WITH THE POLARIS ONLINE CONFIGURATOR

Fully customize your trailer using the Polaris online configurator. Select from the full range of Caliber® trailer products and when finished print a detailed parts list based on your selections.

VISIT POLARIS.COM/TRAILERING





SLED WHEELS

- New improved polymer
- Provides amazing mobility for snowmobiles
- Universal modular design works with most snowmobile skis
- Innovative design provides fast engagement and disengagement

Carbon Black | 2883853



RAMP PRO 2.0

680 KG RATING

- Innovative ramp design for snowmobiles, ATVs, UTVs and golf carts
 - Improved 2.0 design features 12" wide glides accommodating narrow RMK ski stances
- 2884576 **★ IMPROVED DESIGN**
ALL SNOWMOBILES

TRACTION AND GLIDE



INTEGRATED FINGERS



INTEGRATED FEET



Integrated Self-Retracting Strap Included

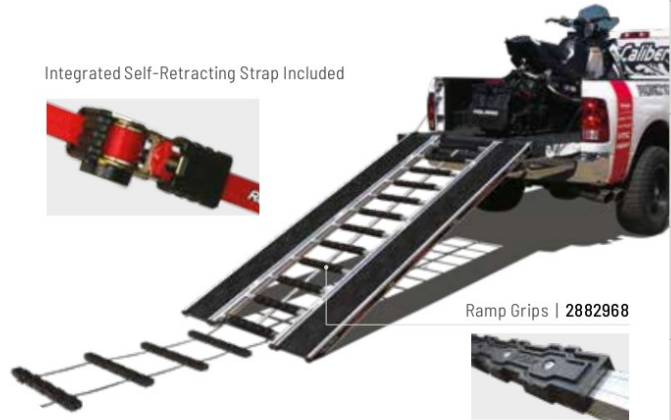

Ramp Grips | 2882968



TRAX WHEELS 2.0

500 POUND RATING

- Tapered sides allow track to easily drop in place
 - Specifically designed to accommodate all track pitches: 2.52", 2.86" and 3.0"
 - Over-sized 5" urethane casters make moving over rough surfaces a breeze
- 2884384



WWW.SUPERCLAMP.NET

THE #1 SNOWMOBILE & ATV TRAILER ACCESSORIES

FRONT CLAMP

- Adjustable to fit all snowmobiles
- Rubber silicone pads protect and secure skis
- Integrates to all trailers
- Includes deck hook

2882961

ALL SNOWMOBILES



REAR CLAMP

- Composite construction with silicone rubber padding
- Tension adjustment knob to fit all snowmobiles
- Secures via rear suspension skid
- 12" Supertac Kit included

2882962



SUPERCLAMP® DECK HOOK

2882963



SUPERCLAMP® TRAC HOOK

2882965



SUPERCLAMP® TRAC

2882964

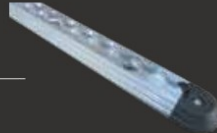

ACCESSORIES

LOCK & RIDE
FLEX

CONNECTED
TECHNOLOGY

MATRIX

AXIS

PRO-RIDE

RIDE
READINESS

CUSTOMIZATION

COVERS

TRANSPORT

TRACTION
& CONTROL

TRACKS

TRACTION & CONTROL

RIP WITH AN IRON GRIP

Whether you're replacing your carbides or looking to add more traction and control for enhanced safety and performance, premium Woody's® stud kits and carbide runners are exclusively engineered for your Polaris snowmobile.

CONTROL FOR HOW YOU RIDE

STUDS

Choose the right length stud for your track lug and then select a pattern to best suit your riding style for a touch of added control to monster holeshots.

TUNNEL PROTECTION

Required protection for when you stud, these "wear strips" protect your tunnel and vital cooling components from damage.

CARBIDES

Replacing or upgrading, add the right amount of ski control to match your track length, studding pattern and riding style.

STUD KITS



Includes everything to update your sled's traction—studs, nuts, backer plates, template and track drill bit.



FITMENT	SLED MODEL/TRACK	TRACK LENGTH	LUG HEIGHT	PITCH	STUD QUANTITY	STUD KIT	TUNNEL PROTECTOR
MY15-20	RUSH, COBRA, RIPS AW 2	120	1.352/1.25"	2.86	84	2884197	NOT REQUIRED
MY15-20	RUSH, STORM 150	120	1.5"	2.86	84	2883675	NOT REQUIRED
MY17-19	RUSH XCR, COBRA	121	1.352"	2.52	96	2884198	NOT REQUIRED
MY19-20	INDY 129, COBRA, RIPS AW 2	129	1.352/1.25"	2.86	90	2884199	2883572
MY19-20	INDY 129, STORM 150	129	1.5"	2.86	90	2883677	2883572
MY20	INDY XCR, COBRA	128	1.352"	2.52	102	2884302	2883572
MY15-20	SWITCHBACK 137, COBRA, RIPS AW 2	137	1.352/1.25"	2.86	96	2884200	NOT REQUIRED
MY15-20	SWITCHBACK 137, STORM 150	137	1.5"	2.86	96	2883679	NOT REQUIRED
MY18-20	SWITCHBACK XCR, COBRA	136	1.352"	2.52	108	2884201	NOT REQUIRED
MY20	INDY 137, COBRA, RIPS AW 2	137	1.352/1.25"	2.86	96	2884200	2884301
MY20	INDY 137, STORM 150	137	1.5"	2.86	96	2883679	2884301
MY17-20	SWITCHBACK ASSAULT, COBRA	144	1.352"	2.52	114	2884202	2884730
MY17-20	INDY 550 144, COBRA	144	1.352"	2.52	114	2884202	2879831
MY18-22	TITAN, RIPS AW	155	1.375"	2.86	108	2884203	2882880
MY18-22	TITAN, COBRA	155	1.5"	2.86	108	2884204	2882880
MY21-22	MATRYX 129, COBRA, ICE RIPPER	129	1.352/1.25"	2.86	90	2884199	2884961
MY21-22	MATRYX 129, STORM 150	129	1.5"	2.86	90	2883677	2884961
MY21-22	MATRYX 137, COBRA, ICE RIPPER	137	1.352/1.25"	2.86	96	2884200	2884962
MY21-22	MATRYX 137, STORM 150	137	1.5"	2.86	96	2883679	2884962
MY21-22	MATRYX 146, COBRA 1.3	146	1.352/1.25"	2.86	102	2884985	2884963
MY21-22	MATRYX 146, STORM 150, COBRA 1.6	146	1.5/1.6"	2.86	102	2884986	2884963

TUNNEL PROTECTION SOLD SEPARATELY

TUNNEL PROTECTION

SLED MODEL	FITMENT	PART NUMBER
AXYS INDY 129 SP, 129 XC, INDY XCR	MY19-22	2883572
TITAN	MY18-23	2882880
SWITCHBACK ASSAULT	MY17-21	2884730
SWITCHBACK ASSAULT	MY11-16	2878161
550 INDY 144, VOYAGEUR	MY11-23	2879831
550 INDY 121	MY11-23	2879830
600/800 INDY 121	MY13-15	2879212
AXYS INDY 137 SP, INDY 137 XC, INDY 137 ADVENTURE	MY20-22	2884301
INDY EVO	MY19-23	2879830
MATRYX 129 ★ TOP SELLER	MY21-23	2884961
MATRYX 137 ★ TOP SELLER	MY21-23	2884962
MATRYX 146 ★ TOP SELLER	MY21-23	2884963

CARBIDE WEAR STRIPS

Carbides need to be sharpened or replaced periodically due to normal wear and use. Rocks, cement, pavement and road crossings all contribute to carbide wear.

3"-4" CARBIDE



Perfect for sleds with a 121" track with 96 studs or less or sleds with 1" lugs taking corners at moderate speeds

CHOOSE YOUR LENGTH

6" CARBIDE



Ideal for sleds in the 136" track range with up to 1 1/4" lugs or shorter track sleds with more than 96 studs

8" CARBIDE



Best for ultimate-performance sleds with a 144" track or longer with paddles and/or the maximum amount of studs

SINGLE RUNNER

Provides known reliability, handling and control.

SKI	NOTE	3"	4"	6"	6"	8"	8"
Pro-Steer/Pro-Float	Sold in Pack of 2	--	2879025 ★ TOP SELLER	--	2879026 ★ TOP SELLER	--	2879027
Gripper	Sold in Pack of 2	2875723 ★ TOP SELLER	--	2877880	--	2877881	--

DOUBLE RUNNER

Provides an increase in steering control in icy conditions and minimizes darting when riding on packed trails. Perfect to pair with a studded track.

SKI	NOTE	SLIM JIM		DOOLY	
		4"	6"	4"	6"
Pro-Steer/Pro-Float/Gripper	Sold Individually	2882956	2882957	2882953	2882954



BITEHARDER® CARBIDE SHARPENER

- Designed to be used with portable drill for sharpening anywhere
- Quickly and easily puts a fresh edge on wear bars for improved handling
- Long-lasting diamond media can sharpen up to 40 wear bars

2882952

ALL SNOWMOBILES

FOUR KEYS TO TRACK SELECTION



LENGTH

The inside circumference of the track is calculated as the drive pitch multiplied by the number of track segments. It must be correct to the nearest inch for proper fit without additional modifications to the skid frame.

DRIVE PITCH

The drive cog center distance around the circumference of the cogs on the drive axle. It must match the existing track or the drive cogs must be changed.

WIDTH

The measurement across the track governed by the width of the tunnel.

LUG HEIGHT

The distance lugs extend above the track surface.

- Trail: 1" - <1.5"
- On/Off Trail: 1.5" - <2"
- Deep Snow: 2" and greater

LUG HEIGHT

DRIVE PITCH



SEE ALL TRACKS OPTIONS AT POLARIS.COM/TRACKS

TRAIL



ICE STORM 150

ON TRAIL OFF TRAIL

- Two-height lug design offers deep-snow flotation with handlebar-gripping acceleration
- Factory-pre-studded for improved traction and control on icy conditions
- 1.25" outer lugs and 1.5" cup-shaped center lugs provide power and traction on packed trails and turns

LENGTH	PITCH	LUG HEIGHT	
120"	2.86"	1.25"	2839388
129"	2.86"	1.25"	2839389
137"	2.86"	1.25"	2839390
146"	2.86"	1.25"	2839391

HURRICANE

ON TRAIL OFF TRAIL

- Designed based on mountain tracks, it provides off-trail performance in deep snow while maintaining on-trail agility
- 1.75" cupped profile design provides unparalleled grip in the backcountry
- 1.75" tall lug profile design reduces vibration, applying more power to the ground

LENGTH	PITCH	LUG HEIGHT	
120"	2.86"	1.75"	2839400
129"	2.86"	1.75"	2839401
137"	2.86"	1.75"	2839402
146"	2.86"	1.75"	2839403

COBRA

ON TRAIL OFF TRAIL

- Cupped lugs for superior acceleration and braking in loose, soft-snow conditions
- Flexible lug design for superior off-trail performance

LENGTH	PITCH	LUG HEIGHT	
120"	2.86"	1.352"	2839284
121"	2.52"	1.352"	2839052
129"	2.86"	1.352"	2839235
136"	2.52"	1.352"	2839061
137"	2.86"	1.352"	2839307
137"	2.86"	1.352"	5413661
144"	2.52"	1.352"	2839107
144"	2.86"	2.52"	5414013
144"	2.86"	1.6"	5416162
155"	2.86"	1.5"	5415826
155"	2.86"	1.8"	5416020
136"	2.52"	1.352"	5413655
128"	2.52"	1.352"	5416296
129"	2.86"	1.352"	5416604



ICE RIPPER

ON TRAIL OFF TRAIL

- Factory pre-studded for improved traction and control
- 1.25" lug height for improved traction and stability
- RipSaw-based attack angled lugs for excellent forward and lateral bite

LENGTH	PITCH	LUG HEIGHT	
137"	2.86"	1.25"	5416995



HACKSAW

ON TRAIL OFF TRAIL

- 1" lug height for low rolling resistance that improves fuel economy
- Crescent lug features recessed tips and cutting edges for forward and lateral bite on hard-pack
- Hard-wearing rigid lugs for mile after mile of dependable use
- Narrow lug base to reduce rolling resistance and maximize top speed

LENGTH	PITCH	LUG HEIGHT	
121"	2.52"	1"	5413198
136"	2.52"	1"	5413318



ICE ATTAk XT

ON TRAIL OFF TRAIL

- Factory-pre-studded for improved traction and control
- Designed to provide even better ice performance than the ICE Ripper XT
- 1.22" lug height provides better handling and stability
- Optimized rubber compound for superior traction on groomed trail

LENGTH	PITCH	LUG HEIGHT	
120"	2.86"	1.22"	2839190
121"	2.52"	1.22"	2839200
128"	2.52"	1.22"	2839201
129"	2.86"	1.22"	2839236
136"	2.86"	1.22"	2839202
137"	2.86"	1.22"	2839191
144"	2.52"	1.22"	2839203



STORM 150

ON TRAIL OFF TRAIL

- 1.25" outer lugs provide power through the tightest turns with ease, maintaining momentum and rider control
- 1.5" cup-shaped center lugs provide deep snow flotation and gut-wrenching acceleration on packed trails
- Optimized support columns provide the right balance of lug rigidity and flex for performance across the entire power band

LENGTH	PITCH	LUG HEIGHT	
120"	2.86"	1.25/1.5"	2839368
129"	2.86"	1.25/1.5"	2839369
137"	2.86"	1.25/1.5"	2839370
146"	2.86"	1.25/1.5"	2839371
137"	2.86"	1.25/1.5"	5416618
129"	2.86"	1.25/1.5"	5416605



RIPSAW

ON TRAIL OFF TRAIL

- Rigid lugs provide superior handling, acceleration and braking on groomed trails
- Narrow lug base for reduced rolling resistance and maximum top speed
- Angled profiles for aggressive forward and lateral bite

LENGTH	PITCH	LUG HEIGHT	
136"	2.52"	1.5"	2877648
120"	2.86"	1.25"	2839149
121"	2.52"	1.25"	2839968
128"	2.52"	1.25"	2839215
136"	2.52"	1.25"	2839969
155"	2.86"	1.375"	5416227



RIPSAW 2

ON TRAIL OFF TRAIL

- Tapered outside lug edges for less side bite when cornering
- Sharp angled lugs for excellent bite on hard-pack snow
- Cupped center and full outer lugs for traction on loose, less-compacted snow

LENGTH	PITCH	LUG HEIGHT	
120"	2.86"	1.25"	2839209
120"	2.86"	1.25"	5414653
121"	2.52"	1.25"	2839214
129"	2.86"	1.5"	2839305
136"	2.52"	1.25"	2839216
137"	2.86"	1.5"	2839306
137"	2.86"	1.25"	5414654
129"	2.86"	1.25"	5416585

TRACKS

MOUNTAIN



SERIES 8

ON TRAIL OFF TRAIL

- Lightweight 3.5" pitch track with 2.75" lugs optimized flex and improved stiffness
- Reduces mass and lowers inertia resulting in instantaneous lift, superior traction and optimum flotation for all types of mountain riding
- Fits the New Dual Extrovert Driveshaft*

LENGTH	PITCH	LUG HEIGHT	
155"	3.5"	2.75"	5415140
155"	3.5"	2.75"	5418047*
165"	3.5"	2.75"	5416367*
165"	3.5"	2.75"	5418048



SERIES 7

ON TRAIL OFF TRAIL

- Polaris exclusive
- Ideal track to provide lift in the deepest, softest snow conditions
- Features a new light weight single-ply design optimized for weight and powder snow performance

LENGTH	PITCH	LUG HEIGHT	
155"	3"	3"	5415393
163"	3"	3"	5415394
174"	3"	3"	5415786



SERIES 6

ON TRAIL OFF TRAIL

- Outstanding traction and control in deep snow
- Lugs provide tremendous flotation and great performance
- 2.6" lugs provide outstanding traction in all deep-snow conditions
- Design provides outstanding flotation and control

LENGTH	PITCH	LUG HEIGHT	
155"	2.86"	2.6"	5415391
163"	2.86"	2.6"	5415392
155"	2.86"	2.6"	5416838



SERIES 5.2

ON TRAIL OFF TRAIL

- Modeled after the modified Series 5.1 track used by Polaris hill climb racers
- Provides great traction both on- and off-trail
- Maintains excellent durability
- Optimized lug pattern for more forward lug contact

LENGTH	PITCH	LUG HEIGHT	
146"	2.86"	2.25"	5416498

MOUNTAIN



EPIC

ON TRAIL OFF TRAIL

- Reduced vibration and improved handling in deep snow
- Unique deep cup shaped lug design
- Stiffer columns design improves packed snow grip, riding agility and braking

LENGTH	PITCH	LUG HEIGHT	
162"	3"	2.8"	2839407
156"	3"	2.8"	2839408

CROSSOVER



BACKCOUNTRY

ON TRAIL OFF TRAIL

- Arched lug design with staggered, snocross-inspired pattern for excellent soft-snow traction

LENGTH	PITCH	LUG HEIGHT	
120"	2.86"	1.75"	5414894
121"	2.52"	1.75"	2839140
121"	2.52"	1.75"	5415097
136"	2.52"	1.75"	2839142
136"	2.52"	1.75"	5414378
137"	2.86"	1.75"	5414895
144"	2.52"	1.75"	5415096
144"	2.52"	1.75"	2839143
128"	2.52"	1.75"	5417031



COBRA 1.6

ON TRAIL OFF TRAIL

- Cupped lugs for superior acceleration and braking in loose, soft-snow conditions
- Flexible lug design for superior off-trail performance
- Select lugs are more rigid for traction on hard-packed snow

LENGTH	PITCH	LUG HEIGHT	
155"	2.86"	1.6"	5414902



ICE COBRA 1.6

ON TRAIL OFF TRAIL

- Cupped lugs for superior acceleration and braking in loose, soft-snow conditions
- Flexible lug design for superior off-trail performance
- Factory-pre-studded with 1.6" lugs for excellent all-round performance, especially on ungroomed trails

LENGTH	PITCH	LUG HEIGHT	
137"	2.86"	1.6"	2839246
155"	2.86"	1.6"	2839273

MISCELLANEOUS



COMPETITION TRACK

ON TRAIL OFF TRAIL

- Customized for competition
- Developed for and tested by top Polaris racers

LENGTH	PITCH	LUG HEIGHT	
155"	2.86"	2.1"	2877304



YOUTH 120

ON TRAIL OFF TRAIL

- Replacement track for the Polaris 120 INDY

LENGTH	PITCH	LUG HEIGHT	
68"	2.55"	.71"	5411751





SERIES 5.1

ON TRAIL OFF TRAIL

- Industry-leading deep-powder track; for 8T drive sprockets, 2.86" pitch
- Optimized lug pattern producing 19% more forward lug contact compared to our Series 5.0 track
- Soft and flexible tips for superior performance in deep snow

LENGTH	PITCH	LUG HEIGHT	
155"	2.86"	2.4"	5413622
163"	2.86"	2.4"	5413621

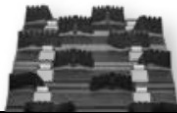

SERIES 4

ON TRAIL OFF TRAIL

- The standard in 2" deep-snow tracks; for 9T drive sprockets, 2.52" pitch
- Equal parts versatility and durability
- Stiff lug base for long wear and hard-pack performance
- Soft and flexible tips for superior performance in deep snow

LENGTH	PITCH	LUG HEIGHT	
144"	2.52"	2"	5413073
144"	2.52"	2"	5415692



PEAK 2.25

ON TRAIL OFF TRAIL

- Angular lugs bite and funnel snow under the snowmobile for outstanding flotation
- Features soft lugs for powder snow and hard lugs for heavy/wet snow
- Outer lug bars deliver better lateral control for improved handling

LENGTH	PITCH	LUG HEIGHT	
155"	2.86"	2.25"	5415002



SHOCKWAVE

ON TRAIL OFF TRAIL

- Designed for hard-working, utility applications
- Able to handle heavy workloads in deep-snow, off-trail environments
- Tackles on-trail and hard-packed applications

LENGTH	PITCH	LUG HEIGHT	
156"	2.52"	1"	5414453
121"	2.52"	0.91"	5412281



CHALLENGER

ON TRAIL OFF TRAIL

LENGTH	PITCH	LUG HEIGHT	
144"	2.52"	2"	2839875
146"	2.86"	2.5"	2839145
151"	2.52"	2"	2839876
154"	2.86"	2.5"	2839104
162"	3"	2.5"	2839319
163"	2.86"	2.5"	2839105



SNOW CROSS

ON TRAIL OFF TRAIL

- Customized for snocross competition
- Developed for and tested by top Polaris racers

LENGTH	PITCH	LUG HEIGHT	
129"	2.52"	1.75"	5450277



BACKCOUNTRY X2

ON TRAIL OFF TRAIL

- Arched lug design with staggered snocross-inspired pattern for excellent soft snow traction
- Rigid lug support columns and optimized rubber compound to deliver great on/off-trail performance
- 2.86" drive pitch

LENGTH	PITCH	LUG HEIGHT	
146"	2.86"	2"	2839417



ICE COBRA WT

ON TRAIL OFF TRAIL

- Extra-high 1.5" lugs for the best possible traction
- Cupped lug design ideal in soft, loose snow and for off-trail backcountry exploration
- Lightweight for greater efficiency and improved fuel economy

LENGTH	PITCH	LUG HEIGHT	
155"	2.86"	1.5"	2839414

FITS TITAN MODELS



GARAGE

FACTORY APPROVED.

Every Polaris snowmobile has been engineered and manufactured to deliver performance. Keep it that way by using the same lubricants, cleaners and service parts our factory-trained technicians use.

GARAGE CONTENTS

- 132 Maintenance
- 136 Oil
- 140 Lubricants & Garage Accessories
- 142 Belts, HD Parts & Battery Chargers
- 144 Service Parts



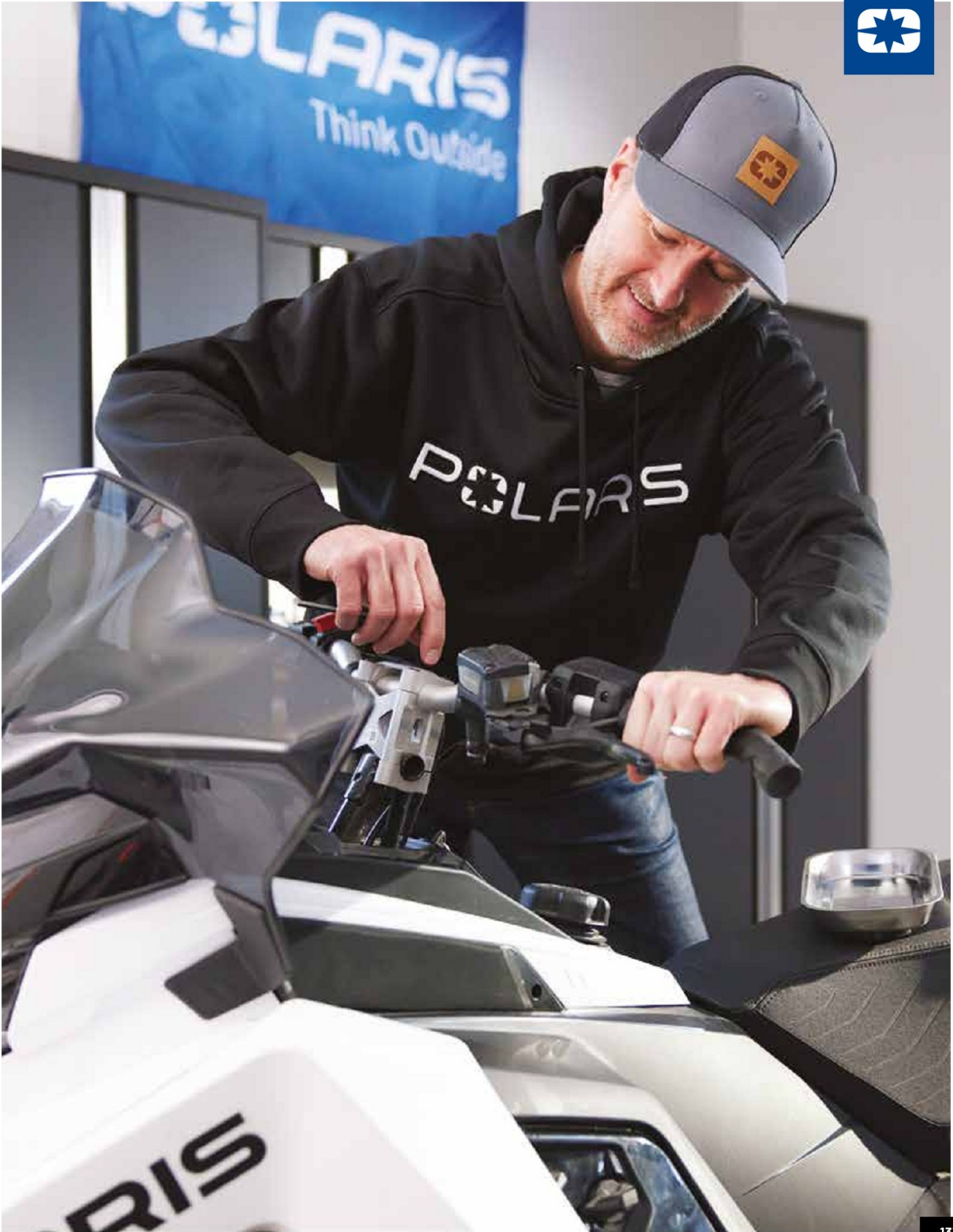

MAINTENANCE

SPARK PLUGS

New spark plugs, engineered specifically for your Polaris snowmobile, ensure quick starts, fuel efficiency and peak performance.

BATTERIES

Cold weather, harsh conditions and time can degrade a battery. A genuine Polaris replacement ensures an exacting fit and starting performance.

DRIVE BELTS

Only genuine Polaris Engineered Drive Belts provide a fit and optimum compound for maximum performance and reliability.

BREAK-IN PERIOD

The break-in period for a new belt is 50 miles. During this time, vary at moderate speeds while avoiding wide-open throttle.



FOR THE LIFE OF YOUR RIDE

We do more than build the world's greatest snowmobiles. We also work tirelessly to ensure the maintenance products you need are engineered to the same demanding standards. When it comes to drive belts, lubricants, batteries and more, we invest the time to make sure they're right, so you can spend more time riding.



SEE OUR LATEST MAINTENANCE TIPS AT
[POLARIS.COM/MAINTENANCE-VIDEOS](https://www.polaris.com/maintenance-videos)

MAINTENANCE SCHEDULE

PRE-SEASON

ENGINE OIL:

Fill to Recommended Level

GENERAL LUBRICATION:

All Fittings, Pivots, Cables, etc.

CHECK FOR WEAR:

Test, Clean & Check Fluid Levels

Spark Plugs, Track, Slider, Drive Belt & Carbides

2 - STROKE

ENGINE OIL:

Fill to Recommended Level

GENERAL LUBRICATION:

All Fittings, Pivots, Cables, etc.

CHECK FOR WEAR:

Test, Clean & Check Fluid Levels

Spark Plugs, Track, Slider, Drive Belt & Carbides

4 - STROKE

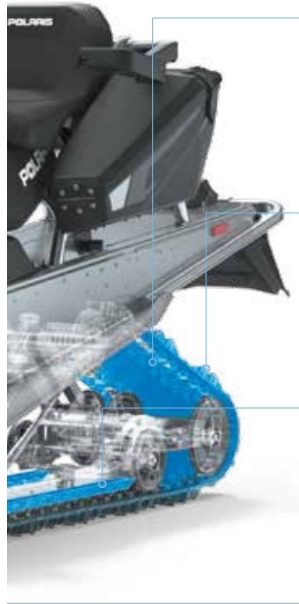

TRACKS

Enhance traction and control or replace a worn track with the latest trend in track pitch, length, lug height and patterns.

STUDS

Enhance your snowmobile's traction, control and performance with premium studs designed for your sled, track and riding style.

RAIL SLIDERS

Replace worn hyfax with genuine Polaris rail sliders for a perfect fit and engineered compound for optimum performance.

CARBIDES

Replace worn carbides or enhance your sled's handling with engineered exact fit wear bars with your choice of high-wear carbide length.

MAINTENANCE PARTS



BATTERIES

2-Stroke | 4013045: YTX20
E04999: ETX20
4-Stroke | 4018013



OIL FILTER

2522606



SPARK PLUGS

Engineered for your Polaris sled
2-Stroke | NGK® | 3022082
2-Stroke | Champion | 3070190
4-Stroke | NGK® | 3022662

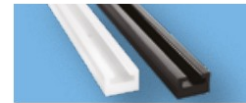

RAIL SLIDERS

5521632 5521633-309
5521633-070 5522144-070

Check your owner's manual for additional recommended service items and vehicle-specific timing.

**500mi (800km)
IN-SEASON**

- ENGINE OIL:**
Fill to Recommended Level
- DRIVE BELT:**
Inspect & Adjust
Follow Break-In Procedure After Installation
- TRANSMISSION FLUID:**
Change

**2,000mi (3,200km)
IN-SEASON**

- ENGINE OIL:**
Fill to Recommended Level
- CHECK FOR WEAR:**
Test, Clean & Check Fluid Levels
Spark Plugs, Track, Slider, Drive Belt & Carbides
- DRIVE BELT:**
Inspect & Adjust
Replace as Needed

END OF SEASON

- DRIVE BELT:**
Remove
Consult Owner's Manual
- FUEL:**
Add Fuel Stabilizer
- TRACK:**
Inspect
Reduce Tension During Storage
- BATTERY:**
Remove

- ENGINE OIL:**
Change Oil & Filter
Follow Break-In Procedure
- DRIVE BELT:**
Inspect & Adjust
Follow Break-In Procedure After Installation
- TRANSMISSION FLUID:**
Change
Follow Break-In Procedure

- ENGINE OIL:**
Fill to Recommended Level
- CHECK FOR WEAR:**
Test, Clean & Check Fluid Levels
Spark Plugs, Track, Slider, Drive Belt & Carbides
- DRIVE BELT:**
Inspect & Adjust
Replace as Needed

- ENGINE OIL:**
Change Oil & Filter (annually or every 4,000 miles)
- DRIVE BELT:**
Remove
Consult Owner's Manual
- FUEL:**
Add Fuel Stabilizer
- TRACK:**
Inspect
Reduce Tension During Storage
- BATTERY:**
Remove or Connect Trickle Charger

THE LIFE OF YOUR RIDE, ONLY THE BEST WILL DO

Top reliability and performance are the most important factors in Polaris Engineered Lubricants. Polaris Engineered Lubricants are engineered alongside the ever-evolving technology of Polaris high-performance engines to ensure you get an oil that is perfectly matched for your machine. Thousands of hours of testing every fluid in every engine design ensure you are getting the best product to keep you on the snow with your engine running strong.



LUBRICANTS DESIGNED FOR RELIABILITY AND PERFORMANCE

The latest engine technologies need to be matched with the latest lubricant technology. Only Polaris Engineered Lubricants are designed and tested along with new Polaris engine technologies including turbocharged 2-stroke snowmobile engines, and 4-stroke snowmobile engines.

OIL DEVELOPMENT

POLARIS INVESTS IN EACH OIL AT AND ABOVE THESE LEVELS.

12 DEDICATED
TEAM MEMBERS

FOCUSED ON
POLARIS OIL

1,000+
HOURS

DYNO TESTING

18+
MONTHS

DEVELOPMENT
& TESTING

40,000
MILES

FIELD TESTING



KEY POINTS OF PROTECTION

PISTON

Pistons play a critical role in engine operation and the wrong oil can lead to power loss, scuffing and poor performance.

- Maximizes power output while providing excellent film retention to prevent scuffing
- Superior stability in high temperatures, while minimizing carbon deposits and increasing long term reliability
- Oil flows at low temperatures to prevent hard starting



CRANKSHAFT BEARING

Provides hydrodynamic barrier on bearing interfaces to extend upper and lower rod bearing life.

- Provides accurate oiling under extreme cold conditions
- Excellent film retention and heat transfer properties
- Corrosion inhibitors protect during off-season storage



EXHAUST VALVE OPERATION

Exhaust valves control power output during on and off throttle use. Improper lubricants can cause carbon buildup and sticking of valves, reducing power.

- Provides detergency over the life of the exhaust valves
- Minimizes carbon buildup to ensure exhaust valves continue to move freely and keep the engine running at peak power
- Designed to provide smooth valve operation throughout the life of the engine





OIL FOR EVERY SLED, PROVEN IN THE TOUGHEST RACE.

When you're flying across 3,219 kilometers of Alaskan tundra, racing riders and the bitter winter wind to seize your immortal moment, you need equipment you can count on. Iron Dog® snowmobile riders count on Polaris Engineered Oils & Lubricants™ to withstand sub-zero temperatures, mountain ranges, and rock hard wind drifts at high speed over a grueling 35 hours.

They know Polaris® Engineers rigorously test every fluid before it earns the Polaris Engineered Lubricants™ badge and a spot on the shelf. So inside and out, their sled will be just as strong as their will to win. Whether you're racing across the Alaskan wilderness or just casually riding on a trail, you can be confident there's no better oil for your sled than Polaris Engineered Oils & Lubricants™.

VES

Low-odor, low-smoke oil formulation designed to improve exhaust valve performance. VES offers maximum engine protection.

OUR FORMULATION

- Synthetic Performance formula
- Proprietary anti-wear, corrosion and detergency additive package
- Retains film on critical engine parts after hot shutdown

YOUR ADVANTAGE

- Engineering approved for use across all snow engine platforms
- Cleaner burning resulting in extended life of cylinders, pistons, rings & bearings
- Protects engine during periods of non-use or storage
- Reduces pull effort by leaving components lubricated

VES EXTREME

Engineered, formulated and tested to easily handle the high demands of today's high-performance Polaris® snowmobile engines.

OUR FORMULATION

- Full synthetic, 100% PAO and Ester formula
- Highest engine film strength and lubricity protection
- Optimized mixture of heavy and light viscosity base oils and solvents
- Proprietary anti-wear, corrosion and detergency additive package

YOUR ADVANTAGE

- Best engine wear protection available for 2-cycle snowmobile engines on the market
- Maintains like-new HP performance throughout engine lifecycle
- Enhanced oil to ensure pins, bearings and all metal-on-metal components are protected
- Highest detergency available for ring lands, undercrown and exhaust valves

1L
502493
4L
502514

25L
502515
60L
502516

204L
502517

4L
502691
VES EXTREME, ONLY
AVAILABLE IN 4 LITERS

FOR OTHER SIZES 25L & 200L
CONTACT YOUR DEALER.

OIL DEVELOPMENT
POLARIS INVESTS IN EACH OIL
AT AND ABOVE THESE LEVELS.

12 DEDICATED
TEAM MEMBERS

FOCUSED ON
POLARIS OIL

18+
MONTHS

DEVELOPMENT &
TESTING

POLARIS®

ENGINEERED LUBRICANTS

FOR THE LIFE OF YOUR RIDE, ONLY THE BEST WILL DO.

In the continued pursuit of creating the best oil on snow, we invest in rigorous testing to ensure our oil delivers unrivaled consistency and performance. The result are Polaris Engineered Lubricants™ that are tested and perfected to deliver excellent total engine protection for the life of your ride.

Oil and cleaners featured are for EU distribution only. For other availability, contact your local dealer.



GARAGE

MAINTENANCE

OIL

LUBRICANTS & GARAGE ACCESSORIES

BELTS, HO PARTS & BATTERY CHARGERS

SERVICE PARTS

139

WE TRUST POLARIS VES OIL IN THE EXTREME 2,000 MILE (3,219 KM) IRON DOG EVENT BECAUSE AMONG ALL THE ISSUES WE FACE, IT'S ONE LESS THING WE HAVE TO WORRY ABOUT.

— MIKE MORGAN, IRON DOG RACER



POLARIS® BLUE

Synthetic Blend engine oil specially formulated for excellent protection and performance in all 2-cycle injector or pre-mix non-VES applications.

OUR FORMULATION

- Synthetic Blend formula
- High lubricity
- Proprietary corrosion additive package

YOUR ADVANTAGE

- Excellent cold flow for easier starting down to -70° F (-40° C)
- Prevents rust and corrosion, ring sticking and plug fouling
- Lower total cost of ownership including extending the life of the engine

1 L
502571

4 L
502495

1000+
HOURS

DYNO TESTING

64,374
KILOMETERS

FIELD TESTING

WHAT COUNTS IN OIL TESTING:

1. Does it protect the engine at low temperatures?
2. Does it protect the engine from high heat wear?
3. Does it keep the engine clean?

PISTON CHECKPOINTS

PISTON DOME: Is it clean? Clean burning oil and our proprietary detergency system prevents carbon buildup and hot spots, which extends piston life and maintains optimal run quality.

PISTON RINGS AND RING LANDS:

Are they free of carbon deposits and soot? This is important to preserve ring seal and maximum power output.

PISTON PINS AND NEEDLE BEARINGS:

Proper viscosity and lubricity, film strength and our proprietary additives provide exceptional protection and heat control, maintaining proper pin and bearing tolerances and performance.

PISTON SKIRT: Is the Grafal coating scratched or visibly damaged? Harsh contact between the cylinder and piston due to insufficient lubrication would eventually result in engine failure.



ENGINEERED TO MAXIMIZE THE LIFE OF YOUR RIDE

All Polaris® fluids—from anti-freeze to brake fluid—are developed for your vehicle. Trust the only fluids perfectly engineered for your needs.



CARBON CLEAN

Polaris® Carbon Clean prevents ethanol corrosion, stabilizes fuel, and cleans carburetor jets and fuel injector nozzles, deposits on piston and rings, intake systems, and combustion chambers. Antioxidants preserve fuel and prevent fuel system gumming.

125 ml | 502528



SYNTHETIC CHAINCASE LUBE

Unlike typical gear case oils, SCL's unique viscosity range allows instant flow and film protection in extreme cold or high heat environments.

1L | 502560
25 L | 502561
201L | 502562



ANTI-FREEZE

Polaris® Extended Life Anti-Freeze contains organic acid technologies to prevent corrosion on metal components, eliminate scaling, and maximize cooling system performance.

1L | 502566
25 L | 502567
206 L | 502568



SHOCK OIL

1L | 502518



FUEL STABILIZER

- Advanced Fuel Treatment prevents ethanol corrosion and stabilizes fuel for up to 2 years. Dual-antioxidant formula protects against gum and varnish for easy starting

125 ml | 502100



DOT 4 BRAKE FLUID

Polaris® DOT 4 Brake Fluid is designed for use in Polaris® hydraulic brakes. Superior high-temp characteristics plus anti-corrosion additives extend the life of brake system components.

250 ml | 502526



OIL

Polaris® Blue, VES, and VES Extreme 2-cycle oils are tested to perform, and are the only oils developed specifically for your Polaris® snowmobile engine. Exclusive anti-wear additives protect engine parts with extra rust and corrosion protection.

2-Cycle oils Part numbers. See previous page.



ALL-SEASON GREASE

Polaris® All-Season Grease is designed to maintain consistency across a wide range of temperatures. Engineered to protect front and rear suspension components, steering bushings, and driveline bearings.

400 gr | 502538

CLEAN

ALL-PURPOSE CLEANER

- Professional grade, non-streak and biodegradable universal cleaner for the whole sled

500 ml | 502533



SHINE

INSTANT SHINE & DETAILER

- Quick and protective cleaning for a sparkling clean result. Polaris Instant Shine and Detailer does not need additional water! Ideal for plastics, glass, varnishes, metals as well as windscreens and visors

500 ml | 502546



Oil and cleaners featured are for EU distribution only. For other availability, contact your local dealer.

GARAGE ACCESSORIES



POLARIS SHOP TOWELS

200 ct with dispenser (shown)
2830402
200 ct refill | 2830403



FLUID FUNNEL

Easily add oil with high accuracy
2830552



FLUID TRAY

Holds up to 8 quarts of fluid
2830551



FLUID SYRINGE

Easily add and remove fluid from your vehicle like Synthetic Chain Lube
2830553



OIL CHANGE TOOL KIT

Kit Includes:
1- 6.5 Quart Drain Pan
1- 1 Pint Oil Funnel with Screen
1- Oil Filter Wrench
2- 15" x 18" Absorbent Pads
1- Clean Up Wipe
2- Pairs of 6 Mil Nitrile Gloves
4- Blue Interfold Shop Towels
2830545



1.5" x 15' 5,500 LB. RATCHET STRAP 2000KG

2
PAC

- Keep your Snowmobile, ATV or Ranger safely strapped at your trailer.
 - Dimension 3.5cm/ 50cm/ 550cm
 - Max load 2000kg/ working load 1000kg
 - 2 pac
- POL05031



OIL FILTER WRENCH

Remove 4-stroke engine oil filters with ease
2830550



2D BATTERY-OPERATED SIPHON PUMP

Liquid transfer pumps 5-6 quarts/min suctioning power
2830513



SNOW DOLLY

- 3" big-wheel caster design
 - Move your sled around the garage with ease
- 2882959



POLARIS MAGNETIC PARTS TRAY

Silver | 2830432



POLARIS 33" TELESCOPIC MAGNET

Black | 2830435



POLARIS 12" HI-TORQUE RATCHETING DRIVER

Black/Blue | 2830434



POLARIS LED POCKET FLASHLIGHT

Black | 2830436

GARAGE

MAINTENANCE

OIL

LUBRICANTS &
GARAGE ACCESSORIES

BELTS, HD PARTS
& BATTERY CHARGERS

SERVICE PARTS

POLARIS ENGINEERED DRIVE BELTS

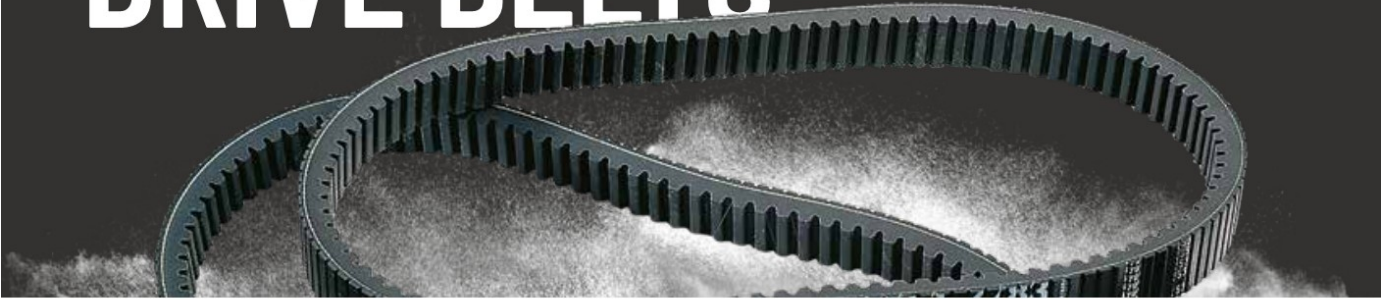

OUR INVESTMENT PER BELT

- 20,000 miles of field testing
- Thousands of dyno hours
- 18+ months of development (3,000+ design hours) per belt
- 1,200+ vehicle validation hours
- Collaboration with powertrain and clutch engineers

YOUR ADVANTAGE

- No clutch recalibration
- Less wear and tear due to heat
- Ensure maximum performance of your vehicle
- More time out riding, less time wrenching

BELT COMPOUND & CONSTRUCTION NOTES	BELT WIDTH*	OUTER CIRCUMFERENCE*	PART NUMBER
MATRYX/AXYS: RMK, RUSH, SWITCHBACK (ALL), VOYAGEUR, TITAN, INDY (ALL)			
High Modulus Chloroprene Belt	1.46" (37.10mm)	45.16"	3211215 (MY20-LATER 800CC / ALL 850CC)
High Modulus Chloroprene Belt	1.46" (37.10mm)	45.51"	3212325 (4-STROKE/850 BOOST TRAIL)
PBO Belt	1.46" (37.10mm)	45.16"	3211177 (800CC)
PBO Belt	1.46" (37.10mm)	45.16"	3211165 (600CC/650CC)
MATRYX/AXYS: PRO-RMK, RMK ASSAULT, SKS & KHAOS RMK			
High Modulus Chloroprene Belt	1.46" (37.10mm)	46.77"	3211216 (MY20-LATER 800CC/ALL 850CC/850BOOST/900)
PBO Belt	1.46" (37.10mm)	46.77"	3211183 (800CC)
PBO Belt	1.46" (37.10mm)	46.77"	3211115 (600CC/650CC)
PRO-RIDE: RUSH, SWITCHBACK, SWITCHBACK ASSAULT, INDY, VOYAGEUR, PRO-RMK, RMK, RMK ASSAULT			
PBO Belt	1.46" (37.10mm)	46.77"	3211115
KEVLAR® Belt	1.46" (37.10mm)	46.77"	3211122
KEVLAR® Belt	1.32" (33.53mm)	43.23"	3211174 (550CC)
Standard Belt	1.29" (32.77mm)	42.48"	3211154 (550CC)

FIND THE RIGHT BELT FOR YOUR MACHINE IN OUR ONLINE PARTS CATALOG AT [POLARIS.COM](https://www.polaris.com)

*Belt dimensions are given in nominal dimensions. There is a +/- variance for all critical dimensions. Clutch setup must be inspected when a new belt is installed and should be adjusted if necessary. The drive belt is an important component in the CVT system. In order to achieve maximum efficiency from the converter, drive-belt deflection (tension), clutch offset and alignment must be adjusted properly. See your service manual for further details on drive-belt measurement inspection.



HD HEAVY DUTY PARTS

All Polaris parts are developed and tested to help you get the most out of your ride. We're taking the passion of our riders to the next level with HD Parts.

ENGINEERED AND DESIGNED FOR:

- Greater durability
- Greater wear and tear capabilities
- Enhanced performance
- Extreme conditions



NEW
BRAKE PADS

Hayes race inspired PRT brake pads utilize proven technology and material that is warp resistant and provides a consistent feel in all temperature ranges and environments.

PART NUMBER	
OE	HD HEAVY DUTY PARTS
2204036	2209690
2205500	
2206251	

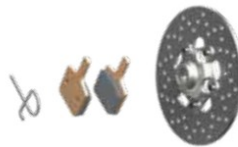

NEW
BRAKE PAD KIT

Easily update the entire brake system with HD Pads (2209690) and Hayes Pro-Float 5R Rotor to provide maximum performance.

PART NUMBER	
OE	HD HEAVY DUTY PARTS
2205373	2209691
2206235	

LEARN MORE AT
POLARIS.COM/HDPARTS

POLARIS ENGINEERED SERVICE PARTS DELIVER UNMATCHED PERFORMANCE AND FIT FOR YOUR SLED.

Our engineers at Polaris create snowmobile parts that push the limits of weight versus strength. We build our parts to feel lighter without sacrificing strength and durability. But over time, your sled will eventually need some service. When we're engineering our high-performance components, we keep serviceability in mind. From a quick clutch inspection to a ski alignment, we build our products as a system, so that anyone with the right tools and training can easily maintain their vehicle—and get back on the trails where your snowmobile belongs.

CHECK OUT OUR **PARTS FINDER ON POLARIS.COM**
FOR EASY PARTS LOOK UP, PARTS IDENTIFICATION, VIEWS OF ASSEMBLIES & MORE!

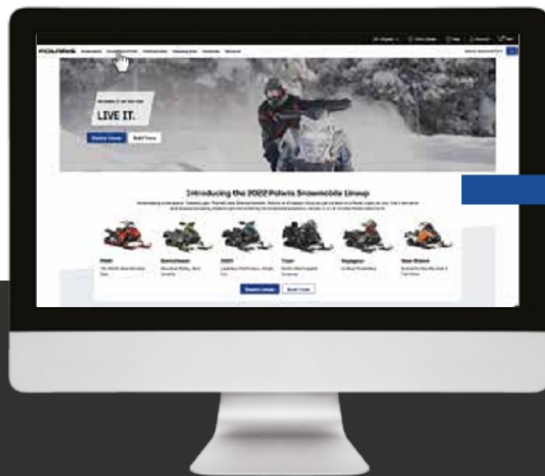

STEP 1

Visit snowmobiles.polaris.com
Click "Accessories & Parts" tab
Click "Parts & Maintenance"

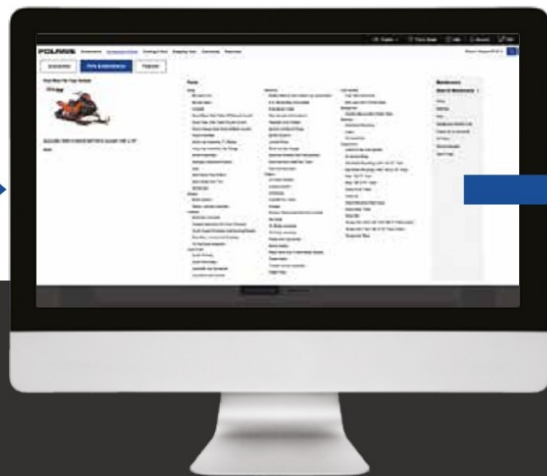

STEP 2

Enter **vehicle year/model**
or shop by **part number**

OVER
100,000
PARTS AVAILABLE!

Find helpful links, articles, and maintenance parts information.

ACCESS THE POLARIS HELP CENTER AT POLARIS.COM

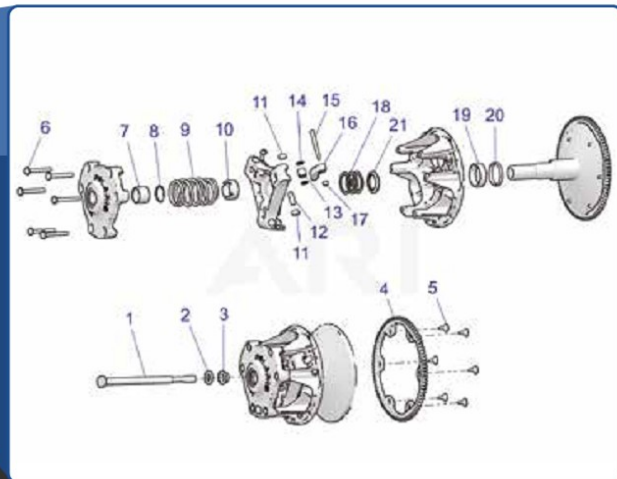
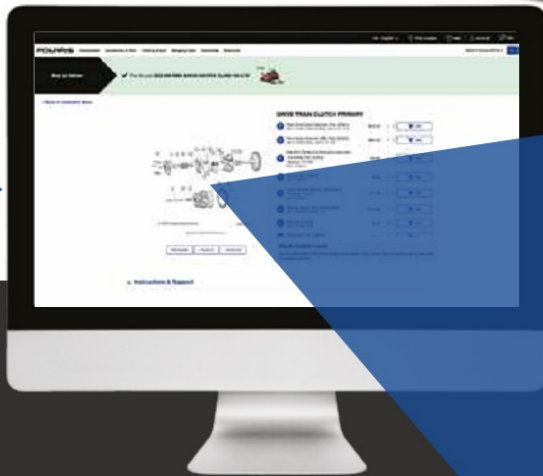

STEP 3

Clearly see what parts are required and **order**

SHOP FOR SERVICE PARTS
ONLINE OR VISIT YOUR POLARIS DEALER

GARAGE

MAINTENANCE

OIL

LUBRICANTS &
GARAGE ACCESSORIES
& BATTERY CHARGERS

SERVICE PARTS

SIZING GUIDE

MEN'S JACKET & BIB SIZING

SIZE	S	M	L	XL	2XL	3XL	4XL	5XL	MT	LT	XLT	2XLT
CHEST	34-36	38-40	42-44	46-48	50-52	54-56	58-60	62-64	38-40	42-44	46-48	50-52
SLEEVE*	33-35	33-35	34-35	34-35	34-35	34-35	34-35	34-35	33-35	34-35	34-35	34-35
WAIST	31-33	35-37	39-41	43-45	47-49	51-53	55-57	59-61	35-37	39-41	43-45	47-49
HIPS/SEAT	34-36	38-40	42-44	46-48	50-52	54-56	58-60	62-64	38-40	42-44	46-48	50-52
INSEAM	30-35	30-35	30-35	30-35	30-35	30-35	30-35	30-35	36-37	36-37	36-37	36-37

*MEASURE SLEEVE LENGTH FROM CENTER BACK NECK

WOMEN'S JACKET & BIB SIZING

SIZE	S	M	L	XL	2XL	3XL
CHEST	32-34	35-38	39-42	43-46	47-50	51-54
SLEEVE*	29-30	31-33	31-33	31-33	31-33	31-33
WAIST	26-28	29-32	33-36	37-40	41-44	45-48
HIPS/SEAT	35-37	38-41	42-45	46-49	50-53	54-57
INSEAM	26-29	27-30	27-30	27-30	27-30	27-30

HELMET SIZING GUIDE

SIZE	XS	S	M	L	XL	2XL	3XL	4XL	5XL
SIZE CODE	00	02	03	06	09	12	14	15	16
HAT SIZE	6 3/4	6 7/8-7	7 1/8-7 1/4	7-7 1/2	7 5/8-7 3/4	7 7/8-8	8	8 3/4	8 1/2
CIRCUMFERENCE	20 7/8"-21 1/4" (53-54cm)	21 5/8"-22" (55-56cm)	22 3/8"-22 3/4" (57-58cm)	23 1/8"-23 5/8" (59-60cm)	24"-24 3/8" (61-62cm)	24 3/4"-25 1/8" (63-64cm)	25 1/4"-26" (65cm)	26 3/8"-26 3/4" (66cm)	27 1/8"-27 1/2" (69-79cm)

APPAREL



FIDLOCK® MAGNETIC TECHNOLOGY

An easy-on and easy-off magnetic closure device that delivers a quick, secure helmet strap closure on select 509 helmets.



DOT & ECE 22.05 CERTIFIED

The Department of Transportation (DOT) standard is enforced by the National Highway Traffic Safety Administration (NHTSA). For a helmet to be DOT-certified, it must pass a series of impact tests.

The Economic Commission for Europe (ECE) standard, R 22.05, is the most common helmet standard used internationally, as it is recognized by over 50 countries. To be ECE 22.05 certified, the helmet must pass a series of rigorous tests by an independent third-party lab.



TECH54

A waterproof and breathable membrane bonded to the shell fabric to block moisture from entering while allowing vapor moisture to escape from the inside.



SUPERIOR DURABLE WATER REPELLENCY

A Superior DWR coating causes water to bead up and run off, preventing precipitation from saturating the exterior of an outerwear piece.



BOA® LACING SYSTEM

The BOA® lacing system is easier to get on and off than traditional lace-up boots. Simply push to engage, turn to tighten and pull for quick release.



3M® THINSULATE® INSULATION

3M® Thinsulate® Insulation is warm yet lightweight, powerful yet thin. It helps trap body heat while allowing moisture to escape.



3M® SCOTCHLITE® REFLECTIVE MATERIAL

Patented 3M® Scotchlite® Reflective Material provides nighttime visibility from every angle.



YKK® ZIPPERS

The YKK® Fastening Products Group is trusted worldwide for impeccable production standards and thorough quality control processes for slide fasteners, plastic hardware, hook-and-loop fasteners, webbing tapes and snap-and-button products.



MOUNTAIN APPAREL

Uninsulated outerwear made of TECH54 20k/20k or 10k/10k material.



CROSSOVER APPAREL

Insulated outerwear made of TECH54 10k/10k material.



TRAIL APPAREL

Insulated outerwear made of TECH54 5k/5k material.

ACCESSORIES + GARAGE



LOCK & RIDE

For Snow Accessories, a T-Slot tunnel attachment system.



CAMSO®

Customer-focused, world-class manufacturer and supplier of high-performance snowmobile tracks.



LOCK & RIDE FLEX

The fastest attachment system designed for tunnel-mounted snow accessories. Adapter kit sold separately to update a Lock & Ride attachment system to the Lock & Ride Flex system.





POLARIS MY23 LINEUP



RMK



**SNOW
CHECK**
EXCLUSIVE MODELS

9R RMK KHAOS SLASH 155



**SNOW
CHECK**
EXCLUSIVE MODELS

9R RMK KHAOS SLASH 146



**SNOW
CHECK**
EXCLUSIVE MODELS

PATRIOT BOOST SLASH RMK KHAOS 155



850 RMK KHAOS SLASH 155

MOUNTAIN

RMK



850 RMK KHAOS SLASH 146



850 RMK KHAOS SLASH 146



850 RMK KHAOS 155



650 SKS 146

MOUNTAIN

INDY



PATRIOT BOOST INDY VR1 137



850 INDY VR1 137



850 INDY XCR 136



650 INDY XCR 136

PERFORMANCE

SWITCHBACK



PATRIOT BOOST SWITCHBACK ASSAULT 146



850 SWITCHBACK ASSAULT 146



650 SWITCHBACK ASSAULT 146

INDY



120 INDY

PERFORMANCE

YOUTH

TITAN



PROSTAR S4 TITAN ADVENTURE 155



800 TITAN ADVENTURE 155

NORDIC PRO



PROSTAR S4 NORDIC PRO 146



650 NORDIC PRO 146

CROSSOVER

LIGHT UTILITY

Reserveation regarding printer errors, deviation from the written content and color deviation in the depicted material.

POLARIS | SNOWMOBILES