



**POLARIS**

**2024**

**SNOW APPAREL,  
ACCESSORIES  
& GARAGE**



SKANDINAVIAN VERSION

**POLARIS**  
**ENGINEERED**

Everything in our Snow Apparel, Accessories and Garage lineup is designed to optimize your experience on every ride. Stay warm and dry in our technical apparel for a more enjoyable ride. Customize your sled for your individual riding style with our collection of accessories. By using Polaris Engineered Parts & Lubricants, your sled will deliver peak reliability and performance, season after season.



## DESIGNED

Developed by the same engineers who built your sled.

## TESTED

Proven in grueling winter conditions around the world.

## TRUSTED

Over 65 years of building the world's best snowmobiles.



**RMK**

THE WORLD'S BEST PURPOSE-BUILT MOUNTAIN SLEDS.



**SWITCHBACK**

GO-ANYWHERE MULTI-TERRAIN PERFORMANCE.



**INDY**

REDEFINING TRAIL PERFORMANCE.



# 2024

## APPAREL

- 6 Riding Gear 101
- 8 TECH54
- 10 Polaris Heated Apparel
- 12 Men's Apparel
- 32 Women's Apparel
- 40 Youth Apparel
- 44 Helmets
- 48 Goggles
- 50 Rider Safety
- 54 Gloves
- 56 Boots, Balaclavas & Luggage
- 58 Home & Collectibles

## ACCESSORIES

- 64 Lock & Ride Flex
- 66 Covers
- 68 Polaris Partners
- 70 Connected Technology
- 72 MATRYX
- 86 AXYS
- 102 PRO-RIDE
- 108 Ride Readiness
- 110 Hitches
- 112 Transport
- 114 Traction & Control
- 116 Tracks

## GARAGE

- 122 Maintenance
- 124 Oil
- 128 Lubricants & Garage Accessories
- 130 Belts, HD Parts & Battery Chargers
- 131 Battery Charger
- 132 Service Parts



## TITAN

HARDEST WORKING,  
MOST FUN WIDETRACK.



## VOYAGEUR

WORK. EXPLORE.  
DO MORE.

EXPLORE OUR FULL LINEUP  
[POLARIS.COM](https://www.polaris.com)

# APPAREL

## FIT FOR ANY ADVENTURE.

For outdoor enthusiasts looking for gear that's purposefully built to stand up to the fun and challenging experiences Polaris vehicles enable. Each piece of apparel and equipment bearing the Polaris name is crafted by outdoor enthusiasts, for outdoor enthusiasts. They are a badge of honor—representing what the Polaris brand stands for—a passion to simply be outside doing what you love. Polaris Apparel is rider-inspired and tested under real-world extremes so it's ready for anything the outdoors will throw at it.

### APPAREL CONTENTS

- 6 Riding Gear 101
- 8 TECH54
- 10 Polaris Heated Apparel
- 12 Men's Apparel
- 32 Women's Apparel
- 40 Youth Apparel
- 44 Helmets
- 48 Goggles
- 50 Rider Safety
- 54 Gloves
- 56 Boots, Balaclavas & Luggage
- 58 Home & Collectibles



**TECH54**





# DESIGNED BY RIDERS FOR RIDERS

Polaris Engineered Riding Gear is high-quality outdoor gear designed for a wide range of riders, riding styles and other outdoor activities. It is intentionally designed to work together as a smart solution with the best fit and optimal comfort so that you can stay out longer, doing what you love.

**TECH54**

Every Polaris riding jacket, bib, monosuit and boot is made with TECH54, an exclusive technology from Polaris. TECH54 is a waterproof and breathable membrane that locks out moisture, and lets body vapor escape, to keep you warm, dry and comfortable. Visit P. 8 to learn more.

## HELMET

### FACE THE DAY WITH CONFIDENCE.

The ideal snowmobile helmet will offer proper fit, all-day comfort and personal style—to inspire confidence when you're out there carving powder.

## GOGGLES

### EVERY DAY. ANY CONDITION.

We offer a range of styles to fit your look and lens color options to enhance your vision in virtually any light condition you'll encounter—helping you pick out obstacles earlier and reduce eye strain.

## JACKET **TECH54**

### OWN THE EXTREMES.

All of our riding jackets are purpose built by our own team of technical experts to provide cold weather comfort, flexibility and a wide range of motion. Select the jacket that is best for your riding conditions with the right amount of warmth and breathability.

## BIBS **TECH54**

### LIVE IN YOUR ELEMENT.

Warmth, comfortable fit, and flexibility are key in choosing the right bibs. Polaris bibs provide a wider range of motion in the knees, thighs and waist to move with you as you ride.

## BALACLAVA

### SHIELD THE ELEMENTS.

Keep your face and neck protected from harsh conditions with a balaclava. These are intentionally designed to keep you warm and comfortable with windproof material and an anti-fog design.

## LAYERING

### LAYER ON THE WARMTH.

Choose the right layers for your conditions. Start with our moisture-wicking base layers to help maintain proper body temperature, then add middle insulating or a heated layer depending on the weather.

## GLOVES

### GRAB HOLD OF THE ADVENTURE.

All Polaris Engineered gloves are designed to keep the bitter cold out using a powerful combination of insulated materials and moisture-wicking linings while giving you a firm, confident grip on any situation.

## BOOTS **TECH54**

### PERFORMANCE, WARMTH AND COMFORT.

Cold feet ruin more snowmobile rides than anything else. Stay warm and dry all day with the Switchback 2.0 Boot which features hypergrip traction and a BOA® lacing system for easy on and off.



**RIDER SAFETY** **PIEPS**

**AVALANCHE SAFETY EQUIPMENT  
CRITICAL FOR MOUNTAIN RIDERS.**

See P. 50 for more information.

## THE RIGHT GEAR FOR HOW YOU RIDE.

Polaris Engineered riding gear is specifically designed for your riding style with different levels of warmth, breathability and versatility. Find the best gear for you based on the type of riding you do most. Ride in style with colors that match your sled and your personality.

Scan the QR codes below to explore the full lineup of riding gear for your type of riding.



**Trail Gear**  
Insulated riding gear with exceptional warmth and minimal bulk



**Crossover Gear**  
Versatile riding gear for any condition



**Mountain Gear**  
Uninsulated and breathable riding gear for aggressive riding



## RETRO COLLECTION

Inspired by our heritage on the trail

2833058	Northstar Bibs - Black	P. 18
2862480	Titan Leather Glove	P. 54



## SWITCHBACK COLLECTION

The versatility to do it all

2861467	Delta R3L Helmet - Back	P. 46
2833050	Tactical 2.0 Helmet - Pink	P. 46
2864512	Women's Switchback Bib - Black	P. 35
2861462	Northstar Glove	P. 54



## APEX COLLECTION

For the backcountry beast

2833155	Sinister X7 Goggle - Stealth	P. 48
2862436	Apex Jacket - Black	P. 14
2862574	Apex Bib - Black	P. 14
2861459	Revelstoke Glove	P. 55

# TECH54

## TECHNOLOGY TO **OWN THE EXTREMES**

**ELEVATE YOUR RIDE WITH EXCLUSIVE TECH54 RIDING GEAR DESIGNED TO KEEP YOU WARM AND DRY.**

Our Apparel Center of Excellence developed TECH54—a waterproof, breathable membrane featured in every Polaris jacket, bib and monosuit. This exclusive technology allows perspiration to escape and keeps water out, so no matter how you ride, or where you ride, you stay dry, warm and comfortable.





## WATERPROOF/BREATHABLE

TECH54 is our single-layer bonded laminate technology that brings waterproof breathability and riding comfort to a new level in every Polaris jacket and bib.

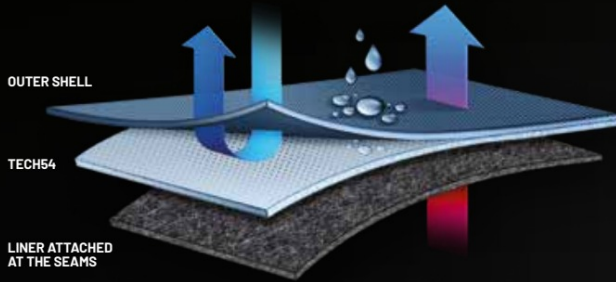

### DWR

## RESIST MOISTURE

Every Polaris jacket and bib is treated with a DWR (Durable Water Repellent) coating to prevent precipitation from saturating the outer fabric, so your gear doesn't get soggy. The DWR coating causes water to bead up and run off, keeping you comfortable and dry.

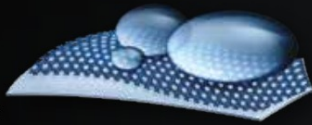

## 3M Scotchlite<sup>™</sup> Reflective Material

## RIDE SAFER

Proven in every weather condition, patented 3M<sup>®</sup> Scotchlite<sup>®</sup> Reflective Material is placed meticulously on each garment and nighttime tested to provide visibility from every angle.

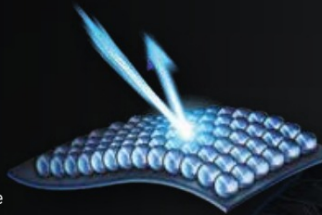

## YKK<sup>®</sup> ZIPPERS

## STAY PROTECTED

Quality construction you can trust.



## 3M<sup>®</sup> Thinsulate<sup>®</sup> INSULATION

## BE WARMER

3M<sup>®</sup> Thinsulate<sup>®</sup> Insulation is zonally mapped on insulated apparel to provide extra insulation in high wind exposure areas.

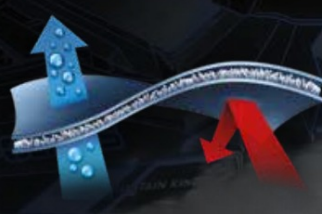

## HOW IT WORKS TO ELEVATE YOUR RIDE.

5k/5k, 10k/10k OR 20k/20k

## WATERPROOF

The first number (5k, 10k or 20k) refers to the waterproof rating.

## BREATHABILITY

The second number (5k, 10k or 20k) refers to how much water vapor the material can expel through the outerwear to release heat—and keep you dry from the inside.

## DIFFERENT RATINGS FOR DIFFERENT RIDES

Choose your TECH54 rating based on the weather conditions and your level of exertion.

**5k/5k:** best for colder and drier conditions and moderate activity

**10k/10k:** best for wet riding conditions and high-activity riding

**20k/20k:** best for extremely wet riding conditions and the most aggressive riding



DIVE DEEPER INTO TECH54 AT [POLARIS.COM/TECH54](https://Polaris.com/TECH54)

# POLARIS HEATED APPAREL

Keep warm even on the coldest days with Polaris Heated Apparel. By keeping the heat close to your body, you can stay out longer on all your winter adventures. The Polaris Heated Apparel lineup includes the Heated Vest, Heated Base Layers, and a Heated Glove Liner for both men and women. Easily control your heat setting with the touch of a button.

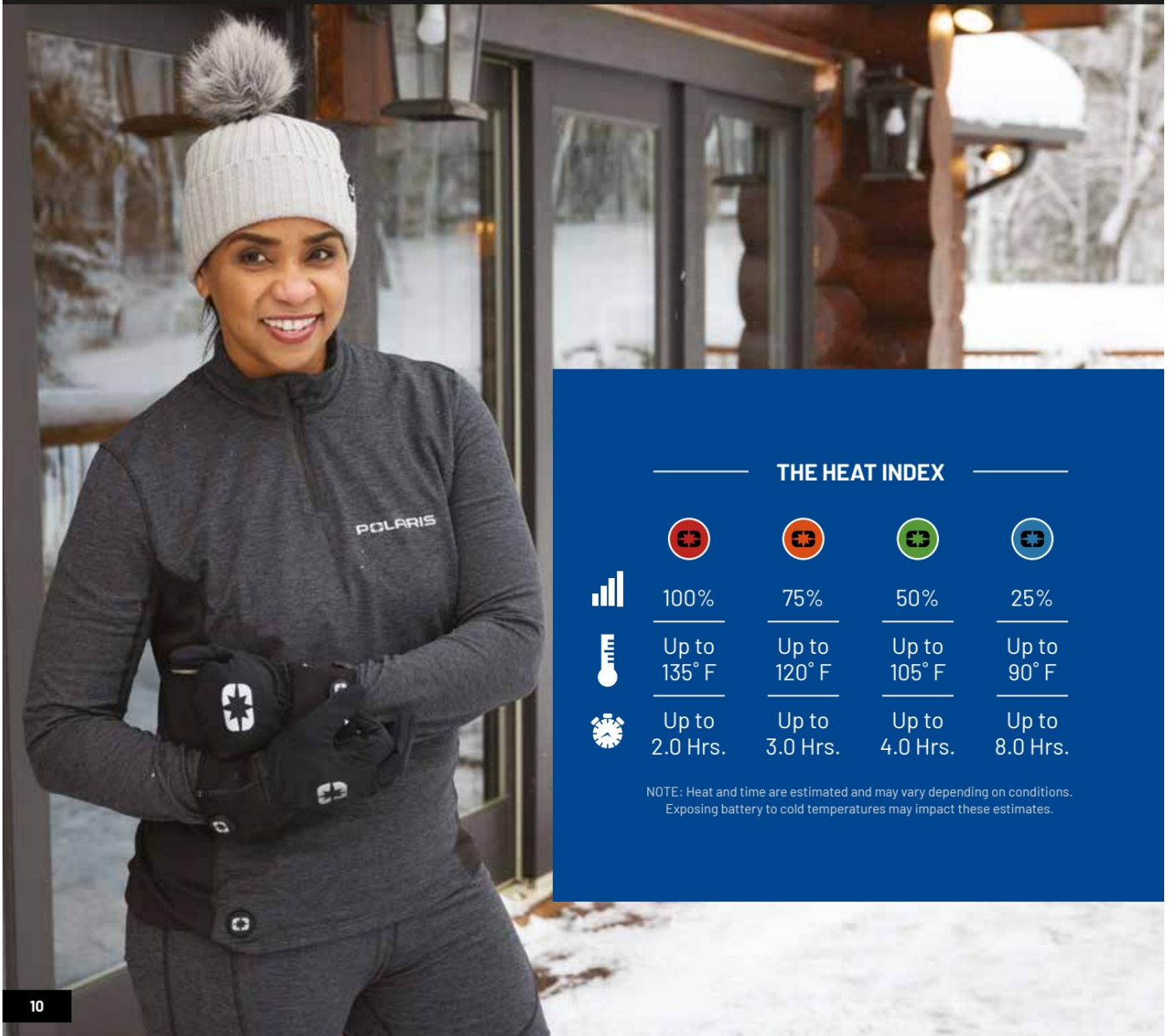

## THE HEAT INDEX

				
	100%	75%	50%	25%
	Up to 135° F	Up to 120° F	Up to 105° F	Up to 90° F
	Up to 2.0 Hrs.	Up to 3.0 Hrs.	Up to 4.0 Hrs.	Up to 8.0 Hrs.

NOTE: Heat and time are estimated and may vary depending on conditions. Exposing battery to cold temperatures may impact these estimates.

## THE HEATED ADVANTAGE

The Polaris Heated Apparel lineup features lightweight, moisture wicking fabric infused with stretch panels and a chafe free waistband to give you the most comfortable layering to wear on all of your cold weather adventures, on or off the trail.

Our lineup has multiple heat panels for evenly distributed heat for maximum warmth and comfort. Easily adjust between 4 heat settings for changing weather conditions with built-in buttons.

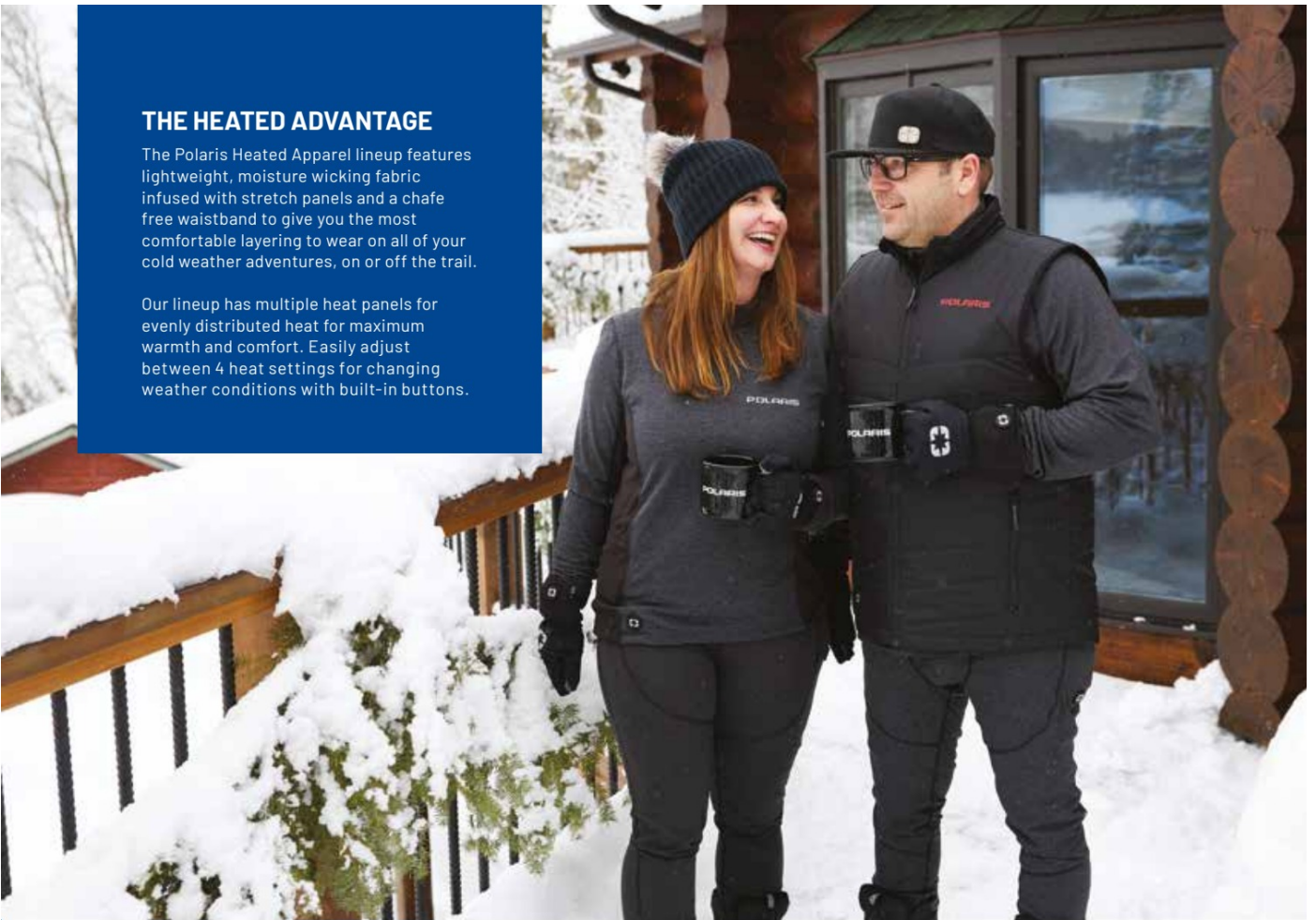

**HEATED VEST** ★ TOP SELLER

<b>MEN'S</b>	<b>WOMEN'S</b>
S-3XL   2833022	S-3XL   2833036
P. 20	P. 36



**HEATED BASE LAYERS** ★ TOP SELLER

<b>MEN'S</b>	<b>WOMEN'S</b>
Top   2833031	Top   2833033
Bottom   2833032	Bottom   2833034
P. 21	P. 36



**HEATED GLOVE LINER** ★ TOP SELLER

**UNISEX**  
S-3XL | 2833044



# MEN'S RIDING GEAR

Our innovative designs and advanced technical materials keep you warm, dry, and happy - head to toe - on every ride. TECH54 jackets, bibs, and monosuits provide ultimate protection and comfort for every type of rider. And our helmets offer styles, designs, and features just right for the way you ride.



# LAYERING

Anyone can layer up. But the key to staying warm and comfortable is picking the right layers for the conditions. Start with our moisture-wicking base layers to help maintain proper body temperature, then add a middle insulating or heated layer depending on the conditions.



# LIFESTYLE

Polaris hats, tees and jackets show others how you choose to live your life. This is well-crafted clothing that's purpose-built to keep you comfortable outdoors—right where you want to be.



TECH54



BLACK/LIME  
S-3XL  
2862436



BLACK  
S-3XL | MT-2XLT  
2862574  
AVAILABLE IN TALL

20K/20K



3M Scotchlite®  
Reflective Material

YKK®  
ZIPPERS

# APEX

## JACKET

ADVANCED UNINSULATED JACKET OFFERS MAXIMUM WATERPROOFNESS AND BREATHABILITY

- Three-layer stretch woven fabric for ultimate freedom of movement
- Features TECH54 Pro bonded internal laminate with 20k/20K internal properties
- Three external pockets (two hand, one chest)
- Two pit vents to help circulate air to keep you cool
- Shock-cord adjustable bottom hem, integrated snow skirt, and hand gaiters keep snow out
- Highly visible in low light conditions with 3M® Scotchlite® Reflective Material

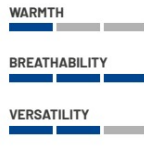

UNINSULATED

## BIB

ADVANCED UNINSULATED BIB OFFERS MAXIMUM WATERPROOFNESS AND BREATHABILITY WITH ENHANCED PROTECTION

- Three-layer stretch woven fabric for ultimate freedom of movement
- 300 denier reinforcements in high impact areas with built-in kneepads for ultimate protection
- Features TECH54 Pro bonded internal laminate with 20k/20K internal properties
- Two inner-thigh vents
- Two-way zipper
- Storm cuffs with boot-lace retention snaps
- Highly visible in low light conditions with 3M® Scotchlite® Reflective Material

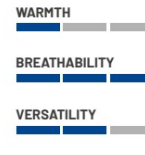

UNINSULATED



TECH54



NEW  
DARK BLUE  
S-3XL  
2864500

20K/20K



3M Thinsulate INSULATION

3M Scotchlite Reflective Material

YKK ZIPPERS

# BACKCOUNTRY MONOSUIT

ADVANCED INSULATED ONE-PIECE FOR WARMTH IN ANY RIDING CONDITION, ENABLES FREE RANGE OF MOTION AND PREVENTS SNOW INTRUSION TO KEEP YOU DRY AND COMFORTABLE

- Durable 150 denier poly shell is tear- and snag-resistant and treated with superior DWR to shed snow and water from the outer shell
- Features TECH54 bonded internal laminate with 20k/20k properties
- One-piece construction ensures powder stays on the outside
- 4-way stretch material allows for extreme mobility and comfort
- Increased storage including four external pockets (two hand, one chest, one thigh)
- 140g 3M® Thinsulate® Insulation

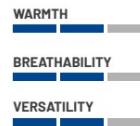

INSULATED

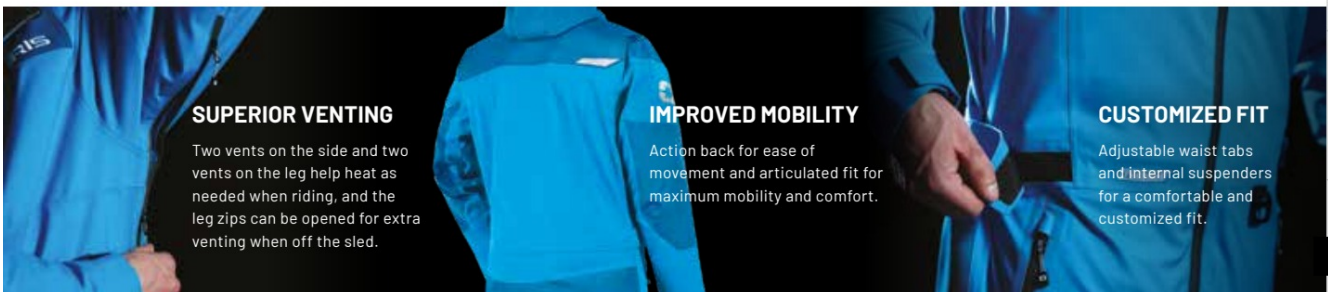

### SUPERIOR VENTING

Two vents on the side and two vents on the leg help heat as needed when riding, and the leg zips can be opened for extra venting when off the sled.

### IMPROVED MOBILITY

Action back for ease of movement and articulated fit for maximum mobility and comfort.

### CUSTOMIZED FIT

Adjustable waist tabs and internal suspenders for a comfortable and customized fit.



MEN'S CROSSOVER GEAR

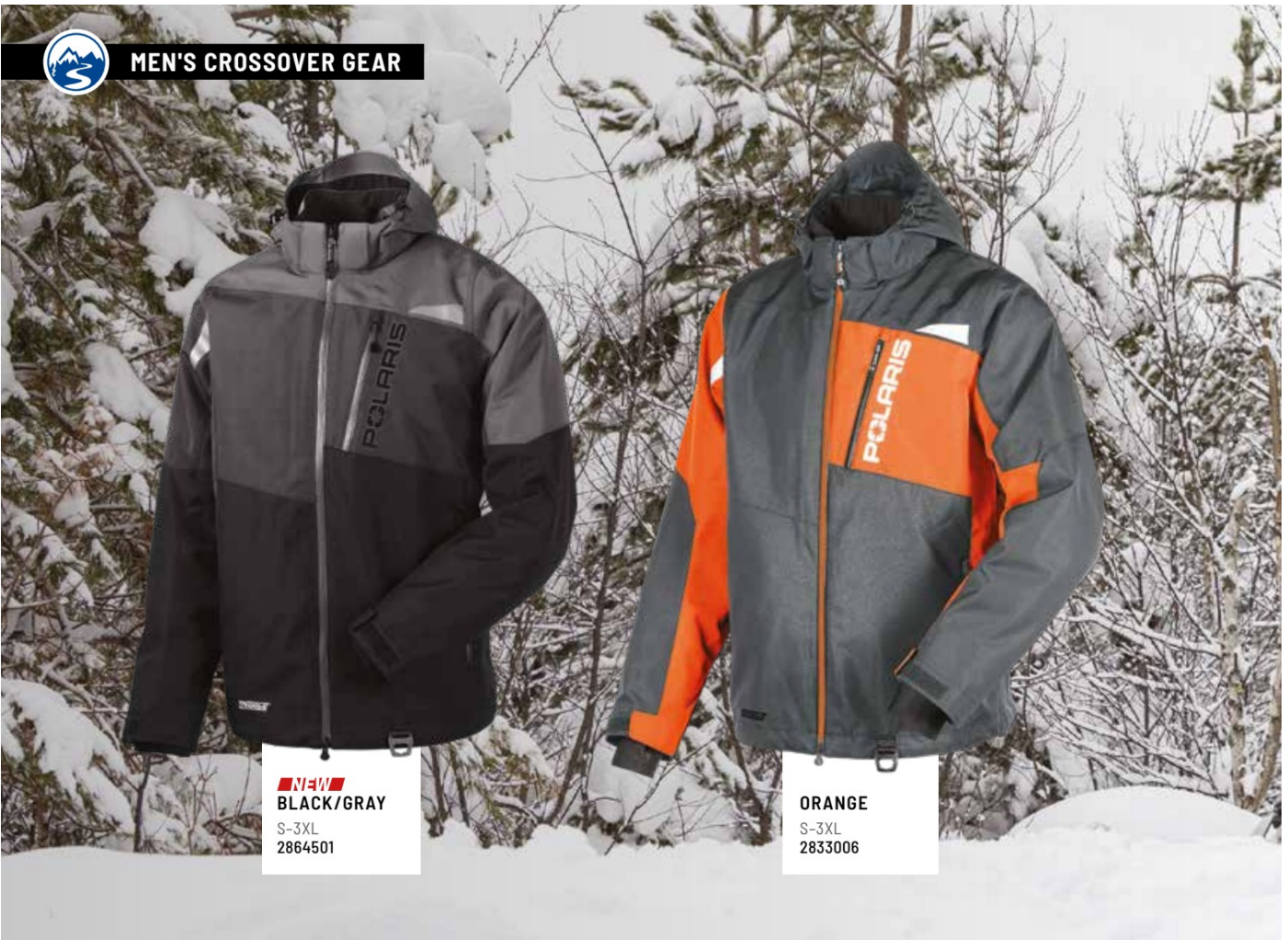

**NEW**  
BLACK/GRAY  
S-3XL  
2864501

ORANGE  
S-3XL  
2833006

10K/10K



# SWITCHBACK

## JACKET

### QUICK-CHANGE VERSATILITY WITH DURABLE SHELL AND REMOVABLE ZONAL INSULATED LINER

- Durable 300 denier poly shell is tear- and snag- resistant and treated with superior DWR to shed snow and water from the outer shell
- Features TECH54 bonded internal laminate with 10k/10k properties
- Removable insulated liner with 150g insulation in body and 100g in arms
- Shock-cord adjustable bottom hem to keep snow out
- Removable/adjustable hood
- Highly visible in low light conditions with 3M® Scotchlite® Reflective Material

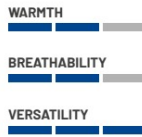

INSULATED



### MAXIMUM VERSATILITY

Remove the insulated liner without sacrificing waterproof breathability, while increasing versatility for changing ride conditions.



TECH54

APPAREL

MEN'S APPAREL

WOMEN'S APPAREL

YOUTH APPAREL

HELMETS

GOGGLES

RIDER SAFETY

GLOVES

BOOTS, BALACLAVAS,  
& LUGGAGE

HOME & COLLECTIBLES



**NEW**  
**BLACK**

S-3XL | MT-2XLT  
2864503

AVAILABLE IN TALL

## BIB/PANT

### VERSATILE BIB FEATURES ZONAL INSULATION AND EASY CONVERSION TO PANTS

- Durable 300 denier poly shell is tear- and snag-resistant and treated with superior DWR to shed snow and water from the outer shell
- Features TECH54 bonded internal laminate with 10k/10k properties
- Insulated with 120g insulation in front and 80g in back
- Two inner-thigh vents
- Two-way front zipper
- Storm cuffs with boot-lace retention snaps
- Removable suspenders allow bib to be converted to an adjustable waist pant
- Highly visible in low light conditions with 3M® Scotchlite® Reflective Material

WARMTH



BREATHABILITY



VERSATILITY



INSULATED



MEN'S TRAIL GEAR

TECH54



BLACK  
S-3XL  
2833000



**NEW**  
RED  
S-3XL  
2864505



BLACK  
S-3XL | MT-2XLT  
2833058  
AVAILABLE IN TALL

5k/5k



3M Thinsulate INSULATION

3M Scotchlite Reflective Material

YKK ZIPPERS

# NORTHSTAR

## JACKET

INSULATED JACKET PROVIDES GREAT WARMTH WITH MINIMAL BULK AT INCREDIBLE VALUE

- Durable 300 denier poly shell is tear- and snag-resistant and treated with superior DWR to shed snow and water from the outer shell
- Features TECH54 bonded internal laminate with 5k/5k properties
- Insulated with 180g insulation in body and 100g in arms
- Shock-cord adjustable hem to keep snow out
- Highly visible in low light conditions with 3M<sup>®</sup> Scotchlite<sup>®</sup> Reflective Material

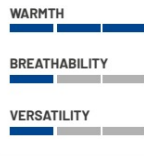

INSULATED

## BIB

ZONAL INSULATION PROVIDES GREAT WARMTH WITH MINIMAL BULK AT AN INCREDIBLE VALUE

- Durable 300 denier poly shell is tear- and snag-resistant and treated with superior DWR to shed snow and water from the outer shell
- Features TECH54 bonded internal laminate with 5k/5k properties
- Insulated with 180g insulation in upper front of legs and lower back and 100g on upper backside
- Two-way front zipper
- Storm cuffs with boot-lace retention snaps
- Highly visible in low light conditions with 3M<sup>®</sup> Scotchlite<sup>®</sup> Reflective Material

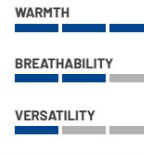

INSULATED



**BLACK**  
S-3XL | MT-2XLT  
2862429  
AVAILABLE IN TALL

5k/5k



3M **Thinsulate**  
INSULATION

3M **Scotchlite**  
Reflective Material

**YKK**  
ZIPPERS

# TITAN

## JACKET

ADVANCED INSULATED JACKET WITH ENHANCED DURABILITY AND SUPERIOR WARMTH TO OUTLAST THE ELEMENTS

- Durable 600 denier Cordura® Outer Fabric is tear- and snag-resistant and treated with DWR to shed snow and water from the outer shell to keep you dry
- Features TECH54 bonded internal laminate with 5k/5k properties
- Insulated with 300g insulation in body, 220g in arms, and 100g in collar
- Ample storage with three external pockets and 2 internal pockets
- Shock-cord adjustable hem and snow skirt to keep snow out
- Highly visible in low light conditions with 3M® Scotchlite® Reflective Material

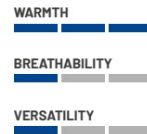

INSULATED

APPAREL

MEN'S APPAREL

WOMEN'S APPAREL

YOUTH APPAREL

HELMETS

GOGGLES

RIDER SAFETY

GLOVES

BOOTS, BALACLAVAS, & LUGGAGE

HOME & COLLECTIBLES

**MEN'S LAYERING**



**BLACK/GRAY**  
S-3XL | 2862565

**REVOLVE VEST**

REVERSIBLE

DURABLE AND WARM REVERSIBLE VEST OFFERS TWO STYLES IN ONE

- Durable windbreak outer fabric helps protect from the elements
- 140g 3M® Thinsulate® Insulation keeps you warm in cold weather
- Vest is reversible

**NEW**  
**HEATED APPAREL REPLACEMENT BATTERY PACK**

- Compatible with Polaris Men's & Women's Heated Base Layer Tops, Bottoms & Heated Vests
- Includes: 7.4V Lithium-Ion Battery with two 7.8V chargers (110V wall and 12V port)

2864582



**BLACK**  
S-3XL | 2833022

**HEATED VEST** ★ TOP SELLER

WARMTH WITH THE TOUCH OF A BUTTON

- Perfect for any outdoor activity
- Down-proof machine washable material with 160g of insulation for warmth with or without the heater turned on
- Powered by a small rechargeable battery (included) that can also be used to charge a cellphone; Battery not machine washable, remove prior to washing
- Easily adjust between 4 heat settings for changing weather conditions with built-in buttons

## MEN'S BASE LAYERS

Quick-drying and quick-wicking. Rests against your skin to regulate your overall body temperature by wicking away moisture.

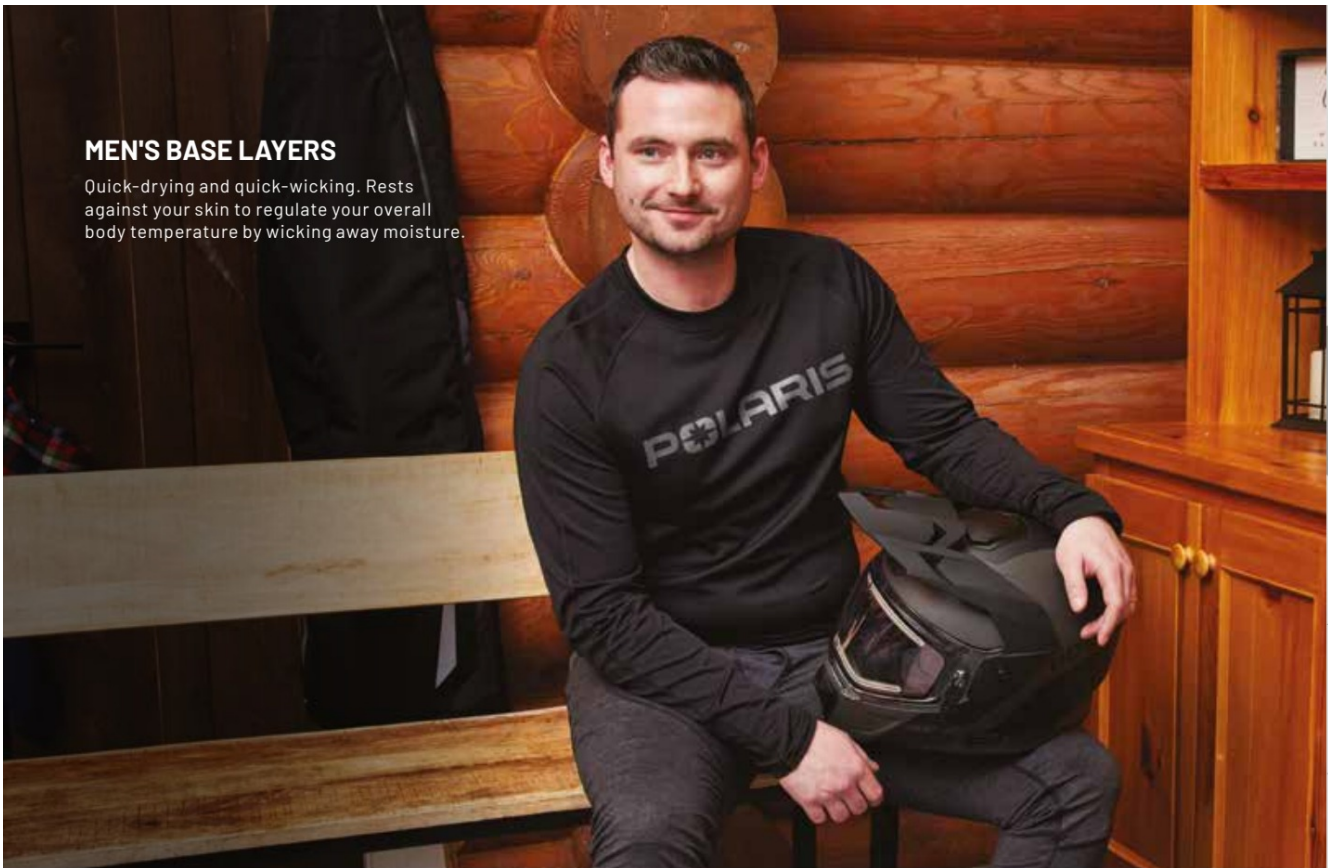

### HEATED BASE LAYER \* TOP SELLER

ADJUSTABLE HEAT CLOSE TO YOUR BODY, MAXIMUM COMFORT IN CHANGING CONDITIONS

- Intended for use as a base layer
- Features lightweight, moisture-wicking fabric to give you the most comfortable layering to wear on all of your cold weather adventures, on or off the trail
- Includes multiple heat panels for evenly distributed heat for maximum warmth and comfort
- Powered by a small rechargeable battery (included) that can be used to charge a cellphone; Battery not machine washable, remove prior to washing
- Easily adjust between 4 heat settings for changing weather conditions with built-in buttons

WARMTH  
  
 ADJUST FROM LEVEL 1 TO 4 WARMTH WITH THE TOUCH OF A BUTTON

### MIDWEIGHT BASE LAYER

LIGHTWEIGHT, COMFORTABLE, MOISTURE-WICKING BASE LAYER

- Comfortable stretch fabric to allow for maximum movement
- 92% polyester, 8% spandex
- 220g fleece lined brushed fabric provides comfort and warmth

WARMTH  

**MEN'S LAYERING**

**MEN'S MID-LAYERS**

Insulating layers for the right level of warmth for your riding conditions.



**ORANGE**  
S-3XL | 2833025



**GRAY**  
S-3XL | 2862576



**BLACK**  
S-3XL | 2862522

**ROSEAU QUARTER-ZIP SWEATER**

CASUAL LOOK & FEEL AND IS PERFECT AS A LIGHT MID-LAYER

- Wear this lightweight quarter-zip on a casual day to look and feel good
- A blend of cotton and polyester make this shirt comfortable to wear



**TECH QUARTER-ZIP** TOP SELLER

FLEECE LINED MID-LAYER FOR ESSENTIAL WARMTH WHILE RIDING WITH THE STYLE AND COMFORT TO WEAR ANYWHERE

- Fleece-lining keeps you cozy and warm
- Move freely with four-way stretch material
- Contoured, slim fit



**BLUE**  
S-3XL | 2833023



**BLACK/GRAY**  
S-3XL | 2862622

**SWITCHBACK MID-LAYER**

BATTLE THE COLD WITHOUT THE BULK AND SLIDE YOUR JACKET ON EASILY

- 280g of breathable fleece and a wear-resistant, sleek polyester face
- Inner spandex layer enhances fit without restricting movement
- Hand pockets perfect for mid-day stops when you remove your outer shell





**NEW**  
BLUE

S-3XL | 2864525

BLACK/LIME

S-3XL | 2833024

TAN

S-3XL | 2862450

BLUE/ORANGE

S-3XL | 2862567

**NORTHSTAR MID-LAYER** ★ TOP SELLER

**EXTREMELY WARM YET BREATHABLE  
MID-LAYER, PERFECT FOR RIDING**

- 280g of breathable fleece for added warmth
- Offers durable protection against the elements with a wear-resistant polyester face and wind-block layer on chest
- Designed to fit under outer shell when riding

WARMTH



**TITAN MID-LAYER**

**VERSATILE MID-LAYER CAN BE WORN  
ALONE OR AS AN EXTRA LAYER**

- 319g Polartec® Thermal Pro® Rib Sweater provides great warmth
- Breathable material moves sweat to the outer surface
- Nylon overlay is comfortable and light

WARMTH



## MEN'S LIFESTYLE



**NEW**  
**CYPRESS**

S-3XL | 2864517

**BLUE**

S-3XL | 2833028

**BLACK**

S-3XL | 2861434

**NEW**  
**BLUE**

S-3XL | 2864518

**GRAY/RED**

S-3XL | 2833029

### SOFTSHELL JACKET ★ TOP SELLER

VERSATILE LIGHTWEIGHT JACKET THAT'S PERFECT FOR EVERYDAY WEAR

- Casual jacket armed with rugged and warm features for everyday wear
- Superior DWR prevents precipitation from saturating the jacket's exterior
- Lined with soft fleece for warmth
- Removable hood and underarm venting, three external pockets and one internal chest pocket

### FORCE PUFFER JACKET

PACKABLE JACKET OFFERS LIGHTWEIGHT PROTECTION AND INCREDIBLE WARMTH

- 140g 3M® Thinsulate®
- Two external hand pockets
- One internal media pocket
- Rugged YKK® zippers
- Compactable into travel pocket



**CYPRESS**

S-3XL | 2864672

**NEW**  
**PLAID FLANNEL SHIRT**

COMFORTABLE YET DURABLE WITH A CLASSIC FIT, PERFECT FOR ANY OCCASION

- Exclusive plaid design
- 100% cotton brushed flannel shirt
- Two pocket-shirt silhouette



**POLARIS**  
RACING

**TEAM POLARIS IS PUSHING RACING TO THE LIMIT.**

Show your passion for the thrill with our lineup of Polaris Racing apparel.

POLARIS  
OWNER  
PARKING

POLARIS  
RACING



**NEW**  
**POLARIS RACING FULL ZIP HOODIE**  
Black | S-3XL | 2864594



**NEW**  
**POLARIS RACING TEE**  
Black | S-3XL | 2864619

APPAREL

MEN'S APPAREL

WOMEN'S APPAREL

YOUTH APPAREL

HELMETS

GOGGLES

RIDERS SAFETY

GLOVES

BOOTS, BALACLAVAS,  
& LUGGAGE

HOME & COLLECTIBLES

25

**MEN'S LIFESTYLE**



**NEW**  
**UPF HOODIE TEE**  
 Blue | S-3XL | 2833072



**NEW**  
**HERITAGE CREW NECK SWEATSHIRT**  
 Navy | S-3XL | 2864624



**ICON HOODIE** ★ TOP SELLER  
**NEW** Red | S-3XL | 2864592  
**NEW** Blue | S-3XL | 2864593  
 Black/Red | S-3XL | 2833065  
 Gray | S-3XL | 2862487



**TECH FULL-ZIP HOODIE**  
**NEW** Blue | S-3XL | 2864531  
 Gray | S-3XL | 2861493



**ROGUE HOODIE** ★ TOP SELLER  
**NEW** Blue | S-3XL | 2864587  
 Black | S-3XL | 2833062  
 Navy | S-3XL | 2833063



**JOURNEY HOODIE**  
**NEW** Cypress | S-3XL | 2864536  
 Black | S-3XL | 2862489



**CREW SWEATSHIRT** ★ TOP SELLER  
**NEW** Green | S-3XL | 2864632  
**NEW** Navy | S-3XL | 2864633  
 Gray | S-3XL | 2833067  
 Black | S-3XL | 2862488



**STAPLE HOODIE** ★ TOP SELLER  
Black | S-3XL | 2833068



**RETRO LOGO HOODIE**  
Gray | S-3XL | 2864630  
Navy | S-3XL | 2833060



**PURSUIT HOODIE**  
Orange | S-3XL | 2864606  
Black | S-3XL | 2833076  
Green | S-3XL | 2833077



**VENTURE HOODIE**  
Gray/Black | S-3XL | 2862491  
Navy/White | S-3XL | 2862492



**NEW**  
**ICON EDGE LONG SLEEVE**  
Blue | S-3XL | 2864683



**DASH LONG SLEEVE** ★ TOP SELLER  
Black/Red | S-3XL | 2833082  
Black | S-3XL | 2861582



BLACK  
BACK

**ADVENTURE LONG SLEEVE**  
Black | S-3XL | 2833090



BLACK  
BACK

**PERFORMANCE LONG SLEEVE**  
Black | S-3XL | 2862507



**ICON LONG SLEEVE**  
Lime | S-3XL | 2833083  
Black | S-3XL | 2861584

**MEN'S LIFESTYLE**



**NEW**  
**PEAK GRAPHIC TEE**  
 Black | S-3XL | 2864685



**NEW**  
**HALF DOME TEE**  
 Black | S-3XL | 2864616  
 Olive | S-3XL | 2864617



**NEW**  
**ASCENT TEE**  
 Olive | S-3XL | 2864680



**NEW**  
**SHIELD TEE**  
 Navy | S-3XL | 2864620



**NEW**  
**EAT. SLEEP. BRAP. TEE**  
 Heather Grey | S-3XL | 2864675  
 Black | S-3XL | 2864676



**ICON TEE** **TOP SELLER**  
**NEW** Navy | S-3XL | 2864596  
**NEW** Red | S-3XL | 2864595  
 Lime | S-3XL | 2833079  
 Green | S-3XL | 2862501  
 Black | S-3XL | 2861570



**SNOW 4 SCENE TEE**  
**NEW** Olive | S-3XL | 2864588  
 Gray/Red | S-3XL | 2861576  
 Blue | S-3XL | 2833512



**HERITAGE TEE**

**NEW** Heather Gray | S-3XL | 2864586  
Navy | S-3XL | 2860573



**EVOLUTION TEE** **TOP SELLER**

**NEW** Blue | S-3XL | 2864613  
Black | S-3XL | 2833088



**FLAG TEE** **TOP SELLER**

Navy | S-3XL | 2862500  
White | S-3XL | 2862582



**GRAPHIC TEE**

**NEW** Heather Gray | S-3XL | 2864612  
Dark Gray | S-3XL | 2833086  
Forest Green | S-3XL | 2833087



**MOUNTAIN TEE**

Gray | S-3XL | 2833084  
Blue | S-3XL | 2833085



**STAMP TEE** **TOP SELLER**

Navy | S-3XL | 2833078  
Green | S-3XL | 2861564  
Black | S-3XL | 2862496



**THINK OUTSIDE TEE**

**NEW** Blue | S-3XL | 2864634  
Green | S-3XL | 2833080  
Black | S-3XL | 2861567



**PIT SHIRT**

Black | XS-4XL | 2862526  
Navy | S-3XL | 2833043



**CORE POLO**

Black | S-3XL | 2861489  
Navy | S-3XL | 2861490

# HATS



### TONAL HAT

Black/Red | One Size | 2833497  
Navy | One Size | 2833496



### STAPLE CAP

 Cypress | One Size | 2864568  
Black | One Size | 2833127



### HIGHLAND CAP

 Red | One Size | 2864567  
Gray | One Size | 2833506



### LEATHER PATCH CAP

 Cypress | One Size | 2864569  
Black | One Size | 2833129  
Gray | One Size | 2833130



### JOURNEY CAP

 Light Blue | One Size | 2864570  
Black | One Size | 2833136  
Blue | One Size | 2833137



### ELLIPSE PATCH TRUCKER HAT

 Cypress | One Size | 2864562  
 Purple | One Size | 2864563  
Gray | One Size | 2833498  
Black | One Size | 2833500  
Navy | One Size | 2833499  
Orange | One Size | 2833124



### CORE CAP \* TOP SELLER

Red | One Size | 2833123  
Gray | One Size | 2833505  
Navy | One Size | 2833494  
Black | One Size | 2833495



### RETRO CAP \* TOP SELLER

Gray/Red | One Size | 2869542



### STEALTH CAMO CAP

Camo | One Size | 2861527



### HUNTER ORANGE HAT

Orange | S/M | 2860892  
Orange | L/XL | 2862545



**STAPLE BEANIE** ★ TOP SELLER

- Radiant Green | One Size | **2833121**
- Gray | One Size | **2833122**
- Black | One Size | **2833116**
- Navy | One Size | **2833117**



**SWITCHBACK BEANIE**

- NEW** Olive | One Size | **2864694**
- Blue | One Size | **2833115**
- Black | One Size | **2862532**
- Gray | One Size | **2862533**



**CORE BEANIE** ★ TOP SELLER

- NEW** Red | One Size | **2864695**
- NEW** Olive | One Size | **2864696**
- Blue | One Size | **2833114**
- Black | One Size | **2862530**
- Orange | One Size | **2862595**



# WOMEN'S RIDING GEAR

Our innovative designs and advanced technical materials keep you warm, dry, and happy – head to toe – on every ride. TECH54 jackets, bibs, and monosuits provide ultimate protection and comfort for every type of rider. And our helmets offer styles, designs, and features just right for the way you ride.



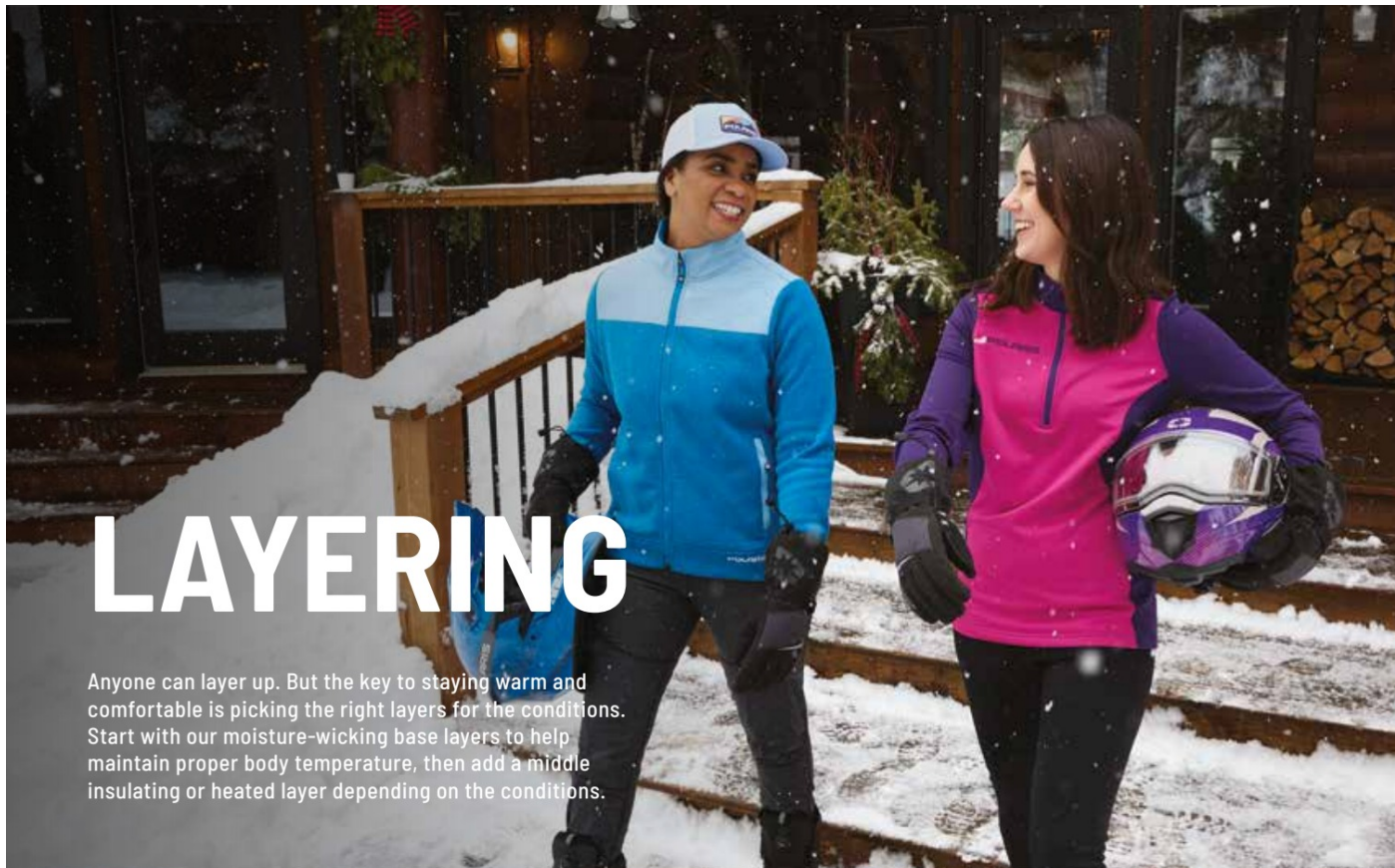

# LAYERING

Anyone can layer up. But the key to staying warm and comfortable is picking the right layers for the conditions. Start with our moisture-wicking base layers to help maintain proper body temperature, then add a middle insulating or heated layer depending on the conditions.



# LIFESTYLE

Polaris hats, tees and jackets show others how you choose to live your life. This is well-crafted clothing that's purpose-built to keep you comfortable outdoors—right where you want to be.



WOMEN'S CROSSOVER GEAR

**TECH54**



20K/20K



3M Thinsulate INSULATION

3M Scotchlite Reflective Material

YKK ZIPPERS

# BACKCOUNTRY MONOSUIT

PINK  
S-3XL  
2833020

ADVANCED INSULATED ONE-PIECE FOR WARMTH IN ANY RIDING CONDITION, ENABLES FREE RANGE OF MOTION AND PREVENTS SNOW INTRUSION TO KEEP YOU DRY AND COMFORTABLE

- Durable 300 denier poly shell is tear- and snag-resistant and treated with superior DWR to shed snow and water from the outer shell
- Features TECH54 bonded internal laminate with 20k/20k properties
- One-piece construction ensures powder stays on the outside
- Provides room for a mid-layer for added warmth against the cold
- Increased storage including four external pockets (two hand, one chest, one thigh)
- 140g 3M® Thinsulate® Insulation

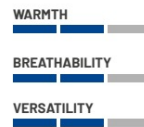

UNINSULATED



### IMPROVED MOBILITY

Action back for ease of movement and articulated fit for maximum mobility and comfort.



### CUSTOMIZED FIT

Adjustable waist tabs and internal suspenders for a comfortable and customized fit.



### SUPERIOR VENTING

Two vents on the side and two vents on the leg help heat as needed when riding, and the leg zips can be opened for extra venting when off the sled.



**NEW**  
**TEAL/GRAY**  
S-3XL  
2864511



**BLACK**  
S-3XL  
2833015



**NEW**  
**BLACK**  
S-3XL  
2864512

10K/10K

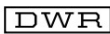

# SWITCHBACK

## JACKET

### QUICK-CHANGE VERSATILITY WITH DURABLE SHELL AND REMOVABLE ZONAL INSULATED LINER

- Durable 300 denier poly shell is tear- and snag-resistant and treated with superior DWR to shed snow and water from the outer shell
- Features TECH54 bonded internal laminate with 10k/10k properties
- Removable liner with 150g insulation in body and 100g in arms
- Shock-cord adjustable bottom hem to keep snow out
- Removable/adjustable hood
- Highly visible in low light conditions with 3M® Scotchlite® Reflective Material

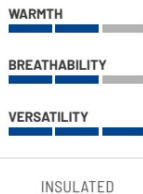

## BIB

### PREMIUM BIB FEATURES ZONAL INSULATION AND BREATHABLE WATERPROOFNESS

- Durable 300 denier poly shell is tear- and snag resistant and treated with superior DWR to shed snow and water from the outer shell
- Features TECH54 bonded internal laminate with 10k/10k properties
- Insulated with 120g insulation in front and 80g in back
- Two thigh vents
- Storm cuffs with boot lace retention snaps
- Highly visible in low light conditions with 3M® Scotchlite® Reflective Material

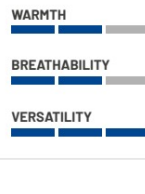

## WOMEN'S LAYERING

### WOMEN'S BASE LAYERS

Quick-drying and quick-wicking. Rests against your skin to regulate your overall body temperature by wicking away moisture.



**TOP**  
S-3XL | 2861455

**BOTTOM**  
S-3XL | 2861456

### MIDWEIGHT BASE LAYER

LIGHTWEIGHT, COMFORTABLE, MOISTURE-WICKING BASE LAYER

- Comfortable stretch fabric to allow for maximum movement
- 92% polyester, 8% spandex
- 220g fleece lined brushed fabric provides comfort and warmth

WARMTH



HEATING ELEMENT

**BLACK**  
S-3XL | 2833036

### HEATED VEST ★ TOP SELLER

COMFORT WITH THE TOUCH OF A BUTTON

- Perfect for any outdoor activity
- Down-proof machine washable material with 160g of insulation for warmth with or without the heater turned on
- Powered by a small rechargeable battery (included) that can be used to charge a cellphone; Battery not machine washable, remove prior to wash
- Easily adjust between 4 heat settings for changing weather conditions with built-in buttons



HEATING ELEMENT

**TOP**  
S-3XL | 2833033

**BOTTOM**  
S-3XL | 2833034

### HEATED BASE LAYER ★ TOP SELLER

ADJUSTABLE HEAT CLOSE TO YOUR BODY, MAXIMUM COMFORT IN CHANGING CONDITIONS

- Intended for use as a base layer
- Features lightweight, moisture-wicking fabric to give you the most comfortable layering to wear on all of your cold weather adventures, on or off the trail
- Includes multiple heat panels for evenly distributed heat for maximum warmth and comfort
- Powered by a small rechargeable battery (included) that can be used to charge a cellphone; Battery not machine washable, remove prior to washing
- Easily adjust between 4 heat settings for changing weather conditions with built-in buttons

WARMTH

ADJUST FROM LEVEL 1 TO 4 WARMTH WITH THE TOUCH OF A BUTTON

WOMEN'S MID-LAYERS

Insulating layers for the right level of warmth for your riding conditions.



**NEW**  
TEAL/LAGOON  
S-3XL | 2864528

TECH QUARTER-ZIP

FLEECE LINED MID-LAYER FOR ESSENTIAL WARMTH WHILE RIDING WITH THE STYLE AND COMFORT TO WEAR ANYWHERE

- Fleece-lining keeps you cozy and warm
- Move freely with four-way stretch material
- Moisture-wicking fabric keeps you warm and dry
- Contoured, slim fit



RADIANT GREEN  
S-3XL | 2833042

TITAN MID-LAYER

VERSATILE MID-LAYER CAN BE WORN ALONE OR AS AN EXTRA LAYER

- 319g Polartec® Thermal Pro® Rib Sweater provides great warmth
- Breathable material moves sweat to the outer surface
- Nylon overlay is comfortable and light



**NEW**  
PURPLE  
S-3XL | 2864529



RADIANT GREEN  
S-3XL | 2833038

SWITCHBACK MID-LAYER **TOP SELLER**

BATTLE THE COLD WITHOUT THE BULK AND SLIDE YOUR JACKET ON EASILY

- 280g of breathable fleece and a wear-resistant, sleek polyester face
- Inner spandex layer enhances fit without restricting movement
- Hand pockets perfect for mid-day stops when you remove your outer shell



BLACK  
S-3XL | 2862529

ADAPT QUARTER-ZIP **TOP SELLER**

EXTRA LIGHT MID-LAYER WITH A COMFORTABLE FIT

- Versatile use both on and off the trail
- A blend of polyester, cotton and rayon give this shirt a comfortable feel



**WOMEN'S LIFESTYLE**



**RADIANT GREEN**  
S-3XL | 2833040

**SOFTSHELL JACKET**

**VERSATILE LIGHTWEIGHT JACKET THAT'S PERFECT FOR EVERYDAY WEAR**

- Casual jacket armed with rugged and warm features for everyday wear
- Superior DWR prevents precipitation from saturating the jacket's exterior
- Lined with 280g of soft fleece for warmth
- Removable hood and underarm venting, three external pockets and one internal chest pocket



**BLACK**  
S-3XL | 2861433

**WOMEN'S FORCE PUFFER JACKET** TOP SELLER

**PACKABLE JACKET OFFERS LIGHTWEIGHT PROTECTION AND INCREDIBLE WARMTH**

- 140g 3M® Thinsulate®
- Two external hand pockets and one internal media pocket
- Rugged YKK® zippers
- Compactable into travel pocket



**TECH FULL-ZIP HOODIE**

TOP SELLER Fuchsia/Purple | S-3XL | 2864532  
Black | S-3XL | 2833097



**STAPLE HOODIE** TOP SELLER

TOP SELLER Deep Lagoon | S-3XL | 2864608  
Black | S-3XL | 2833095



**ICON HOODIE**

Gray | S-3XL | 2833099  
White | S-3XL | 2862512



**MOUNTAIN TEE**  
Pink | S-3XL | 2833106



**ADVENTURE TEE** \*TOP SELLER  
New Heather Gray | S-3XL | 2864604  
Pink | S-3XL | 2833104  
Teal | S-3XL | 2862629



**FLAG TEE** \*TOP SELLER  
White | S-3XL | 2833162



**ICON TEE**  
Black | S-3XL | 2862519



**JOURNEY CAP** \*TOP SELLER  
New Light Blue | One Size | 2864570  
Black | One Size | 2833136  
Blue | One Size | 2833137



**CORE TANK**  
Black | S-3XL | 2833161



**FAIR ISLE POM BEANIE** \*TOP SELLER  
White | One Size | 2864701



**REMOVABLE POM BEANIE** \*TOP SELLER  
Black | One Size | 2833119  
Green | One Size | 2861513  
Gray | One Size | 2861514



FOR THE NEXT GENERATION OF  
**OUTDOOR  
ENTHUSIASTS**



**YOUTH RIDING GEAR**

**TECH54**



**BLACK**  
S-XL  
2833045



**BLACK**  
S-XL  
2833049

**5k/5k**

**DWR**

**3M Thinsulate**  
INSULATION

**3M Scotchlite**  
Reflective Material

**YKK**  
ZIPPERS

# SWITCHBACK

## JACKET

- Durable 300 denier poly shell is tear- and snag-resistant and treated with superior DWR to shed snow and water from the outer shell
- Features TECH54 bonded internal laminate with 5k/5k properties
- 150g insulation in body and 100g in arms
- Shock-cord adjustable bottom hem keeps snow out
- Three external pockets (two hand, one chest)
- Highly visible in low light conditions with 3M<sup>®</sup> Scotchlite<sup>®</sup> Reflective Material

**WARMTH**

**BREATHABILITY**

**VERSATILITY**

INSULATED

## BIB

- Durable 300 denier poly shell is tear- and snag-resistant and treated with superior DWR to shed snow and water from the outer shell
- Features TECH54 bonded internal laminate with 5k/5k properties
- Insulated with 150g insulation in front and 100g in back
- Grow with Me Extension feature adjusts as your child grows taller
- Two external hand pockets
- Highly visible in low light conditions with 3M<sup>®</sup> Scotchlite<sup>®</sup> Reflective Material

**WARMTH**

**BREATHABILITY**

**VERSATILITY**

INSULATED

## NORTHSTAR GLOVE

- Mapped insulation with 200g on back of hand and 100g on palm
- Goggle squeegee on index finger and nose wipe on the back of thumb
- Gauntlet shock-cord closure to keep snow out



**BLACK**  
S-XL  
2861463

APPAREL

MENS APPAREL

WOMENS APPAREL

YOUTH APPAREL

HELMETS

GOGGLES

RIDERS SAFETY

GLOVES

BOOTS, BALACLAVAS, & LUGGAGE

HOME & COLLECTIBLES

## YOUTH HELMETS

BLACK  
S-L | 2862583



### YOUTH TACTICAL 2.0 HELMET

**FIDLOCK** FOR  
**POLARIS**

**FIDLOCK**

BUILT FROM THE GROUND UP WITH INNOVATIVE FEATURES FOR ULTIMATE COMFORT AND CONTROL

#### SHELL

- Shock-resistant, injection-molded thermoplastic

#### FEATURES

- Venturi Vent system generates negative pressure at velocity and pulls moist air from the breath box
- Integrated eyepoint seal is cointegrated with the breath box and creates a draft-free seal with 509 goggles for unparalleled warmth and clear field of view
- Magnetic Fidlock® chin-strap technology to enable faster securing and removing of the helmet
- DOT-and ECE 22.05-approved



**YOUTH LIFESTYLE**



**NEW**  
**YOUTH HERITAGE TEE**  
 Navy | S-XL | 2864629



**NEW**  
**YOUTH TECH FULL-ZIP HOODIE**  
 Fuchsia/Purple | S-XL | 2864533  
 Red | S-XL | 2833111



**NEW**  
**YOUTH ICON TEE**  
 Blue | S-XL | 2864599  
 Orange | S-XL | 2833169  
 Black | S-XL | 2862552



**YOUTH JOURNEY CAP**  
 Black | S-XL | 2833140  
 Navy | S-XL | 2833141



**NEW**  
**YOUTH SWITCHBACK BEANIE**  
 Purple | One Size | 2864712  
 Blue | One Size | 2862550  
 Gray | One Size | 2862551

**APPAREL**

MENS APPAREL

WOMENS APPAREL

YOUTH APPAREL

HELMETS

GOOGLES

RIDERS SAFETY

GLOVES

BOOTS, BALACLAVAS,  
 & LUGGAGE

HOME & COLLECTIBLES

HELMETS

# FUELING YOUR PASSION

Relentlessly driven by our passion for riding and the outdoors, 509 is the fuel that enables you to live your passion for adventure through innovative products and inspiring storytelling.

The lineup of 509 helmets for Polaris features innovative technology, next-level design, and the versatility to ride confidently in any terrain. Whether you're ascending deep mountain powder or enjoying a perfectly groomed trail, 509 for Polaris has a helmet to fit your riding passion.

**509** FOR  
**POLARIS**



**IGNITE**

## IGNITE DUAL-PANE CLIMATE CONTROL

Ride confidently knowing your vision will be fog-free and crystal clear as you maneuver through the trails.

SCAN THE QR CODE TO LEARN MORE ABOUT HOW TO POWER YOUR HEATED SHIELD.



# THE RIGHT HELMET FOR YOUR RIDE

Find the helmet that fits your riding style with the best combination of features at a price that's right for you.



## FULL FACE

- Full Face Protection
- Electric shield optional
- Easy to operate flip shield



**509 DELTA R3L**  
Unlimited versatility in dual-sport, full-face or open configurations with premium protection.

PREMIUM

## MOTO

- Full-helmet ventilation
- Removable breath box
- Enables preferred goggle & lens selection

### ULTIMATE



#### 509 ALTITUDE 2.0

Lightweight design, performance-infused style, and GOPRO® mounting capability

### PREMIUM



#### 509 TACTICAL 2.0

Combines style with versatility for ultimate comfort and control.

### BASE



#### TENACITY 4.0

Modern style, premium protection, incredible value.

## FIDLOCK

MAGNETIC TECHNOLOGY

The lineup of 509 helmets for Polaris features Fidlock® technology, an easy-on and easy-off magnetic closure device that delivers a quick, secure closure every time.



EASY ONE-HAND OPENING

EVEN WITH GLOVES

DOT- AND ECE-APPROVED



### MAKE ANY HELMET A SMART HELMET WITH THE CARDO PACKTALK EDGE

Connect with other riders with this Cardo Packtalk Edge Bluetooth® wireless mic. Attach it to the side of your helmet and put the speakers in your helmet to easily communicate with other riders on the go.



SCAN TO LEARN MORE

HELMETS



BLACK  
XS-2XL | 2861467

# VERSATILITY DELTA R3L

509 DELTA R3L HELMET



UNLIMITED VERSATILITY IN DUAL-SPORT, FULL-FACE OR OPEN CONFIGURATIONS WITH PREMIUM PROTECTION

**SHELL**

- Lightweight polycarbonate

**WEIGHT**

- 1,680g

**FEATURES**

- Dual-sport, full-face or open face configuration options
- Dual-pane anti-scratch, anti-fog coated ITO electric clear shield
- Comes standard with the Fidlock® easy-open magnetic strap buckle
- Drop-down internal sun shield in amber
- Push-button removable shield
- Removable cold-weather chin curtain
- Removable/washable liner and cheek pads
- DOT- and ECE 22.05-approved



MATTE BLACK  
XS-4XL | 2862468



PINK  
XS-4XL | 2833050

# TACTICAL

509 TACTICAL 2.0 HELMET



COMBINES STYLE WITH VERSATILITY FOR ULTIMATE COMFORT AND CONTROL

**SHELL**

- Shock-resistant, injection-molded thermoplastic

**WEIGHT**

- 1,300g

**FEATURES**

- Venturi Vent system generates negative pressure at velocity and pulls moist air from the breath box
- Integrated eyepoint seal is cointegrated with the breath box and creates a draft-free seal with 509 goggles for unparalleled warmth and clear field of view
- Magnetic Fidlock® chin-strap technology
- DOT- and ECE 22.05-approved



BLACK  
XS-4XL | 2861469

# ALTITUDE

## 509 ALTITUDE 2.0 HELMET



LIGHTWEIGHT DESIGN, PERFORMANCE-INFUSED STYLE, AND GOPRO® MOUNTING CAPABILITY

### SHELL

- Thermoplastic poly alloy outer shell

### WEIGHT

- Composite as low as 1,200g
- Carbon fiber as low as 1,150g

### FEATURES

- Strong, lightweight construction of carbon fiber or composite
- Superior fit for all-day comfort
- Integrated Pro Series breath box provides excellent ventilation and air flow
- One-piece eyeport creates draft-free seal with 509 goggles
- Magnetic Fidlock® chin-strap technology and integrated GOPRO® mount
- DOT- and ECE 22.05-approved



BLUE  
XS-2XL | 2833143



BLACK  
XS-2XL | 2861557



WHITE/RED  
XS-2XL | 2861561

# TENACITY

## TENACITY 4.0 HELMET

COMBINATION OF MODERN STYLE AND PREMIUM PROTECTION WITH INCREDIBLE VALUE

### SHELL

- Shock-resistant, injection-molded thermoplastic

### WEIGHT

- 1,500g

### FEATURES

- Through-flow, full-helmet ventilation
- ProClip quick release chin strap allows you to fasten the chin strap in seconds
- Removable breath box
- Toolless adjustable roost shield
- Removable, washable liner
- DOT- and ECE 22.06-approved

APPAREL

MENS APPAREL

WOMENS APPAREL

YOUTH APPAREL

HELMETS

GOGGLES

RIDER SAFETY

GLOVES

BOOTS, BALACLAVAS,  
& LUGGAGE

HOME & COLLECTIBLES

## GOGGLES

**STEALTH**  
2833155



CLEAR SMOKE

**BLACK/RED**  
2833157



MIRRORED FIRE ROSE

**RETRO**  
2833156



CLEAR SMOKE



## CARRY MULTIPLE LENSES SO YOU CAN EASILY ADJUST FOR LIGHTING FROM DAWN TO DUSK



### MIRRORED

- Reduces glare by reflecting light
- Maintains visibility of LCD readouts
- Paired with lighter tints to offset darkening



### BLUE

Reduces eyestrain



### YELLOW

Enhances flat-light terrain definition



### CLEAR

Increases contrast in cloudy conditions



### SMOKE

Cuts down brightness without color distortion



### ROSE

Delivers superior low-light visibility



### POLARIZED

- Substantially reduces glare & blinding
- Blocks horizontal light waves
- Decreases eyestrain

# X7

## 509 SINISTER X7 SNOW GOGGLE

**FOR**  
**POLARIS**

FEATURING EXCELLENT VISIBILITY, ANTI-FOG PERFORMANCE AND DURABILITY



**QUICK CHANGE 5MAG MAGNETIC LENS TECHNOLOGY**

SWAP OUT LENSES WITH EASE

### SINISTER X7 LENSES



YELLOW

2833172



CLEAR

2833173

- 5MAG lens retention system is a magnetic lens technology for quick and easy lens changing on the go
- Soft goggle frame for unparalleled comfort and fit
- Hard lens frame insures an optimal fit and a great seal
- Over the glasses compatible
- Shuttered venting in frame scoop air in or closes off flow
- Easily replace lens for varying conditions
- Improved tints, low light, and contrast improving technologies including polarized, HCS, and photochromatic also available



RADIANT GREEN  
2833055



LIGHT ROSE HCS TINT

BLACK/GRAY  
2861476



SMOKE

BLACK/RED  
2861477



FIRE MIRROR LIGHT ROSE

RETRO  
2862555



CLEAR



# KINGPIN

## KINGPIN 509 SNOW GOGGLE



PREMIUM MATERIALS IN AN AFFORDABLE PACKAGE

- Oversized spherical lens delivers optimal peripheral vision
- Maximum anti-fog and scratch-resistant
- Contoured frame and triple-layer foam seals out cold and snow
- Removable nose piece delivers versatile cold-weather protection
- Quick-change lens technology for fast lens-tint swaps



QUICK-CHANGE LENS TECHNOLOGY  
SWAP OUT LENSES WITH EASE

### KINGPIN LENSES



CLEAR	2868547
YELLOW	2868548

FIND THE PERFECT LENS FOR EVERY LIGHT CONDITION AT [POLARIS.COM/SNOWGOGGLES](http://POLARIS.COM/SNOWGOGGLES)

# RIDE SAFELY

## TODAY SO YOU CAN RIDE SAFELY TOMORROW.



Polaris is proud to partner with PIEPS®, the world's foremost authority in snowmobile avalanche safety equipment. Designed with riders in mind, PIEPS® has over 45 years of experience in developing and testing the absolute best in avalanche airbag, beacon, probe and related safety technologies. Ride with confidence knowing you have state-of-the-art equipment and the skills to face a backcountry emergency.



### PIEPS® JETFORCE BT

#### ADVANCED LIGHTWEIGHT PERFORMANCE LOADED WITH TECHNOLOGY

Smartphone updates and Bluetooth® connectivity, automatic airbag deflation and modular booster system adapt to your riding needs.

- Digital, lithium-ion-powered turbine fan system allows for practice deployments at home
- Quickly and conveniently recharge with micro-USB
- Integrated self-diagnostic lights inform when pack is ready or requires charging
- Deployment handle can be located on the left or right for rider-preference control
- Available in 10L, 25L and 35L capacities for riding essentials
- Adjustable hip belt and leg loop ensure packs stay secure while riding

#### JETFORCE BT EXCLUSIVE EXTRAS

- Automatic deflation sequence creates an air pocket under the snow
- Update software with Bluetooth® connectivity and PIEPS® App
- Customize pack's capacity with interchangeable booster in 10L, 25L or 35L, sold separately



Easy access safety pocket for shovel blade, handle and probe





	JETFORCE BT 10	JETFORCE BT 25	JETFORCE BT 35
<b>PACK CAPACITY</b>	10L	25L	35L
<b>WEIGHT</b>	6.3lbs / 2.84kg	6.6lbs / 2.98kg	6.7lbs / 3.04kg
<b>AIRBAG VOLUME</b>	170L	170L	170L
<b>BLACK</b>	2883672	2883673	2884311



**INTERCHANGEABLE  
BOOSTER:  
CUSTOMIZE YOUR PACK  
CAPACITY AND COLOR**



	JETFORCE BT 10	JETFORCE BT 25	JETFORCE BT 35
<b>CHILI RED</b>	2884313	2884316	2884319
<b>SKY BLUE</b>	2884314	2884317	2884320
<b>BLACK</b>	2884315	2884318	2884321



**PIEPS® JETFORCE SC** ★ TOP SELLER

**BEST-SELLING PERFORMANCE WITH SUPERCAPACITOR SYSTEM**

Featuring Alpride E1 supercapacitor airbag technology. Cartridge-free system is compact, easy to use and charges in under 60 minutes—even while riding.

- Supercapacitor powered fan system allows for convenient practice deployments
- Quickly and conveniently recharge with micro-USB or AA batteries
- Self-diagnostic lights inform when pack is ready or requires charging
- Deployment handle can be located on the left or right for rider-preference control
- Easy-access safety pocket for shovel blade, handle and probe
- Convenient 20L internal compartment holds riding essentials
- Adjustable hip belt and leg loop ensure packs stay secure while riding

<b>VOLUME</b>	20L
<b>WEIGHT</b>	5.7lbs / 2.60kg
<b>AIRBAG VOLUME</b>	150L
<b>BLACK</b>	2883674



**PIEPS® POWDER BT**

High-performance circular receiving range, 300-hour battery life and PIEPS® App connectivity.

<b>MAXIMUM RANGE</b>	60m
<b>SEARCH STRIP WIDTH</b>	60m
<b>WEIGHT</b>	220g (including batteries)
<b>BATTERY LIFETIME</b>	Min. 300 h SEND-mode with Lithium batteries Min. 200 h SEND-mode with Alkaline batteries
<b>POWER SUPPLY</b>	3x Alkaline (AAA) / 3x Lithium (AAA)
<b>DIMENSIONS (LxWxH)</b>	118 x 76 x 29mm
	<b>2883676</b>



**PIEPS® PRO BT**

Optimum circular receiving range, 600-hour battery life and PIEPS® App connectivity designed for all mountain pros.

<b>MAXIMUM RANGE</b>	60m
<b>SEARCH STRIP WIDTH</b>	60m
<b>WEIGHT</b>	230g (including batteries)
<b>BATTERY LIFETIME</b>	Min. 600 h SEND-mode with Lithium batteries Min. 400h SEND-mode with Alkaline batteries
<b>POWER SUPPLY</b>	3x Alkaline (AAA) / 3x Lithium (AAA)
<b>DIMENSIONS (LxWxH)</b>	118 x 76 x 29mm
	<b>2884161</b>



### PIEPS® IPROBE BT

Optical and acoustic signal indicates an electronic "hit" within a 1m diameter to eliminate near misses and false strikes when probing, saving valuable time during a rescue.

TUBES	6
TUBE DIAMETER	12.5mm
LENGTH	260cm
WEIGHT	430g
	2884969



### PIEPS® SHOVEL T 825 PRO+ WITH SAW BLADE

The PIEPS® SHOVEL T825 Pro+ with integrated snow saw and extra-large blade is perfect for snow layering analysis and bivouac building.

BLADE DIMENSIONS	30.5 x 24cm 4 x 4.5cm
TOTAL WEIGHT	825g
HANDLE LENGTH	80cm
	2883680



### PIEPS® CARBON TOUR 260 PROBE

Weight: 270g | 2884312



### PIEPS® ALUMINUM 260 PROBE

Weight: 300g | 2883678



FOR ADDITIONAL AVALANCHE SAFETY PRODUCT INFORMATION VISIT  
[POLARIS.COM/SNOWSAFETY](http://POLARIS.COM/SNOWSAFETY)



**MEN'S**  
S-3XL | 2862480



# TITAN

## LEATHER GLOVE

- Durable glove with reinforced leather on palm for long-lasting wear and excellent control and feel
- 300g 3M® Thinsulate® Insulation on back of hand and 100g 3M® Thinsulate® Insulation on palm
- 3M® Scotchlite® Reflective Material for added safety in all weather conditions
- Built-in goggle wipe

INSULATION	=====
PADDING	=====
GRIP	=====



# NORTHSTAR

## GLOVE

- Premium performance with rugged polyester and leather construction
- Reinforced leather palm provides excellent control and feel
- Men's zonal warmth of 250g of 3M® Thinsulate® on backside and 150g in palm
- Women's zonal warmth of 300g of 3M® Thinsulate® on backside and 150g in palm

INSULATION	=====
PADDING	=====
GRIP	=====



**WOMEN'S**  
S-3XL | 2861462

**MEN'S**  
S-3XL | 2861461



**MEN'S**  
S-3XL | 2861460



# SWITCHBACK

## GLOVE

- Reinforced leather palm for excellent control and feel
- Integrated goggle wipe effectively clears snow, moisture and ice
- Removable fleece liner and 150g of 3M® Thinsulate® add versatility and warmth
- Touch-screen compatible

INSULATION



PADDING



GRIP



# REVELSTOKE

## GLOVE

- Reinforced leather palm for excellent control and feel
- Adjustable wrist strap seals out snow
- Dry-zone anti-slip insert
- 150g of 3M® Thinsulate® on back of hand
- Built-in goggle squeegee on backside of glove to keep vision clear
- Touchscreen compatible

INSULATION



PADDING



GRIP



**MEN'S**  
S-3XL | 2861459

## BOOTS & BALACLAVAS

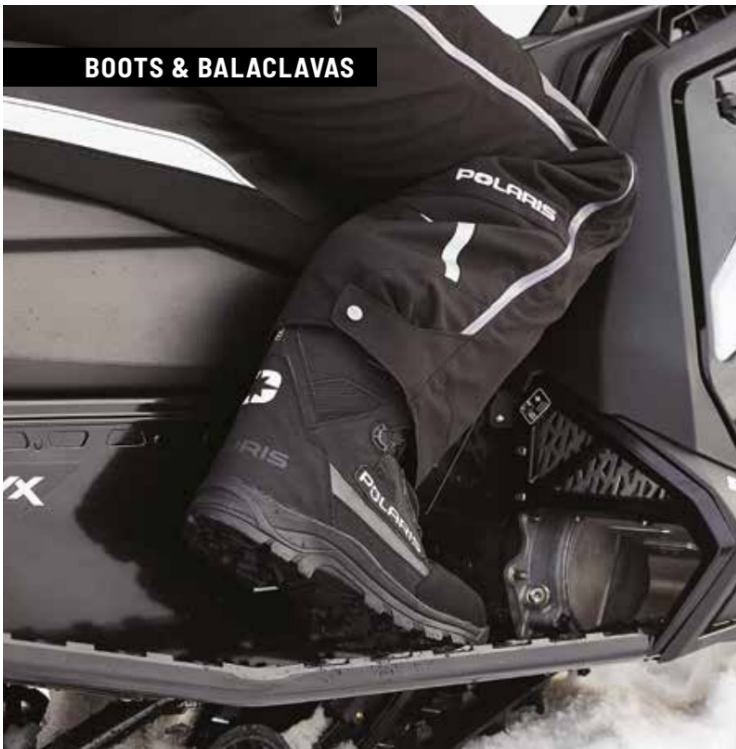

ICE LOCK® SOLE TECHNOLOGY



800G OF 3M® THINSULATE® INSULATION

### BOA® LACING SYSTEM VS. LACES

Push to engage. Turn to tighten. Pull for quick release. The BOA® lacing system is easier to get on and off than traditional lace-up boots and gives a perfect fit with the turn of a knob. Even with gloves on.



## SWITCHBACK 2.0 BOOT

### PERFORMANCE, WARMTH AND COMFORT

- Waterproof and breathable TECH54 membrane keeps moisture out and allows perspiration to escape to keep your feet dry and comfortable
- 800g 3M® Thinsulate® Insulation helps provide warmth in cold weather
- Durable leather material
- BOA® lacing system
- Hypergrip outsole with Icelock provides better traction on wet and slippery surfaces

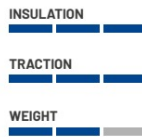

BLACK

Sizes: 5-14 | 2862481



### MOUNTAIN BALACLAVA

- Laser-cut breath holes
- Windproof four-way stretch material blocks wind in key areas while providing extreme comfort

One Size | 2861474



### TRAIL BALACLAVA

- Anti-fog neoprene nose guard
- Heavier windproof four-way stretch material blocks wind in key areas while providing extreme comfort

One Size | 2861475





**9800 RIG ROLLER**

- SLED (Structural Load Equalizing Deck) system for increased durability and handling in the harshest of conditions
- Large main compartment with adjustable dividers and padded helmet chamber
- iFOM (integrated foam) construction throughout for added gear protection
- Heavy-duty oversized wheels with extra clearance
- Telescoping pull handle
- Dimensions: 32" H x 16.5" W x 15.25" D

2861483



**CARRY-ON BAG**

- Custom in-line skate wheels and locking retractable handles provide optimum mobility
- 2-stage Pullman handle
- Internal compression straps
- Airline regulation carry-on size with 3" expansion zipper
- Dimensions: 22" H x 14" W x 10" D

2861486



**DUFFLE BAG**

- Front zippered pocket
- Fabric-wrapped handle and padded shoulder strap
- Ventilated shoe compartment with grab handle
- Dimensions: 24" H x 12" W x 9" D

2861607



**EXPLORER BACKPACK**

- Easy-to-reach essential gear compartments and pockets
- Sewn-in EVA molded compartment that protects your fragile and valuable items
- Luggage handle pass-through for easy transport and mobility
- Dimensions: 19.5" H x 14" W x 1.5" D

2861485



**SPOKE BAG**

- Large main compartment with roll-out changing mat
- Lightweight for greater carrying capacity
- Two-stage trolley handle and reinforced replaceable wheel set
- Dimensions: 32" H x 16.5" W x 16" D

2861487





**LEATHER LOOP KEYCHAIN**  
2861615



**KEYCHAIN**  
★ TOP SELLER  
2861614



**FLASK**  
2860812



**PREMIUM KOOZIE**  
★ TOP SELLER  
2860829



**KICKBACK ROCKER**  
★ TOP SELLER  
2862626



**FREESTYLE ROCKER**  
★ TOP SELLER  
2862625



**EASY CHAIR**  
★ TOP SELLER  
2862627



**QUICK-E-SEAT**  
★ TOP SELLER  
2862624



**NEW**  
**POLARIS RACING MUG**  
2864716



**12oz CAMPER MUG**  
2861612



**23oz WATER BOTTLE**  
2862685



**HITCH COVER**  
2861623



**WOOD SIGN**  
10.5" x 24" | 2860866



**POLARIS PARKING SIGN**  
2869934



**POLARIS FLAG**  
3' x 5' | 2869928



**DECK OF CARDS**  
2860816

**POLARIS**  
**ENGINEERED**

# ACCESSORIES

## YOUR ULTIMATE RIDE.

Make the best even better. Designed, engineered and tested to the same demanding standards as our snowmobiles, Polaris Engineered accessories perfectly complement how you ride. This means they fit perfectly, mount effortlessly, and perform to the highest standards in the backcountry, on the trail and everywhere in between.

### ACCESSORY CONTENTS

64	Lock & Ride Flex	102	PRO-RIDE
66	Covers	108	Ride Readiness
68	Polaris Partners	120	Color Customization
70	Connected Technology	112	Transport
72	MATRYX	114	Traction & Control
86	AXYS	116	Tracks



SCAN TO VISIT THE  
ACCESSORY INSTALL  
INSTRUCTION PORTAL



# RIDER ACCESSORY COLLECTIONS

## EXPLORE THE POSSIBILITIES

Customization has never been easier. Start with our Rider Accessory Collections, designed for you. These collections include the best and most popular accessories to elevate your riding experience for the way you ride. Explore the possibilities and take your vehicle to the next level.



## MOUNTAIN

2889259	Burandt Bag - Large	P. 75	2884979	Grill Inserts	P. 84
2882823	Goggle Handlebar Bag	P. 76	2884817	Sentry Front Bumper	P. 85
2889322	Spare Shovel Jacket	P. 77	2889353	Sentry Mountain Rear Bumper	P. 85
2884816	Sentry Skid Plate	P. 84			



SCAN TO  
LEARN MORE



## CROSSOVER

2889258	Burandt Bag - Medium	P. 75
2889733	Auxiliary Flood Light	P. 78
2884937	Heated Driver Seat	P. 80
2890103	Insight Side Mirrors	P. 80
2884616	Defend Handguards	P. 83
2884617	Defend Handguard Mounts	P. 83

2884933	Defend Handguard Signature Light	P. 83
2884816	Sentry Skid Plate	P. 84
2884817	Sentry Front Bumper	P. 85
2884257	Sentry Trail Rear Bumper	P. 85
2889142	Magnetic Tether	P. 108



**SCAN TO  
LEARN MORE**



## TRAIL

2884456	Lock & Ride Flex Adventure Tunnel Bag - Tall	P. 74
2889776	Dash Storage Bag	P. 76
2889863	Auxiliary Punch Light	P. 78
2890103	Insight Side Mirrors	P. 80

2884937	Heated Driver Seat	P. 80
2889255	Adjustable Windshield	P. 82
2884979	Grill Inserts	P. 84
2884817	Sentry Front Bumper	P. 85



**SCAN TO  
LEARN MORE**



## CUSTOMIZE YOUR CONFIGURATION FOR THE WAY YOU RIDE.

Lock & Ride Flex enables multiple configurations to easily add storage and passenger seating to your snowmobile in one simple click. Explore how you can make it your own with Lock & Ride Flex.



RETROFIT YOUR SLED WITH



### LOCK & RIDE FLEX ADAPTER KIT

AXYS PRO-RIDE

• Add Lock & Ride Flex storage to AXYS and Pro-Ride full tunnel sleds

2884939 **★ TOP SELLER**

ALL PRO-RIDE & AXYS SLEDS W/ TUNNEL T-SLOTS,  
NOT COMPATIBLE WITH LOCK & RIDE FLEX M2 SEAT



# EASY & SECURE

Customize Your Lock & Ride Flex Configuration for your Tunnel Length.

- Push to secure
- Lift to release
- No turning, no twisting

- Customizable configurations
- Retro-fit compatible

## 121" TUNNEL AND LONGER

SPORT TUNNEL BAG - TALL



1 SMALL

## 128" - 146" TUNNEL AND LONGER

ADVENTURE TUNNEL BAG - TALL



1 MEDIUM  
OR  
2 SMALL

## 155" TUNNEL AND LONGER

BURANDT BAG - LARGE



1 LARGE  
OR  
1 MEDIUM + 1 SMALL  
OR  
3 SMALL

## SMALL



- 2884453 Sport Tunnel Bag - Low
- 2884454 Sport Tunnel Bag - Tall
- 2884957 M2 Seat - Heated
- 2884725 M2 Seat - Standard
- 2890008 Waterproof Roll-Top Bag
- 2890496 Trail Jump Seat

## MEDIUM



- 2884455 Adventure Tunnel Bag - Low\*
- 2884456 Adventure Tunnel Bag - Tall\*
- 2889258 Burandt Bag - Medium\*
- 2889228 M2 Journey Bag
- 2890599 Adventure Rack Bag
- 2890018 Adventure Rack\*\*

## LARGE



- 2889259 Burandt Bag - Large\*



\*Additional color options available.  
\*\* 136" tunnel and longer.

LEARN MORE AT  
[POLARIS.COM/LOCKRIDEFLEX](http://POLARIS.COM/LOCKRIDEFLEX)



## PROTECT YOUR SLED FROM THE ELEMENTS

### KEEP YOUR SLED LOOKING NEW WITH A POLARIS COVER

- Keep snow and ice off of your sled in between days of riding
- Protect your sled from dirt and slush while trailering
- Protect from harmful UV rays that could fade your coloring over time
- Choose between premium polyester for maximum protection and trailering or the overnight cover for in between rides

## THE POLARIS ADVANTAGE WHY SHOULD YOU CHOOSE A POLARIS COVER?

- 1. INTENTIONALLY DESIGNED** for your sled and features easy to use cinch strap technology for a secure hold and perfect fit
- 2. PREMIUM MATERIALS** provide advanced protection and lasting durability through the elements
- 3. RIDER-CENTRIC FEATURES** such as integrated zippers and straps make Polaris covers easy to use with quick access



### OVERNIGHT/DUST COVER

Lightweight and packable. Ideal for overnight multi-day drops or parking in a shop.



### 3/4 COVER

This cover is ideal for overnight protection, when the sled is stored between rides and during trailering. Designed to fit over all windshield styles and all accessories. Does not cover the tunnel so you still have access to storage & racks.



### FULL COVER

Full sled protection with perfect fitment for your model. Great for towing and off season storage. Zipper access to gas cap, and quick adjust cinch straps and hooks for tightening.

## MATRYX COVERS



**NEW**  
**MATRYX RMK PREMIUM  
POLYESTER 3/4 COVER** MATRYX

- 3/4 design is very easy to put on and take off and works great providing quick access to accessories on the tunnel

2890590  
ALL MATRYX RMK



**NEW**  
**MATRYX TRAIL PREMIUM  
POLYESTER 3/4 COVER** MATRYX

- 3/4 design is very easy to put on and take off and works great providing quick access to accessories on the tunnel

2890591  
ALL MATRYX INDY, SWITCHBACK & VOYAGEUR



**MATRYX RMK PREMIUM  
POLYESTER FULL COVER** MATRYX

- Reinforced material added in high impact areas
- New rear strapping system that is much easier to put on and reduces buffeting when trailering
- Improved windshield strap that results in a tighter fit

Full | **2889348** ★ TOP SELLER  
ALL MATRYX RMK



RETRO  
**MATRYX TRAIL PREMIUM  
POLYESTER FULL  
CONVERTIBLE COVER** MATRYX

- MATRYX redesigned cinch straps are easier to use and hold secure for a premium fit
- Advanced polyester blend for increased protection
- Convertible Cover: expands and adapts to fit various MATRYX accessory configurations
- Features an integrated rear zipper to accommodate for accessories including seats

Black | **2890074** ★ TOP SELLER  
Retro | **2889914**

ALL MATRYX INDY, SWITCHBACK & VOYAGEUR



**MATRYX  
OVERNIGHT COVER** MATRYX

- Protects sled from the elements when stored outside overnight
- Made of lightweight polyester that is easy to fold and store
- Ideal for overnight multi-day trips or parked in a shop

**2884749**  
ALL MATRYX

## AXYS & PRO-RIDE COVERS

### PREMIUM POLYESTER

- Lightweight, custom fit and extreme protection for the ultimate trailering cover
- Premium UV-resistant and water-repellent capability, great for extended outdoor storage
- Adapts to a full range of windshield heights and secures with integrated straps
- Full Convertible Covers: Cover expands and adapts to fit various accessory configurations

All AXYS Full Tunnel 129, 137, 144 & 146	Full Convertible	<b>2883568</b>
All TITAN	Full Convertible	<b>2882800</b>
PRO-RMK/SKS	¾	<b>2881042</b>
RMK ASSAULT	¾	
RUSH	¾	
SWITCHBACK	¾	<b>2880431</b>
SWITCHBACK ADVENTURE	¾	
RUSH	Full	<b>2882223</b>
SWITCHBACK	Full	<b>2882224</b>
SWITCHBACK with Rack/ADVENTURE	Full	<b>2882225</b>
SWITCHBACK 144	Full	<b>2882133</b>
PRO-RMK 155 / SKS 146/155	Full	
RMK ASSAULT 163/174	Full	<b>2882134</b>

### CANVAS

- Coated, heavy-gauge canvas remains flexible in extreme cold temperatures
- Adjusts to a full range of windshield heights and secures with integrated straps
- Water-repellent, UV-resistant and versatile for trailering or storage

RUSH/SWITCHBACK with Sport Rack	Full	<b>2882136</b>
RUSH	Full	<b>2882135</b>
SWITCHBACK 137	Full	<b>2882137</b>
SWITCHBACK ADVENTURE with Rack	Full	<b>2882138</b>
SWITCHBACK ASSAULT 144	Full	<b>2881969</b>
PRO-RMK 155 / SKS 146/155	Full	
RMK 163/174	Full	<b>2881980</b>
INDY 121/INDY EVO	Full	<b>2878725</b>
550 INDY 144	Full	<b>2879845</b>
INDY VOYAGEUR 144	Full	
INDY LXT	Full	<b>2880515</b>
INDY VOYAGEUR 144/155 with 2-Up Seat	Full	
INDY VOYAGEUR 155	Full	<b>2880516</b>
All Pro-Ride 144/155	Full	<b>2879844</b>

### UNDERCOVER AXYS

- Made to go under Polaris snow covers to provide an additional level of protection
- Easy to install and remove

**2881981**  
ALL AXYS



### INDY 120 COVER

- Cover option for youth sled
- Perfect for overnight or trailering

**2889890**  
ALL 120 SNOWMOBILES



**DESIGNED** by the people who designed your vehicle.

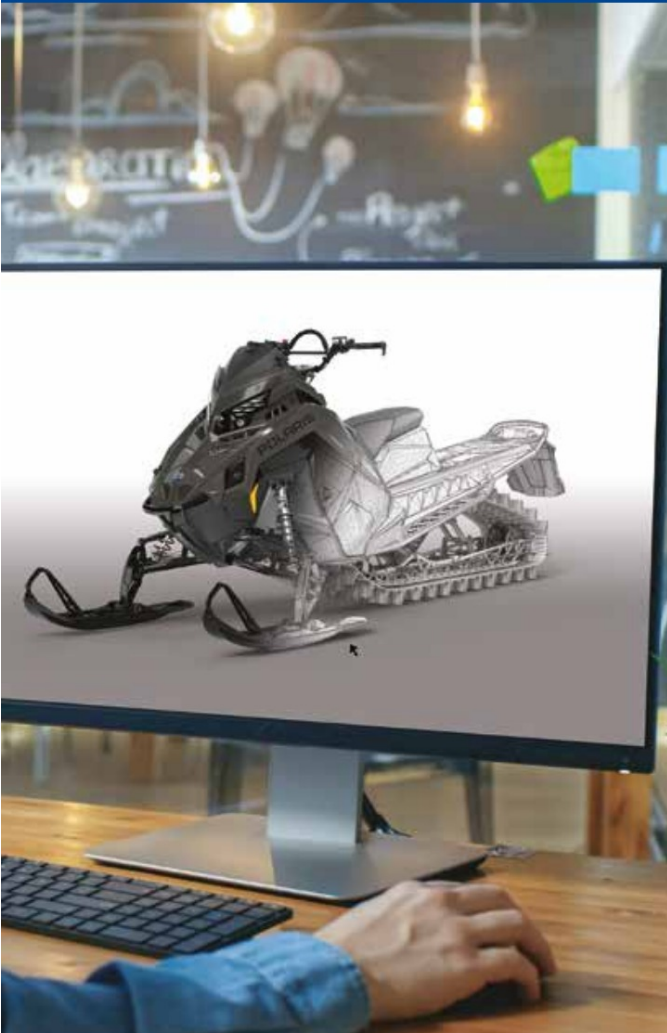

**TESTED** extensively in the field so you ride with 100% confidence.



**WE HOLD OUR PARTNERS  
TO THE SAME STANDARDS**



Highly functional tools and tool kits for powersports

P. 109



Industry leader in High performance Shocks

P. 110

# KEEP YOUR STANDARDS HIGH. WE DO.

ACCESSORIES

**TRUSTED** 65+ years in the business.  
The Original Snowmobile Company.

ACCESSORIES  
BACKED BY A



WARRANTY



LOCK & RIDE  
FLEX

COVERS

POLARIS  
PARTNERS

CONNECTED  
TECHNOLOGY

MATRIX

AXIS

PRO-RIDE

RIDE  
READINESS

COLOR  
CUSTOMIZATION

TRANSPORT

TRACTION  
& CONTROL

TRACKS



High performance pull  
start cords – guaranteed  
to last a lifetime

P. 111



Fully customize  
your trailer

P. 112



Premium studs and  
carbides exclusively  
engineered for Polaris

P. 114



High performance tracks

P. 116

# POLARIS RIDECOMMAND ENHANCE YOUR RIDE

Designed with integrated RIDE COMMAND technology exclusively for the MATRYX platform, the 7S Display brings a whole new level of intuitive, touch-screen control and customization with our largest and most sophisticated display yet.

LEARN MORE AT  
[SNOWMOBILES.POLARIS.COM/RIDECOMMAND](http://SNOWMOBILES.POLARIS.COM/RIDECOMMAND)



### 7-INCH GLOVE TOUCH COMPATIBLE DISPLAY

Easy control in cold weather.  
Dedicated day and night mode.  
Display adjusts automatically based on ambient light levels.



### TRACK AND COMMUNICATE WITH YOUR RIDE GROUP

Industry leading vehicle to vehicle Group Ride allows you to see and follow your group - whether you have cellular data connectivity or not.  
Auto-records every ride to the display with 64gb of onboard storage, and is fully transferable via USB.  
Send your buddies a Help Alert message to let them know you need assistance while out riding. Group Riders in an active help alert status will also have a blinking red triangle as their icon on the map.



### PLAN & NAVIGATE WITH ONBOARD POINTS OF INTEREST

Create and plan your route using complementary RIDE COMMAND mobile app and website.  
View a full set of gas, food, and lodging information all on the industry's leading trail data set.  
Map, trail, and POI data encompasses the entire North American snow belt.  
Seamlessly sync your planned routes, rides, and waypoints to and from your RIDE COMMAND account.



### 7S DISPLAY POWERED BY RIDE COMMAND **MATRYX**

- Create and plan your route with on-board maps and trails
- Full set of gas, food, and lodging information available on or off line
- Group Ride feature keeps all riders in sight even when you split up
- Live trail conditions is only available via RIDE COMMAND app on mobile device

2884971

ALL MATRYX. REQUIRES INSTALL KIT (2884972). SOLD SEPARATELY

### 7S DISPLAY INSTALL KIT **MATRYX**

- Required for 7S Display installation

2884972  
ALL MATRYX



SCAN THE QR CODE TO DOWNLOAD THE RIDE COMMAND APP FOR FREE





ACCESSORIES

LOCK & RIDE  
FLEX

COVERS

POLARIS  
PARTNERS

CONNECTED  
TECHNOLOGY

MATRIX

AXYS

PRO-RIDE

RIDE  
READINESS

COLOR  
CUSTOMIZATION

TRANSPORT

TRACTION  
& CONTROL

TRACKS



# MATRYX

The rider-first MATRYX platform delivers instinctive, intuitive control with breakthrough rider dynamics and such seamless accessory integration that rider and machine become one. These accessories look, feel and function like integral elements of the sled.

## RMK

MY23-24 SKS 146  
MY22-24 PRO RMK SLASH 155/165  
MY22-24 RMK KHAOS SLASH 146/155/165  
MY22-23 RMK KHAOS SLASH 163  
MY22-24 PRO RMK 155  
MY22-24 RMK KHAOS 155  
MY22-23 PRO RMK SLASH 163

## SWITCHBACK

MY23-24 SP 146  
MY22-24 XC 146  
MY21-24 ASSAULT 146

## VOYAGEUR

MY22-24 146

## INDY

MY23-24 INDY SP 137  
MY22-24 XCR 128/136  
MY22-24 ADVENTURE 137  
MY22-24 XC 129/137  
MY21-24 VR1 137  
MY22-23 ADVENTURE X2 137  
MY21-23 VR1 129  
MY21 XC LAUNCH EDITION 129/137



# BUILD YOUR OWN POLARIS TRAILER



VISIT OUR WEBSITE

TRADE IN TRAILERS



2  
PAC

## RATCHET STRAP 2000KG

- Keep your Snowmobile, ATV or Ranger safely strapped at your trailer.
- Dimension 3,5cm/ 50cm/ 550cm
- Max load 2000kg/ working load 1000kg
- 2 pac

POL05031

## MATRIX - PERFORMANCE

### NEW REVERSIBLE ICE SCRATCHERS MATRIX AXYS

- Maintains optimum track and engine temperature in a wider variety of snow conditions delivering an enhanced riding experience
- Single coil design for increased durability on the trail
- Fully reversible scratchers for added durability and convenience

2890644

2011-2024 RMK MODELS  
STANDARD ON MY24 RMK MODELS

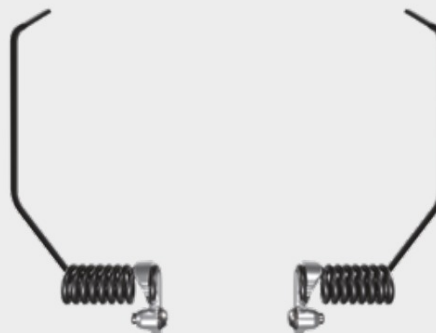

ACCESSORIES

LOCK & HIDE  
FLEX

COVERS

POLARIS  
PARTNERS

CONNECTED  
TECHNOLOGY

MATRIX

AXYS

PRO-RIDE

RISE  
READINESS

COLOR  
CUSTOMIZATION

TRANSPORT

TRACTION  
& CONTROL

TRACKS

73

# MATRYX - STORAGE



LOW  
**10**  
LITERS

TALL

**15**  
LITERS



## SPORT TUNNEL BAG

MATRYX AXYS PRO-RIDE



- Semi-rigid design available in two profiles; fits great with M2 seat
- Oversized buckles provide easy access to gear with your gloves on
- Keep your items organized and secure inside with Velcro® adjustable dividers

- Base is water-resistant to keep your gear dry
- Installation on AXYS and Pro-Ride sleds requires the Lock & Ride Flex Adapter Kit (2884939), sold separately

Low | **2884453**

ALL MATRYX, ALL AXYS & PRO-RIDE 121 AND LONGER WITH FULL TUNNEL AND LOCK & RIDE FLEX ADAPTER KIT

Liner Bag - Small | **2889260**

Tall | **2884454**

ALL MATRYX, ALL AXYS & PRO-RIDE 121 AND LONGER WITH FULL TUNNEL AND LOCK & RIDE FLEX ADAPTER KIT

Liner Bag - Large | **2889261**



**10-15**  
LITERS



## WATERPROOF ROLL TOP BAG

MATRYX AXYS PRO-RIDE



- Our highest level of moisture resistance, built to protect your valuables
- Roll top design allows for quick and easy access

**2890008**

ALL MATRYX, ALL AXYS & PRO-RIDE 121 AND LONGER WITH FULL TUNNEL AND LOCK & RIDE FLEX ADAPTER KIT



**23**  
LITERS

LOW

TALL

**35**  
LITERS



## ADVENTURE TUNNEL BAG

MATRYX AXYS PRO-RIDE



- Semi-rigid design available in two profiles
- Oversized buckles provide easy access to gear with your gloves on
- Keep your items organized and secure inside with Velcro® adjustable dividers

- Base is water-resistant to keep your gear dry
- Installation on AXYS and Pro-Ride sleds requires the Lock & Ride Flex Adapter Kit (2884939), sold separately

LOW

Black | **2884455**

Liner Bag - Small | **2889262**

### CARBON FIBER COLOR OPTIONS

- Sky Blue **2890622**
- Neon **2890623**

ALL MATRYX, ALL AXYS & PRO-RIDE 128 AND LONGER WITH FULL TUNNEL AND LOCK & RIDE FLEX ADAPTER KIT



TALL

Black | **2884456** \* TOP SELLER

Liner Bag - Large | **2889263**

### CARBON FIBER COLOR OPTIONS

- Orange Burst **2890624**
- Neon **2890625**

ALL MATRYX, ALL AXYS & PRO-RIDE 128 AND LONGER WITH FULL TUNNEL AND LOCK & RIDE FLEX ADAPTER KIT



**42**  
LITERS



## M2 JOURNEY BAG

MATRYX AXYS PRO-RIDE



- Great for longer rides with extra storage capacity and durable compression molded material
- Seamlessly fits behind the M2 Passenger seat to maximize storage on MATRYX snowmobiles with a 137 tunnel and longer
- Semi-rigid design and water-resistant base keeps your gear protected

**2889228**

ALL MATRYX, ALL AXYS & PRO-RIDE 128 AND LONGER WITH FULL TUNNEL AND LOCK & RIDE FLEX ADAPTER KIT

## CARGO BOX FT2 2-UP-SEAT

- Cargo Box FT2 2-Up seat 144" - 155" AXYS (Can not be used with 2883714 Under seat bag.)

P287





**LR LOCK & RIDE FLEX**  
**ADVENTURE RACK WITH SKI/SNOWBOARD ATTACHMENT**  
 MATRYX | AXYS | PRO-RIDE

- Get more out of your ride with the versatility of the Adventure Rack
- Skiing and snowboarding has never been easier; add the Ski and Snowboard Attachment to the Adventure Rack for a fully integrated solution
- Size medium - fits on tunnel lengths 136" and longer-use with size Small Lock & Ride Flex storage bags on 155" tunnels and longer

**A** Adventure Rack | 2890018  
**B** Ski/Snowboard Attachment | 2890017  
 ALL MATRYX 136 AND LONGER, ALL AXYS & PRO-RIDE 136 AND LONGER WITH FULL TUNNEL AND LOCK & RIDE FLEX ADAPTER KIT



**NEW**  
**ULTIMATE ADVENTURE SADDLE BAG**  
 MATRYX | AXYS | PRO-RIDE

- Add even more versatility to the Adventure Rack (2890018) with this saddlebag that can be added to one or both sides of the rack
- Roll top design keeps water out and includes built-in storage pockets to keep smaller items secure
- Features magnetic Fidlock® buckles for easy and secure use in the cold even with gloves on
- Requires the Adventure Rack (2890018), sold separately

2890612  
 ALL MATRYX 136 AND LONGER, ALL AXYS & PRO-RIDE 136 AND LONGER WITH FULL TUNNEL AND LOCK & RIDE FLEX ADAPTER KIT



**NEW**  
**ADVENTURE RACK BAG**  
 MATRYX | AXYS | PRO-RIDE

- Keep your gear dry with water resistant material
- Includes 1 large roll top compartment, and 1 small rolltop compartment
- Adjustable organizer with zipper and pockets; additional zipper pockets throughout the bag
- Features magnetic Fidlock® buckles for easy and secure use in the cold even with gloves on
- Adventure Rack (2890018) required, sold separately

2890599  
 ALL MATRYX 136 AND LONGER, ALL AXYS & PRO-RIDE 136 AND LONGER WITH FULL TUNNEL AND LOCK & RIDE FLEX ADAPTER KIT



**LR LOCK & RIDE FLEX**  
**BURANDT BAG - MEDIUM** MATRYX | AXYS | PRO-RIDE

- Compression molded, turtle shell design for enhanced weather resistance
- Oversized buckles provide easy access to gear with your gloves on
- Integrated mounts for spare shovel jacket enabling riders to carry a secondary shovel
- Installation on AXYS and Pro-Ride sleds requires the Lock & Ride Flex Adapter Kit (2884939), sold separately

Black | 2889258 **TOP SELLER**  
 Liner Bag - Medium | 2889349

**CARBON FIBER COLOR OPTIONS WITH ROLL TOP LINER**

Indy Red	2889895
Sky Blue	2890631
Polaris Blue	2889896
Neon	2890632
Radiant Green	2890633

ALL MATRYX, ALL AXYS & PRO-RIDE 128 AND LONGER WITH FULL TUNNEL AND LOCK & RIDE FLEX ADAPTER KIT



**LR LOCK & RIDE FLEX**  
**BURANDT BAG - LARGE** MATRYX | AXYS | PRO-RIDE

- Compression molded, turtle shell design for enhanced weather resistance
- Oversized buckles provide easy access to gear with your gloves on
- Integrated mounts for spare shovel jacket enabling riders to carry a secondary shovel
- Installation on AXYS and Pro-Ride sleds requires the Lock & Ride Flex Adapter Kit (2884939), sold separately

Black | 2889259 **TOP SELLER**  
 Liner Bag - Large | 2889350

**CARBON FIBER COLOR OPTIONS WITH ROLL TOP LINER**

Indy Red	2889898
Polaris Blue	2889899
Neon	2890634

ALL MATRYX 155 AND LONGER, ALL AXYS & PRO-RIDE 155 AND LONGER WITH FULL TUNNEL AND LOCK & RIDE FLEX ADAPTER KIT

**MATRYX - STORAGE**



**2.7**  
LITERS

**GOGGLE HANDLEBAR BAG**

MATRYX AXYS

- Conveniently access spare goggles from the driver's seat
- 2882823**  
ALL MATRYX RMK, ALL AXYS RMK



**7.6**  
LITERS

**GLOVE BOX LINER** MATRYX

- Convenient, organized storage
- Features 4 separate compartments to keep your important items secure
- Compartments seamlessly line the storage area behind your display

**2884753** **TOP SELLER**  
ALL MATRYX



**DASH STORAGE BAG** MATRYX

- 100% waterproof, premium storage bag
- Features waterproof material and zipper access for convenient access and maximum protection of your valuables
- Fits seamlessly into the storage compartment behind your display

**2889776** **TOP SELLER**  
ALL MATRYX



**NEW**  
**TRAIL HANDLEBAR PADDED STORAGE** MATRYX AXYS

- Complete the look of your handlebars with the seamlessly integrated Handlebar Pad
- Provides additional padding and protection on handlebars
- Built in storage compartment to fit your essentials

TP/CO | **2890614**  
ALL MATRYX INDY & SWITCHBACK  
FITS MATRYX VOYAGEUR WITH RISER BAR HOOP REMOVED



2890620

8.5 LITERS

**RMK ESSENTIALS BAG** MATRYX

- Lock & Ride Flex storage can be added to the back of the bag
- Bag takes up a small position on the tunnel

Black | 2889257

**CARBON FIBER COLOR OPTIONS**

Indy Red		2890621
Sky Blue		2890620
Neon		2890619

ALL MATRYX RMK

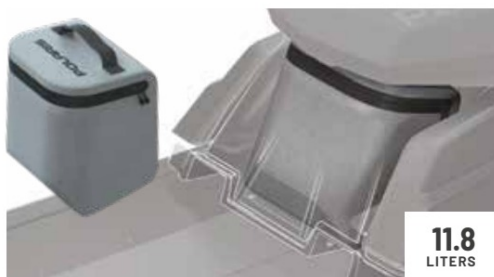

11.8 LITERS

**UNDERSEAT LINER BAG** MATRYX

- Fits inside factory underseat compartment for waterproof storage

2884752

ALL MATRYX INDY, SWITCHBACK & VOYAGEUR



**SPARE SHOVEL JACKET**

MATRYX AXYS PRO-RIDE

- Provides a perfect location to bring a secondary shovel on your sled
- Attaches directly to lids of both Medium and Large Lock & Ride Flex Burandt Tunnel Bags
- Riders should always carry their primary shovel in their avalanche backpack

Jacket | 2889322 ★ TOP SELLER

ALL SNOWMOBILES EQUIPPED WITH A LOCK & RIDE FLEX BURANDT BAG

PIEPS® Shovel T 825 Pro + With Saw Blade | 2883680

ALL SNOWMOBILES



2 PAC

**RATCHET STRAP 2000KG**

- Keep your Snowmobile, ATV or Ranger safely strapped at your trailer.
- Dimension 3,5cm/ 50cm/ 550cm
- Max load 2000kg/ working load 1000kg
- 2 pac

POL05031

**MATRYX - LIGHTING**

# LIGHT UP THE NIGHT

When the days just aren't long enough, don't let the dark end your ride early. Maximize your nighttime visibility with our lineup of Auxiliary Lighting options.



**GOOD: STOCK HEADLIGHT**



**NIGHTBLADE HEADLIGHT** MATRYX

- Most Polaris MATRYX sleds come stock with this state of the art lighting technology
- Six projector beam optics deliver precision lighting with an engineered pattern to deliver exceptional visibility for night riding
- Some models come with a standard LED light instead of the Nightblade. Standard LED lights are also compatible with Auxiliary Lighting Options

**BETTER: ACCESSORIZE IT**



**AUXILIARY PUNCH LIGHT** MATRYX

- Additional 1,000 lumens per side for increased visibility
- Ride confidently with an increased distance illuminated
- Provides better visibility further down the trail
- Turns on with high beam switch

2889863 ★ TOP SELLER  
ALL MATRYX



**AUXILIARY FLOOD LIGHT** MATRYX

- Additional 1,000 lumens per side for increased visibility
- Ride confidently with a wider range of visibility close to your sled
- Provides better visibility to react to your surrounding terrain
- Turns on with high beam switch

2889733 ★ TOP SELLER  
ALL MATRYX

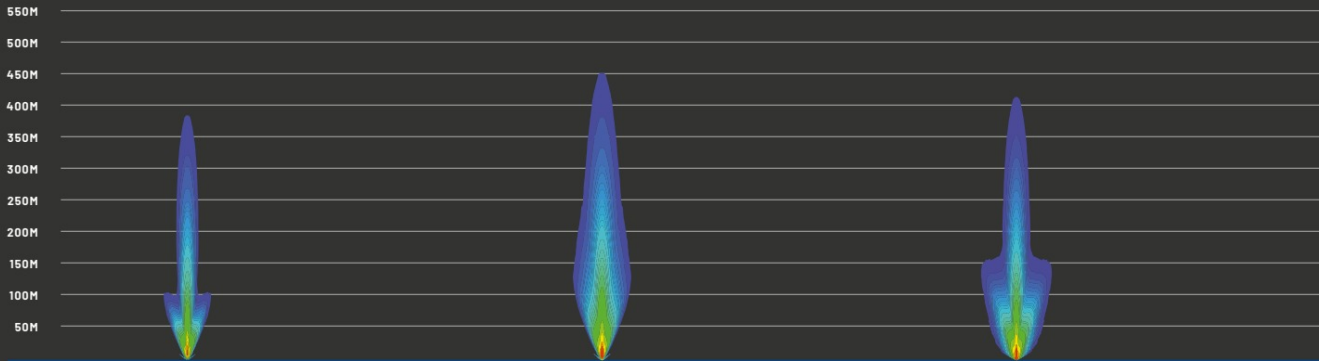

NIGHTBLADE HIGH BEAM



NIGHTBLADE HIGH BEAM + AUXILIARY PUNCH  
Best for wide open spaces & conditions requiring long distance visibility



NIGHTBLADE HIGH BEAM + AUXILIARY FLOOD  
Best for tight riding spaces, ditch approaches at night or when you need a broad light

## CUSTOM ACCENT LIGHTS



SCAN TO SHOP LIGHTING



**NEW**  
**GRILL INSERT RGB ACCENT LIGHTS** MATRYX

- Add a custom look to your vehicle with lighted grill inserts
- Use the Snow Glow app to select any color
- Easy installation, only 1 wire connector needed with minimal drilling

2890566  
ALL MATRYX



SCAN FOR  
INSTALL VIDEO



TALL

**NEW**  
**INTEGRATED CENTER AUXILIARY LIGHT WINDSHIELD** MATRYX

- Additional 2,000 lumens for increased visibility
- Ride confidently with an increased illuminated distance
- Turns on with high beam switch
- Comes with windshield - available in three different heights

Tall | 2890510  
Extra Tall | 2890642  
Full Coverage | 2890643  
ALL MATRYX

BEST: PAIR THEM UP



AUXILIARY FLOOD LIGHT



INTEGRATED CENTER AUXILIARY LIGHT WINDSHIELD



NIGHTBLADE HIGH BEAM  
+ INTEGRATED CENTER AUXILIARY LIGHT WINDSHIELD

A more focused light pattern down the trail specifically for long distance visibility

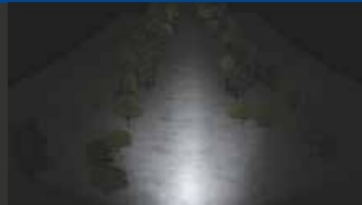

NIGHTBLADE HIGH BEAM + AUXILIARY FLOOD  
+ INTEGRATED CENTER AUXILIARY LIGHT WINDSHIELD

Optimal configuration for maximum visibility



**NEW**  
**RGB LIGHTED HOOD LOGO** MATRYX

- Add a custom look to your vehicle with the lighted hood logo
- Use the Snow Glow app to select any color
- Easy installation, only 1 wire connector needed with minimal drilling

2890424  
ALL MATRYX



**NEW**  
**HANDGUARD RGB ACCENT LIGHTS** MATRYX

- Add a custom look to your vehicle with the lighted handguards
- Use the Snow Glow app to select any color
- Easy installation, plug & play solution
- Defend Handguards required, sold separately

2890509  
ALL MATRYX

LOOK & RIDE  
FLEX

COVERS

POLARIS  
PARTNERS

CONNECTED  
TECHNOLOGY

MATRYX

AXYS

PRO-RIDE

RIDE  
READINESS

COLOR  
CUSTOMIZATION

TRANSPORT

TRACTION  
& CONTROL

TRACKS

## MATRYX - RIDER COMFORT



### **NEW** RMK DRIVER GAUNTLETS MATRYX

- Keep hands warm and dry in the backcountry with semi-rigid design
- Specifically designed for the most extreme level of backcountry riding
- Remove or add on the fly with an allen wrench

2890603  
ALL MATRYX RMK



### ULTIMATE KNEE PADS MATRYX

- One pair of knee pads
- Provides protection to knees from bumps against the console
- High quality, durable foam construction for lasting quality

	RMK	TP / CO
■ Steel Gray <small>* TOP SELLER</small>	2889944	2889889
■ Premium Black* <b>NEW</b>	2890666	2890669
■ Sky Blue <b>NEW</b>	2890665	2890668
■ Neon <b>NEW</b>	2890664	2890667

ALL MATRYX  
\*PREMIUM BLACK KNEE PADS HAVE EXTRA PADDING, SOFTER FOR EXTRA COMFORT



### DRIVER GAUNTLETS MATRYX

- Premium nylon construction delivers protection from cold
- Clear poly panels allow for handlebar switch visibility
- Requires Defend Handguard Mounts (2884617) for install, sold separately

2884814  
ALL MATRYX INDY, SWITCHBACK & VOYAGEUR

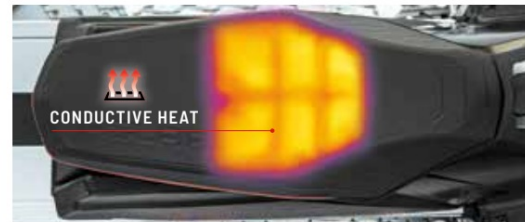

### HEATED DRIVER SEAT MATRYX

- Features easy-to-use high/low/off switch for complete control
- Complete seat assembly with all mounting hardware and harness included

2884937  
ALL MATRYX INDY, SWITCHBACK & VOYAGEUR



### INSIGHT SIDE MIRRORS MATRYX

- Keep an eye on what's behind you and ride ahead with confidence
- Side-panel mount allows for use of handguards or gauntlets

2890103 \* TOP SELLER  
ALL MATRYX INDY, SWITCHBACK & VOYAGEUR



# MATRYX - PASSENGER SEATING

**NEW**

**LR LOCK & RIDE FLEX**

## TRAIL JUMP SEAT **MATRYX**

- Seamless, lightweight passenger seat to use when you need it
- Lock & Ride Flex enabled for easy on and off, or leave it on all season with no impact on performance or feel
- Ergonomic side handles for extra grip

2890496

ALL MATRYX INDY, SWITCHBACK & VOYAGEUR



**LR LOCK & RIDE FLEX**

## M2 SEAT **MATRYX**

- All-in-one passenger seating system in standard or heated version
- Both versions come with heated grips
- Heated M2 Seat adds additional comfort for your passenger by adding a heating element to the base of the seat
- Not compatible with Lock & Ride Flex Adapter Kit
- Suspension adjustment required for optimal 2-up riding performance

Standard | 2884725

Heated | 2884957 **★ TOP SELLER**

ALL MATRYX INDY, SWITCHBACK & VOYAGEUR



## M2 PASSENGER GAUNTLETS **MATRYX**

- Passenger gauntlets for the M2 Seat
- Made from compression molded nylon
- Utilizes faux fur lining to provide additional warmth to the passenger's hands

2889364

ALL MATRYX INDY, SWITCHBACK & VOYAGEUR, REQUIRES M2 PASSENGER SEAT (2884725 OR 2884957), SOLD SEPARATELY



## NORDIC PRO CARGO BOXES

- Easy installation with Lock and Ride
- Divider and several mounting brackets for cargo straps inside
- Axe/Saw-holder
- 2884939 L&R Flex is needed to install Bag on top, sold separately
- Lock and ride kit for mounting on top of Nordic Pro box P271 and Titan box P263. Can be used with: Adventure Tunnel Bag Low 2884455, Adventure Tunnel Bag Tall 2884456, Burandt Bag Medium 2889258

P271

Large box which will fit most of your storage needs. - **105L**

P272

Medium size box for Nordic Pro with 2-up seat attached. - **80L**

PICTURED WITH SMALL BURANT BAG. NOT INCLUDED



**80-105**  
LITERS

## M2 SEAT STORAGE BAG **MATRYX**

- Semi-rigid design fits securely beneath accessory M2 seat leaving room for additional tunnel storage

2884956

ALL MATRYX INDY, SWITCHBACK & VOYAGEUR, REQUIRES M2 PASSENGER SEAT (2884725 OR 2884957), SOLD SEPARATELY



## REAR TORSION SPRING KITS **MATRYX** **AXYS**

CUSTOMIZE YOUR RIDE BASED ON TOTAL RIDER WEIGHT (COMBINED WEIGHT OF RIDER, GEAR AND/OR PASSENGER)

2884973	129/137 Light Duty
2884974	129/137 Heavy Duty
2884975	129/137 Extra Heavy Duty

ALL MATRYX/AXYS 129 & 137

2884976	144/146 Light Duty
2884977	144/146 Heavy Duty

ALL MATRYX SWITCHBACK ASSAULT, XC, AND SP, AXYS SWITCHBACK ASSAULT 144

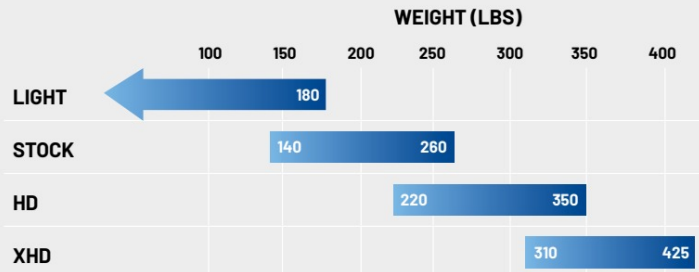

ACCESSORIES

LOCK & RIDE FLEX

COVERS

POLARIS PARTNERS

CONNECTED TECHNOLOGY

MATRYX

AXYS

PRO-RIDE

RISE READINESS

COLOR CUSTOMIZATION

TRANSPORT

TRACTION & CONTROL

TRACKS

## MATRYX - WINDSHIELDS

# FIND THE RIGHT WINDSHIELD FOR YOU

Easily modify to your desired level of wind protection with the adjustable windshield, or find the right windshield built for the type of riding you do most.

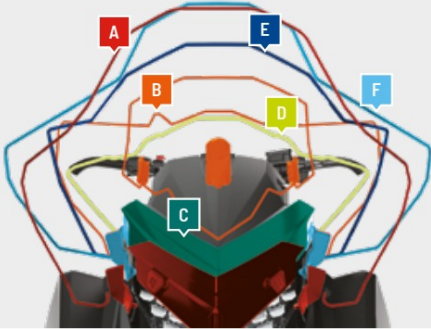

C



### BEZEL MATRYX

■ Gloss Black	2884936-266
■ Indy Red	2884936-293
■ Orange Burst	2884936-647
■ Sky Blue	2884936-737
■ Polaris Blue	2884936-751
■ Plum Crazy	2884936-784
■ Neon	2884936-801

ALL MATRYX

E

23"  
TALL

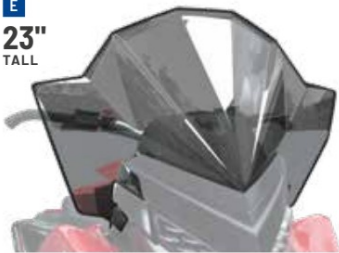

### TALL WINDSHIELD MATRYX

■ Smoke	2884935
---------	---------

ALL MATRYX. COMPATIBLE WITH HANDGUARDS WITH HANDLEBAR POSITION ADJUSTMENT

A

29"  
TALL

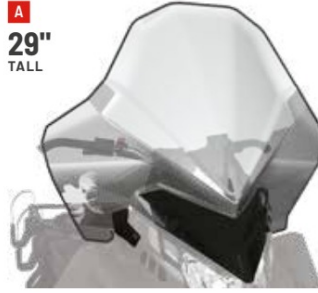

### ALASKAN WINDSHIELD MATRYX

✕ Clear	2890350
---------	---------

ALL MATRYX

23"-27"  
TALL



### EXTRA LARGE ADJUSTABLE WINDSHIELD MATRYX

✕ Clear	2889865
---------	---------

ALL MATRYX, NOT COMPATIBLE WITH HANDGUARDS

B

20"-24"  
TALL

### ADJUSTABLE WINDSHIELD MATRYX

✕ Clear	2889255
---------	---------

ALL MATRYX

D

15"  
TALL



### DEEP SNOW LOW WINDSHIELD MATRYX

■ Dark Smoke	2889405
--------------	---------

ALL MATRYX

20"  
TALL

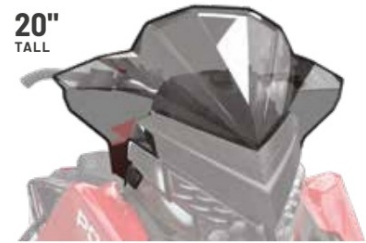

### MID WINDSHIELD MATRYX

■ Dark Smoke	2884934
--------------	---------

ALL MATRYX

24"  
TALL



### EXTRA TALL WINDSHIELD MATRYX

✕ Clear	2885128
✕ Clear with Polaris Graphic	2889202

ALL MATRYX, NOT COMPATIBLE WITH HANDGUARDS

F

25"  
TALL

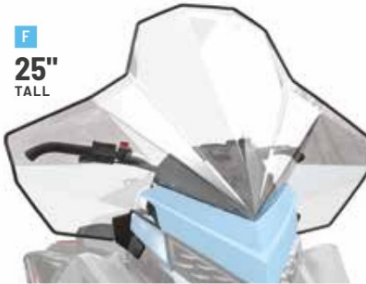

### FULL COVERAGE WINDSHIELD MATRYX

✕ Clear	2889256
---------	---------

ALL MATRYX, NOT COMPATIBLE WITH HANDGUARDS

# MATRYX - HANDLEBARS & GUARDS



## RMK NARROW HANDLEBARS MATRYX

- ProTaper® handlebars with the same style as the factory handlebars
- Narrow RMK Handlebar has a reduced width (approximately 1.5 in narrower)
- Provides better control with precise steering
- More accurate hand heating from the heated handlebar grips

5" Rise	2889358
6" Rise	2889359
7" Rise	2889360

ALL MATRYX RMK, ALL AXYS RMK



## RMK HANDLEBAR ADJUSTABLE MOUNT MATRYX AXYS

- Get the perfect fit on your handlebars with the RMK Handlebar Adjustable Mount
- Reduce the strain on your body with a more natural and effortless feel
- Ride easy knowing that your grip is firm and your arms are stable

2889867  
ALL MATRYX AND AXYS RMK



## RMK BACKCOUNTRY HAND GUARDS MATRYX AXYS

- Provides the ultimate protection for your hands
- Sold in pairs
- Mounts included

Black | 2889868

### CARBON FIBER COLOR OPTIONS

	Indy Red	2890600
	Sky Blue	2890601
	Neon	2890602

ALL MATRYX AND AXYS RMK



## ★ TOP SELLER DEFEND HANDGUARDS MATRYX

- Oversized design offers increased protection and warmth; factory-color-matched

	Gloss Black	2884616-266
	Indy Red	2884616-293
	White	2884616-599

ALL MATRYX, NOT COMPATIBLE WITH XL ADJUSTABLE, EXTRA TALL OR FULL COVERAGE WINDSHIELDS  
REQUIRES DEFEND HANDGUARD MOUNTS, SOLD SEPARATELY



## ★ TOP SELLER DEFEND HANDGUARD SIGNATURE LIGHT MATRYX

- Elevated customization with signature accent lighting for handguards

2884933  
ALL MATRYX  
REQUIRES DEFEND HANDGUARDS & DEFEND HANDGUARD MOUNTS, EACH SOLD SEPARATELY

## HANDGUARD RGB ACCENT LIGHTS MATRYX

2890509  
ALL MATRYX  
DEFEND HANDGUARDS & DEFEND HANDGUARD MOUNTS REQUIRED, EACH SOLD SEPARATELY, SEE P. 79 FOR MORE DETAILS

## DEFEND HANDGUARD MOUNTS MATRYX

- Made of durable and strong, yet flexible injection molded plastic
- Mounts are required to install Defend Handguards

2889305  
ALL MATRYX RMK  
2884617  
ALL MATRYX INDY, SWITCHBACK & VOYAGEUR



## MATRYX - COLOR CUSTOMIZATION & PROTECTION

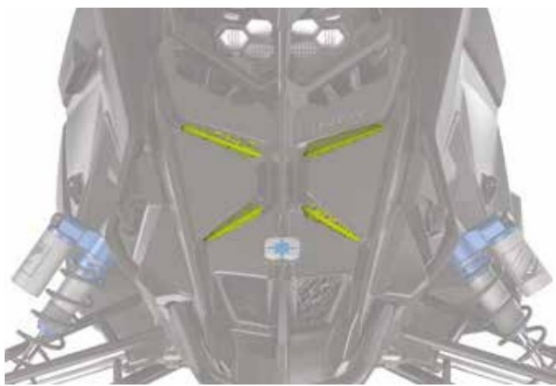

★ TOP SELLER

### GRILL INSERTS MATRYX

- Provides enhanced, custom style to your sled
- Custom painted and color matched for optimal styling

■ Gloss Black	2884979-067
■ Indy Red	2884979-293
■ Orange Burst	2884979-647
■ Sky Blue	2884979-737
■ Polaris Blue	2884979-751
■ Plum Crazy	2884979-784
■ Neon	2884979-801
■ Stealth Gray	2884979-804
■ Radiant Green	2884979-887

ALL MATRYX



★ TOP SELLER

### SENTRY SKID PLATE MATRYX

- Protect your sled from unexpected obstacles with this skid plate
- Rugged, custom design fits perfectly to the underside of your sled, dramatically increasing impact resistance and letting you ride ahead with confidence
- Color-matched custom style to compliment the look of your machine
- Installs easily and quickly
- Constructed from tough, durable UHMW plastic
- Includes all mounting hardware

■ Black	2884816-070
□ Bright White	2884816-133
■ Indy Red	2884816-293
■ Polaris Blue	2884816-751
■ Neon	2884816-801

ALL MATRYX

### **NEW** GRILL INSERT RGB ACCENT LIGHTS MATRYX

- Add a custom look to your vehicle with lighted grill inserts
- Use the Snow Glow app to select any color
- Easy installation, only 1 wire connector needed with minimal drilling

2890566

ALL MATRYX



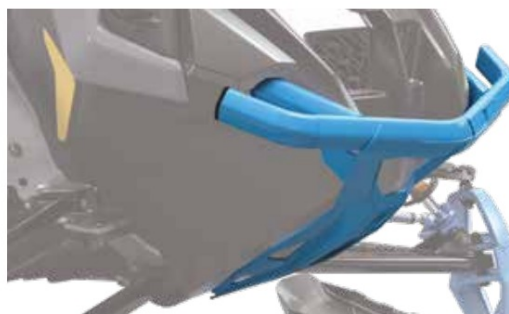

**★ TOP SELLER**  
**SENTRY FRONT BUMPER** **MATRYX**

- Engineered for a custom fit to align with the overall design of your sled
- Features color-matched style, so you don't compromise looks for utility

■ Gloss Black	2884817-067
□ Bright White	2884817-133
■ Indy Red	2884817-293
■ Turbo Silver	2884817-402
■ Orange Burst	2884817-647
■ Sky Blue	2884817-737
■ Polaris Blue	2884817-751
■ Plum Crazy	2884817-784
■ Neon	2884817-801
■ Stealth Gray	2884817-804
■ Radiant Green	2884817-887

ALL MATRYX



**SENTRY TRAIL REAR BUMPER** **MATRYX** **AXYS**

- Equip yourself for any condition and any trail with this Rear Bumper
- Made from High Grade Aluminum, this bumper stands up to the roughest trails
- Available in a variety of powder-coated colors to match the overall style of your sled
- Rear grab bar is easy to use with gloved hands

■ Gloss Black	2884257-067
□ Bright White	2884257-133
■ Indy Red	2884257-293
■ Turbo Silver	2884257-402
■ Orange Burst	2884257-647
■ Velocity Blue	2884257-689
■ Sky Blue	2884257-737
■ Polaris Blue	2884257-751
■ Stealth Gray	2884257-804

ALL AXYS 129, 137 AND 144/146 SWITCHBACK, ALL MATRYX INDY, SWITCHBACK & VOYAGEUR

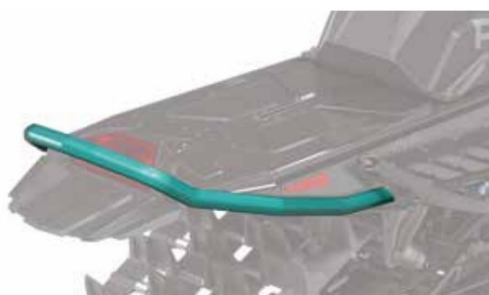

**SENTRY MOUNTAIN REAR BUMPER** **MATRYX**

- Add a custom look and great protection to your sled
- Comes stock and in a variety of colors on RMK sleds
- The rear grab bar is easy to use with gloved hands

	146"	155" SLASH	155"/163"/165"
■ Gloss Black*	2889351-067	2889352-067	2889353-067
■ Indy Red	2889351-293	2889352-293	2889353-293
■ Turbo Silver	2889351-402	2889352-402	2889353-402
■ Orange Burst	2889351-647	2889352-647	2889353-647
■ Sky Blue	2889351-737	2889352-737	2889353-737
■ Polaris Blue	2889351-751	2889352-751	2889353-751
■ Plum Crazy	2889351-784	2889352-784	2889353-784
■ Neon	2889351-801	2889352-801	2889353-801
■ Stealth Gray	2889351-804	2889352-804	2889353-804
■ Radiant Green	2889351-887	2889352-887	2889353-887

146" FITMENT: ALL MATRYX RMK KHAOS 146  
 155" SLASH FITMENT: ALL MATRYX SLASH RMK 155  
 155"/163"/165" FITMENT: ALL MATRYX RMK 155/163/165 AND 163/165 SLASH  
 \*STOCK REAR BUMPER ON ALL MATRYX RMK MODELS



# AXYS

The proven AXYS platform delivers rider-balanced control and unrivaled acceleration. Our comprehensive collection of accessories includes everything needed to customize your sled's style, storage, comfort and protection to truly make it your own.

## **RMK**

MY20-22 AXYS KHAOS  
MY16-22 AXYS PRO RMK  
MY16-21 SKS  
MY16-19 ASSAULT

## **SWITCHBACK**

MY17-21 ASSAULT  
MY15-21 PRO-S/PRO-X/XCR  
MY17-19 SP

## **INDY**

MY20-21 ADVENTURE/XC 137  
MY20-21 XCR  
MY19-21 XC 129

## **RUSH**

MY15-20 RUSH

## **VOYAGEUR**

MY17-21 600

## **TITAN**

MY18-24 ADVENTURE  
MY18-22 XC  
MY18-21 SP

**AXYS - STORAGE**



RETROFIT YOUR SLED WITH  
**LOCK & RIDE FLEX**



**LOCK & RIDE FLEX ADAPTER KIT**

AXYS PRO-RIDE

• Add Lock & Ride Flex storage to AXYS and Pro-Ride full tunnel sleds

2884939 **TOP SELLER**

ALL PRO-RIDE & AXYS SLEDS W/ TUNNEL T-SLOTS, NOT COMPATIBLE WITH LOCK & RIDE FLEX M2 SEAT



**SPORT TUNNEL BAG**  
 MATRYX AXYS PRO-RIDE

Low | 2884453  
 ALL MATRYX, ALL AXYS & PRO-RIDE 121 AND LONGER WITH FULL TUNNEL AND LOCK & RIDE FLEX ADAPTER KIT



Liner Bag - Small  
 2889260

Tall | 2884454  
 ALL MATRYX, ALL AXYS & PRO-RIDE 121 AND LONGER WITH FULL TUNNEL AND LOCK & RIDE FLEX ADAPTER KIT



Liner Bag - Large  
 2889261



**WATERPROOF ROLL TOP BAG**  
 MATRYX AXYS PRO-RIDE

• Our highest level of moisture resistance, built to protect your valuables  
 • Roll top design allows for quick and easy access

2890008

ALL MATRYX, ALL AXYS & PRO-RIDE 121 AND LONGER WITH FULL TUNNEL AND LOCK & RIDE FLEX ADAPTER KIT



## AXYS - STORAGE



### ADVENTURE TUNNEL BAG

MATRIXX AXYS PRO-RIDE

**LOW**  
 Black | 2884455  
 Liner Bag - Small | 2889262

**TALL**  
 Black | 2884456 **★ TOP SELLER**  
 Liner Bag - Large | 2889263



**LOW CARBON FIBER COLOR OPTIONS**

Sky Blue	2890622
Neon	2890623

**TALL CARBON FIBER COLOR OPTIONS**

Orange Burst	2890624
Neon	2890625

ALL MATRIXX, ALL AXYS & PRO-RIDE 128 AND LONGER WITH FULL TUNNEL AND LOCK & RIDE FLEX ADAPTER KIT

ALL MATRIXX, ALL AXYS & PRO-RIDE 128 AND LONGER WITH FULL TUNNEL AND LOCK & RIDE FLEX ADAPTER KIT



### BURANDT BAG - MEDIUM

MATRIXX AXYS PRO-RIDE

- Compression molded, turtle shell design for enhanced weather resistance
- Oversized buckles provide easy access to gear with your gloves on
- Integrated mounts for spare shovel jacket enabling riders to carry a secondary shovel
- Installation on AXYS and Pro-Ride sleds requires the Lock & Ride Flex Adapter Kit (2884939), sold separately

Black | 2889258 **★ TOP SELLER**  
 Liner Bag - Medium | 2889349

**CARBON FIBER COLOR OPTIONS WITH ROLL TOP LINER**

Indy Red	2889895
Sky Blue	2890631
Polaris Blue	2889896
Neon	2890632
Radiant Green	2890633

ALL MATRIXX, ALL AXYS & PRO-RIDE 128 AND LONGER WITH FULL TUNNEL AND LOCK & RIDE FLEX ADAPTER KIT



### BURANDT BAG - LARGE

MATRIXX AXYS PRO-RIDE

- Compression molded, turtle shell design for enhanced weather resistance
- Oversized buckles provide easy access to gear with your gloves on
- Integrated mounts for spare shovel jacket enabling riders to carry a secondary shovel
- Installation on AXYS and Pro-Ride sleds requires the Lock & Ride Flex Adapter Kit (2884939), sold separately

Black | 2889259 **★ TOP SELLER**  
 Liner Bag - Large | 2889350

**CARBON FIBER COLOR OPTIONS WITH ROLL TOP LINER**

Indy Red	2889898
Polaris Blue	2889899
Neon	2890634

ALL MATRIXX 155 AND LONGER, ALL AXYS & PRO-RIDE 155 AND LONGER WITH FULL TUNNEL AND LOCK & RIDE FLEX ADAPTER KIT



### SPARE SHOVEL JACKET

MATRIXX AXYS PRO-RIDE

- Provides a perfect location to bring a secondary shovel on your sled
- Attaches directly to lids of both Small and Large Lock & Ride Flex Burandt Tunnel Bags

Jacket | 2889322 **★ TOP SELLER**  
 ALL SNOWMOBILES EQUIPPED WITH A LOCK & RIDE FLEX BURANDT BAG  
 PIEPS® Shovel T 825 Pro + With Saw Blade | 2883680  
 ALL SNOWMOBILES





### ADVENTURE RACK WITH SKI/SNOWBOARD ATTACHMENT

MATRYX | AXYS | PRO-RIDE

- Get more out of your ride with the versatility of the Adventure Rack
- Skiing and snowboarding has never been easier; add the Ski and Snowboard Attachment to the Adventure Rack for a fully integrated solution
- Size medium - fits on tunnel lengths 136" and longer-use with size Small Lock & Ride Flex storage bags on 155" tunnels and longer

A Adventure Rack | 2890018

B Ski/Snowboard Attachment | 2890017

ALL MATRYX 136 AND LONGER, ALL AXYS & PRO-RIDE 136 AND LONGER WITH FULL TUNNEL AND LOCK & RIDE FLEX ADAPTER KIT

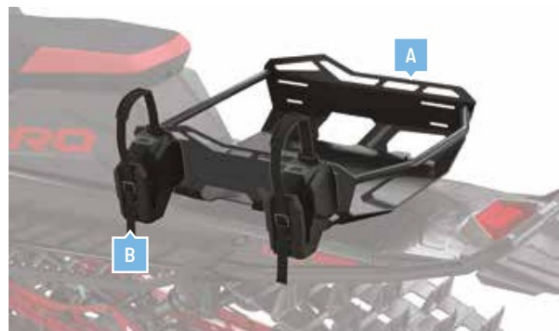

47.5 LITERS

NEW

### ADVENTURE RACK BAG

MATRYX | AXYS | PRO-RIDE

- Keep your gear dry with water resistant material
- Includes 1 large roll top compartment, and 1 small rolltop compartment
- Adjustable organizer with zipper and pockets; additional zipper pockets throughout the bag
- Features magnetic Fidlock® buckles for easy and secure use in the cold even with gloves on
- Adventure Rack (2890018) required, sold separately

2890599

ALL MATRYX 136 AND LONGER, ALL AXYS & PRO-RIDE 136 AND LONGER WITH FULL TUNNEL AND LOCK & RIDE FLEX ADAPTER KIT



6 LITERS

NEW

### ULTIMATE ADVENTURE SADDLE BAG

MATRYX | AXYS | PRO-RIDE

- Add even more versatility to the Adventure Rack (2890018) with this saddlebag that can be added to one or both sides of the rack
- Roll top design keeps water out and includes built-in storage pockets to keep smaller items secure
- Features magnetic Fidlock® buckles for easy and secure use in the cold even with gloves on
- Adventure Rack (2890018) required, sold separately

2890612

ALL MATRYX 136 AND LONGER, ALL AXYS & PRO-RIDE 136 AND LONGER WITH FULL TUNNEL AND LOCK & RIDE FLEX ADAPTER KIT

## AXYS - STORAGE & RACKS



LOW PRO

**4**  
LITERS

LARGE

**5**  
LITERS

### WINDSHIELD BAG AXYS

- Bag installs inside base of windshield using stock push-dart fasteners
- Compression-molded semi-rigid material
- Engine heat warms/dries goggles and gloves

**A** Low Pro | 2880481  
Large | 2880374  
ALL AXYS



**9.8**  
LITERS

### MOUNTAIN DASH BAG AXYS

- Convenient storage for two bottles of water, goggles, gloves, or anything else you need easy access to

**B** 2880375  
AXYS PRO-RMK MY16-22, SKS 155 MY16-21, RMK ASSAULT MY16-20



**2.7**  
LITERS

### GOGGLE HANDLEBAR BAG

MATRYX AXYS

- Conveniently access spare goggles from the driver's seat

**C** 2882823  
ALL MATRYX, ALL AXYS





**ADVENTURE TUNNEL BAG LINER**

- Provides secure, waterproof storage for gear
- Features a waterproof zipper
- Has a large handle for convenient carrying

2889114

ALL ADVENTURE TUNNEL BAG 1.0 (2882816) EQUIPPED SNOWMOBILES



46.4 LITERS

**ADVENTURE TUNNEL BAG 1.0** AXYS PRO-RIDE

- 2" buckles make it easy to access your gear with gloves on
- Includes two waterproof duffels to easily bring gear inside after the ride
- Ample storage space to carry everything you need

2882816

ALL INDY 129, INDY 137, SBA 144, PRO-RMK

**CARGO BAG 144"**

AXYS PRO-RIDE

- Semi-compressed with nylon side bag installs securely in cargo rack
- Versatile bag can be converted to a single large-cargo compartment

2881968

MY17-21 AXYS 144, MY18-21 SKS 146, ALL 550 AND 600 VOYAGEUR MODELS  
REQUIRES CARGO RACK 144" (2881940-458), SOLD SEPARATELY



42 LITERS

**BURANDT ADVENTURE UNDERSEAT BAG** AXYS

- Dual side-access zippers provide access to cargo when bag is installed

2881056

MY16-21 AXYS PRO-RMK, AXYS SKS, AXYS RMK ASSAULT



7.7 LITERS



**CARGO BOX VOYAGEUR 155** AXYS PRO-RIDE

P261

INDY 550 VOYAGEUR 155 15-16 155", 15-16, 2017-2018 WITH CARGO RACK 288275 INSTALLED

P288

VOYAGEUR 600 144" 2017-2021 (NOT IN PICTURE)

P294

550LXT 144" -2021, SWB 144" (WITH CARGO RACK 2881940-458 INSTALLED, (NOT IN PICTURE))



**NEW** LOCK & RIDE

**RMK CARGO RACK** AXYS PRO-RIDE

Cargo Box RMK 155" | P285

Cargo Box RMK 144" | P286



## AXYS - PASSENGER SEATING

### LOCK & RIDE

#### FT2 PASSENGER SEAT **AXYS**

- Includes backrest, seat and handholds
- Heated grips and plug-in for passenger's heated visor
- Installs/removes easily with Lock & Ride technology
- Requires FT2 Rear Seat Rack (2883646), sold separately

Standard | 2883637

ALL AXYS INDY FULL TUNNEL SNOWMOBILES,  
AND AXYS SWITCHBACK ASSAULT

Heated  | 2884208

ALL AXYS INDY FULL TUNNEL SNOWMOBILES,  
AND AXYS SWITCHBACK ASSAULT

### LOCK & RIDE

#### FT2 REAR SEAT RACK **AXYS**

- Attaches via Lock & Ride technology
- Made of powder-coated high-quality steel

2883646

ALL AXYS INDY FULL TUNNEL SNOWMOBILES,  
AND AXYS SWITCHBACK ASSAULT

#### FT2 UNDER-RACK BAG **AXYS**

- Easy access with weather-resistant zipper
- Compression-molded design provides rigidity
- Attaches directly to rack with water-resistant Velcro®

2883714

ALL AXYS INDY FULL TUNNEL SNOWMOBILES,  
AND AXYS SWITCHBACK ASSAULT



**NEW**

#### CARGO BOX FT2 2-UP-SEAT

- Cargo Box FT2 2-Up seat 144" - 155" AXYS  
(Can not be used with 2883714 Under seat bag.)
- P287

**45**  
LITERS





**HAND-WARMER POWER KIT** AXYS

- Required to power the passenger hand-warmers on MY17-18 AXYS 144 sleds
- 2883851**  
ALL MY18 AXYS 600/800 137 & 144 SWITCHBACK ASSAULT

**PASSENGER FOOTRESTS** AXYS

- Add passenger comfort and security with passenger footrests
- Extruded aluminum design attaches directly to running board

SWITCHBACK 137 | **2882817**  
AXYS SWITCHBACK

AXYS 129/137/144 | **2883571**  
MY19-21 AXYS INDY XC 129, MY17-21 SWITCHBACK  
ASSAULT 144



**REAR TORSION SPRING KITS** MATRYX AXYS

**CUSTOMIZE YOUR RIDE BASED ON TOTAL RIDER WEIGHT  
(COMBINED WEIGHT OF RIDER, GEAR AND/OR PASSENGER)**

2884973	129/137 Light Duty
2884974	129/137 Heavy Duty
2884975	129/137 Extra Heavy Duty

ALL MATRYX/AXYS 129 & 137 SNOWMOBILES

2884976	144/146 Light Duty
2884977	144/146 Heavy Duty

ALL MATRYX SWITCHBACK ASSAULT 146, AXYS  
SWITCHBACK ASSAULT 144

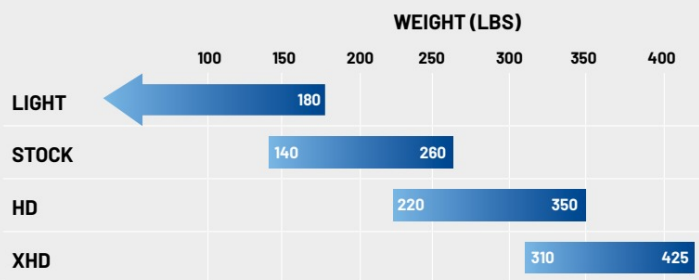

## AXYS - RIDER COMFORT

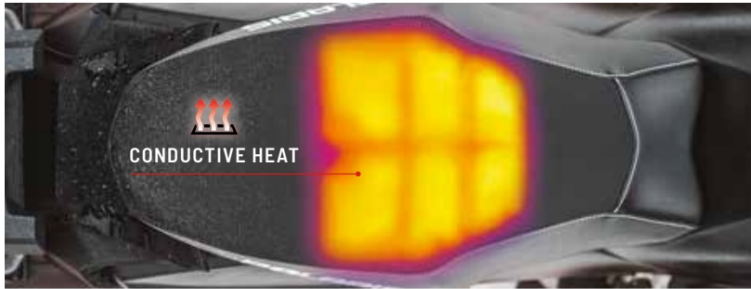

### HEATED SEAT **AXYS**

- Features easy-to-use high/low/off switch for complete control
- Complete seat assembly with all mounting hardware and harness included

Black | 2882819

ALL AXYS 120 - 146 SNOWMOBILES



### **NEW** AXYS TP/CO KNEE PADS **AXYS**

- One pair of knee pads
- Provides protection from bumps against the console
- High quality, durable foam construction for lasting quality

Gray/Black | 2890663

ALL AXYS 120 - 146 SNOWMOBILES



### RMK BACKCOUNTRY HAND GUARDS **MATRYX** **AXYS**

- Provides the ultimate protection for your hands
- Sold in pairs
- Mounts included

Black | 2889868

#### CARBON FIBER COLOR OPTIONS

<b>NEW</b> Indy Red	2890600
<b>NEW</b> Sky Blue	2890601
<b>NEW</b> Neon	2890602

ALL MATRYX AND AXYS RMK



### XL HANDGUARDS **AXYS**

- Oversized for increased wind protection
- Durable, compression-molded design
- Mounts included

2884258

ALL AXYS

DOES NOT FIT AXYS RMK OR TITAN



### POLARIS HANDGUARDS **AXYS**

- Durable, impact-resistant plastic
- Requires Handguard Mounts, sold separately

Black <b>* TOP SELLER</b>	2879192
Red	2879193
White	2879194

ALL AXYS

REQUIRES HANDGUARD MOUNTS, SOLD SEPARATELY

### HANDGUARD MOUNTS **AXYS**

- Strong mounts ensure proper handguard installation
- Easy install: mounts directly onto handlebar

2880939

ALL AXYS 120 - 146 SNOWMOBILES, ALL TITAN

### RMK HANDGUARD MOUNTS **AXYS**

- Strong mounts ensure proper handguard installation
- Installs securely on any ProTaper® handlebar

2881241-458

ALL AXYS RMK

## AXYS - HANDLEBARS



ACCESSORIES

LOOK & RIDE  
FLEX

COVERS

POLARIS  
PARTNERS

CONNECTED  
TECHNOLOGY

MATRIX

AXYS

PRO-RIDE

RIDE  
READINESS

COLOR  
CUSTOMIZATION

TRANSPORT

TRACTION  
& CONTROL

TRACKS

95

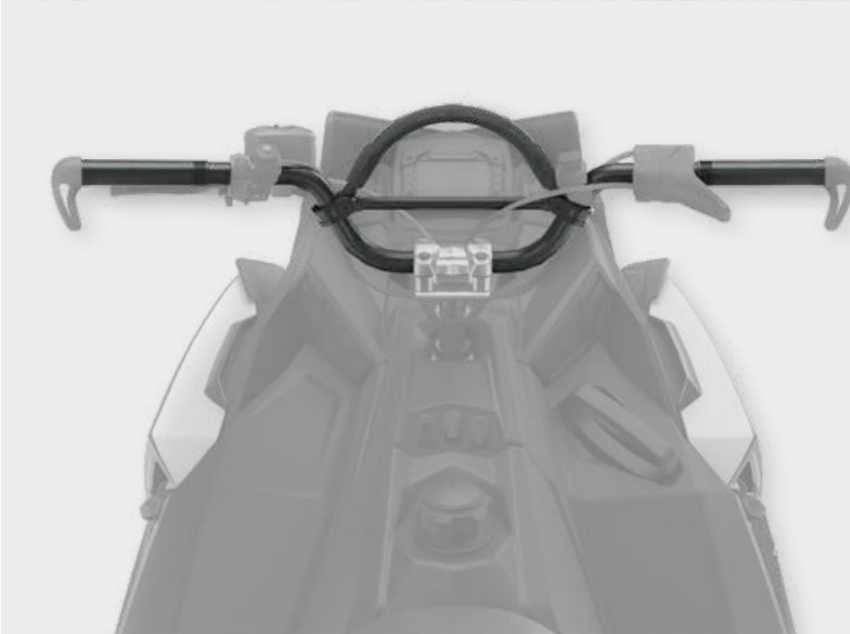

### PROTAPER® HANDLEBAR WITH HEATED GRIPS **AXYS**

- ProTaper® handlebar allows riders to customize their handlebar height for their riding style
- Handlebar hooks (1823339-070), sold separately
- These handlebars were offered in SnowCheck features and options. Explore the lineup of various sizes to change your fit

5" Rise	Black	2881235
6" Rise	Anodized Gray	2881236
7" Rise	Silver	2881237

#### ALL AXYS 800 PRO-RMK

5" Rise	Black	2883835
6" Rise	Anodized Gray	2883836
7" Rise	Silver	2883837

ALL 850 - SKS 155 '19-20, RMK KHAOS '20, PRO-RMK '19-20, PRO RMK 163 '19-20, PRO RMK 155 '19-20



### MOUNTAIN HOOP **AXYS**

2882118

ALL AXYS 120 - 148 SNOWMOBILES, ALL TITAN



### HANDLEBAR HOOK **AXYS**

2872482-070

DOES NOT FIT PROTAPER® BARS



### MIRRORS **AXYS**

- Wide-angle view
- Non-fogging glass
- Folding design for use with cover
- Includes mounting hardware
- Sold as a pair

2880292

ALL AXYS

# AXYS - WINDSHIELDS



DEEP SNOW  
MID WINDSHIELD

7"  
TALL



**LOW WINDSHIELD** AXYS

Black/Gray	2880385
Red/White	2880387
White	2882062

ALL AXYS

13"  
TALL



**DEEP SNOW MID WINDSHIELD** AXYS

White	2881054
Matte Black	2881055
Gloss Black	2882058

ALL AXYS

18"  
TALL



**FLATLAND MID WINDSHIELD** AXYS

Clear with Graphic	2880389
Gloss Black	2880390

ALL AXYS

20"  
TALL



**TALL WINDSHIELD** AXYS

Smoke <b>★ TOP SELLER</b>	2880394
---------------------------	---------

ALL AXYS

24"  
TALL

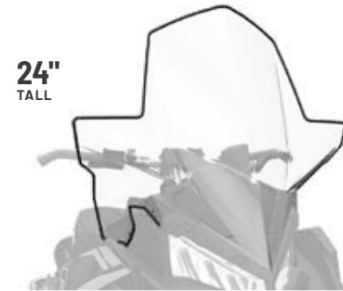

**EXTRA TALL WINDSHIELD** AXYS

Clear	2883078
-------	---------

ALL AXYS

25"  
TALL



**FULL COVERAGE WINDSHIELD** AXYS

Clear	2882786
-------	---------

ALL AXYS



## AXYS - PROTECTION

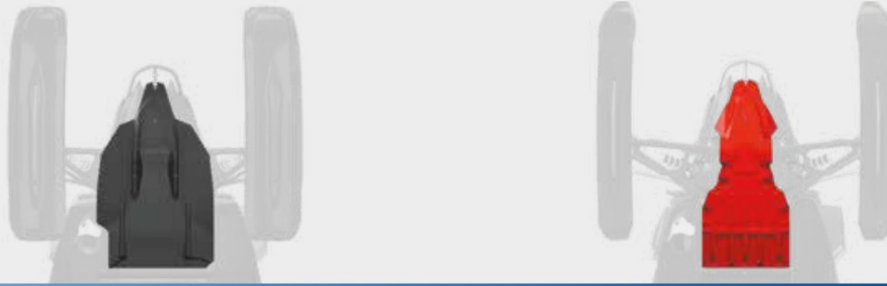

PROTECTION: MAXIMUM

MEDIUM

### HIGH COVERAGE SKID PLATE AXYS

- Provides the greatest amount of underbelly protection
- Rugged and lightweight UHMW material
- May hinder deep-snow performance
- Includes all mounting hardware

■ Black	2882748-070
---------	-------------

ALL AXYS

### ULTIMATE SKID PLATE AXYS

- Extended length delivers extra protection for belly pan and bulkhead
- Includes all mounting hardware

■ Black	2880383-070
■ Indy Red	2880383-293
■ Blue	2880383-619

ALL AXYS



### MONARCH FRONT BUMPER AXYS

□ Bright White	2883681-133
■ Indy Red	2883681-293
■ Matte Black	2883681-458
■ Matte Gold Metallic	2883681-703

ALL AXYS



### EXTREME REAR BUMPER AXYS

□ Bright White	2880993-133
■ Indy Red	2880993-293
■ Matte Black	2880993-458
■ Velocity Blue	2880993-689
■ Matte Gold Metallic	2880993-703
■ Sky Blue	2880993-737

ALL AXYS 165, 163, 165



### SENTRY TRAIL REAR BUMPER MATRYX AXYS

■ Gloss Black	2884257-067
□ Bright White	2884257-133
■ Indy Red	2884257-293
■ Orange Burst	2884257-647
■ Sky Blue	2884257-737
■ Polaris Blue	2884257-751
■ Stealth Gray	2884257-804

ALL AXYS 129, 137 AND 144/146 SWITCHBACK, ALL MATRYX INDY, SWITCHBACK & VOYAGEUR

## AXYS - TITAN



ADVENTURE TRAILER



### HD FRONT BUMPER

- Add protection to the front of your TITAN with the HD Front Bumper with integrated front-facing winch mount
- Constructed from high-strength steel and finished in black powder coat

Black | 2882794

ALL TITAN



### INTEGRATED 1,500LB WINCH

- Versatile and rugged winch can clear downed trees or retrieve a stuck snowmobile
- Includes wireless winch remote and Side Storage mount
- Mounts to rear of sled with included receiver hitch
- Mounts to front of sled when using HD Front Bumper (Requires 2883850, sold separately)

2882798

ALL TITAN

### TITAN FRONT WINCH ATTACHMENT CABLE

- Required for utilization of the winch in the front of your TITAN snowmobile

2883850

ALL TITAN



110 LITERS

### SCANDI BOX

- Largest storage option for TITAN with 165 liters of capacity
- Molded to fit seamlessly with the Versa Rear Cargo Rack
- Axe/Saw holder
- 2884939 L&R Flex is needed to install Bag on top, sold separately
- Lock and ride kit for mounting on top of Nordic Pro box P271 and Titan box P283. Can be used with: Adventure Tunnel Bag Low 2884455, Adventure Tunnel Bag Tall 2884456, Burandt Bag Medium 2889258

P282

ALL TITAN



### ICE AUGER RACK

- Premium steel rack securely holds your ice auger for easy transport

2882799

ALL TITAN



**A** **LOCK & RIDE**  
**VERSA REAR CARGO RACK**

- Rugged aluminum powder-coated rear rack delivers versatile storage solutions
- Bolts securely to tunnel and features multiple cargo tie-down points

**2882792**  
ALL TITAN  
STANDARD ON TITAN ADVENTURE

**B** **LOCK & RIDE**  
**VERSA REAR CARGO BOX**

- Heavy-duty roto-molded box mounts to rear luggage rack with Lock & Ride technology
- Easy-open hinge lid can accommodate an optional padlock for security
- A total of 60 liters of storage space

**2882793**  
ALL TITAN  
STANDARD ON TITAN ADVENTURE

**CARGO BOX  
BUNGEE NET (EXTERIOR)**

- Expands storage of the Lock & Ride Versa Rear Cargo Box
- Secure extra cargo to the exterior of the cargo box for easy access and increased capacity

**2884300**  
ALL TITAN



**SCANDI BOX**

- Cargo box with backrest, 100 liter with straps.
- Cargo can also be stored on the lid with straps.
- Molded to fit seamlessly with the TITAN Versa rack
- Axe/Saw holder
- 2884939 L&R Flex is needed to install Bag on top, sold separately
- Lock and ride kit for mounting on top of Nordic Pro box P271 and Titan box P283. Can be used with: Adventure Tunnel Bag Low 2884455, Adventure Tunnel Bag Tall 2884456, Burandt Bag Medium 2889258

**P283**  
ALL TITAN  
NOTE: (CARGO BOXES CAN ONLY BE USED WITH 1-UP SEAT , L&R SOLD SEPARATELY.



- Cargobox 110 liter with straps. Titan Adventure
- Cargo can also be stored on the lid with straps.
- Molded to fit seamlessly with the TITAN Versa rack

**P284**  
ALL TITAN

## AXYS - TITAN



### LOCK & RIDE

## VERSA TOURING PASSENGER SEAT

- Attaches/removes in seconds with Lock & Ride technology
- Heated version available
- Includes heated grips and plug-in for passenger's heated helmet visor
- Requires Versa Rear Cargo Rack (2882792), sold separately

Standard | 2882791

Heated  | 2882801

ALL TITAN

STANDARD ON TITAN ADVENTURE



## PASSENGER FOOTRESTS

- Add passenger comfort and security with passenger footrests
- Extruded aluminum design attaches directly to running board

2882797

ALL TITAN

## POLARIS TITAN HEATED SEAT

- Keep warm during the most demanding winter rides
- Features easy-to-use high/low/off switch for complete control
- Complete seat assembly with all mounting hardware and harness included

2882747  
ALL TITAN

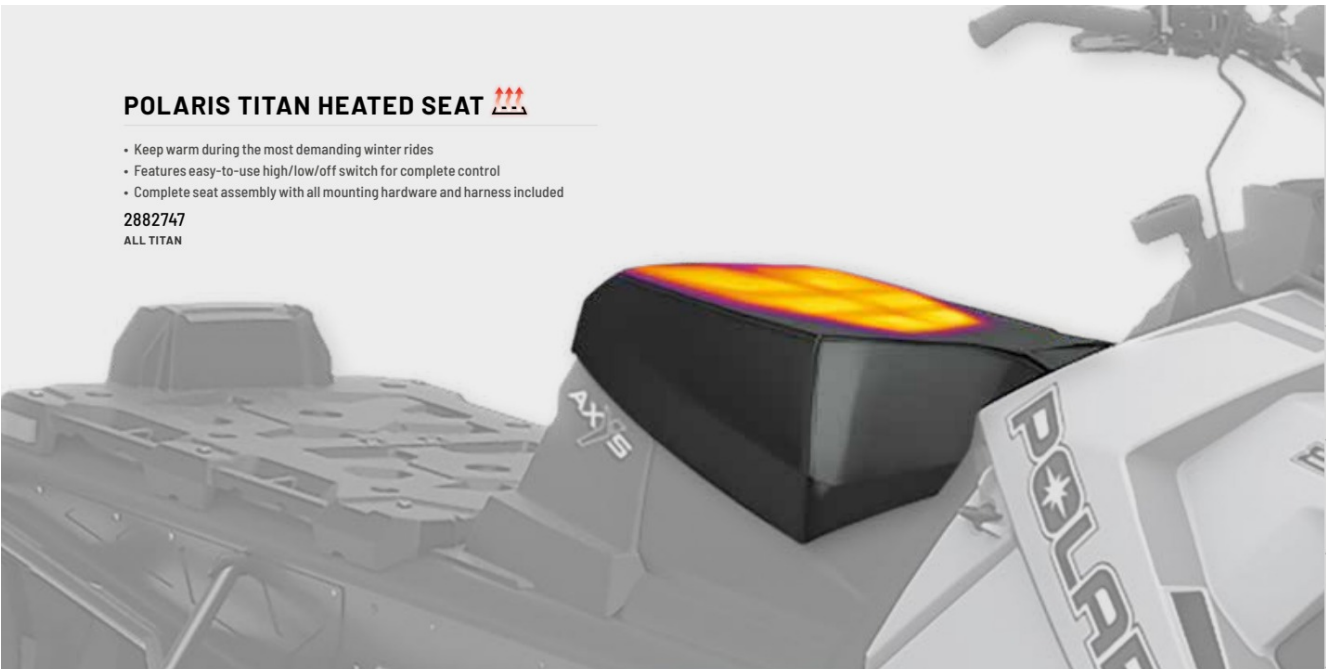

## RUNNING BOARD CLOSE-OUT PLATES

- Aids in water and slush protection when riding in wet conditions
- Premium polyethylene design delivers lightweight protection

2882810  
ALL TITAN



## TITAN REAR BUMPER HANDLES

- Convenient rear grab points for your TITAN

2882803  
ALL TITAN



## TAILLIGHT GUARD

- Protect the top housing of your taillight from stowed gear or accessories
- Rugged aluminum construction secures directly to the rear cargo platform

2882809  
ALL TITAN

## AXYS - TITAN HITCHES



## 1.25" RECEIVER

2882795  
ALL TITAN



## J-HITCH TITAN SCANDI

- 4-Bolts safety hitch.

B0131  
ALL TITAN  
INDY ADVENTURE 137" 2024  
NORDIC PRO 146"



## BALL HITCH

- Allows customer to use any size ball with 3/4" shank
- Requires 1.25" Receiver (2882795), sold separately
- Ball not included

2882813  
ALL TITAN



## HITCH ADAPTER

- Bolts onto either the J-Hook or Standard Hitch to allow them to be used with 1.25" Receiver installed
- Allows user to change between J-Hook, Standard and Ball Hitch without the use of tools

2882814  
ALL TITAN



# PRO-RIDE

The Pro-Ride platform delivers consistent performance at an unbeatable value. Enhance your ride with our collection of accessories developed for the Pro-Ride platform, including everything you need for optimized storage, comfort and protection.

## RMK

MY24 EVO  
 MY20-23 RMK EVO  
 MY11-15 PRO RMK  
 MY11-15 RMK  
 MY11-15 ASSAULT

## SWITCHBACK

MY24 SPORT  
 MY23 550 SPORT  
 MY11-16 ASSAULT  
 MY10-14 PRO-R  
 MY12-14 ADVENTURE

## RUSH®

MY11-14 RUSH

## INDY

MY23-24 550 SPORT  
 MY19-24 EVO  
 MY13-23 550 LXT/ADVENTURE  
 MY13-22 550 121/144  
 MY13-21 600

## VOYAGEUR

MY24 550  
 MY24 LXT  
 MY24 ADVENTURE  
 MY13-23 550 144/155  
 MY14-16 600

**PRO-RIDE - STORAGE**

**RETROFIT YOUR SLED WITH**



**LOCK & RIDE FLEX ADAPTER KIT**

AXYS PRO-RIDE

- Add Lock & Ride Flex storage to AXYS and Pro-Ride full tunnel sleds

**2884939** ★ TOP SELLER

ALL PRO-RIDE & AXYS SLEDS WITH TUNNEL T-SLOTS, NOT COMPATIBLE WITH LOCK & RIDE FLEX M2 SEAT

LOW  
**10**  
LITERS

TALL  
**15**  
LITERS

**SPORT TUNNEL BAG**

MATRYX AXYS PRO-RIDE



Low | **2884453**  
ALL MATRYX, ALL AXYS & PRO-RIDE 121 AND LONGER WITH FULL TUNNEL AND LOCK & RIDE FLEX ADAPTER KIT

Liner Bag - Small | **2889260**

Tall | **2884454**  
ALL MATRYX, ALL AXYS & PRO-RIDE 121 AND LONGER WITH FULL TUNNEL AND LOCK & RIDE FLEX ADAPTER KIT

Liner Bag - Large | **2889261**

**10-15**  
LITERS

**WATERPROOF ROLL TOP BAG**

MATRYX AXYS PRO-RIDE



- Our highest level of moisture resistance, built to protect your valuables
- Roll top design allows for quick and easy access

**2890008**

ALL MATRYX, ALL AXYS & PRO-RIDE 121 AND LONGER WITH FULL TUNNEL AND LOCK & RIDE FLEX ADAPTER KIT

LOW  
**23**  
LITERS

TALL  
**35**  
LITERS

**ADVENTURE TUNNEL BAG**

MATRYX AXYS PRO-RIDE



LOW  
Black | **2884455**  
Liner Bag - Small | **2889262**

**CARBON FIBER COLOR OPTIONS**  
Sky Blue **NEW** 2890622  
Neon **NEW** 2890623

ALL MATRYX, ALL AXYS & PRO-RIDE 128 AND LONGER WITH FULL TUNNEL AND LOCK & RIDE FLEX ADAPTER KIT

TALL  
Black | **2884456** ★ TOP SELLER  
Liner Bag - Large | **2889263**

**CARBON FIBER COLOR OPTIONS**  
Orange Burst **NEW** 2890624  
Neon **NEW** 2890625

ALL MATRYX, ALL AXYS & PRO-RIDE 128 AND LONGER WITH FULL TUNNEL AND LOCK & RIDE FLEX ADAPTER KIT

**9.5**  
LITERS

**EVO TUNNEL STORAGE BAG** PRO-RIDE

- Provides underseat storage for quick access
- Compression-molded design provides rigidity
- Attaches easily with all-weather Velcro® strips

**2883671**

INDY & RMK EVO



**15.2**  
LITERS

**TUNNEL BAG** PRO-RIDE

- Tunnel-top storage provides storage for larger items including clothing and gloves
- Semi-rigid design retains its shape even when empty
- Large zippered opening delivers easy storage access

**2882788**

MY13-20 INDY, MY13-20 INDY SP, MY14-20 INDY ES



## PRO-RIDE - STORAGE

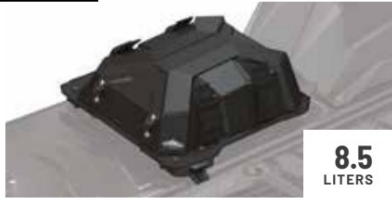

8.5  
LITERS



### BURANDT BAG - MEDIUM

MATRYX AXYS PRO-RIDE

- Compression molded, turtle shell design for enhanced weather resistance
- Oversized buckles provide easy access to gear with your gloves on
- Integrated mounts for spare shovel jacket enabling riders to carry a secondary shovel
- Installation on AXYS and Pro-Ride sleds requires the Lock & Ride Flex Adapter Kit (2884939), sold separately

Black | 2889258 **★ TOP SELLER**

Liner Bag - Medium | 2889349



#### CARBON FIBER COLOR OPTIONS WITH ROLL TOP LINER

Indy Red	2889895
Sky Blue <b>NEW</b>	2890631
Polaris Blue	2889896
Neon <b>NEW</b>	2890632
Radiant Green <b>NEW</b>	2890633



ALL MATRYX, ALL AXYS & PRO-RIDE 128 AND LONGER WITH FULL TUNNEL AND LOCK & RIDE FLEX ADAPTER KIT



15  
LITERS



### BURANDT BAG - LARGE

MATRYX AXYS PRO-RIDE

- Compression molded, turtle shell design for enhanced weather resistance
- Oversized buckles provide easy access to gear with your gloves on
- Integrated mounts for spare shovel jacket enabling riders to carry a secondary shovel
- Installation on AXYS and Pro-Ride sleds requires the Lock & Ride Flex Adapter Kit (2884939), sold separately

Black | 2889259 **★ TOP SELLER**

Liner Bag - Large | 2889350



#### CARBON FIBER COLOR OPTIONS WITH ROLL TOP LINER

Indy Red	2889898
Polaris Blue	2889899
Neon <b>NEW</b>	2890634



ALL MATRYX 155 AND LONGER, ALL AXYS & PRO-RIDE 155 AND LONGER WITH FULL TUNNEL AND LOCK & RIDE FLEX ADAPTER KIT

## SPARE SHOVEL JACKET

MATRYX AXYS PRO-RIDE

Jacket | 2889322 **★ TOP SELLER**

ALL SNOWMOBILES EQUIPPED WITH A LOCK & RIDE FLEX BURANDT BAG

PIEPS® Shovel T 825 Pro  
+ With Saw Blade | 2883680  
ALL SNOWMOBILES



## LOCK & RIDE FLEX ADAPTER KIT

AXYS PRO-RIDE

- Add Lock & Ride Flex storage to AXYS and Pro-Ride full tunnel sleds

2884939 **★ TOP SELLER**

ALL PRO-RIDE & AXYS SLEDS W/ TUNNEL T-SLOTS,  
NOT COMPATIBLE WITH LOCK & RIDE FLEX M2 SEAT



### ADVENTURE RACK WITH SKI/ SNOWBOARD ATTACHMENT

MATRYX AXYS PRO-RIDE

- Get more out of your ride with the versatility of the Adventure Rack
- Add the Ski and Snowboard Attachment to the Adventure Rack for a fully integrated solution. Skiing and snowboarding has never been easier. Catch a ride to the top on your sled and bring all your gear to coast down
- Size medium - fits on tunnel lengths 136" and longer - use with size Small Lock & Ride Flex storage bags on 155" tunnels and longer

**A** Adventure Rack | 2890018

**B** Ski/Snowboard Attachment | 2890017

ALL MATRYX 136 AND LONGER, ALL AXYS & PRO-RIDE 136 AND LONGER WITH FULL TUNNEL AND LOCK & RIDE FLEX ADAPTER KIT



47.5  
LITERS

### ADVENTURE RACK BAG

MATRYX AXYS PRO-RIDE

- Keep your gear dry with water resistant material
- Includes 1 large roll top compartment, and 1 small rolltop compartment
- Adjustable organizer with zipper and pockets; additional zipper pockets throughout the bag.
- Features magnetic Fidlock® buckles for easy and secure use in the cold even with gloves on.
- Adventure Rack (2890018) required, sold separately

2890599

ALL MATRYX 136 AND LONGER, ALL AXYS & PRO-RIDE 136 AND LONGER WITH FULL TUNNEL AND LOCK & RIDE FLEX ADAPTER KIT



6  
LITERS

### ULTIMATE ADVENTURE SADDLE BAG

MATRYX AXYS PRO-RIDE

- Add even more versatility to the Adventure Rack (2890018) with this saddlebag that can be added to one or both sides of the rack
- Roll top design keeps water out and includes built-in storage pockets to keep smaller items secure
- Features magnetic Fidlock® buckles for easy and secure use in the cold even with gloves on
- Requires the Adventure Rack (2890018), sold separately

2890612

ALL MATRYX 136 AND LONGER, ALL AXYS & PRO-RIDE 136 AND LONGER WITH FULL TUNNEL AND LOCK & RIDE FLEX ADAPTER KIT



## PRO-RIDE - RACKS



### VOYEUR 155" EXTREME REAR RACK PRO-RIDE

- Strong, durable tubular construction
- Easy bolt-on installation

2880275  
550 VOYEUR 18-24 & 550 INDY  
ADVENTURE 155" 18-24

### CARGO RACK 144"

AXYS PRO-RIDE

- Design offers three-level storage with low, medium and high cross bars
- Angled design accommodates tie-down straps to secure cargo

Matte Black | 2881940-458  
ALL AXYS, PRO-RIDE 144

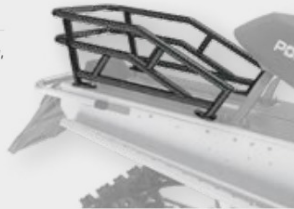

LOCK & RIDE

### REAR RACK BAG PRO-RIDE

- Compression-molded plastic with zippered closure and zippered expansion panel

2878731  
INDY EVO, INDY 17-20



14.4  
LITERS

### HANDLEBAR BAG PRO-RIDE

PRO-RIDE

- Provides quick, convenient access to essential items
- Semi-rigid design retains its shape even when empty
- Attaches easily with all-weather Velcro® strips

2882829  
PRO-RIDE INDY, EVO & VOYEUR



3.9  
LITERS

### CARGO BOX PLASTIC

P261

### CARGO BAG & BOX 144"

AXYS PRO-RIDE

- Semi-compressed with nylon side bag installs securely in cargo rack
- Versatile bag can be converted to a single large-cargo compartment

Cargo box plastic | P294

Cargo bag | 2881968

ALL AXYS, PRO-RIDE 144

REQUIRES CARGO RACK 144"

(2881940-458), SOLD SEPARATELY



42  
LITERS



ACCESSORIES

LOCK & RIDE  
FLEX

COVERS

POLARIS  
PARTNERS

CONNECTED  
TECHNOLOGY

MATRIX

AXYS

PRO-RIDE

RIDE  
READINESS

COLOR  
CUSTOMIZATION

TRANSPORT

TRACTION  
& CONTROL

TRACKS

## PRO-RIDE - WINDSHIELDS

20"  
TALL

### WIDE WINDSHIELD PRO-RIDE

✕ Clear 2878512

ALL PRO-RIDE



7"  
TALL



### LOW WINDSHIELD PRO-RIDE

■ Black 2878779  
□ White 2879097

ALL PRO-RIDE

14"  
TALL



### MID WINDSHIELD PRO-RIDE

■ Smoke 2877841  
■ Matte Black 2879828  
□ White Gloss 2879829

ALL PRO-RIDE

24"  
TALL

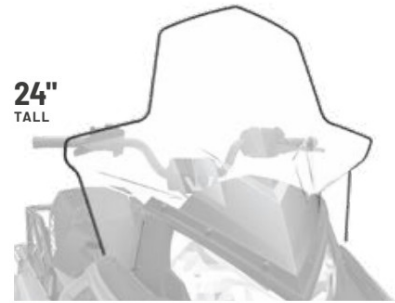

### EXTRA-WIDE TALL WINDSHIELD PRO-RIDE

✕ Clear 2879156

ALL PRO-RIDE

## PRO-RIDE - PROTECTION

### ULTIMATE FRONT BUMPER

PRO-RIDE

■ Raw 2879727  
□ Bright White 2879727-133  
■ Indy Red 2879727-293  
■ Matte Black 2879727-458

ALL PRO-RIDE



## PRO-RIDE - EVO UPGRADE KITS

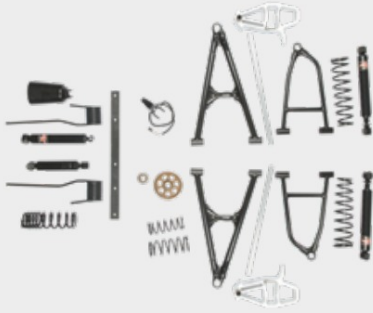

### INDY EVO UPGRADE KIT PRO-RIDE

- Comes with everything you need to evolve your INDY EVO as the rider's skill increases
- Includes tie rods, control arms, spindles, shocks and more
- Convert into a full-speed sled

2883939

INDY EVO MY20-21

INDY EVO MY22-24: SHOCKS IN KIT COME STOCK ON SLED

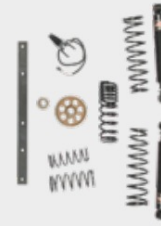

### RMK EVO UPGRADE KIT PRO-RIDE

- Comes with everything you need to evolve your RMK EVO as the rider's skill increases
- Includes IFS shocks, springs and all the parts needed for full power conversion
- Convert into a full-speed sled

2884251

RMK EVO MY20-21

RMK EVO MY22-24: SHOCKS IN KIT COME STOCK ON SLED

## PRO-RIDE - RIDER COMFORT & PASSENGER SEATING



### HOOD MOUNT MIRRORS PRO-RIDE

- Wide-angle view
- Non-fogging glass
- Folding design for use with cover
- Includes mounting hardware
- Sold as a pair

2877803

ALL PRO-RIDE



### KNEE PADS PRO-RIDE

- Set of two

2878195

ALL PRO-RIDE



ACCESSORIES

LOCK & RIDE  
FLEX

COVERS

POLARIS  
PARTNERS

CONNECTED  
TECHNOLOGY

MATRIX

AXIS

PRO-RIDE

RIDE  
READINESS

COLOR  
CUSTOMIZATION

TRANSPORT

TRACTION  
& CONTROL

TRACKS

## RIDE READINESS



Always be ready for the ride. Stay connected and know where you're headed with our technology and electronics offerings. Don't leave without the tools you need for unexpected trailside repairs, and stay confident when faced with sub-optimal riding conditions.

## POLARIS RIDECOMMAND

SEE P. 70 FOR  
MORE DETAILS

### 7S DISPLAY **MATRYX**

2884971  
ALL MATRYX, REQUIRES 7S DISPLAY INSTALL KIT (2884972), SOLD SEPARATELY

### 7S DISPLAY INSTALL KIT **MATRYX**

• Required for 7S Display installation  
2884972  
ALL MATRYX



## BATTERY (REQUIRED FOR ELECTRIC START KITS)

• Sealed, Non-Spill  
4013045: YTX20  
E04999: ETX20  
ALL MATRYX, AXYS, PRO-RIDE



## KEY-OPERATED ELECTRIC START KIT

**MATRYX** **AXYS** **PRO-RIDE**

• Easier to use and more convenient than pull starts  
• Ideal for extreme cold conditions  
• Battery required and not included

2881243

ALL AXYS PRO-RMK, SKS,  
AXYS RMK ASSAULT

2880396

ALL AXYS RUSH, SWITCHBACK

2883931

ALL AXYS 850 PRO-RMK

2883849

ALL AXYS 850 RUSH, INDY XC, SBA

2879330

ALL PRO-RIDE

2879833

VOYAGEUR 550, INDY 550

2884955

ALL MATRYX 129, 137, AND SBA 146

2889361

ALL MATRYX RMK (NON-BOOST)

2889362

MATRYX RMK BOOST

2884776

ALL 800 MY20-21 AXYS  
SWITCHBACK, MY 20 RUSH

2884777

ALL 800 MY20 AXYS RMK

2890511

ALL MATRYX 9R

2890130

MATRYX VR1 & SBA BOOST



## TETHER SWITCH

• Shuts off vehicle if you're separated from the pod  
• Easy to install, mounts directly on pod, connects to pre-wired harness

2874379 **★ TOP SELLER**

ALL SNOWMOBILES

2883823

ALL 850 SNOWMOBILES



## MAGNETIC TETHER

• Shuts off vehicle if you're separated from it  
• Magnetic engagement enhances connection and retention  
• Easy to install: mounts directly to console via a pre-wired harness

2889143

ALL 800/800 SNOWMOBILES

2889142 **★ TOP SELLER**

ALL 850/850 SNOWMOBILES



RCA ADAPTER

## 12 VOLT/RCA PLUGS

• 12v accessory plugs into 12v outlet, great for GPS or phone, dash mount  
• RCA adapter allows you to plug in a heated face shield or vest  
• RCA power plug includes all hardware required to add an RCA outlet  
• Includes splitter to use with Auxiliary Lighting, see P. 78 for lighting

RCA Power Plug | 2883824 **★ TOP SELLER**

ALL 650, 850, S4

RCA Adapter | 2878227

ALL AXYS, ALL PRO-RIDE

RCA Power Plug | 2878780 **★ TOP SELLER**

ALL AXYS, PRO-RIDE, AND TITAN

12v | 2878475

ALL AXYS, ALL PRO-RIDE

12v | 2890259 **★ TOP SELLER**

ALL MATRYX

**CRUZTOOLS®**



ACCESSORIES

LOCK & RIDE  
FLEX

COVERS

POLARIS  
PARTNERS

CONNECTED  
TECHNOLOGY

MATRYX

AXYS

PRO-RIDE

RISE  
READINESS

COLOR  
CUSTOMIZATION

TRANSPORT

TRACTION  
& CONTROL

TRACKS



**NEW CRUZ TOOLS KIT**

- Tool kit consists of all the tools you'll need for most trailside repairs
- Multiple types of tools ranging from wrenches, ratchets, pliers and zip ties
- Comes with tool roll to hold all the tools in one easy to carry place

Tool kit | **2889416**  
Tool pouch | **2889417**  
ALL SNOWMOBILES



**NEW REVERSIBLE ICE SCRATCHERS** **MATRYX** **AXYS**

- Maintains optimum track and engine temperature in a wider variety of snow conditions delivering an enhanced riding experience
- Single coil design for increased durability on the trail
- Fully reversible scratchers for added durability and convenience

**2890644**  
2011-2024 RMK MODELS  
STANDARD ON MY24 RMK MODELS

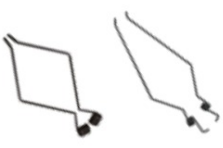

**ICE SCRATCHERS** **AXYS** **PRO-RIDE**

- Direct ice chips into skid to lube and cool hi-fax
- 2882028**  
AXYS PRO-RMK, ASSAULT RMK, SKS 155  
**2876256**  
ALL PRO-RIDE RMK



**RMK BOGIE WHEEL KIT** **AXYS** **PRO-RIDE**

- Wheels install on stock skid
  - Reduces hi-fax wear on hard-pack snow and ice
  - A total of three pairs can be installed onto a stock skid
- 2882048**  
ALL AXYS RMK  
**2878251**  
ALL PRO-RIDE RMK



**VESPEL® HYFAX** **MATRYX** **AXYS** **PRO-RIDE**

- Long lasting VespeL® Hyfax allows for more miles compared to standard extruded plastic option hyfax
  - Made from stronger compound than the plastic option
- 2889115**  
ALL SNOWMOBILES 120-146



**RMK REACT FRONT SUSPENSION KIT** **AXYS**

- Comes with everything you need to convert your AXYS PRO-RMK to a 36" wide front end
  - Includes shocks, upper and lower control arms, tie rods, sway bar and all hardware
- 2883686-309**  
ALL AXYS RMK  
STANDARD ON MY19 & NEWER PRO RMK & RMK KHAOS MODELS

FOR ADDITIONAL SHOCKS VISIT  
**POLARIS.COM/SUSPENSION**

## HITCHES

# J-HITCH

- J-Hitch can be mounted on all snowmobile units from MY 1988-2023.
- Mounts for each model of snowmobile are listed under.
- Available in black color.
- More mounts can be purchased just contact your local dealer for hitch to your model of snowmobile.

B0221



### Kit-Mount and J-Hitch 2024

- B0131** J-Hitch TITAN Safety, 4-Bolt
- B0221** J- Hitch | MY 1989-2024 Black
- B0256** K-Mount 600/850 INDY XC137" | MY 20-24
- B0256** K-Mount 650/ 850 VR1/ INDY XC 137" MATRYX MY 2021-24
- B0256** K-Mount 650/ 850 XCR 136" MATRYX MY 21-24
- B0254** K-Mount 650/ 850 Switchback 146" MATRYX MY 21-24
- STD** PROSTAR 4S Indy Adventure 137"
- STD** S4 Nordic PRO /650 Nordic PRO 146"
- STD** PROSTAR 4S Titan Adventure 155"

### Kit-Mount Older Snowmobiles.

- B0221** J- Hitch | MY 1989-2024 Black
- B0130** J-Hitch Widetrack GT/ LX/ IQ
- B0255** K-Mount 600/800 INDY XC 129" | MY 2019 - 2020
- B0255** K-Mount 650/ 850 VR1/ INDY XC 129" MATRYX -22
- B0251** K-Mount AXYS RMK & SKS 155" | MY 16-21
- B0254** K-Mount AXYS SKS 146" 600/800 Switchback Assault 144" and 800 Switchback SP 144" | MY -2019
- B0254** K-Mount 850 Switchback Boost 146" 2023
- B0252** K-Mount AXYS SWB Assault/ SP 144", SKS 146" | MY -18
- B0246** K-Mount RMK 155" | MY 12-15
- B0248** K-Mount INDY Voyageur 550 14, 550 Adventure X2 | MY 14-16
- B0245** K-Mount 600 INDY VOYAGER | MY 14 - 16
- B0236** K-Mount IQ 121" 08-2012, IQ SWB 136" | MY 08-10
- B0245** K-Mount Switchback 144" | MY 11-15
- B0244** K-Mount INDY 121", INDY EVO | MY 19-20
- B0236** K-Mount 550IQ LXT Touring | MY 11-13
- B0249** K-Mount 550 INDY VOYAGER | MY 15-16
- B0249** K-Mount 550 INDY Adventure | MY 15-16



## ÖHLINS® HIGH PERFORMANCE SHOCKS

- P-Type Shocks with springs included. Fully re-buildable.
- Adjustable compression and rebound adjuster.
- SWB shocks are updated for 2019 models.
- High performance
- Öhlins shocks are always updated for the newest model years.

PB610 | FRONT PRO RMK 36" KHAOS (PAIR), 0-ADJUST 19-24  
MN011 | CENTER 36PC, RMK KHAOS 20-24  
PB609 | REAR RMK/SKS 17-21, KHAOS 20-24





At Cobra Cords we are focused on creating high performance pull start cords. Our products utilize fiber, braiding and coating technologies to create a pull cord that is engineered to last. Cobra Cords are 100% lifetime guaranteed.

### SNOWMOBILE COBRA® CORD

Black	2889918
Red	2889919
Blue	2889920
Purple	2889921
Pink	2889922

ALL SNOWMOBILES



Give your sled a custom-finished look with factory-color-matched skis, ski toes and spindles. The combinations are endless.



\* TOP SELLER

### GRIPPER SKI

MATRYX AXYS PRO-RIDE

- Deep 1.5" keel provides positive steering in deep, loose mountain snow
- Wide 6.75" ski delivers increased flotation
- Top traction surface for boot stepping on ski
- Includes black ski toe and hardware
- Requires carbide skags, sold separately
- Black comes standard on all RMK models
- Sold individually

Black	2877679-070
Indy Red	2877679-293
White	2877679-570

ALL SNOWMOBILES



### PRO-FLOAT SKI

MATRYX AXYS PRO-RIDE

- Adapted, 9.5" wide Pro-Steer ski design provides 45% more flotation for off-trail deep-snow performance
- Includes black ski toe
- Sold individually

Black	2880482
-------	---------

ALL SNOWMOBILES



### PRO-STEER SKI

MATRYX AXYS PRO-RIDE

- Engineered keel design and shortened skag perfect for the trail
- Supportive ribs for torsional stiffness
- No-slip traction atop ski
- Alternate ski stop may be required
- Includes black ski toe and hardware
- Black comes standard on all TP/CO models
- Sold individually
- Carbide skags required, sold separately

Black	2885164-070
Bright White	2885164-133
Indy Red	2885164-293

ALL SNOWMOBILES

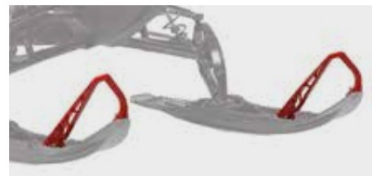

### SKI TOE

Black	2889421-070
White	2889421-133
Indy Red	2889421-293
Orange Burst	2889421-647
Sky Blue	2889421-737
Plum Crazy	2889421-784
Polaris Blue (Non-Metallic)	2889421-795
Stealth Gray	2889421-804

ALL POLARIS SKIS



### SPINDLES

- Strong, lightweight aluminum construction with same tolerances as stock spindles
- Exact replacement for stock spindles

RUSH/SWITCHBACK FITMENT: ALL AXYS 120 - 144 SNOWMOBILES  
FORGED RMK FITMENT: ALL AXYS RMK



### RUSH/SWITCHBACK FORGED RMK

Gloss Black	--	2884205-067
Indy Red	--	2884205-293
Matte Black	2881409-458	--
Orange Burst	--	2884205-647

## TRANSPORT

### ★ TOP SELLER

2882998	TraxGrabber
2882970	72" TraxMat
2882967	Grips (set of 6)
2882979	LowPro Glide - Standard 9" Double Set - 16pc. (40' Kit)
2882983	LowPro GripGlide - Standard 9" Double Set - 16pc. (40' Kit)
2882984	Flex Glides Low Profile (set of 8)
2882985	Flex Glides High Profile (set of 8)
2884383	EdgeGuard - 12pc. Kit
2884382	Edge Glide 2.0 - 4pc. Kit (96")
2882989	Poly Shield Series III
2882990	V-Front Ramp Shield Disco
2883004	Retrax - Self-Retracting Strap Set

POLARIS PART NUMBERS UTILIZED IN CHART ABOVE. ONLY TOP SELLERS PROVIDED, FULL PRODUCT LINE DETAIL IS AVAILABLE IN THE CONFIGURATOR.

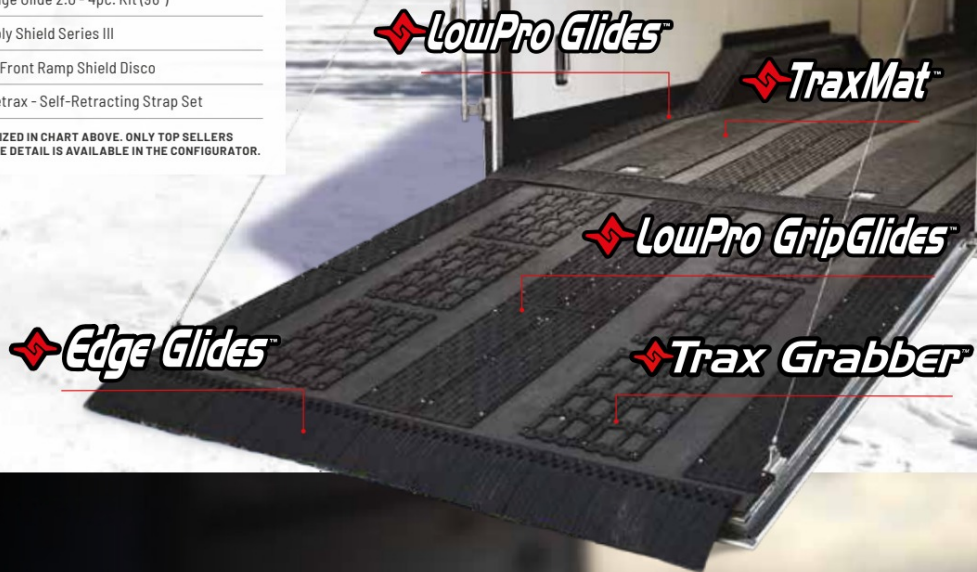

## CUSTOMIZE YOUR TRAILER WITH THE POLARIS ONLINE CONFIGURATOR

Fully customize your trailer using the Polaris online configurator. Select from the full range of Caliber® trailer products and when finished print a detailed parts list based on your selections.

VISIT [POLARIS.COM/TRAILERING](http://POLARIS.COM/TRAILERING)







## SLED WHEELS

- New improved polymer
- Provides amazing mobility for snowmobiles
- Universal modular design works with most snowmobile skis
- Innovative design provides fast engagement and disengagement

Carbon Black | 2883853



## RAMP PRO 2.0

### 1,500 POUND RATING

- Innovative ramp design for snowmobiles, ATVs, UTVs and golf carts
- Improved 2.0 design features 12" wide glides accommodating narrow RMK ski stances

2884576 **★ IMPROVED DESIGN**  
ALL SNOWMOBILES



Ramp Grips | 2882968

#### TRACTION AND GLIDE



#### INTEGRATED FINGERS



#### INTEGRATED FEET



Integrated Self-Retracting Strap Included

## TRAX WHEELS 2.0

### 500 POUND RATING

- Tapered sides allow track to easily drop in place
- Specifically designed to accommodate all track pitches: 2.52", 2.86" and 3.0"
- Over-sized 5" urethane casters make moving over rough surfaces a breeze

2884384

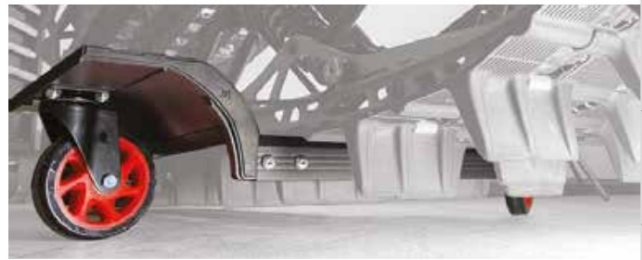

## FRONT CLAMP

- Adjustable to fit all snowmobiles
- Rubber silicone pads protect and secure skis
- Integrates to all trailers
- Includes deck hook

2882961

ALL SNOWMOBILES



## REAR CLAMP

- Composite construction with silicone rubber padding
- Tension adjustment knob to fit all snowmobiles
- Secures via rear suspension skid
- 12" Supertrac Kit included

2882962



## SUPERCLAMP® DECK HOOK

2882963



## SUPERCLAMP® TRAC HOOK

2882965



## SUPERCLAMP® TRAC

• 12" length  
2882964

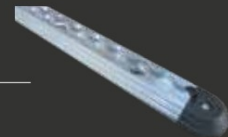

ACCESSORIES

LOCK & HIDE  
FLEX

COVERS

POLARIS  
PARTNERS

CONNECTED  
TECHNOLOGY

MATRIX

AXIS

PRO-RIDE

RISE  
READINESS

COLOR  
CUSTOMIZATION

TRANSPORT

TRACTION  
& CONTROL

TRACKS

## TRACTION & CONTROL

# RIP WITH AN IRON GRIP

Whether you're replacing your carbides or looking to add more traction and control for enhanced safety and performance, premium Woody's® stud kits and carbide runners are exclusively engineered for your Polaris snowmobile.

## CONTROL FOR HOW YOU RIDE

### TUNNEL PROTECTION

Required protection for when you stud, these "wear strips" protect your tunnel and vital cooling components from damage.

### CARBIDES

Replacing or upgrading, add the right amount of ski control to match your track length, studding pattern and riding style.

### STUDS

Choose the right length stud for your track lug and then select a pattern to best suit your riding style for a touch of added control to monster holeshots.

### TUNNEL PROTECTION

SLED MODEL	FITMENT	PART NUMBER
AXYS Indy 129 SP, 129 XC, Indy XCR	MY19-22	2883572
Titan	MY18-24	2882880
AXYS Switchback Assault	MY17-21	2884730
Pro-Ride Switchback Assault	MY11-16	2878161
Pro-Ride 550 Indy 144, Voyageur 144	MY11-24	2879831
550 Indy 121	MY11-24	2879830
Pro-Ride 600/800 Indy 121	MY13-20	2879212
AXYS Indy 137 SP, Indy 137 XC, Indy 137 Adventure	MY20-22	2884301
Indy Evo	MY11-24	2879830
MATRYX 128/129 <b>★ TOP SELLER</b>	MY21-24	2884961
MATRYX 137 <b>★ TOP SELLER</b>	MY21-24	2884962
MATRYX 146 <b>★ TOP SELLER</b>	MY21-24	2884963

### CARBIDE WEAR STRIPS

Carbides need to be sharpened or replaced periodically due to normal wear and use. Rocks, cement, pavement and road crossings all contribute to carbide wear.

#### 3"-4" CARBIDE



Perfect for sleds with a 121" track with 96 studs or less or sleds with 1" lugs taking corners at moderate speeds

#### CHOOSE YOUR LENGTH

#### 6" CARBIDE

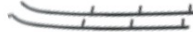

Ideal for sleds in the 136" track range with up to 1 1/4" lugs or shorter track sleds with more than 96 studs

#### 8" CARBIDE



Best for ultimate-performance sleds with a 144" track or longer with paddles and/or the maximum amount of studs



### SINGLE RUNNER

Provides known reliability, handling and control.

SKI	NOTE	3"	4"	6"	6"	8"	8"
Pro-Steer/Pro-Float	Sold in Pack of 2	--	2879025 <b>★ TOP SELLER</b>	--	2879026 <b>★ TOP SELLER</b>	--	2879027
Gripper	Sold in Pack of 2	2875723 <b>★ TOP SELLER</b>	--	2877880	--	2877881	--

### DOUBLE RUNNER

Provides an increase in steering control in icy conditions and minimizes darting when riding on packed trails. Perfect to pair with a studded track.

SKI	NOTE	SLIM JIM		DOOLY	
		4"	6"	4"	6"
Pro-Steer/Pro-Float	Sold Individually	2882956	2882957	2882953	2882954



## STUD KITS

Includes everything to update your sled's traction—Gold Digger® studs, nuts, backer plates, template and track drill bit.



ENGINE	TRACK	TRACK LENGTH	LUG HEIGHT	PITCH	STUD QUANTITY	STUD KIT
600/650	1.5" Storm	137	1.5	2.86	GMP-1575: 96	2890458
800/850	1.5" Storm	137	1.5	2.86	GMP-1575: 144	2890459
650	1.6" Cobra	128	1.6	2.52	GMP-1575: 102	2890460
850	1.6" Cobra	128	1.6	2.52	GMP-1575: 153	2890461
650/S4	1.5" Ice Storm/1.6" Cobra	146	1.5/1.6	2.86	GMP-1575: 102	2890462
850	1.5" Ice Storm/1.6" Cobra	146	1.5/1.6	2.86	GMP-1575: 153	2890463
650	1.6" Cobra	136	1.6	2.52	GMP-1575: 108	2890464
850	1.6" Cobra	136	1.6	2.52	GMP-1575: 162	2890465
650	1.5" Storm	129	1.5	2.86	GMP-1575: 90	2890466
850	1.5" Storm	129	1.5	2.86	GMP-1575: 135	2890467
600	1.6" Cobra	144	1.6	2.52	GMP-1575: 114	2890468
550	1.6" Cobra	155	1.6	2.86	GMP-1575: 108	2890469
800/S4	1.5" Cobra	155	1.5	2.86	GMP-1575: 108	2890470
600/650	1.25" Ice Ripper XT 1.352" Cobra	128	1.25/1.352	2.52	GDP6-1325: 102	2890471
800/850	1.25" Ice Ripper XT 1.352" Cobra	128	1.25/1.352	2.52	GDP6-1325: 153	2890472
600/650/S4	1.25" Ice Ripper 1.352" Cobra 1.25" Ice Ripper XT 1.22" Ice Attak XT 1.25" Ripsaw II	129	1.25/1.352	2.86	GDP6-1325: 90	2890473
800/850	1.25" Ice Ripper 1.352" Cobra 1.352" Cobra R 1.25" Ice Ripper XT 1.25" Ripsaw II	129	1.25/1.352	2.86	GDP6-1325: 135	2890474
600/650	1.25" Ice Ripper 1.352" Cobra	136	1.25/1.352	2.52	GDP6-1325: 108	2890475
800/850	1.25" Ice Ripper 1.352" Cobra 1.22" Ice Attak XT 1.25" Ripsaw II	136	1.25/1.352	2.52	GDP6-1325: 162	2890476
600/650/S4	1.25" Ice Ripper 1.352" Cobra 1.25" Ice Ripper XT 1.25" Ripsaw II	137	1.25/1.352	2.86	GDP6-1325: 96	2890477
800/850/BOOST	1.25" Ice Ripper 1.352" Cobra 1.352" Cobra R 1.25" Ice Ripper XT 1.25" Ripsaw II	137	1.25/1.352	2.86	GDP6-1325: 144	2890478
550/600	1.352" Cobra	144	1.352	2.52	GDP6-1325: 114	2890479
650/S4	1.352" Cobra	146	1.352	2.86	GDP6-1325: 102	2890480
850/BOOST	1.352" Cobra	146	1.352	2.86	GDP6-1325: 153	2890481
S4	1" Ripsaw II	129	1	2.86	GDP6-1075: 90	2890482
BOOST	1" Ripsaw II R	129	1	2.86	GDP6-1075: 135	2890483
S4	1" Ripsaw II	137	1	2.86	GDP6-1075: 96	2890484
BOOST	1" Ripsaw II R	137	1	2.86	GDP6-1075: 144	2890485
550	1" Energy	144	1	2.52	GDP6-1075: 114	2890486
800	1.5" Cobra	155	1.5	2.86	GDP6-1575: 108	2890487
800	1.375" Ripsaw	155	1.375	2.86	GDP6-1450: 108	2890488
800	1.5" Cobra	155	1.5	2.86	GMP-1575: 108	2890489

**TRACKS**

# FOUR KEYS TO TRACK SELECTION



## LENGTH

The inside circumference of the track is calculated as the drive pitch multiplied by the number of track segments. It must be correct to the nearest inch for proper fit without additional modifications to the skid frame.

## DRIVE PITCH

The drive cog center distance around the circumference of the cogs on the drive axle. It must match the existing track or the drive cogs must be changed.

## WIDTH

The measurement across the track governed by the width of the tunnel.

## LUG HEIGHT

The distance lugs extend above the track surface.

- Trail: 1" - <1.5"
- On/Off Trail: 1.5" - <2"
- Deep Snow: 2" and greater

SEE ALL TRACKS OPTIONS AT [POLARIS.COM/TRACKS](http://POLARIS.COM/TRACKS)

LUG HEIGHT

DRIVE PITCH



## TRAIL



### ICE STORM 150

ON TRAIL OFF TRAIL

- Two-height lug design offers deep-snow flotation with handlebar-gripping acceleration
- Factory-pre-studded for improved traction and control on icy conditions
- 1.25" outer lugs and 1.5" cup-shaped center lugs provide power and traction on packed trails and turns

LENGTH	PITCH	LUG HEIGHT	
120"	2.86"	1.25"	<b>2839388</b>
129"	2.86"	1.25"	<b>2839389</b>
137"	2.86"	1.25"	<b>2839390</b>
146"	2.86"	1.25"	<b>2839391</b>



### HURRICANE

ON TRAIL OFF TRAIL

- Designed based on mountain tracks, it provides off-trail performance in deep snow while maintaining on-trail agility
- 1.75" cupped profile design provides unparalleled grip in the backcountry
- 1.75" tall lug profile design reduces vibration, applying more power to the ground

LENGTH	PITCH	LUG HEIGHT	
120"	2.86"	1.75"	<b>2839400</b>
129"	2.86"	1.75"	<b>2839401</b>
137"	2.86"	1.75"	<b>2839402</b>
146"	2.86"	1.75"	<b>2839403</b>



### COBRA

ON TRAIL OFF TRAIL

- Cupped lugs for superior acceleration and braking in loose, soft-snow conditions
- Flexible lug design for superior off-trail performance

LENGTH	PITCH	LUG HEIGHT	
120"	2.86"	1.352"	<b>2839284</b>
121"	2.52"	1.352"	<b>2839052</b>
129"	2.86"	1.352"	<b>2839235</b>
136"	2.52"	1.352"	<b>2839061</b>
137"	2.86"	1.352"	<b>2839307</b>
137"	2.86"	1.352"	<b>5413661</b>
144"	2.52"	1.352"	<b>2839107</b>
144"	2.86"	2.52"	<b>5414013</b>
144"	2.86"	1.6"	<b>5416162</b>
155"	2.86"	1.5"	<b>5415826</b>
155"	2.86"	1.8"	<b>5416020</b>
136"	2.52"	1.352"	<b>5413655</b>
128"	2.52"	1.352"	<b>5416296</b>
129"	2.86"	1.352"	<b>5416604</b>



### ICE RIPPER



- Factory pre-studded for improved traction and control
- 1.25" lug height for improved traction and stability
- RipSaw-based attack angled lugs for excellent forward and lateral bite

LENGTH	PITCH	LUG HEIGHT	
137"	2.86"	1.25"	<b>5416995</b>



### HACKSAW



- 1" lug height for low rolling resistance that improves fuel economy
- Crescent lug features recessed tips and cutting edges for forward and lateral bite on hard-pack
- Hard-wearing rigid lugs for mile after mile of dependable use
- Narrow lug base to reduce rolling resistance and maximize top speed

LENGTH	PITCH	LUG HEIGHT	
121"	2.52"	1"	<b>5413198</b>
136"	2.52"	1"	<b>5413318</b>



### ICE ATTAK XT



- Factory-pre-studded for improved traction and control
- Designed to provide even better ice performance than the ICE Ripper XT
- 1.22" lug height provides better handling and stability
- Optimized rubber compound for superior traction on groomed trail

LENGTH	PITCH	LUG HEIGHT	
120"	2.86"	1.22"	<b>2839190</b>
121"	2.52"	1.22"	<b>2839200</b>
128"	2.52"	1.22"	<b>2839201</b>
129"	2.86"	1.22"	<b>2839236</b>
136"	2.86"	1.22"	<b>2839202</b>
137"	2.86"	1.22"	<b>2839191</b>
144"	2.52"	1.22"	<b>2839203</b>



### STORM 150



- 1.25" outer lugs provide power through the tightest turns with ease, maintaining momentum and rider control
- 1.5" cup-shaped center lugs provide deep snow flotation and gut-wrenching acceleration on packed trails
- Optimized support columns provide the right balance of lug rigidity and flex for performance across the entire power band

LENGTH	PITCH	LUG HEIGHT	
120"	2.86"	1.25/1.5"	<b>2839368</b>
129"	2.86"	1.25/1.5"	<b>2839369</b>
137"	2.86"	1.25/1.5"	<b>2839370</b>
146"	2.86"	1.25/1.5"	<b>2839371</b>
137"	2.86"	1.25/1.5"	<b>5416618</b>
129"	2.86"	1.25/1.5"	<b>5416605</b>



### RIPSAW



- Rigid lugs provide superior handling, acceleration and braking on groomed trails
- Narrow lug base for reduced rolling resistance and maximum top speed
- Angled profiles for aggressive forward and lateral bite

LENGTH	PITCH	LUG HEIGHT	
136"	2.52"	1.5"	<b>2877648</b>
120"	2.86"	1.25"	<b>2839149</b>
121"	2.52"	1.25"	<b>2839968</b>
128"	2.52"	1.25"	<b>2839215</b>
136"	2.52"	1.25"	<b>2839969</b>
155"	2.86"	1.375"	<b>5416227</b>



### RIPSAW 2



- Tapered outside lug edges for less side bite when cornering
- Sharp angled lugs for excellent bite on hard-pack snow
- Cupped center and full outer lugs for traction on loose, less-compacted snow

LENGTH	PITCH	LUG HEIGHT	
120"	2.86"	1.25"	<b>2839209</b>
120"	2.86"	1.25"	<b>5414653</b>
121"	2.52"	1.25"	<b>2839214</b>
129"	2.86"	1.5"	<b>2839305</b>
136"	2.52"	1.25"	<b>2839216</b>
137"	2.86"	1.5"	<b>2839306</b>
137"	2.86"	1.25"	<b>5414654</b>
129"	2.86"	1.25"	<b>5416585</b>

# TRACKS

## MOUNTAIN



### NEW SERIES 9

ON TRAIL OFF TRAIL

- All new 3.5" pitch track with 3.25" tall lugs for deep snow riding
- Spools up quickly and puts the power down to the snow
- Features an aggressive Polaris-exclusive lug design for instant traction and forward drive in deep snow
- Fits only with MY24 Dual Extrovert Driveshaft

LENGTH	PITCH	LUG HEIGHT	
155"	3.5"	3.25"	5418540
165"	3.5"	3.25"	5418541



### SERIES 8

ON TRAIL OFF TRAIL

- Lightweight 3.5" pitch track with 2.75" lugs optimized flex and improved stiffness
- Reduces mass and lowers inertia resulting in instantaneous lift, superior traction and optimum flotation for all types of mountain riding
- Fits the New Dual Extrovert Driveshaft\*

LENGTH	PITCH	LUG HEIGHT	
155"	3.5"	2.75"	5415140
155"	3.5"	2.75"	5418047*
165"	3.5"	2.75"	5416387*
165"	3.5"	2.75"	5418048



### SERIES 7

ON TRAIL OFF TRAIL

- Polaris exclusive
- Ideal track to provide lift in the deepest, softest snow conditions
- Features a new lightweight single-ply design optimized for weight and powder snow performance

LENGTH	PITCH	LUG HEIGHT	
155"	3"	3"	5415393
163"	3"	3"	5415394
174"	3"	3"	5415786



### SERIES 6

ON TRAIL OFF TRAIL

- Outstanding traction and control in deep snow
- Lugs provide tremendous flotation and great performance
- 2.6" lugs provide outstanding traction in all deep-snow conditions
- Design provides outstanding flotation and control

LENGTH	PITCH	LUG HEIGHT	
155"	2.86"	2.6"	5415391
163"	2.86"	2.6"	5415392
155"	2.86"	2.6"	5416838

## MOUNTAIN



### SERIES 5.2

ON TRAIL OFF TRAIL

- Modeled after the modified Series 5.1 track used by Polaris hill climb racers
- Provides great traction both on- and off-trail
- Maintains excellent durability
- Optimized lug pattern for more forward lug contact

LENGTH	PITCH	LUG HEIGHT	
146"	2.86"	2.25"	5416498



### SERIES 5.1

ON TRAIL OFF TRAIL

- Industry-leading deep-powder track; for 8T drive sprockets, 2.86" pitch
- Optimized lug pattern producing 19% more forward lug contact compared to our Series 5.0 track
- Soft and flexible tips for superior performance in deep snow

LENGTH	PITCH	LUG HEIGHT	
155"	2.86"	2.4"	5413622
163"	2.86"	2.4"	5413621



### SERIES 4

ON TRAIL OFF TRAIL

- The standard in 2" deep-snow tracks; for 9T drive sprockets, 2.52" pitch
- Equal parts versatility and durability
- Stiff lug base for long wear and hard-pack performance
- Soft and flexible tips for superior performance in deep snow

LENGTH	PITCH	LUG HEIGHT	
144"	2.52"	2"	5413073
144"	2.52"	2"	5415692



### PEAK 2.25

ON TRAIL OFF TRAIL

- Angular lugs bite and funnel snow under the snowmobile for outstanding flotation
- Features soft lugs for powder snow and hard lugs for heavy/wet snow
- Outer lug bars deliver better lateral control for improved handling

LENGTH	PITCH	LUG HEIGHT	
155"	2.86"	2.25"	5415002

## MOUNTAIN



### EPIC

ON TRAIL OFF TRAIL

- Reduced vibration and improved handling in deep snow
- Unique deep cup shaped lug design
- Stiffer columns design improves packed snow grip, riding agility and braking

LENGTH	PITCH	LUG HEIGHT	
162"	3"	2.8"	2839407
156"	3"	2.8"	2839408



### SHOCKWAVE

ON TRAIL OFF TRAIL

- Designed for hard-working, utility applications
- Able to handle heavy workloads in deep-snow, off-trail environments
- Tackles on-trail and hard-packed applications

LENGTH	PITCH	LUG HEIGHT	
156"	2.52"	1"	5414453
121"	2.52"	0.91"	5412281

## MISCELLANEOUS



### COMPETITION TRACK

ON TRAIL OFF TRAIL

- Customized for competition
- Developed for and tested by top Polaris racers

LENGTH	PITCH	LUG HEIGHT	
155"	2.86"	2.1"	2877304



### YOUTH 120

ON TRAIL OFF TRAIL

- Replacement track for the Polaris 120 INDY

LENGTH	PITCH	LUG HEIGHT	
68"	2.55"	.71"	5411751

**CROSSOVER**



**BACKCOUNTRY**

ON TRAIL OFF TRAIL

- Arched lug design with staggered, snocross-inspired pattern for excellent soft-snow traction

LENGTH	PITCH	LUG HEIGHT	
120"	2.86"	1.75"	5414894
121"	2.52"	1.75"	2839140
121"	2.52"	1.75"	5415097
136"	2.52"	1.75"	2839142
136"	2.52"	1.75"	5414378
137"	2.86"	1.75"	5414895
144"	2.52"	1.75"	5415096
144"	2.52"	1.75"	2839143
128"	2.52"	1.75"	5417031

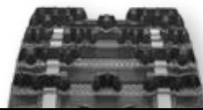

**COBRA 1.6**

ON TRAIL OFF TRAIL

- Cupped lugs for superior acceleration and braking in loose, soft-snow conditions
- Flexible lug design for superior off-trail performance
- Select lugs are more rigid for traction on hard-packed snow

LENGTH	PITCH	LUG HEIGHT	
155"	2.86"	1.6"	5414902



**ICE COBRA 1.6**

ON TRAIL OFF TRAIL

- Cupped lugs for superior acceleration and braking in loose, soft-snow conditions
- Flexible lug design for superior off-trail performance
- Factory-pre-studded with 1.6" lugs for excellent all-round performance, especially on ungroomed trails

LENGTH	PITCH	LUG HEIGHT	
137"	2.86"	1.6"	2839246
155"	2.86"	1.6"	2839273



**CHALLENGER**

ON TRAIL OFF TRAIL

LENGTH	PITCH	LUG HEIGHT	
144"	2.52"	2"	2839875
146"	2.86"	2.5"	2839145
151"	2.52"	2"	2839876
154"	2.86"	2.5"	2839104
162"	3"	2.5"	2839319
163"	2.86"	2.5"	2839105

**CROSSOVER**



**SNOW CROSS**

ON TRAIL OFF TRAIL

- Customized for snocross competition
- Developed for and tested by top Polaris racers

LENGTH	PITCH	LUG HEIGHT	
129"	2.52"	1.75"	5450277



**BACKCOUNTRY X2**

ON TRAIL OFF TRAIL

- Arched lug design with staggered snocross-inspired pattern for excellent soft snow traction
- Rigid lug support columns and optimized rubber compound to deliver great on/off-trail performance
- 2.86" drive pitch

LENGTH	PITCH	LUG HEIGHT	
146"	2.86"	2"	2839417



**ICE COBRA WT**

ON TRAIL OFF TRAIL

- Extra-high 1.5" lugs for the best possible traction
- Cupped lug design ideal in soft, loose snow and for off-trail backcountry exploration
- Lightweight for greater efficiency and improved fuel economy

LENGTH	PITCH	LUG HEIGHT	
155"	2.86"	1.5"	2839414

FITS TITAN MODELS

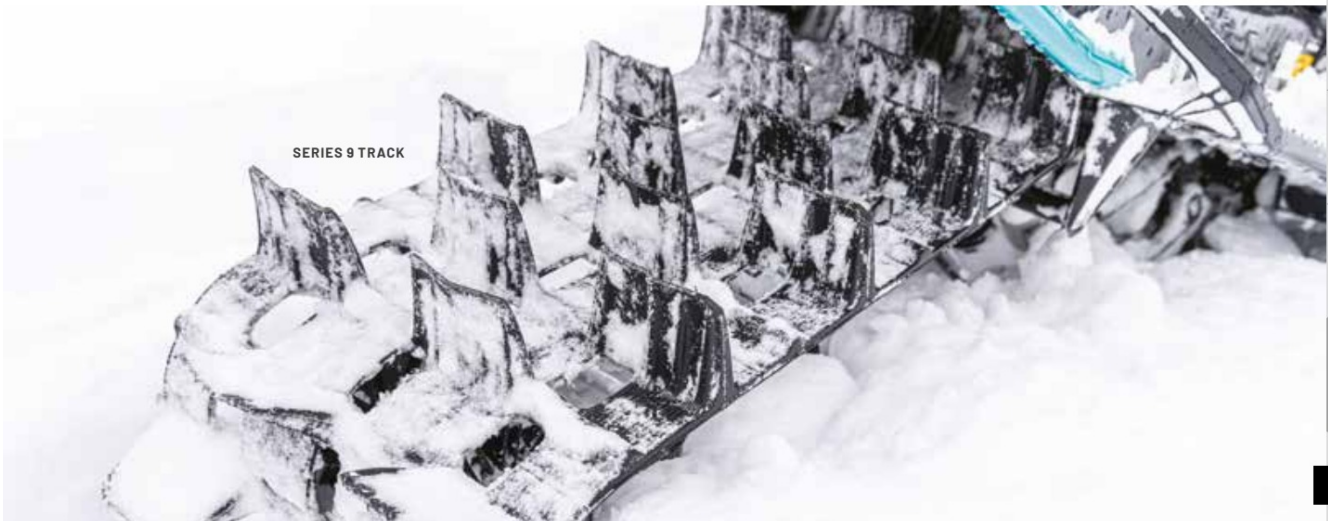

LOCK & RIDE FLEX

COVERS

POLARIS PARTNERS

CONNECTED TECHNOLOGY

MATRIX

AXIS

PRO-RIDE

RIDE READINESS

COLOR CUSTOMIZATION

TRANSPORT

TRACTION & CONTROL

TRACKS

**POLARIS**  
**ENGINEERED**

# GARAGE

## FACTORY APPROVED.

Every Polaris snowmobile has been engineered and manufactured to deliver performance. Keep it that way by using the same lubricants, cleaners and service parts our factory-trained technicians use.

### GARAGE CONTENTS

- 122 Maintenance
- 124 Oil
- 128 Lubricants & Garage Accessories
- 130 Belts, HD Parts & Battery Chargers
- 131 Battery Charger
- 132 Service Parts

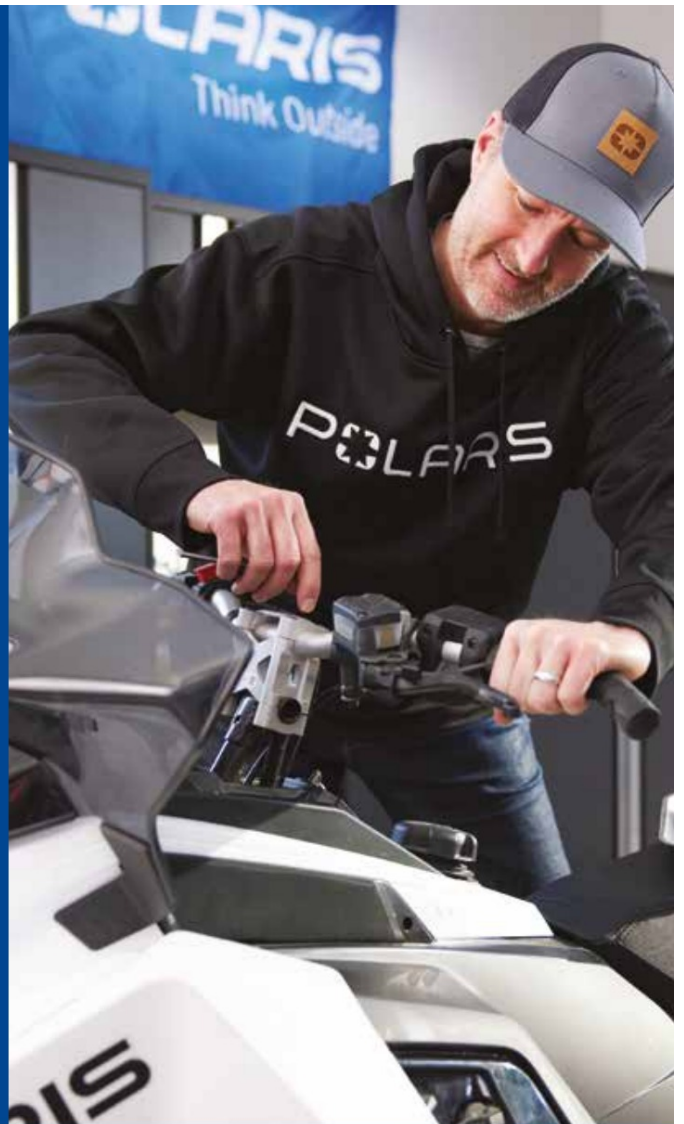

Oil and cleaners featured are for EU distribution only.  
For other availability, contact your local dealer.





## MAINTENANCE

### SPARK PLUGS

New spark plugs, engineered specifically for your Polaris snowmobile, ensure quick starts, fuel efficiency and peak performance.

### BATTERIES

Cold weather, harsh conditions and time can degrade a battery. A genuine Polaris replacement ensures an exacting fit and starting performance.

### DRIVE BELTS

Only genuine Polaris Engineered Drive Belts provide a fit and optimum compound for maximum performance and reliability.

### BREAK-IN PERIOD

The break-in period for a new belt is 50 miles (80.5 kilometers). During this time, vary at moderate speeds while avoiding wide-open throttle.



# FOR THE LIFE OF YOUR RIDE

We do more than build the world's greatest snowmobiles. We also work tirelessly to ensure the maintenance products you need are engineered to the same demanding standards. When it comes to drive belts, lubricants, batteries and more, we invest the time to make sure they're right, so you can spend more time riding.



SCAN THE QR CODE TO SEE OUR  
LATEST MAINTENANCE TIPS

## MAINTENANCE SCHEDULE

### PRE-SEASON

#### ENGINE OIL:

Fill to Recommended Level

#### GENERAL LUBRICATION:

All Fittings, Pivots, Cables, etc.

#### CHECK FOR WEAR:

Test, Clean & Check Fluid Levels

Spark Plugs, Track, Slider, Drive Belt & Carbides

2 - STROKE

#### ENGINE OIL:

Fill to Recommended Level

#### GENERAL LUBRICATION:

All Fittings, Pivots, Cables, etc.

#### CHECK FOR WEAR:

Test, Clean & Check Fluid Levels

Spark Plugs, Track, Slider, Drive Belt & Carbides

4 - STROKE

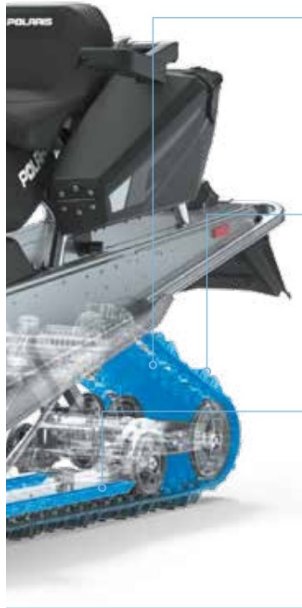

### TRACKS

Enhance traction and control or replace a worn track with the latest trend in track pitch, length, lug height and patterns.

### STUDS

Enhance your snowmobile's traction, control and performance with premium studs designed for your sled, track and riding style.

### RAIL SLIDERS

Replace worn hyfax with genuine Polaris rail sliders for a perfect fit and engineered compound for optimum performance.

### CARBIDES

Replace worn carbides or enhance your sled's handling with engineered exact fit wear bars with your choice of high-wear carbide length.

# MAINTENANCE PARTS



### BATTERIES

2-Stroke | 4013046: YTX20  
2-Stroke | E04999: ETX20  
4-Stroke | 4018013



### OIL FILTER

2522606



### SPARK PLUGS

Engineered for your Polaris sled  
2-Stroke | NGK® | 3022082  
2-Stroke | NGK® | 3024357  
2-Stroke | Champion | 3070190  
4-Stroke | NGK® | 3022662

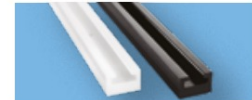

### RAIL SLIDERS

5521632      5521633-309  
5521633-070      5522144-070

Check your owner's manual for additional recommended service items and vehicle-specific timing.

### 500mi (800km) IN-SEASON

**ENGINE OIL:**  
Fill to Recommended Level

**DRIVE BELT:**  
Inspect & Adjust  
Follow Break-In Procedure After Installation

**TRANSMISSION FLUID:**  
Change

### 2,000mi (3,200km) IN-SEASON

**ENGINE OIL:**  
Fill to Recommended Level

**CHECK FOR WEAR:**  
Test, Clean & Check Fluid Levels  
Spark Plugs, Track, Slider, Drive Belt & Carbides

**DRIVE BELT:**  
Inspect & Adjust  
Replace as Needed

### END OF SEASON

**DRIVE BELT:**  
Remove  
Consult Owner's Manual

**FUEL:**  
Add Fuel Stabilizer

**TRACK:**  
Inspect  
Reduce Tension During Storage

**BATTERY:**  
Remove

**ENGINE OIL:**  
Change Oil & Filter  
Follow Break-In Procedure

**DRIVE BELT:**  
Inspect & Adjust  
Follow Break-In Procedure After Installation

**TRANSMISSION FLUID:**  
Change  
Follow Break-In Procedure

**ENGINE OIL:**  
Fill to Recommended Level

**CHECK FOR WEAR:**  
Test, Clean & Check Fluid Levels  
Spark Plugs, Track, Slider, Drive Belt & Carbides

**DRIVE BELT:**  
Inspect & Adjust  
Replace as Needed

**ENGINE OIL:**  
Change Oil & Filter (annually or every 4,000 mi / 6,437 km)

**DRIVE BELT:**  
Remove  
Consult Owner's Manual

**FUEL:**  
Add Fuel Stabilizer

**TRACK:**  
Inspect  
Reduce Tension During Storage

**BATTERY:**  
Remove or Connect Trickle Charger

# THE LIFE OF YOUR RIDE, ONLY THE BEST WILL DO

Top reliability and performance are the most important factors in Polaris Engineered Lubricants. Polaris Engineered Lubricants are engineered alongside the ever-evolving technology of Polaris high-performance engines to ensure you get an oil that is perfectly matched for your machine. Thousands of hours of testing every fluid in every engine design ensure you are getting the best product to keep you on the snow with your engine running strong.



## LUBRICANTS DESIGNED FOR RELIABILITY AND PERFORMANCE

The latest engine technologies need to be matched with the latest lubricant technology. Only Polaris Engineered Lubricants are designed and tested along with new Polaris engine technologies including turbocharged 2-stroke snowmobile engines, and 4-stroke snowmobile engines.

## OIL DEVELOPMENT

POLARIS INVESTS IN EACH OIL AT AND ABOVE THESE LEVELS.

12 DEDICATED  
TEAM MEMBERS

FOCUSED ON  
POLARIS OIL

1,000+  
HOURS

DYNO TESTING

18+  
MONTHS

DEVELOPMENT  
& TESTING

40,000 / 64,374  
MILES / KILOMETERS

FIELD TESTING



## KEY POINTS OF PROTECTION

### PISTON

Pistons play a critical role in engine operation and the wrong oil can lead to power loss, scuffing and poor performance.

- Maximizes power output while providing excellent film retention to prevent scuffing
- Superior stability in high temperatures, while minimizing carbon deposits and increasing long term reliability
- Oil flows at low temperatures to prevent hard starting



### CRANKSHAFT BEARING

Provides hydrodynamic barrier on bearing interfaces to extend upper and lower rod bearing life.

- Provides accurate oiling under extreme cold conditions
- Excellent film retention and heat transfer properties
- Corrosion inhibitors protect during off-season storage

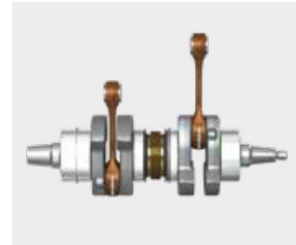

### EXHAUST VALVE OPERATION

Exhaust valves control power output during on and off throttle use. Improper lubricants can cause carbon buildup and sticking of valves, reducing power.

- Provides detergency over the life of the exhaust valves
- Minimizes carbon buildup to ensure exhaust valves continue to move freely and keep the engine running at peak power
- Designed to provide smooth valve operation throughout the life of the engine





### POLARIS BLUE

Synthetic-blend 2-cycle oil formulated for reliable protection in all non-exhaust valve (non-VES) 2-cycle applications.

#### OUR FORMULATION

- Semi-synthetic formula
- High lubricity
- Proprietary corrosion additive package

#### YOUR ADVANTAGE

- Easier cold starting
- Prevents rust and corrosion
- Reduces wear for dependable performance



PRE-MIX ENGINES



FAN-COOLED ENGINES

1 L  
502571

4 L  
502495

### VES

Full synthetic formulation designed to improve exhaust valve performance and offer excellent engine protection.

#### OUR FORMULATION

- Full synthetic formula
- Proprietary anti-wear, corrosion and detergency-additive package
- Retains film on critical engine parts after hot shutdown

#### YOUR ADVANTAGE

- Approved for use in all non-turbo 2-cycle snowmobile engines
- Greater wear protection and cleaner burning with less deposits for maximum engine life
- Reduced cold start effort and wear



PRE-MIX ENGINES



FAN-COOLED ENGINES



NON-BOOST LIQUID COOLED ENGINES

1 L  
502493

4 L  
502514

25 L  
502515

60 L  
502516

204 L  
502517

## OIL FOR EVERY SLED, PROVEN IN THE TOUGHEST RACE.

When you're flying across 3,219 kilometers of Alaskan tundra, racing riders and the bitter winter wind to seize your immortal moment, you need equipment you can count on. Iron Dog® snowmobile riders count on Polaris Engineered Oils & Lubricants™ to withstand sub-zero temperatures, mountain ranges, and rock hard wind drifts at high speed over a grueling 35 hours.

They know Polaris® Engineers rigorously test every fluid before it earns the Polaris Engineered Lubricants™ badge and a spot on the shelf. So inside and out, their sled will be just as strong as their will to win. Whether you're racing across the Alaskan wilderness or just casually riding on a trail, you can be confident there's no better oil for your sled than Polaris Engineered Oils & Lubricants™.

# POLARIS®

## ENGINEERED LUBRICANTS

GARAGE

MAINTENANCE

OIL

LUBRICANTS &  
GARAGE ACCESSORIES

BELTS, HO PARTS  
& BATTERY CHARGERS

POLARIS POWER

SERVICE PARTS



### VES EXTREME

Ultimate full synthetic formulation to meet the demands of the highest performance engines including turbo-charged 2-cycle snowmobile engines in the most extreme conditions.

#### OUR FORMULATION

- Extreme full synthetic, 100% PAO and Ester formulation
- Highest engine film strength and lubricity protection
- Next generation proprietary anti-wear, corrosion and detergency additive system

#### YOUR ADVANTAGE

- Best engine-wear protection
- Maintains highest engine performance
- Ultimate cold weather starting performance and protection
- Cleanest engine components



4 L  
502691 VES EXTREME. ONLY  
AVAILABLE IN 4 LITERS

FOR OTHER SIZES 25L & 200L  
CONTACT YOUR DEALER.

### PS-4 EXTREME 0W-50

Ultimate full synthetic 4-cycle formulation approved for use in all 4-cycle snowmobile engines.

#### OUR FORMULATION

- Extreme full synthetic base oils - PAO and Ester
- Widest viscosity range 0W-50 protects from below -45°F (-43°C) to over 130°F (54°C)
- Moly-boost, ZDDP and Clean Engine additives

#### YOUR ADVANTAGE

- Highest performance in the most extreme conditions
- Ultimate cold weather starting performance and protection
- Outstanding engine wear protection for best reliability



1 L  
503220

25 L  
503233

204 L  
502235

4 L  
503221

60 L  
503236

**OIL DEVELOPMENT**  
POLARIS INVESTS IN EACH OIL  
AT AND ABOVE THESE LEVELS.

**12 DEDICATED**  
TEAM MEMBERS

**FOCUSED ON**  
POLARIS OIL

**18+**  
MONTHS

**DEVELOPMENT &**  
TESTING

**1000+**  
HOURS

**DYNO TESTING**

**64,374**  
KILOMETERS

**FIELD TESTING**

## LUBRICANTS

# ENGINEERED TO MAXIMIZE THE LIFE OF YOUR RIDE

All Polaris fluids, from antifreeze to brake fluid, are developed for your vehicle. Trust the only fluids perfectly engineered for your needs.



### CARBON CLEAN

Polaris® Carbon Clean prevents ethanol corrosion, stabilizes fuel, and cleans carburetor jets and fuel injector nozzles, deposits on piston and rings, intake systems, and combustion chambers. Antioxidants preserve fuel and prevent fuel system gumming.

125 ml | 502528



### SYNTHETIC CHAINCASE LUBE

Unlike typical gear case oils, SCL's unique viscosity range allows instant flow and film protection in extreme cold or high heat environments.

1 L | 502560  
25 L | 502561  
201 L | 502562



### ANTI-FREEZE

Polaris® Extended Life Anti-Freeze contains organic acid technologies to prevent corrosion on metal components, eliminate scaling, and maximize cooling system performance.

1 L | 502566  
25 L | 502567  
206 L | 502568



### DOT 4 BRAKE FLUID

Polaris® DOT 4 Brake Fluid is designed for use in Polaris® hydraulic brakes. Superior high-temp characteristics plus anti-corrosion additives extend the life of brake system components.

250 ml | 502526



### OIL

Polaris® Blue, VES, and VES Extreme 2-cycle oils are tested to perform, and are the only oils developed specifically for your Polaris® snowmobile engine. Exclusive anti-wear additives protect engine parts with extra rust and corrosion protection.

2-Cycle oils Part numbers. See previous page.



### ALL-SEASON GREASE

Polaris® All-Season Grease is designed to maintain consistency across a wide range of temperatures. Engineered to protect front and rear suspension components, steering bushings, and driveline bearings.

400 gr | 502538



### SHOCK OIL

1 L | 502518



### FUEL STABILIZER

- Advanced Fuel Treatment prevents ethanol corrosion and stabilizes fuel for up to 2 years. Dual-antioxidant formula protects against gum and varnish for easy starting

125 ml | 502100

## CLEAN

### ALL-PURPOSE CLEANER

- Professional grade, non-streak and biodegradable universal cleaner for the whole sled

500 ml | 502533



## SHINE

### INSTANT SHINE & DETAILER

- Quick and protective cleaning for a sparkling clean result. Polaris Instant Shine and Detailer does not need additional water! Ideal for plastics, glass, varnishes, metals as well as windshields and visors

500 ml | 502546



Oil and cleaners featured are for EU distribution only. For other availability, contact your local dealer.



## GARAGE ACCESSORIES



### OIL CHANGE TOOL KIT

Kit Includes:  
 1 - 6.5 Quart Drain Pan  
 1 - 1 Pint Oil Funnel with Screen  
 1 - Oil Filter Wrench\*  
 2 - 15" x 18" Absorbent Pads  
 1 - Clean Up Wipe  
 2 - Pairs of 6 Mil Nitrile Gloves  
 4 - Blue Interfold Shop Towels

2830545



### OIL FILTER WRENCH

Remove 4-stroke engine oil filters with ease  
 2830550



### 2D BATTERY-OPERATED SIPHON PUMP

Liquid transfer pumps 5-6 quarts/min suctioning power  
 2830513



### FLUID SYRINGE

Easily add and remove fluid from your vehicle like Synthetic Chaincase Lube  
 2830553



### POLARIS LED POCKET FLASHLIGHT

Black | 2830436



### WORK LIGHT - 550 LUMENS

UV & dual charging  
 2830584

\* Oil filter wrench not compatible with S4 4-stroke engine



### PREMIUM MAINTENANCE TOOL KIT

- Includes everything you need to work on and repair Polaris vehicles
- Lifetime warranty on select tools

2830565



### POLARIS SHOP TOWELS

200 ct with dispenser | 2830402  
 200 ct refill | 2830403



### FLUID FUNNEL

Easily add oil with high accuracy  
 2830552



### FLUID TRAY

Holds up to 8 quarts of fluid  
 2830551



### POLARIS 33" TELESCOPIC MAGNET

Black | 2830435



### WORK LIGHT - 1000 LUMENS

2830585



### SNOW DOLLY

- 3" big-wheel caster design
- Move your sled around the garage with ease

2882959



### 1.5" x 15' 5,500 LB. RATCHET STRAP 2000KG

- Keep your Snowmobile, ATV or Ranger safely strapped at your trailer.
- Dimension 3,5cm/ 50cm/ 550cm
- Max load 2000kg/ working load 1000kg
- 2 pac

POL05031



### POLARIS MAGNETIC PARTS TRAY

Silver | 2830432



### POLARIS 12" HI-TORQUE RATCHETING DRIVER

Black/Blue | 2830434



### WORK LIGHT - 4000 LUMENS

16ft cable reel  
 2830586

# POLARIS ENGINEERED DRIVE BELTS



## OUR INVESTMENT PER BELT

- 20,000 miles (32,187 kilometers) of field testing
- Thousands of dyno hours
- 18+ months of development (3,000+ design hours) per belt
- 1,200+ vehicle validation hours
- Collaboration with powertrain and clutch engineers

## YOUR ADVANTAGE

- No clutch recalibration
- Less wear and tear due to heat
- Ensure maximum performance of your vehicle
- More time out riding, less time wrenching

BELT COMPOUND & CONSTRUCTION NOTES	BELT WIDTH*	OUTER CIRCUMFERENCE*	PART NUMBER
<b>MATRYX/AXYS: RMK, RUSH, SWITCHBACK (ALL), VOYAGEUR, TITAN, INDY (ALL)</b>			
High Modulus Chloroprene Belt	1.46" (37.10mm)	45.16"	3211215 (MY20-LATER 800 CLEANFIRE H.O. / 850 PATRIOT & PATRIOT BOOST)
High Modulus Chloroprene Belt	1.46" (37.10mm)	45.51"	3212325 (PRO STAR S4 / PATRIOT BOOST INDY / SWITCHBACK)
PBO Belt	1.46" (37.10mm)	45.16"	3211177 (800 CLEANFIRE H.O.)
PBO Belt	1.46" (37.10mm)	45.16"	3211165 (600 CLEANFIRE / 650 PATRIOT)
<b>MATRYX/AXYS: PRO-RMK, RMK ASSAULT, SKS &amp; KHAOS RMK</b>			
High Modulus Chloroprene Belt	1.46" (37.10mm)	46.77"	3211216 (MY20-LATER 800 CLEANFIRE / 850 PATRIOT / PATRIOT BOOST / PATRIOT 9R)
PBO Belt	1.46" (37.10mm)	46.77"	3211183 (800 CLEANFIRE H.O.)
PBO Belt	1.46" (37.10mm)	46.77"	3211115 (600 CLEANFIRE / 650 PATRIOT)
<b>PRO-RIDE: RUSH, SWITCHBACK, SWITCHBACK ASSAULT, INDY, VOYAGEUR, PRO-RMK, RMK, RMK ASSAULT</b>			
PBO Belt	1.46" (37.10mm)	46.77"	3211115
KEVLAR® Belt	1.46" (37.10mm)	46.77"	3211122
KEVLAR® Belt	1.32" (33.53mm)	43.23"	321174 (550 LIBERTY)
Standard Belt	1.29" (32.77mm)	42.48"	3211154 (550 LIBERTY)

**FIND THE RIGHT BELT FOR YOUR MACHINE IN OUR ONLINE PARTS CATALOG AT [POLARIS.COM](https://www.polaris.com)**

\*Belt dimensions are given in nominal dimensions. There is a +/- variance for all critical dimensions. Clutch setup must be inspected when a new belt is installed and should be adjusted if necessary. The drive belt is an important component in the CVT system. In order to achieve maximum efficiency from the converter, drive-belt deflection (tension), clutch offset and alignment must be adjusted properly. See your service manual for further details on drive-belt measurement inspection.

# HD HEAVY DUTY PARTS

All Polaris parts are developed and tested to help you get the most out of your ride. We're taking the passion of our riders to the next level with HD Parts.

## ENGINEERED AND DESIGNED FOR:

- Greater durability
- Greater wear and tear capabilities
- Enhanced performance
- Extreme conditions



### BRAKE PADS

Hayes race inspired PRT brake pads utilize proven technology and material that is warp resistant and provides a consistent feel in all temperature ranges and environments.

OE	HD HEAVY DUTY PARTS
2204036	2209690
2205500	
2206251	

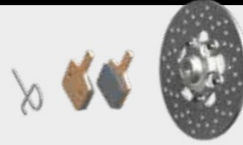

### BRAKE PAD KIT

Easily update the entire brake system with HD Pads (2209690) and Hayes Pro-Float 5R Rotor to provide maximum performance.

OE	HD HEAVY DUTY PARTS
2205373	2209691
2206235	

LEARN MORE AT [POLARIS.COM/HDPARTS](http://POLARIS.COM/HDPARTS)

### BATTERY CHARGER



## POLARIS CT5 POWERSPORT

Your powersport vehicle always needs to be in top condition to give you the best possible performance. Powersport vehicles are sometimes stored for long periods and therefore the CT5 POWERSPORT charger allows the batteries are charged to their capacity and that the vehicle is ready to run when you are. The CT5 POWERSPORT has been created specifically for charging and maintenance charge all types of batteries in your power sports vehicle. The charger uses advanced technology to give you three full automatic charging programs - Normal: for all lead-acid batteries, incl. AGM, Lithium\*: for all lithium\* batteries and Recond for deeply discharged wet lead acid batteries. You can connect the charger directly to the battery indefinitely and it will not overcharge or undercharge the batteries. It is easy to use and works with all types of 12 V batteries for your power sports vehicle.

12V lithium batteries (LiFePO4, Li-Fe, Li-iron, LFP)

- In 240V,
- Output power 2.3A,
- Battery 5-25Ah
- Battery voltage 12V
- Operating temp -20 to +50C
- Battery types 12 V: WET; MF; Ca/Ca; AGM; EFB; GEL; LiFePO4
- Protection class, IP65
- Fits Polaris own charging socket SAE type\*

Delivered with: Indicator, Ring contact for fixed mounting, Clamp contacts. SAE connector\*

# POLARIS ENGINEERED SERVICE PARTS DELIVER UNMATCHED PERFORMANCE AND FIT FOR YOUR SLED.

Our engineers at Polaris create snowmobile parts that push the limits of weight versus strength. We build our parts to feel lighter without sacrificing strength and durability. But over time, your sled will eventually need some service. When we're engineering our high-performance components, we keep serviceability in mind. From a quick clutch inspection to a ski alignment, we build our products as a system, so that anyone with the right tools and training can easily maintain their vehicle—and get back on the trails where your snowmobile belongs.

CHECK OUT OUR **PARTS FINDER ON POLARIS.COM**  
FOR EASY PARTS LOOK UP, PARTS IDENTIFICATION, VIEWS OF ASSEMBLIES & MORE!

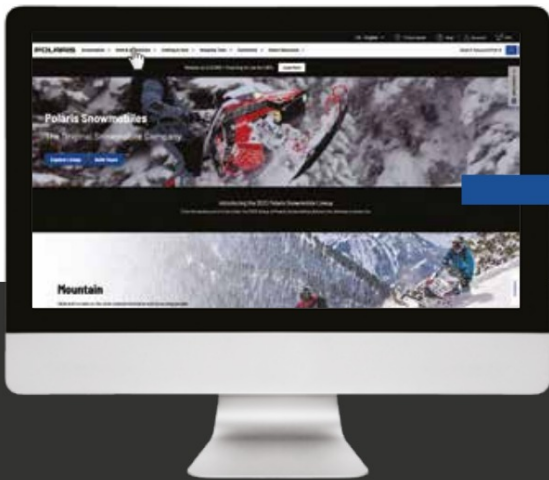

**STEP 1**

- Visit [snowmobiles.polaris.com](http://snowmobiles.polaris.com)
- Click "Parts & Accessories" tab
- Click "Parts, Oil & Maintenance"

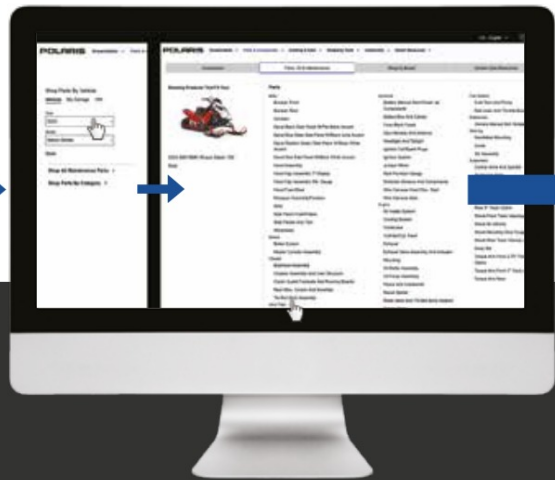

**STEP 2**

- Enter **vehicle year/model**
- then **select the part**

OVER  
**100,000**  
PARTS AVAILABLE!

Find helpful links, articles, and maintenance parts information.  
**ACCESS THE POLARIS HELP CENTER AT POLARIS.COM**

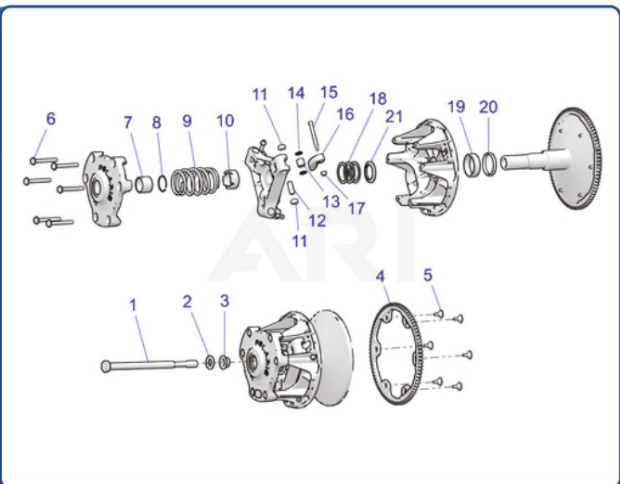
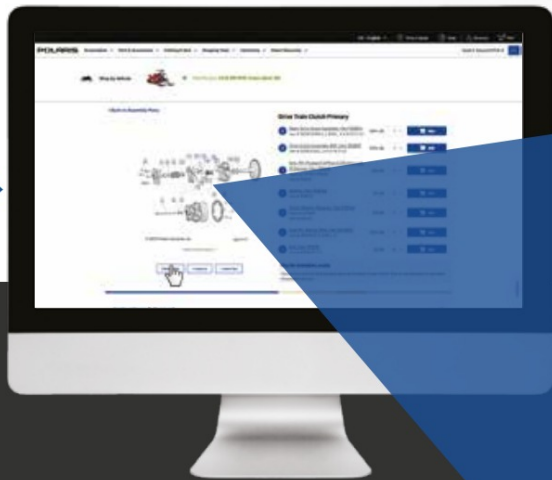

**STEP 3**

Clearly see what parts are required and **order**

**SHOP FOR SERVICE PARTS  
ONLINE OR VISIT YOUR POLARIS DEALER**

**GARAGE**

MAINTENANCE

OIL

LUBRICANTS &  
GARAGE ACCESSORIES

BELTS, HD PARTS  
& BATTERY CHARGERS

POLARIS POWER

SERVICE PARTS

## GLOSSARY

### SIZING GUIDE

#### MEN'S JACKET & BIB SIZING

SIZE	S	M	L	XL	2XL	3XL	4XL	5XL	MT	LT	XLT	2XLT
CHEST	34-36	38-40	42-44	46-48	50-52	54-56	58-60	62-64	38-40	42-44	46-48	50-52
SLEEVE*	33-35	33-35	34-35	34-35	34-35	34-35	34-35	34-35	33-35	34-35	34-35	34-35
WAIST	31-33	35-37	39-41	43-45	47-49	51-53	55-57	59-61	35-37	39-41	43-45	47-49
HIPS/SEAT	34-36	38-40	42-44	46-48	50-52	54-56	58-60	62-64	38-40	42-44	46-48	50-52
INSEAM	30-35	30-35	30-35	30-35	30-35	30-35	30-35	30-35	36-37	36-37	36-37	36-37

\*MEASURE SLEEVE LENGTH FROM CENTER BACK NECK

#### WOMEN'S JACKET & BIB SIZING

SIZE	S	M	L	XL	2XL	3XL
CHEST	32-34	35-38	39-42	43-46	47-50	51-54
SLEEVE*	29-30	31-33	31-33	31-33	31-33	31-33
WAIST	26-28	29-32	33-36	37-40	41-44	45-48
HIPS/SEAT	35-37	38-41	42-45	46-49	50-53	54-57
INSEAM	26-29	27-30	27-30	27-30	27-30	27-30

### HELMET SIZING GUIDE

SIZE	XS	S	M	L	XL	2XL	3XL	4XL	5XL
SIZE CODE	00	02	03	06	09	12	14	15	16
HAT SIZE	6 3/4	6 7/8-7	7 1/8-7 1/4	7-7 1/2	7 5/8-7 3/4	7 7/8-8	8	8 3/4	8 1/2
CIRCUMFERENCE	20 7/8"-21 1/4" (53-54cm)	21 5/8"-22" (55-56cm)	22 3/8"-22 3/4" (57-58cm)	23 1/8"-23 5/8" (59-60cm)	24"-24 3/8" (61-62cm)	24 3/4"-25 1/8" (63-64cm)	25 1/4"-26" (65cm)	26 3/8"-26 3/4" (66cm)	27 1/8"-27 1/2" (69-79cm)

## APPAREL



#### FIDLOCK® MAGNETIC TECHNOLOGY

An easy-on and easy-off magnetic closure device that delivers a quick, secure helmet strap closure on select 509 helmets.

#### DOT & ECE 22.05 CERTIFIED

The Department of Transportation (DOT) standard is enforced by the National Highway Traffic Safety Administration (NHTSA). For a helmet to be DOT-certified, it must pass a series of impact tests.



The Economic Commission for Europe (ECE) standard, R 22.05, is the most common helmet standard used internationally, as it is recognized by over 50 countries. To be ECE 22.05 certified, the helmet must pass a series of rigorous tests by an independent third-party lab.



#### TECH54

A waterproof and breathable membrane bonded to the shell fabric to block moisture from entering while allowing vapor moisture to escape from the inside.



#### SUPERIOR DURABLE WATER REPELLENCY

A Superior DWR coating causes water to bead up and run off, preventing precipitation from saturating the exterior of an outerwear piece.



#### BOA® LACING SYSTEM

The BOA® lacing system is easier to get on and off than traditional lace-up boots. Simply push to engage, turn to tighten and pull for quick release.



#### 3M® THINSULATE® INSULATION

3M® Thinsulate® Insulation is warm yet lightweight, powerful yet thin. It helps trap body heat while allowing moisture to escape.



#### 3M® SCOTCHLITE® REFLECTIVE MATERIAL

Patented 3M® Scotchlite® Reflective Material provides nighttime visibility from every angle.



#### YKK® ZIPPERS

The YKK® Fastening Products Group is trusted worldwide for impeccable production standards and thorough quality control processes for slide fasteners, plastic hardware, hook-and-loop fasteners, webbing tapes and snap-and-button products.



#### MOUNTAIN APPAREL

Uninsulated outerwear made of TECH54 20k/20k or 10k/10k material.



#### CROSSOVER APPAREL

Insulated outerwear made of TECH54 10k/10k material.



#### TRAIL APPAREL

Insulated outerwear made of TECH54 5k/5k material.

## ACCESSORIES + GARAGE



#### LOCK & RIDE

For Snow Accessories, a T-Slot tunnel attachment system.



#### CAMSO®

Customer-focused, world-class manufacturer and supplier of high-performance snowmobile tracks.



#### LOCK & RIDE FLEX

The fastest attachment system designed for tunnel-mounted snow accessories. Adapter kit sold separately to update a Lock & Ride attachment system to the Lock & Ride Flex system.

**POLARIS**  
**NORTHSTAR**  
**COOLER**



30, 60 & 105  
QUART FEATURES



ComfortCarry  
Handles



TravelLock  
System



EasyOut  
Drain System



NoSlip  
Rubber Feet



PolarWall  
Insulation



IceLock  
Seal

## KEEP IT ICE COLD

POLARIS NORTHSTAR COOLERS CAN SURVIVE JUST ABOUT ANYTHING, FROM  
EXTREME HEAT TO A FULL-ON BEAR ATTACK – IT'S IGBC CERTIFIED BEAR-RESISTANT



105 Quart



60 Quart



30 Quart



15 Quart



20 Quart  
Soft-Sided

LEARN ABOUT OUR LINE OF POLARIS NORTHSTAR COOLERS ONLINE AT  
[SNOWMOBILES.POLARIS.COM/NORTHSTARCOOLERS](http://SNOWMOBILES.POLARIS.COM/NORTHSTARCOOLERS)



# POLARIS 2024 LINEUP

## RMK®



9R PRO RMK SLASH 165    9R PRO RMK SLASH 155    9R RMK KHAOS SLASH 165    9R RMK KHAOS SLASH 155    9R RMK KHAOS SLASH 146    PATRIOT BOOST RMK KHAOS SLASH 165

### MOUNTAIN

## RMK®



PATRIOT BOOST RMK KHAOS SLASH 155    850 RMK KHAOS SLASH 155    850 RMK KHAOS SLASH 146    650 RMK KHAOS SLASH 146    850 RMK KHAOS 155    650 SKS 146

### MOUNTAIN

## SWITCHBACK®



PATRIOT BOOST SWITCHBACK ASSAULT 146    850 SWITCHBACK ASSAULT 146    650 SWITCHBACK ASSAULT 146    650 SWITCHBACK SP 146

### PERFORMANCE

## INDY®



PATRIOT BOOST INDY VR1137    850 INDY VR1137    650 INDY VR1137    650 INDY XCR 136

### PERFORMANCE

## INDY®

## TITAN

## NORDIC PRO

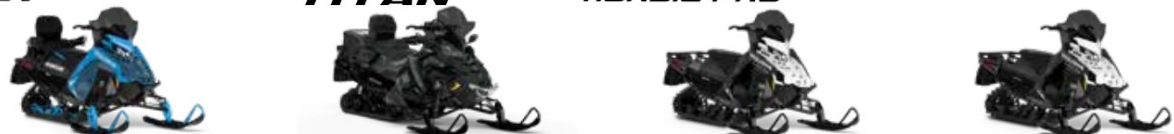

PROSTAR S4 INDY ADVENTURE 137    PROSTAR S4 TITAN ADVENTURE 155    PROSTAR S4 NORDIC PRO 146    650 NORDIC PRO 146

### CROSSOVER

### LIGHT UTILITY

Reservation regarding print-errors, deviation from the written content and color-deviation in the depicted material.

**POLARIS** | SNOWMOBILES