

EMEA VERSION



POLARIS

RZR

2019

ACCESSORIES + APPAREL





POLARIS[®]

RZR[®]

RZR is a brand fueled by the passion to do more for our loyal riders, since day one.

WE ARE THE DRIVING FORCE IN OFF-ROAD, built with the power and performance to dominate any terrain and push your limits. Polaris Engineered Accessories allow every rider to find their place, their unique one-of-a-kind machine to create the off-road experience as it was intended.



2019 LINEUP

XTREME PERFORMANCE



RZR RS1
NEW



RZR XP 1000 EPS



RZR XP TURBO



RZR XP TURBO S
NEW

TRAIL & SPORT



RZR 570 EPS



RZR 900 EPS



RZR S 900 EPS



RZR S 1000 EPS

4-SEAT



RZR S4 1000 EPS
NEW



RZR XP 4 1000



RZR XP 4 TURBO

2019 POLARIS

RZR

ACCESSORIES

POLARIS ENGINEERED.....	02
MAKE IT YOUR RZR CHECKLIST.....	04
INTRODUCING RZR XP TURBO S.....	06
LIGHTING.....	08
RIDE COMMAND / AUDIO.....	15
PRO ARMOR WHEELS & TIRES.....	30
BARRICADE CAGE SYSTEM.....	46
ROOFS.....	48
PROTECTION.....	50
DOORS.....	54
WINDSHIELDS / REAR PANELS.....	56
STORAGE / KOLPIN® GRIPS.....	58
COCKPIT ACCESSORIES.....	60
POLARIS NORTHSTAR COOLERS.....	62
WINCHES.....	64
GLACIER® PLOW SYSTEM / MISC.....	66
YOUTH 570 & 170 EFI.....	67

PARTS & GARAGE

OIL & LUBRICANTS.....	68
MAINTENANCE.....	70
GARAGE & TRAILERING.....	75

APPAREL & HELMETS

RIDING GEAR.....	76
CASUALWEAR.....	78



POLARIS
ENGINEERED

THE JOURNEY TO XTREME

PERFORMANCE

DESIGNED

POLARIS® OFFERS THE BROADEST LINEUP OF ACCESSORIES AND MOST INNOVATIVE SOLUTIONS IN OFF-ROAD. EACH ONE IS METICULOUSLY CRAFTED TO MATCH YOUR MACHINE.

TESTED

BY THE TIME YOU GET THIS GEAR, PROTOTYPES HAVE GONE THROUGH HELL IN OUR LAB AND BEEN EXTENSIVELY TESTED IN THE FIELD. YOU RIDE WITH 100% CONFIDENCE.





TRUSTED

WE'VE EARNED
RIDERS' TRUST OVER
DECADES AND WE
STAND BEHIND OUR
WORK.



POLARIS PARTNERS WITH THE BEST

We choose our partners carefully, selecting only the best in off-road. Every accessory is rigorously tested and validated to Polaris standards to ensure seamless integration and performance.

PRO ARMOR



LED LIGHTS p.10
WHEELS & TIRES p.32



RIGID

LED LIGHTS p.10



MBQUART

AUDIO p.18



KOLPIN OUTDOORS

ACCESSORIES p.61





MAKE IT YOURS

Whatever your style, however you ride
Polaris Engineered Accessories help you
create your one-of-a-kind RZR.

ESSENTIALS TO KEEP YOU RIDING LONGER

- Roofs Pg 50
- Windshields Pg 58
- Rear Panels Pg 59
- Doors Pg 56
- Protection Pg 52

ADD STYLE. ADD FUNCTION. ADD YOU.

- Audio Pg 18
- Lighting Pg 10
- Wheels & Tires Pg 32
- Winches Pg 66
- Storage Pg 60

THE RIGHT STUFF TO MAINTAIN YOUR RZR

- Oil & Lubricants Pg 70
- Maintenance Pg 74

EVERYTHING YOU NEED TO GEAR UP

- Riding Gear Pg 84
- Casualwear Pg 86



XTREME PERSONALIZATION

RZR XP 4 1000



TRAIL BUILT

RZR S 900



**XTREME
CAPABILITY**
RZR XP TURBO



**SPORT
CUSTOMIZED**
IDEAL FOR WIDTH RESTRICTED TRAILS
RZR S 1000

INTRODUCING THE **NEWEST RZR**

POLARIS

RZR XP
TURBO S

BIGGER & BADDER

From dark and sinister to brash and bold, you can make the unequalled RZR XP Turbo S truly one-of-a-kind.



LIGHTING

P. 10

AUDIO

P. 18

WHEELS & TIRES

P. 32

STORAGE & COCKPIT

P. 60-63

BARRICADE CAGE

P. 48

BUMPERS & PROTECTION

P. 52

WINDSHIELDS

P. 58

FROM **DUSK**

Extend your ride time and be more visible to others,
with the brightest light bars in the industry.

RIGID LIGHT BARS

A trusted name in the off-road lighting industry, Rigid® delivers unmatched technology and superior performance.



**BUILD YOUR
VISION**

'TIL

DAWN

PRO ARMOR LIGHT BARS

Pro Armor gives you aggressive styling, rugged protection, and lighting solutions for your riding needs.



POLARIS HEADLIGHTS AND ACCENTS

Replace your stock headlights, add more lumens to the trail, and keep the ride going into the night. The Trailblazer light features changeable custom-color bezels and LEDs that adjust from spot to flood for optimal light distribution.

OPTICS
& USAGE

DRIVING SPEED
& LIGHT ANGLE

ADD A
HARNESS

ACCESSORIES

RZR XP TURBO S

LIGHTING

RISE COMMAND
& AUDIO

WHEELS & TIRES

CAGES & ROOFS

BUMPERS &
PROTECTION

DOORS & WINDSHIELD/
REAR PANELS

STORAGE & COCKPIT
ACCESSORIES

COOLERS, WINCHES,
PLOWES & MISC.

BUILD YOUR

OPTICS

ACCENT

USAGE

DIFFUSED COLORED LIGHT ADDED FOR STYLE & PERSONALIZATION

- Durable, dust and water resistant construction
- Ideal for: Showcasing your lifted vehicle or custom suspension



DRIVING

GREAT FOR ALL RIDING STYLES, TERRAINS OR WORK APPLICATIONS

- Beam: Extra-wide, moderate center intensity
- Recommended Mounting: All points



FLOOD

BEST FOR WIDE-OPEN TERRAINS OR WORK APPLICATIONS REQUIRING BROAD LIGHT

- Beam: Wide, shorter
- Ideal for: Medium speeds when peripheral vision is important
- Recommended Mounting: Low & rear



DRIVING SPEED

ALL

SLOW TO MEDIUM

SLOW TO MEDIUM

LIGHT ANGLE

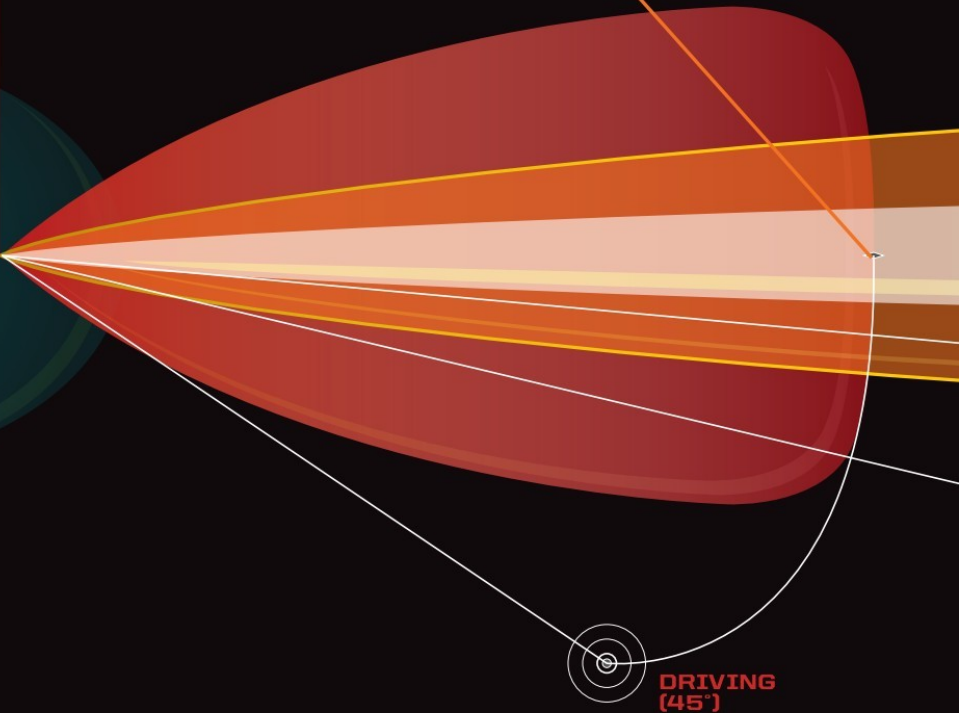

VISION

SPOT

BEST FOR TIGHT RIDING TERRAINS AND CONDITIONS REQUIRING LONG-DISTANCE VISIBILITY

- Beam: Concentrated long beam
- Ideal for: High speeds to see & react to your environment
- Recommended Mounting: High

COMBO

ALL-AROUND VERSATILITY FOR ANY RIDING TERRAIN, CONDITION OR WORK APPLICATION

- Beam: Combination of flood and spot optics
- Ideal for: All-around distance visibility
- Recommended Mounting: All points



HIGH

**COMBO
FLOOD & SPOT
(25'/10')**

**FLOOD
(25')**

**SPOT
(10')**

ACCESSORIES

RZR XP TURBO S

LIGHTING

RISE COMMAND
& AUDIO

WHEELS & TIRES

CAGES & ROOFS

BUMPERS &
PROTECTION

DOORS & WINDSHIELD/
REAR PANELS

STORAGE & COCKPIT
ACCESSORIES

COOLERS, WINCHES,
PUMPS & MISC.

POLARIS ENGINEERED
ADVANTAGES

DESIGNED

to mount perfectly to your
Polaris Engineered bumper, roof
or other mounting point

TESTED

for maximum performance

TRUSTED

to not overtax your machine



RIGID®

**ADVANCED
TECH**

RIGID® lights are driven by Aluminum PCB Smart Boards™. 6063-T5 aircraft aluminum extruded housings and Tiger Drylac® UV protection polyester powdercoating.

**EXCLUSIVE
OPTICS**

RIGID® invests heavily in optical science and has patented multiple optics and optics systems that maximize total light output and efficiency.

**ECE
CERTIFIED**

LIGHT BAR TYPES



SR-SERIES PRO

Sleek, powerful, low-profile (under 5 cm tall).
Lights extreme distances with low energy usage.
Available in 25.4 cm & 81.3 cm



D-SERIES PRO

Compact to fit almost anywhere with
high output and low energy usage.
Available in Driving, Flood & Spot

LIGHT BAR OPTIONS

OPTICS

DRIVING FLOOD

SPOT

1200 m
960 m
720 m
480 m
240 m

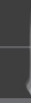

BRAND
SIZE
TYPE

RIGID®
POD
D-SERIES

RIGID®
25.4 cm
SR-SERIES

RIGID®
POD
D-SERIES

PRO ARMOR
27.9 cm
SINGLE-ROW

PRO ARMOR
25.4 cm
DUAL-ROW

PRO ARMOR
CUBE
DUAL-ROW

RIGID®
25.4 cm
SR-SERIES

RIGID®
POD
D-SERIES

PRO ARMOR
27.9 cm
SINGLE-ROW

RAW LUMENS

4,752

7,920

3,168

1,890

3,780

1,400

7,920

3,168

1,890

PN

2883128

2883122

2883126

2882313

2882311

2882312

2883121

2883127

2882078

Comes in a pair

Comes in a pair

Comes in a pair

ADD A HARNESS TO MOUNT YOUR LIGHTS

MODEL	LIGHT BAR SET-UPS		
	1 LIGHT IN 1 LOCATION ON 1 SWITCH	2 LIGHTS IN 2 LOCATIONS ON 1 SWITCH	2 LIGHTS IN 2 LOCATIONS ON 2 SWITCHES
2018-2019 RZR RS1	POLARIS PULSE LIGHT BAR HARNESS 2883388	POLARIS PULSE LIGHT BAR HARNESS 2883388 Y-HARNESS 2879860	POLARIS PULSE LIGHT BAR HARNESS (x2) 2883388
2014-2019 XP 1000 / XP 4 1000 900 / S 900 S4 900 / S4 1000	LIGHT BAR HARNESS 2883486	LIGHT BAR HARNESS 2883486 Y-HARNESS 2879860	LIGHT BAR HARNESS (x2) 2883486
2016-2019 XP TURBO / XP 4 TURBO XP TURBO S / S 1000			

ADD BATTERY CONNECTION CABLES FOR POWER

BUSBAR HARNESSES	
MODEL	BUSBAR HARNESS
RZR RS1 '18-19, XP TURBO/XP 4 TURBO '17-19, XP 1000/XP 4 1000 '18-19, XP TURBO S '18	HARNESS NOT REQUIRED, INCLUDED ON MACHINE
XP TURBO '16, XP 1000 '16-17, S 1000 '16-19, 900/S 900 '16-19, 900 XC '16-17	2881551
XP 1000 '14-15, 900/S 900/900 XC '15	2882862
XP 4 TURBO '16, XP 4 1000 '16-17, 4 900 '16-19, S4 1000 '19	2881646
XP 4 1000 '14-15, 4 900 '14-15	2882861

 All Rigid* and Pro Armor lights are Polaris Pulse ready.

PRO ARMOR



RUGGED CONSTRUCTION

Pro Armor lights are designed to be big and beefy with an aggressive style all their own, and housed in IP67 marine-grade rated UV polyester powdercoating.

MASSIVELY BRIGHT

Pro Armor builds bright lights designed for any riding experience. All that power is directed through heat dissipating aluminum for streamlined heat management.

ECE CERTIFIED

LIGHT BAR TYPES



DUAL-ROW LED LIGHT BARS

The most spread and farthest illumination downrange. Easy to mount.
Available in Cube, 25.4 cm, 50.8 cm & 76.2 cm



SINGLE-ROW LED LIGHT BARS

Powerful, compact, low-profile light bars with sleek look.
Available in 27.9 cm, 83.8 cm & 101.6 cm



CUBE LED LIGHTS

Small size allows mounting in strategic locations for added lighting.
Available in Flood & Spot

COMBO

OPTICS



ACCESSORIES

RZR XP TURBO S

LIGHTING

RISE COMMAND & AUDIO

WHEELS & TIRES

CAGES & ROOFS

BUMPERS & PROTECTION

DOORS & WINDOWSHIELD/ REAR PANELS

STORAGE & COCKPIT ACCESSORIES

COOLERS, WINCHES, PLOWS & MISC.

BLAZE YOUR TRAIL

TRAILBLAZER LED ADJUSTABLE HEADLIGHTS

- Direct replacement for factory headlight
- 6,000 lumen total output; 20-watt CREE® XHP LED Chips
- Durable construction is waterproof, dustproof, and fade resistant
- Adjustable beam pattern (outer two lights) allows for customized light patterns, from spot to flood, based on riding style and preference
- Integrated LED daytime running light
- Includes six black bezels

» BLACK BEZEL • 2882073

XP TURBO S '18, XP 4 1000/TURBO '14-19, XP 1000/TURBO '14-19, S4 1000 EPS '19, S 900 EPS '18, S 900 '18, S 1000 EPS '19, S 1000 '16-19, RZR RS1 '18, RZR RS1 '18, 900 S '15-18, 900 EPS '19, 900 '14-19, 4 900 '15-18, 1000 S '17-18

CONTROL BEAM PATTERNS

The Trailblazer LED headlight features adjustable beams on the inside and outside reflectors. Set the beam to your desired width or focus to dial in your beam pattern.

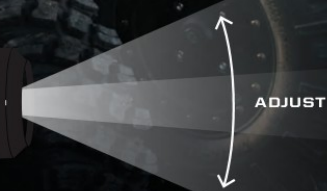

SHOWCASE YOUR STYLE

Be a shining beacon of color when you ride at night. With our colorful line of LED accent lights and headlight bezels, you can stand out from the rest of the pack and create an iconic ride.

MIX & MATCH COLOR BEZELS

- Personalize the look of your Trailblazer lights with interchangeable color-matched bezels
- Choose from a variety of colors, or mix and match



COLOR	2-PACK
WHITE	2882479-133
RED	2882479-293
BLUE	2882479-689
RAW	2882479

XP TURBO S '18, XP 4 1000/TURBO '14-19, XP 1000/TURBO '14-19, S4 1000 EPS '19, S 900 EPS '18, S 1000 EPS '19, S 1000 '16-19, RZR RS1 '18, RZR RS1 '18, 900 S '15-18, 900 EPS '19, 900 '14-19, 4 900 '15-18, 1000 S '17-18

ACCENT LIGHTS

- Kit includes four LEDs and all harnessing/switching required. Single lights can be added to the kit (kit required)
- Durable off-road ready construction that is both dust and water resistant
- Control hub and complete instructions included

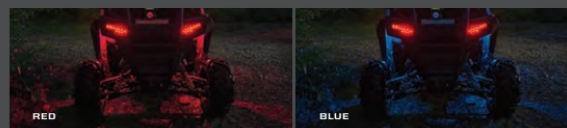

COLOR	LIGHTING KIT (4)	SINGLE LIGHT
RED	2880500	2880532
BLUE	2880506	2880533

XP TURBO S '18, XP 4 1000/TURBO '14-19, XP 1000/TURBO '14-19, S4 1000 EPS '19, S 900 EPS '18, S 1000 EPS '19, S 1000 '16-19, 900 S '15-18, 900 EPS '19, 900 '14-19, 570 '12-18, 4 900 '15-18, 1000 S '17-18

SEE P. 15 TO ADD HARNESSING

REVOLUTIONIZING THE OFF-ROAD EXPERIENCE



POLARIS® RIDECOMMAND®

TOTAL COMMAND CENTER FOR A WORLD OF CONNECTION AT YOUR FINGERTIPS

BUILT IN GPS WITH TOPOGRAPHY MAPS TO SEE YOUR LOCATION AND PLAN YOUR RIDE

MEDIA PLAYER WITH BUILT IN AM/FM TUNER FOR ALL YOUR FAVORITE MUSIC

BUDDY TRACKING AND SHARE YOUR RIDE USING THE RIDE COMMAND MOBILE APP**

HOLD A CONVERSATION WITHOUT SHOUTING AND SEE CALLS/TEXTS*

FALL AVAILABILITY

RIDE COMMAND 7" DISPLAY

- 7" high bright touchscreen visible in all conditions
- Displays critical vehicle information for fuel level, coolant temp and battery voltage
- Media player with built in AM/FM tuner
- Buddy tracking and share your ride with Ride Command mobile app
- Dedicated shortcut buttons for quick access to features
- Bluetooth® and USB smart phone connectivity
- Front and rear camera support for better visibility on and off trail

» 2884002

XP TURBO '19, XP 4 TURBO '19, XP 4 1000 '19, XP 1000 '19

FALL AVAILABILITY

RIDE COMMAND MOUNT KIT

- Mount your 7" touchscreen to RZR
- Replaces dash for seamless fit and finish
- Includes front and rear cameras with mounts
- Comes with wiring harnesses needed for RZR and accessory components, including all audio adapter harnesses

» 2884021

XP TURBO '19, XP 4 TURBO '19, XP 4 1000 '19, XP 1000 '19

DOWNLOAD THE RIDE COMMAND MOBILE APP



*Requires in-helmet communication

SEE P. 24-25 FOR  POLARIS
RIDECOMMAND® AUDIO SYSTEMS

ACCESSORIES

RZR XP TURBO S

LIGHTING

RIDE COMMAND
& AUDIO

WHEELS & TIRES

CAGES & ROOFS

BUMPERS &
PROTECTION

DOORS & WINDOWSHIELD/
REAR PANELS

STORAGE & COCKPIT
ACCESSORIES

COOLERS, WINCHES,
PLOWES & MISC.

OFF-ROAD GRADE AUDIO

When you research audio solutions for your Polaris *RZR*, you'll see manufacturers bragging about how their audio equipment is "Marine Grade". Or worse yet, you'll discover for yourself that they are repackaged components built for automotive applications. MB Quart[®], combined with Polaris, engineers Off-Road Grade Audio equipment that's proven to deliver the loudest, crispest sound in the harshest conditions. Rain, snow, mud, heat, cold, dust—**ANY PLACE YOUR *RZR* EXCELS, SO WILL YOUR AUDIO.**

RAIN

SNOW



ACCESSORIES

RZR XP TURBO S

LIGHTING

RISE COMMAND
& AUDIO

WHEELS & TIRES

CAGES & ROOFS

BUMPERS &
PROTECTION

DOORS & WINDSHIELD/
REAR PANELS

STORAGE & COCKPIT
ACCESSORIES

COOLERS, WINCHES,
PLOW & MISC.



MUD



SAND

SURROUNDED BY SOUND

POLARIS AND MB QUART™ partner to bring you an audio experience that is powerful and comprehensive. A full offering of solutions are available for your ultimate RZR audio build. Choose from loud to loudest. Each component is designed and engineered to enhance your surround sound experience while surviving the harshest environments.

MBQUART®

AUDIO ROOFS P. 22

AMPLIFIER P. 23

RIDE COMMAND P. 24

HEAD UNITS P. 22

BUILD YOUR SYSTEM

1 SELECT YOUR HEAD UNIT P. 22

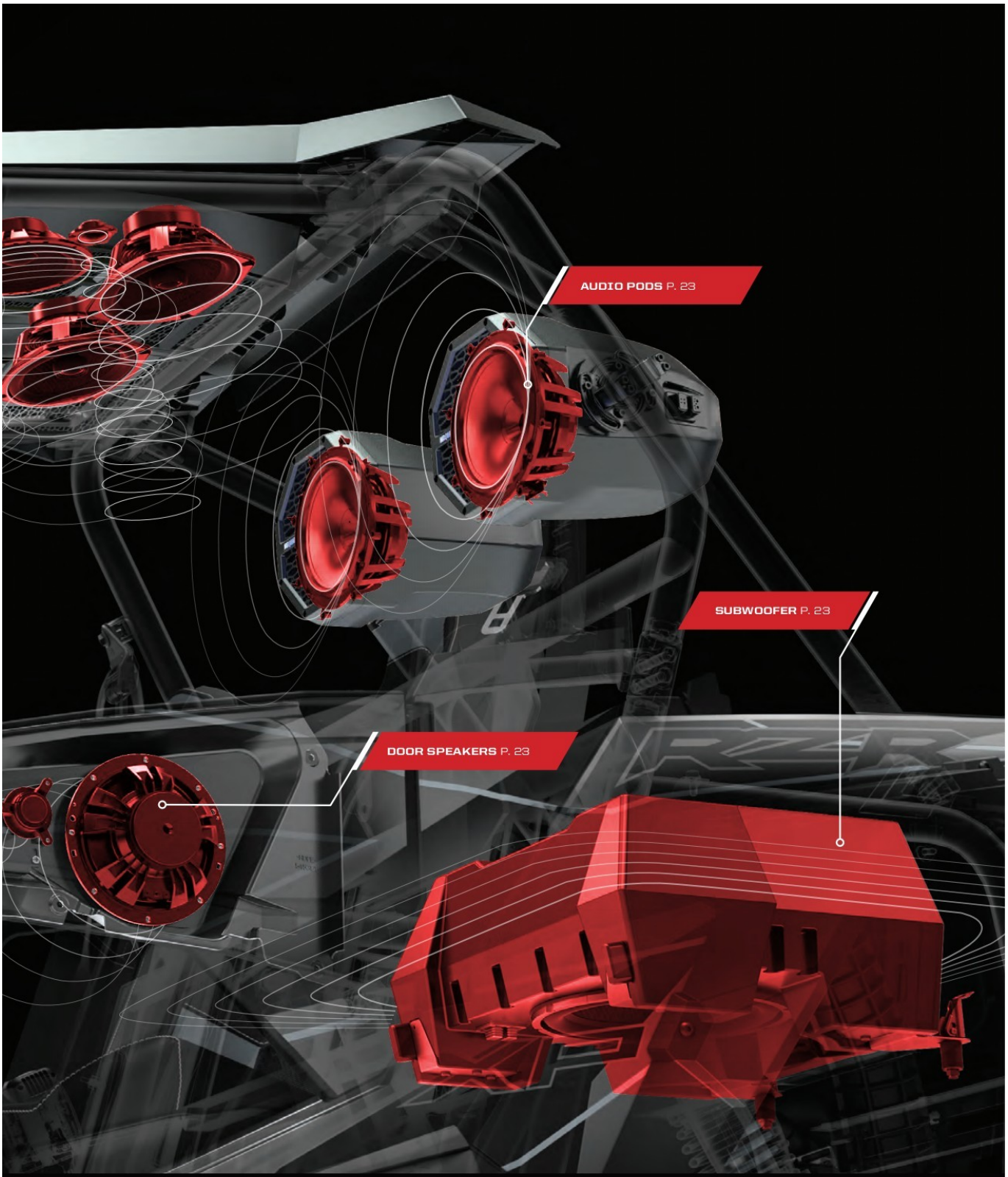

AUDIO PODS P. 23

SUBWOOFER P. 23

DOOR SPEAKERS P. 23

2 CHOOSE YOUR SPEAKERS P. 23

3 FIND YOUR FULL AUDIO SYSTEM P. 24

ACCESSORIES

RZR XP TURBO S

LIGHTING

RISE COMMAND & AUDIO

WHEELS & TIRES

CAGES & ROOFS

BUMPERS & PROTECTION

DOORS & WINDSHIELD/ REAR PANELS

STORAGE & COCKPIT ACCESSORIES

COOLERS, WINCHES, PLUMBS & MISC.

AUDIO SYSTEM HEAD UNITS

These solutions get you well on your way to hitting the trails with your favorite tunes. Each feature head-units, allowing you to control audio delivery. Both audio roofs and sound bars are all-in-one solutions that can serve as the base of an expanded system with more speakers.

AUDIO ROOFS

Add a Premium Audio Roof to your RZR and get an all-in-one solution for your sound. Easy to install and integrate into your build, this roof comes complete with an LED push-button stereo and high-efficiency 16.5 cm coaxial speakers for unbeatable sound.

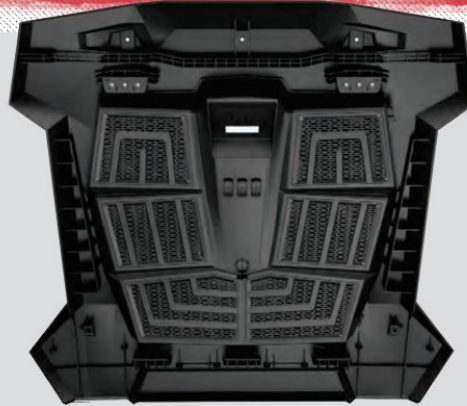

S4 AUDIO ROOF

» 2882064

XP 1000/TURBO '14-19, S 900 EPS '19, S 900 '19, S 1000 EPS '19, S 1000 '16-19, 900 S '15-18, 900 EPS '19, 900 '14-19, 1000 S '17-18

S8 AUDIO ROOF

» 2882065

XP 1000/TURBO '14-19, S 900 EPS '19, S 900 '19, S 1000 EPS '19, S 1000 '16-19, 900 S '15-18, 900 EPS '19, 900 '14-19, 1000 S '17-18

S10 AUDIO ROOF

» 2882066

XP 1000/TURBO '14-19, S 900 EPS '19, S 900 '19, S 1000 EPS '19, S 1000 '16-19, 900 S '15-18, 900 EPS '19, 900 '14-19, 1000 S '17-18

MODEL:	S4	S8	S10
BUILT-IN STEREO WITH BLUETOOTH®, AM/FM* RADIO AND AUX	×	×	×
MODULAR DESIGN FOR IMPROVED SERVICEABILITY AND ACCESS	×	×	×
(4) 16.5 cm COAXIAL SPEAKERS	×	×	×
(4) 16.5 cm COMPONENT SPEAKERS MIDS AND TWEETERS		×	×
(2) 15.2 cm x 22.9 cm COAXIAL SPEAKERS			×
4-CHANNEL 2-OHM 300W AMPLIFIER		×	×
83.8 cm SINGLE-ROW PRO ARMOR LIGHT BAR		×	
76.2 cm DUAL-ROW PRO ARMOR LIGHT BAR			×
DOME LIGHT		×	×

*The FM Frequency range is from 88 to 108 and only on the odds (i.e. 88.1, 88.3, etc.).



SOUND BAR 8

- Six mid-range/mid-bass speakers and two dedicated tweeters
- Integrated, self-powered amplifier for easy installation
- Waterproof speakers and controls
- Large, easy-to-use external controls

» 2881465

XP 4 1000/TURBO '14-19, XP 1000/TURBO '14-19, S4 1000 EPS '19, S 900 EPS '19, S 900 '19, S 1000 EPS '19, S 1000 '16-19, 900 S '15-18, 900 EPS '19, 900 '14-19, 4 900 '15-18, 1000 S '17-18

SPEAKER BAR HARNESS 2882280 REQUIRED, SEE RIGHT
BUSBAR HARNESS REQUIRED, SEE NEXT PAGE



SOUND BAR 4

- Two mid-range/mid-bass speaker and two dedicated tweeters

» 2881230

XP 4 1000/TURBO '14-19, XP 1000/TURBO '14-19, S4 1000 EPS '19, S 900 EPS '19, S 900 '19, S 1000 EPS '19, S 1000 '16-19, 900 S '15-18, 900 EPS '19, 900 '14-19, 570 '12-18, 4 900 '15-18, 1000 S '17-18

SPEAKER BAR HARNESS 2882280 REQUIRED, SEE RIGHT
BUSBAR HARNESS REQUIRED, SEE NEXT PAGE



SPEAKER BAR HARNESS

- Power connection for sound bars
- Used to connect sound bar to accessory busbar for power

» 2882280

XP TURBO S '18, XP 4 1000/TURBO '14-19, XP 1000/TURBO '14-19, S4 1000 EPS '19, S 900 EPS '19, S 900 '19, S 1000 EPS '19, S 1000 '16-19, 900 S '15-18, 900 EPS '19, 900 '14-19, 4 900 '15-18, 1000 S '17-18

BUSBAR HARNESS REQUIRED, SEE NEXT PAGE

HEAD UNITS

A head unit controls all aspects of your sound system. It lets you choose what you want to hear, when you want to hear it, and how loud you want the audio output.

DASH RADIO*

- A seamlessly integrated source unit to control all your audio needs
- Easy installation and great fit and finish
- Remote mounted USB / 3.5mm plug for external device connection
- Bluetooth® connectivity

» 2881988

XP TURBO S '18, XP 4 1000/TURBO '14-19, XP 1000/TURBO '14-19, S4 1000 EPS '19, S 900 EPS '19, S 900 '19, S 1000 EPS '19, S 1000 '16-19, 900 S '15-18, 900 EPS '19, 900 '14-19, 4 900 '15-18, 1000 S '17-18

*The FM Frequency range is from 88 to 108 and only on the odds (i.e. 88.1, 88.3, etc.).



RADIAL BLUETOOTH® REMOTE

- Keep your phone stowed away and play your favorite tunes through your RZR
- Includes two (2) audio outputs for easy addition of audio components
- Bluetooth® 4.0 connectivity
- 3.5mm AUX jack for direct connection to music source
- Mount in an any open switch panel. Control music via the easy to use joystick. Turn the dial for volume control and toggle left/right or up/down for track selection. Push dial for power and pause/play.

» 2883113

XP TURBO S '18, XP 4 1000/TURBO '14-19, XP 1000/TURBO '14-19, S4 1000 EPS '19, S 900 EPS '19, S 900 '19, S 1000 EPS '19, S 1000 '16-19, 900 S '15-18, 900 EPS '19, 900 '14-19, 4 900 '15-18, 1000 S '17-18



SPEAKERS

Build your dream audio system. From a simple setup with only door speakers, to complex system with door speakers, audio pods and a subwoofer—BUILD IT YOUR WAY.



EXTREME AUDIO PODS

- Two 20.3 cm coaxial speakers with 2.5 cm titanium tweeters in weatherproof enclosures
- Self-amplified 200-watt per speaker output
- Rear Audio Harness included

» 2883739

XP TURBO S '18, XP 4 1000/TURBO '14-19, XP 1000/TURBO '14-19, S4 1000 EPS '19, S 900 EPS '19, S 900 '19, S 1000 EPS '19, S 1000 '16-19, 900 S '15-18, 900 EPS '19, 900 '14-19, 4 900 '15-18, 1000 S '17-18

30.5 cm MAXBOOST SUBWOOFER

- High strength molded enclosure for optimal acoustics and superior fit
- Lock & Ride connectivity to cargo bed
- Integrated 250-watt Class D amplifier
- Deep bass 30.5 cm subwoofer with 5.1 cm voice coil
- Wiring harness included

» 2882063

XP TURBO S '18, XP 4 1000/TURBO '14-19, XP 1000/TURBO '14-19, S4 1000 EPS '19, S 900 EPS '19, S 900 '19, S 1000 EPS '19, S 1000 '16-19, 900 S '15-18, 900 EPS '19, 900 '14-19, 4 900 '15-18, 1000 S '17-18

DOOR SPEAKERS

- High performance 16.5 cm component speakers with 1.9 cm titanium dome tweeters
- Harnessing included to connect to audio amplifier
- Works with Polaris Aluminum Door kits or Polaris Lower Door kits
- Requires Audio Amplifier (2883738)

» FRONT • 2881989 (Set of two)

XP 4 1000/TURBO '14-19, XP 1000/TURBO '14-19, S4 1000 EPS '19, S 900 EPS '19, S 900 '19, S 1000 EPS '19, S 1000 '16-19, 900 S '15-18, 4 900 '15-18, 1000 S '17-18

» REAR (4-SEAT ONLY) • 2883116 (Set of two)

XP 4 1000/TURBO '14-19, S4 1000 EPS '19, 4 900 '15-18
REQUIRES FRONT DOOR SPEAKERS (2881989) CONNECTS DIRECTLY TO 2883738 AUDIO AMPLIFIER. NO ADDITIONAL AMPLIFIER NEEDED. HARNESSING INCLUDED.

RIDE COMMAND AUDIO ADAPTER

- Required to hook any audio components up to the Ride Command system
- Connect up to 2 speaker options and subwoofer
- Amp 3 specifically designed for subwoofer



» 2883232

XP TURBO S '18, XP 4 1000/TURBO '14-19, XP 1000/TURBO '14-19, S4 1000 EPS '19, S 900 EPS '19, S 900 '19, S 1000 EPS '19, S 1000 '16-19, 900 S '15-18, 900 EPS '19, 900 '14-19, 4 900 '15-18, 1000 S '17-18

REQUIRED WHEN ADDING AUDIO TO RIDE COMMAND 7" DISPLAY (2884002)
DOOR SPEAKERS AND AUDIO AMPLIFIER NOT RECOMMENDED WITH DYNAMIX ACTIVE SUSPENSION MODELS.

AUDIO AMPLIFIER

- This amplifier is a 200-watt TDA-based full-range Class D amplifier with fixed connections for power, ground and turn-on and Delphi connectors for door speakers
- Required with Door Speakers (2881989)

» 2883738

XP 4 1000/TURBO '14-19, XP 1000/TURBO '14-19, S4 1000 EPS '19, S 900 EPS '19, S 900 '19, S 1000 EPS '19, S 1000 '16-19, 900 S '15-18, 900 EPS '19, 900 '15-19, 4 900 '15-18, 1000 S '17-18

HARNESSES

Depending on your vehicle model, you may need to add a busbar harness and audio harnesses specific to your vehicle.

VEHICLE FITMENT	BUSBAR HARNESS
RZR RS1 '18-19, XP TURBO/XP 4 TURBO '17-19, XP 1000/XP 4 1000 '18-19, XP TURBO S '18	HARNESS NOT REQUIRED, INCLUDED ON MACHINE
XP TURBO '16, XP 1000 '16-17, S 1000 '16-19, 900/S 900 '16-19, 900 XC '16-17	2881551
XP 1000 '14-15, 900/S 900/900 XC '15	2882862
XP 4 TURBO '16, XP 4 1000 '16-17, 4 900 '18, S4 1000 '18	2881646
XP 4 1000 '14-15, 4 900 '14-15	2882861



Y-AUDIO HARNESS

- Y-Harness splits the audio signal to allow for additional audio components to be added

» 2883269

XP TURBO S '18, XP 4 1000/TURBO '14-19, XP 1000/TURBO '14-19, S4 1000 EPS '19, S 900 EPS '19, S 900 '19, S 1000 EPS '19, S 1000 '16-19, 900 S '15-18, 900 EPS '19, 900 '14-19, 4 900 '15-18, 1000 S '17-18



LINE OUT AUDIO HARNESS

- Harness designed to extend JST audio signal. Use to run JST audio signal from rear of audio roof to the front of the vehicle.

» 2881652

XP TURBO S '18, XP 4 1000/TURBO '14-19, XP 1000/TURBO '14-19, S4 1000 EPS '19, S 900 EPS '19, S 900 '19, S 1000 EPS '19, S 1000 '16-19, 900 S '15-18, 900 EPS '19, 900 '14-19, 4 900 '15-18, 1000 S '17-18



POLARIS

RIDECOMMAND[®]

AUDIO SYSTEMS



LOUDEST

TOTAL COMMAND CENTER FOR A WORLD OF CONNECTION AT YOUR FINGERTIPS

BUILT IN GPS WITH TOPOGRAPHY MAPS TO SEE YOUR LOCATION AND PLAN YOUR RIDE

MEDIA PLAYER WITH BUILT IN AM/FM TUNER FOR ALL YOUR FAVORITE MUSIC

BUDDY TRACKING AND SHARE YOUR RIDE USING THE RIDECOMMAND MOBILE APP**

HOLD A CONVERSATION WITHOUT SHOUTING AND SEE CALLS/TEXTS*

**Requires in-helmet communication*

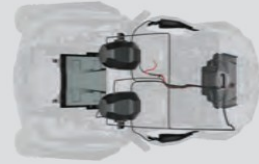

HEAD UNIT

- 2884002 Ride Command 7" Display
- 2884021 Ride Command Mount

SPEAKERS



- 2881989 Door Speakers
- 2883116 Rear Door Speakers (4-seat add-on only)
- 2883738 Audio Amp
- 2883739 Extreme Audio Pods
- 2882063 30.5 cm Subwoofer

HARNESSES

- 2883232 Ride Command Audio Adapter

Rear Audio Harness included with Pod Kit

BUSBAR HARNESS MAY BE REQUIRED, SEE RIGHT. DOOR SPEAKERS AND AUDIO AMPLIFIER NOT RECOMMENDED WITH DYNAMIX ACTIVE SUSPENSION MODELS.



HEAD UNIT

- 2884002 Ride Command 7" Display
- 2884021 Ride Command Mount

SPEAKERS



- 2881989 Door Speakers
- 2883116 Rear Door Speakers (4-seat add-on only)
- 2883738 Audio Amp
- 2882063 30.5 cm Subwoofer

HARNESSES

- 2883232 Ride Command Audio Adapter

BUSBAR HARNESS MAY BE REQUIRED, SEE RIGHT. DOOR SPEAKERS AND AUDIO AMPLIFIER NOT RECOMMENDED WITH DYNAMIX ACTIVE SUSPENSION MODELS.

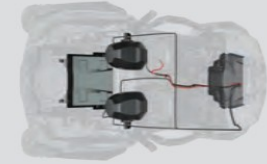

HEAD UNIT

- 2884002 Ride Command 7" Display
- 2884021 Ride Command Mount

SPEAKERS



- 2883739 Extreme Audio Pods
- 2882063 30.5 cm Subwoofer

HARNESSES

- 2883232 Ride Command Audio Adapter

Rear Audio Harness included with Pod Kit

BUSBAR HARNESS MAY BE REQUIRED, SEE RIGHT.

DOWNLOAD THE RIDE COMMAND MOBILE APP

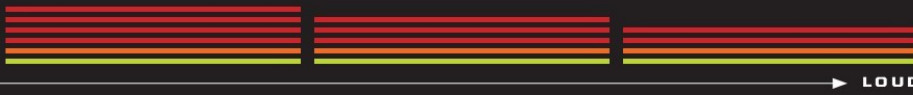

▶ LOUD

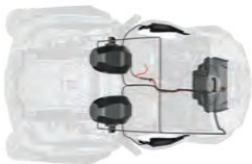

HEAD UNIT

- 2884002 Ride Command 7" Display
- 2884021 Ride Command Mount

SPEAKERS



- 2881989 Door Speakers
- 2883116 Rear Door Speakers (4-seat add-on only)
- 2883738 Audio Amp
- 2883739 Extreme Audio Pods

HARNESSES

- 2883232 Ride Command Audio Adapter
- Rear Audio Harness included with Pod Kit

BUSBAR HARNESS MAY BE REQUIRED. SEE RIGHT. DOOR SPEAKERS AND AUDIO AMPLIFIER NOT RECOMMENDED WITH DYNAMIX ACTIVE SUSPENSION MODELS.

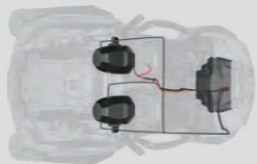

HEAD UNIT

- 2884002 Ride Command 7" Display
- 2884021 Ride Command Mount

SPEAKERS



- 2883739 Extreme Audio Pods

HARNESSES

- 2883232 Ride Command Audio Adapter
- Rear Audio Harness included with Pod Kit

BUSBAR HARNESS MAY BE REQUIRED. SEE RIGHT.



HEAD UNIT

- 2884002 Ride Command 7" Display
- 2884021 Ride Command Mount

SPEAKERS



- 2881989 Door Speakers
- 2883116 Rear Door Speakers (4-seat add-on only)
- 2883738 Audio Amp

HARNESSES

- 2883232 Ride Command Audio Adapter

BUSBAR HARNESS MAY BE REQUIRED. SEE RIGHT. DOOR SPEAKERS AND AUDIO AMPLIFIER NOT RECOMMENDED WITH DYNAMIX ACTIVE SUSPENSION MODELS.

BUSBAR HARNESS

Depending on your vehicle model, you may need to add a busbar harness and audio harness specific to your vehicle.

VEHICLE FITMENT	BUSBAR HARNESS
RZR RS1 '18-'19, XP TURBO XP 4 TURBO '17-'19, XP 1000/XP 4 1000 '18-'19, XP TURBO S '18	HARNESS NOT REQUIRED, INCLUDED ON MACHINE
XP TURBO '16, XP 1000 '16-'17, S 1000 '16-'19, 900/S 900 '16-'19, 900 XC '16-'17	2881551
XP 1000 '14-'15, 900/S 900/900 XC '15	2882862
XP 4 TURBO '16, XP 4 1000 '16-'17, 4 900 '18, S4 1000 '19	2881646
XP 4 1000 '14-'15, 4 900 '14-'15	2882861

Y-AUDIO HARNESS



- Y-Harness splits the audio signal to allow for additional audio components to be added
- » 2883269

LINE OUT AUDIO HARNESS



- Harness designed to extend JST audio signal. Use to run JST audio signal from rear of audio roof(s) to the front of the vehicle.
- » 2881652

RIDE COMMAND AUDIO ADAPTER



- Required to hook any audio Ride Command system
 - Connect up to 2 speaker options and subwoofer
 - Amp 3 specifically designed for subwoofer
- » 2883232

REQUIRED WHEN ADDING AUDIO TO RIDE COMMAND 7" DISPLAY (2884002)
DOOR SPEAKERS AND AUDIO AMPLIFIER NOT RECOMMENDED WITH DYNAMIX ACTIVE SUSPENSION MODELS.

AUDIO ROOF

AUDIO SYSTEMS

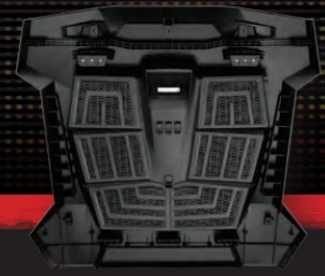

LOUDEST

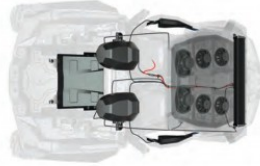

HEAD UNIT

- 2882064 S4 Audio Roof
- 2882065 S8 Audio Roof
- 2882066 S10 Audio Roof

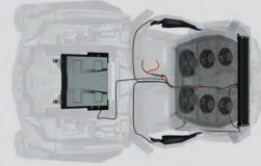

HEAD UNIT

- 2882064 S4 Audio Roof
- 2882065 S8 Audio Roof
- 2882066 S10 Audio Roof



HEAD UNIT

- 2882064 S4 Audio Roof
- 2882065 S8 Audio Roof
- 2882066 S10 Audio Roof

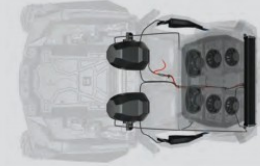

HEAD UNIT

- 2882064 S4 Audio Roof
- 2882065 S8 Audio Roof
- 2882066 S10 Audio Roof

SPEAKERS



- 2881989 Door Speakers
- 2883738 Audio Amp
- 2883739 Extreme Audio Pods
- 2882063 30.5 cm Subwoofer

SPEAKERS



- 2881989 Door Speakers
- 2883738 Audio Amp
- 2882063 30.5 cm Subwoofer

SPEAKERS



- 2883739 Extreme Audio Pods
- 2882063 30.5 cm Subwoofer

SPEAKERS



- 2881989 Door Speakers
- 2883738 Audio Amp
- 2883739 Extreme Audio Pods

HARNESSES

- 2883269 Y-Audio Harness (x2)
- 2881652 Line Out Audio Harness

Rear Audio Harness included with Pod Kit

HARNESSES

- 2883269 Y-Audio Harness
- 2881652 Line Out Audio Harness

HARNESSES

- 2883269 Y-Audio Harness
- Rear Audio Harness included with Pod Kit

HARNESSES

- 2883269 Y-Audio Harness
- 2881652 Line Out Audio Harness

Rear Audio Harness included with Pod Kit

BUSBAR HARNESS MAY BE REQUIRED, SEE RIGHT.

BUSBAR HARNESS MAY BE REQUIRED, SEE RIGHT.

BUSBAR HARNESS MAY BE REQUIRED, SEE RIGHT.

BUSBAR HARNESS MAY BE REQUIRED, SEE RIGHT.

S4 AUDIO ROOF

The RZR Audio Roof S4 delivers a factory look but with the benefit of a 160-watt, AM/FM Bluetooth® stereo system with four 16.5 cm coaxial speakers designed and manufactured by MB Quart®.

S8 AUDIO ROOF

When your ride demands sound and lights, the RZR Audio Roof S8-L is the best choice. This step-up system delivers a factory-look roof with more power.

S10 AUDIO ROOF

Take a seat under more sound and more lights. The RZR Audio Roof S10-L is the top of the line choice for audio and LED lighting integrated into a RZR roof. This top-tier system delivers a factory-look roof with more power in a 300-watt, AM/FM Bluetooth® system with ten MB Quart® speakers and includes an 11,250-Lumen LED light bar.



▶ LOUD



HEAD UNIT

2882064	S4 Audio Roof
2882065	S8 Audio Roof
2882066	S10 Audio Roof

SPEAKERS



2882063	30.5 cm Subwoofer
---------	-------------------

HARNESSES

No additional harnesses required

BUSBAR HARNESS MAY BE REQUIRED. SEE RIGHT.

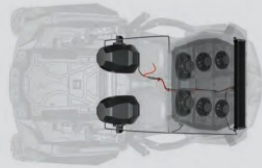

HEAD UNIT

2882064	S4 Audio Roof
2882065	S8 Audio Roof
2882066	S10 Audio Roof

SPEAKERS



2883739	Extreme Audio Pods
---------	--------------------

HARNESSES

Rear Audio Harness included with Pod Kit

BUSBAR HARNESS MAY BE REQUIRED. SEE RIGHT.



HEAD UNIT

2882064	S4 Audio Roof
2882065	S8 Audio Roof
2882066	S10 Audio Roof

SPEAKERS



2881989	Door Speakers
2883738	Audio Amp

HARNESSES

2881652	Line Out Audio Harness
---------	------------------------

BUSBAR HARNESS MAY BE REQUIRED. SEE RIGHT.

BUSBAR HARNESS

Depending on your vehicle model, you may need to add a busbar harness and audio harness specific to your vehicle.

VEHICLE FITMENT	BUSBAR HARNESS
RZR RS1 '18-'19, XP TURBO '16, XP 1000 '16-'17, S 1000 '16-'19, 900 '16-'17, S 1000 '16-'19, 900 '16-'17	HARNESS NOT REQUIRED, INCLUDED ON MACHINE
XP TURBO '16, XP 1000 '16-'17, S 1000 '16-'19, 900 '16-'17, S 1000 '16-'19, 900 '16-'17	2881551
XP 1000 '14-'15, 900 '15, 900 '16-'17	2882862
XP 4 TURBO '16, XP 4 1000 '16-'17, 4 900 '18, S4 1000 '19	2881646
XP 4 1000 '14-'15, 4 900 '14-'15	2882861

Y-AUDIO HARNESS



• Y-Harness splits the audio signal to allow for additional audio components to be added

» 2883269

LINE OUT AUDIO HARNESS



• Harness designed to extend JST audio signal. Use to run JST audio signal from rear of audio roof(s) to the front of the vehicle.

» 2881652

DASH RADIO

AUDIO SYSTEMS



LOUDEST

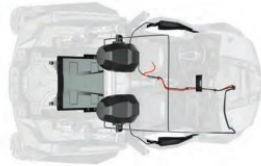

HEAD UNIT

2881988 Dash Radio*

SPEAKERS



2881989 Door Speakers
 2883116 Rear Door Speakers (4-seat add-on only)
 2883738 Audio Amp
 2883739 Extreme Audio Pods
 2882063 30.5 cm Subwoofer

HARNESSES

2883269 Y-Audio Harness (x2)
 Rear Audio Harness included with Pod Kit

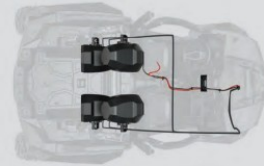

HEAD UNIT

2881988 Dash Radio*

SPEAKERS



2883739 Extreme Audio Pods
 2883739 Extreme Audio Pods

HARNESSES

2883269 Y-Audio Harness (x2)
 Rear Audio Harness included with Pod Kit

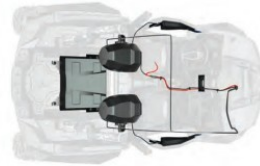

HEAD UNIT

2881988 Dash Radio*

SPEAKERS



2881989 Door Speakers
 2883116 Rear Door Speakers (4-seat add-on only)
 2883738 Audio Amp
 2882063 30.5 cm Subwoofer

HARNESSES

2883269 Y-Audio Harness

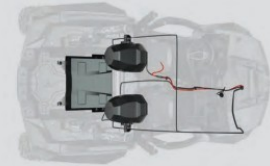

HEAD UNIT

2881988 Dash Radio*

SPEAKERS



2883739 Extreme Audio Pods
 2882063 30.5 cm Subwoofer

HARNESSES

2883269 Y-Audio Harness
 Rear Audio Harness included with Pod Kit

BUSBAR HARNESS MAY BE REQUIRED. SEE RIGHT.

BUSBAR HARNESS MAY BE REQUIRED. SEE RIGHT.

BUSBAR HARNESS MAY BE REQUIRED. SEE RIGHT.

BUSBAR HARNESS MAY BE REQUIRED. SEE RIGHT.

- A seamlessly integrated source unit to control all your audio needs

- Bluetooth connectivity
- Easy installation and great fit and finish

- Remote-mounted USB / 3.5mm plug for external device connection



▶ LOUD

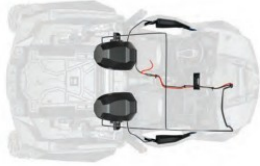

HEAD UNIT

2881988 Dash Radio*

SPEAKERS



2881989 Door Speakers
 2883116 Rear Door Speakers (4-seat add-on only)
 2883738 Audio Amp
 2883739 Extreme Audio Pods

HARNESSES

2883269 Y-Audio Harness
 Rear Audio Harness included with Pod Kit

BUSBAR HARNESS MAY BE REQUIRED. SEE RIGHT.

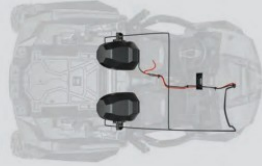

HEAD UNIT

2881988 Dash Radio*

SPEAKERS



2883739 Extreme Audio Pods

HARNESSES

Rear Audio Harness included with Pod Kit

BUSBAR HARNESS MAY BE REQUIRED. SEE RIGHT.



HEAD UNIT

2881988 Dash Radio*

SPEAKERS



2881989 Door Speakers
 2883116 Rear Door Speakers (4-seat add-on only)
 2883738 Audio Amp

HARNESSES

Included with Speaker Kit

BUSBAR HARNESS MAY BE REQUIRED. SEE RIGHT.

BUSBAR HARNESS

Depending on your vehicle model, you may need to add a busbar harness and audio harness specific to your vehicle.

VEHICLE FITMENT	BUSBAR HARNESS
RZR RS1 '18-'19, XP TURBO XP 4 TURBO '17-'19, XP 1000/XP 4 1000 '18-'19, XP TURBO S '18	HARNESS NOT REQUIRED, INCLUDED ON MACHINE
XP TURBO '16, XP 1000 '16-'17, S 1000 '16-'19, 900/S 900 '16-'19, 900 XC '16-'17	2881551
XP 1000 '14-'15, 900/S 900/900 XC '15	2882862
XP 4 TURBO '16, XP 4 1000 '16-'17, 4 900 '18, S4 1000 '19	2881646
XP 4 1000 '14-'15, 4 900 '14-'15	2882861

Y-AUDIO HARNESS



• Y-Harness splits the audio signal to allow for additional audio components to be added

» 2883269

RADIAL BLUETOOTH[®] REMOTE

AUDIO SYSTEMS



LOUDEST

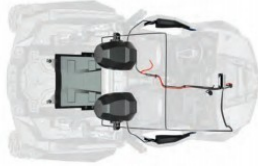

HEAD UNIT

2883113 Radial Bluetooth[®] Remote

SPEAKERS



2881989 Door Speakers
2883116 Rear Door Speakers (4-seat add-on only)
2883738 Audio Amp
2883739 Extreme Audio Pods
2882063 30.5 cm Subwoofer

HARNESSES

2883269 Y-Audio Harness
Rear Audio Harness included with Pod Kit

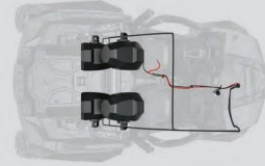

HEAD UNIT

2883113 Radial Bluetooth[®] Remote

SPEAKERS



2883739 Extreme Audio Pods
2883739 Extreme Audio Pods

HARNESSES

Rear Audio Harness included with Pod Kit



HEAD UNIT

2883113 Radial Bluetooth[®] Remote

SPEAKERS



2881989 Door Speakers
2883116 Rear Door Speakers (4-seat add-on only)
2883738 Audio Amp
2882063 30.5 cm Subwoofer

HARNESSES

No harness required

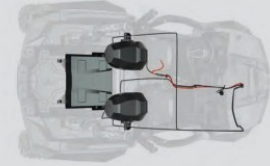

HEAD UNIT

2883113 Radial Bluetooth[®] Remote

SPEAKERS



2883739 Extreme Audio Pods
2882063 30.5 cm Subwoofer

HARNESSES

Rear Audio Harness included with Pod Kit

BUSBAR HARNESS MAY BE REQUIRED. SEE RIGHT.

BUSBAR HARNESS MAY BE REQUIRED. SEE RIGHT.

BUSBAR HARNESS MAY BE REQUIRED. SEE RIGHT.

BUSBAR HARNESS MAY BE REQUIRED. SEE RIGHT.

- Keep your phone stowed away and play your favorite tunes
- Mount in any open switch panel
- Control music via the easy to use joystick

- Turn the dial for volume control and toggle left/right or up/down for track selection
- Push dial for power and pause/play

- Bluetooth® 4.0 connectivity
- 3.5mm AUX jack for direct connection to music source

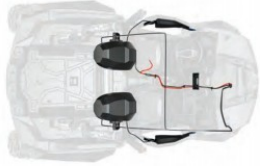
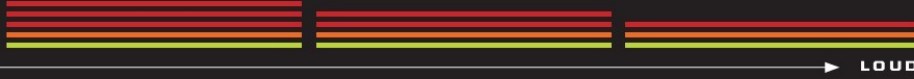

HEAD UNIT

2883113 Radial Bluetooth® Remote

SPEAKERS



2881989 Door Speakers
2883116 Rear Door Speakers (4-seat add-on only)
2883738 Audio Amp
2883739 Extreme Audio Pods

HARNESSES

Rear Audio Harness included with Pod Kit

BUSBAR HARNESS MAY BE REQUIRED. SEE RIGHT.

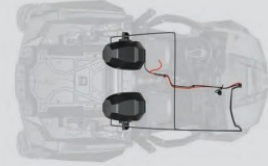

HEAD UNIT

2883113 Radial Bluetooth® Remote

SPEAKERS



2883739 Extreme Audio Pods

HARNESSES

Rear Audio Harness included with Pod Kit

BUSBAR HARNESS MAY BE REQUIRED. SEE RIGHT.

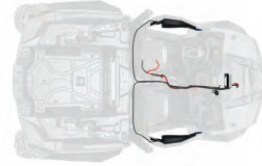

HEAD UNIT

2883113 Radial Bluetooth® Remote

SPEAKERS



2881989 Door Speakers
2883116 Rear Door Speakers (4-seat add-on only)
2883738 Audio Amp

HARNESSES

Included with Speaker Kit

BUSBAR HARNESS MAY BE REQUIRED. SEE RIGHT.

BUSBAR HARNESS

Depending on your vehicle model, you may need to add a busbar harness and audio harness specific to your vehicle.

VEHICLE FITMENT	BUSBAR HARNESS
RZR RS1 '18-'19, XP TURBO XP 4 TURBO '17-'19, XP 1000/XP 4 1000 '18-'19, XP TURBO S '18	HARNESS NOT REQUIRED, INCLUDED ON MACHINE
XP TURBO '16, XP 1000 '16-'17, S 1000 '16-'19, 900/S 900 '16-'19, 900 XC '16-'17	2881551
XP 1000 '14-'15, 900/S 900/900 XC '15	2882862
XP 4 TURBO '16, XP 4 1000 '16-'17, 4 900 '18, S4 1000 '19	2881646
XP 4 1000 '14-'15, 4 900 '14-'15	2882861

Y-AUDIO HARNESS



- Y-Harness splits the audio signal to allow for additional audio components to be added

» 2883269

PRO ARMOR®



Pro Armor tires are developed and tested with Polaris engineers ensuring the perfect fit and optimal performance.

2 WAYS TO
PURCHASE

INDIVIDUAL WHEELS & TIRES
- OR -
COMPLETE SETS

DOMINATE ANY ENVIRONMENT

TRAIL

P. 36

DUNES

P. 38



ACCESSORIES

RZR XP TURBO S

LIGHTING

RIDE COMMAND
& AUDIO

WHEELS & TIRES

CAGES & ROOFS

BUMPERS &
PROTECTION

DOORS & WINDSHIELD/
REAR PANELS

STORAGE & COCKPIT
ACCESSORIES

COOLERS, WINCHES,
PLOWES & MISC.

CHECK OUT THE FOLLOWING PAGES TO FIND YOURS

DESERT



P. 40

MUD



P. 42

PRO ARMOR®

Each wheel and tire Pro Armor designs for off-road vehicles performs perfectly in the intended environment for its intended use. Developed, tested, and produced in partnership so you can tackle the terrain ahead with Polaris.

8 OR 10-PLY RATED

- Pro Armor builds the toughest tires
- Higher ply ratings mean added protection

INNOVATION

DUAL-DUROMETER LUGS (Crawler XG & Attack 2.0)

- Firm durometer rubber on base of lug for stability
- Soft durometer rubber on top of lug for sticky grip

DUAL COMPOUND TREAD (Dual-Threat)

- Firm durometer rubber on center of tread for long wear life
- Soft durometer rubber on shoulders of tread for superior grip

TIRE: **DUAL-THREAT**

KNOW YOUR TIRES

DIMENSIONS
28" x 9" R14
TIRE HEIGHT | TIRE WIDTH | WHEEL DIAMETER

TREAD DEPTH
Deeper tread = more grip in all conditions

PADDLE DEPTH
Increases grip and performance in the sand

WEIGHT
A lighter tire makes for improved vehicle performance

SIDEWALL BELTS
Increase your resistance to sidewall punctures

PLY RATING
Indicates the puncture-resistance of a tire

LOAD RATING
Tires with higher load ratings can handle more weight

TIRES



TRIPLE-BELTED SIDEWALLS

- Sidewalls are the most vulnerable puncture area of any off-road tire
- Pro Armor makes tires with extra protection exactly where it's needed most - the sidewall

Sidewall puncture force vs. competition independently tested at Smithers Rapra (smithers.com). The results speak for themselves.

PRO ARMOR ATTACK	157.4 kg
MAXXIS® BIGHORN 2.0	73.5 kg
MAXXIS® BIGHORN	68 kg

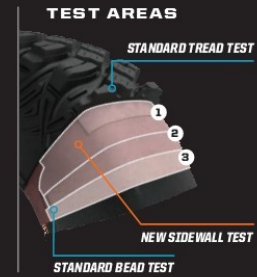

TORTURE-TESTED TOUGH SIDEWALLS

4,828+ km RATED

Pile on the kilometers with Pro Armor tires. Every tire is designed and constructed with longevity in mind. With ratings of 4,828 km and beyond, you are assured long life and performance.

WHEEL: **BUCKLE ACCENT**

KNOW YOUR TERRAIN



- Tread patterns optimized for extreme traction
- Ideal for both hard pack and loose trail



- Flexible "grippy" tread
- Aggressive side bite



- Provides traction and durability
- Built to perform in hard sand, jagged rocks or any other extreme terrain



- Extra deep treads
- Self-cleaning lugs



- Paddles provide traction and durability in soft sand
- Built to float on top of sand



- Industry leading anti-puncture side walls
- Purpose-built, long lasting tread patterns



- Handles extreme cold
- Holds shape and provides traction



BACKCOUNTRY



FRONT/REAR

PRO ARMOR ATTACK 2.0

- Engineered for excellent hard-pack performance
- Dual-compound technology and radial construction offer performance in all terrains
- Tight thread pattern for quieter ride

		TREAD DEPTH	TIRE WEIGHT	PLY RATING	SIDEWALL BELTS	LOAD RATING	
15"	28" x 10" R15 541.6344	FRONT/ REAR	25mm	15 kg	8	3	504 kg
15"	30" x 10" R15 541.6345						560 kg



WHEEL SIZE

15"

ATTACK 2.0 VS. ATTACK

TIGHTER TREAD PATTERN =
Better traction in hard pack

DUAL-DUROMETER LUG =
Increased grip & traction
in rough terrain, smoother
ride in all terrain

10-PLY RATED =
Increased durability

LARGER SIZE OFFERING IN 28" =
More ground clearance
& trail traction



FRONT/REAR

PRO ARMOR ATTACK

- The best all-purpose tire for all-season traction in any terrain
- Unique, full-face tread design
- Harder durometer lugs promote extended wear, increasing tire life
- Wider spaced lugs provide more grip in softer terrain

		TREAD DEPTH	TIRE WEIGHT	PLY RATING	SIDEWALL BELTS	LOAD RATING	
14"	26" x 9" R14 541.6613	FRONT	23mm	13 kg	8	3	413 kg
14"	26" x 11" R14 541.6614						REAR



WHEEL SIZE

14"

RALLY AT THE MINES

“OVERLY IMPRESSED BY THE SIDE BITE IN THE TIGHT PARTS ON THE TRAIL...CONSTANT TRACTION”

- Jeff Parker Columbia, Missouri

**DUAL-COMPOUND =
MORE GRIP + LONGER LIFE**

Firmer
Durometer
Rubber =
Longer Life

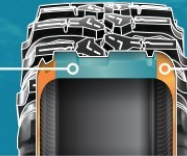

Softer
Durometer
Rubber =
More Grip

TRAIL



FRONT

REAR

PRO ARMOR DUAL-THREAT

- Dual-compound technology and radial construction offer performance in all terrains
- Softer durometer rubber on outer edge for overall superior grip and feel
- Harder durometer rubber in the middle for increased traction during acceleration and longer tread life

		TREAD DEPTH	TIRE WEIGHT	PLY RATING	SEDEWALL BELTS	LOAD RATING
14"	26" x 9" R14 5416340	FRONT	12 kg	10	3	413 kg
14"	26" x 11" R14 5416341	REAR	14 kg			504 kg
14"	29" x 9" R14 5416342	FRONT	14 kg	10	3	504 kg
14"	29" x 11" R14 5416343	REAR	16 kg			599 kg
15"	32" x 10" R15 5416753	FRONT/ REAR	19 kg			599 kg



WHEEL SIZE



FRONT/REAR

PRO ARMOR HAMMER

- Tame the roughest trail and high desert conditions with this multi-terrain tire
- High-durometer compound withstands high temperatures and abusive environments

		TREAD DEPTH	TIRE WEIGHT	PLY RATING	SEDEWALL BELTS	LOAD RATING	
15"	30" x 9.5" R15 5415615	FRONT/ REAR	20mm	16 kg	8	3	599 kg



WHEEL SIZE



ACCESSORIES

RZR XP TURBO S
& RZR RS1

LIGHTING

RIDE COMMAND
& AUDIO

WHEELS & TIRES

CAGES & ROOFS

BUMPERS &
PROTECTION

DOORS & WINDSHIELD/
REAR PANELS

STORAGE & COCKPIT
ACCESSORIES

COOLERS, WINCHES,
PLOW & MISC.



DUNES



FRONT

REAR

PRO ARMOR DUNES

- 28" flotation across the dunes
- Lightweight 12-paddle rear tires tout a flexible sidewall for flotation and acceleration
- 3-tiered front tire design delivers hard-turning bite and straight-line tracking

			TREAD DEPTH	TIRE WEIGHT	PLY RATING	SIDEWALL BELTS	LOAD RATING
14"	28" x 9" R14 5416533	FRONT	12.8mm	9 kg	8	2	288 kg
14"	28" x 11" R14 5416534	REAR	31mm	9 kg			438 kg



12 PADDLES
Best for RZR 900





“THESE SAND TIRES MAKE DUNE RIDING AMAZING. YOU CAN GET UP AND GO.”

- Julio Becerra Paris, CA



FRONT

REAR

PRO ARMOR SAND

- 30" and 16 paddles optimized to carve up the biggest dunes
- 16 paddles directly deliver the HP to the sand for high-performance dune riding
- Unique 3-tiered front tire design delivers hard-turning bite and straight-line tracking
- Lightweight and flexible sidewalls ensure full contact with the sand in the rear

		TREAD DEPTH	TIRE WEIGHT	PLY RATING	SIDEWALL BELTS	LOAD RATING
14"	30" x 11" R14 5415251	FRONT	12.8mm	10 kg	8	388 kg
					2	
14"	30" x 14" R14 5416252	REAR	31mm	15 kg	8	499 kg

16 PADDLES

Best for RZR XP Turbo/XP 1000



WHEEL SIZE

14"



DESERT RACE



FRONT/REAR

PRO ARMOR CRAWLER XR

- Wanna race? This tire grips it all, from the trail to the rocks
- Square block profile for even surface contact
- A tougher durometer than the XG to take on the toughest the trail has to offer

		TREAD DEPTH	TIRE WEIGHT	PLY RATING	SIDEWALL BELTS	LOAD RATING
14"	28" x 10" R14 5415636	FRONT/ REAR 16mm	15 kg	8	3	517 kg
15"	32" x 10" R15 5416114		18 kg			630 kg



WHEEL SIZE



WHAT CRAWLER ARE YOU?

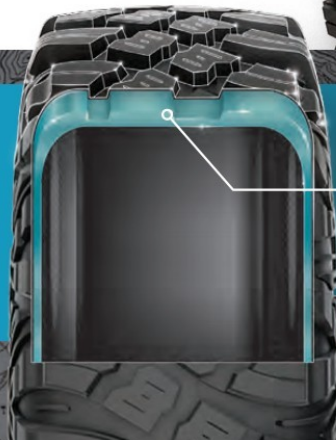

XR SINGLE DUROMETER

- Smaller lug height and single durometer gives this high-speed tire added rigidity and lateral stability when cornering
- Unique lug design excels in hard-packed, fast terrain



“THESE TIRES WERE FLAWLESS. AT HIGH SPEEDS, THE CRAWLER XG RUNS TRUE AND FEELS LIKE A Z-RATED SPORTS CAR TIRE. IN THE ROCKS, THESE TIRES LIVE UP TO THEIR NAME. CLIMBING LIKE A MOUNTAIN GOAT WITH RUBBER HOOF.”

- RZRLife.com on testing Pro Armor Crawler XG's at King Of Hammers

ROCK



FRONT/REAR

PRO ARMOR CRAWLER XG

- Big or small, these tires crawl them all
- A soft, sticky compound makes this tire ideal for both rock crawling and desert running
- 8-ply, triple-belted ballistic sidewalls resist punctures

		TREAD DEPTH	TIRE WEIGHT	PLY RATING	SEWALL BELTS	LOAD RATING
14"	30" x 10" R14 5415616	FRONT/ REAR 20mm	17 kg	8	3	581 kg
14"	32" x 10" R14 5416113		19 kg			644 kg
15"	28" x 10" R15 5416346		15 kg			499 kg
15"	30" x 10" R15 5416397		18 kg			581 kg
16"	NEW 32" x 10.5" R16 5416401		20 kg			644 kg



WHEEL SIZE

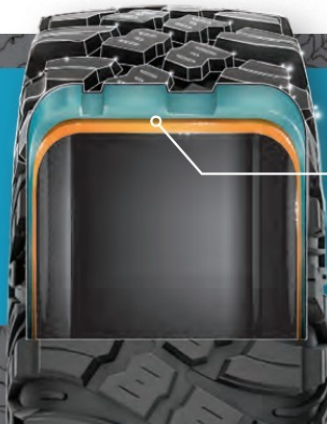

XG DUAL-DUROMETER

- Taller lug height and dual-durometer construction
- Perfect balance between high-speed performance, durability and flex in order to grip slick rock



MUD



FRONT/REAR

PRO ARMOR ANARCHY

- Take on any mud pit with the Mud Master
- Ultra deep lugs for maximum mud traction
- Deep, evenly spaced out lugs help channel the muck out so you can keep going

		TREAD DEPTH	TIRE WEIGHT	PLY RATING	SIDEWALL BELTS	LOAD RATING	
14"	29.5" x 9" R14 5415535	FRONT/ REAR	52mm	18 kg	8	3	499 kg

**SELF
CLEANING
AREAS**



WHEEL SIZE

14"



FRONT

REAR

PRO ARMOR DAGGER

- From the trails to the pits, this tire gets you through it all
- Deep, self-cleaning lugs and wide tire design for exceptional mud pit performance
- Rounded profile and full lug pattern for on-trail comfort

		TREAD DEPTH	TIRE WEIGHT	PLY RATING	SIDEWALL BELTS	LOAD RATING
14"	27" x 9" R14 5415617	FRONT	38mm	8	3	499 kg
14"	27" x 11" R14 5415618	REAR				531 kg

**SELF
CLEANING
AREAS**

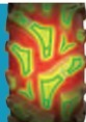

WHEEL SIZE

14"



DIESELSellerz

“...TIRES ARE UNSTOPPABLE IN SNOW.”

- Heavy D. dieselsellerz.com

SNOW



FRONT/REAR

PRO ARMOR WHITEOUT

- Extra wide tires for flotation in snow
- Cross-hatched tread pattern designed for superior snow traction with limited digging
- 2-ply sidewall designed to balloon for maximum use of its 15" wide contact patch

		TREAD DEPTH	TIRE WEIGHT	PLY RATING	SIDEWALL BELTS	LOAD RATING
14"	27" x 14" R14 5416032	FRONT/ REAR	17mm	21 kg	2	2
15"	30" x 15" R15 5416995					



WHEEL SIZE
14" 15"



MORE SURFACE AREA FOR BETTER FLOTATION ON SNOW

Snow-specific tire for trails and deep powder. Features an extra wide, bias-ply construction that can run at low pressures for maximum flexibility. High-flotation performance maintains critical vehicle ground clearance in the snow.

A



BEADLOCK INCLUDED

B



C



D



BEADLOCK INCLUDED

E



BEADLOCK REQUIRED

F



G



16"

15"

A REVOLVER **NEW** (BEADLOCK RINGS INCLUDED)

FRONT/REAR: Weight: 8.6 kg
Load Rating: 726 kg / Offset: -38

ACCENT: FRONT/REAR 15" x 7" 1523286
MATTE BLACK: FRONT/REAR 15" x 7" 1523285

B CYCLONE

FRONT/REAR: Weight: 7.8 kg
Load Rating: 590 kg / Offset: +4

ACCENT: FRONT/REAR 15" x 7" 1523184-266
MATTE BLACK: FRONT/REAR 15" x 7" 1523184-458

C FLARE

FRONT/REAR: Weight: 8.1 kg
Load Rating: 590 kg / Offset: +4

ACCENT: FRONT/REAR 15" x 7" 1523102-266
MATTE BLACK: FRONT/REAR 15" x 7" 1523102-458

D HALO (BEADLOCK RINGS INCLUDED)

FRONT/REAR: Weight: 7.7 kg
Load Rating: 726 kg / Offset: -38

ACCENT: FRONT/REAR 14" x 7" 1523282
MATTE BLACK: FRONT/REAR 14" x 7" 1523266

E HEXLR (BEADLOCK RINGS SOLD SEPARATELY)

FRONT/REAR: Weight: 7.3 kg
Load Rating: 590 kg / Offset: -38

ACCENT: FRONT/REAR 15" x 7" 1522435-458

F WHITEOUT

FRONT/REAR: Weight: 6.6 kg
Load Rating: 363 kg / Offset: -5

MATTE BLACK: FRONT/REAR 15" x 10" 1523149-458

G WYDE

FRONT/REAR: Weight: 6.1 kg
Load Rating: 590 kg / Offset: +55

ACCENT: FRONT/REAR 15" x 7" 1522550-266
MATTE BLACK: FRONT/REAR 15" x 7" 1522550-458

LUG NUTS

○ LUG NUTS REQUIRED

12mm x 1.5 SPLINED LUG NUTS

16 LUG NUTS WITH WRENCH	XP TURBO S '18, XP 4 1000/ TURBO 14-19, XP 1000/ TURBO 14-19, S4 1000 EPS '19, S 900 EPS '19, S 900 '19, S 1000 EPS '19, S 1000 '16-19, 900 S '15-18, 900 EPS '19, 900 S '14-19, 4 900 '15-18, 1000 S '17-18	2879332
4 LUG NUTS WITHOUT WRENCH		2879331
SPLINED LUG WRENCH	XP TURBO S '18, XP 4 1000/ TURBO 14-19, XP 1000/ TURBO 14-19, S4 1000 EPS '19, S 900 EPS '19, S 900 '19, S 1000 EPS '19, S 1000 '16-19, SZR RST '19, SZR RST '18, 900 S '15-18, 900 EPS '19, 900 S '14-19, 4 900 '15-18, 1000 S '17-18	2204966

.95 cm - 24 HEX LUG NUTS

16 HEX LUG NUTS	570 '13-18	2877409
4 HEX LUG NUTS		2876754

REPLACEMENT CAPS

POLARIS CAPS

LUSTER	ALL WHEELS EXCEPT THRASHER, WYDE & HEXLR	1521509-410
MATTE BLACK		1521509-521
LUSTER	HEXLR	1522243-410
MATTE BLACK		1522243-458



PRO ARMOR CAPS

LUSTER	ALL WHEELS EXCEPT THRASHER, WYDE & HEXLR	5453209-410
MATTE BLACK		5453209-458
MATTE BLACK	WYDE & THRASHER	1523063-458
LUSTER	THRASHER & HEXLR	1523015-410
MATTE BLACK		1523015-458



WHEELS



H AMPLIFY

FRONT: Weight: 5.9 kg
Load Rating: 408.2 kg / Offset: -9

REAR: Weight: 6.4 kg
Load Rating: 590 kg / Offset: +4

ACCENT: FRONT 14" x 7" 1522956-266
REAR 14" x 8" 1522957-266

MATTE BLACK: FRONT 14" x 7" 1522956-458
REAR 14" x 8" 1522957-458

DOES NOT FIT RZR XP 1000/TURBO '18-19 AND XP 4 1000/TURBO '18-19

I BUCKLE

FRONT: Weight: 5.8 kg
Load Rating: 408.2 kg / Offset: +4

REAR: Weight: 6.1 kg
Load Rating: 590 kg / Offset: -9

ACCENT: FRONT 14" x 7" 1522544-266
REAR 14" x 8" 1522545-266

MATTE BLACK: FRONT 14" x 7" 1522544-458
REAR 14" x 8" 1522545-458

DOES NOT FIT RZR XP 1000/TURBO '18-19 AND XP 4 1000/TURBO '18-19

J COMBAT (BEADLOCK RINGS INCLUDED)

FRONT/REAR: Weight: 7.3 kg
Load Rating: 726 kg / Offset: +38

ACCENT: FRONT/REAR 14" x 7" 1523284

MATTE BLACK: FRONT/REAR 14" x 7" 1523283

DOES NOT FIT RZR XP 1000/TURBO '18-19 AND XP 4 1000/TURBO '18-19

K REBLR (BEADLOCK RINGS SOLD SEPARATELY)

FRONT: Weight: 5.9 kg
Load Rating: 408.2 kg / Offset: +4

REAR: Weight: 6.6 kg
Load Rating: 590 kg / Offset: -9

ACCENT: FRONT 14" x 7" 1522338-458
REAR 14" x 8" 1522339-458

L SHACKLE

FRONT: Weight: 5.9 kg
Load Rating: 408.2 kg / Offset: +4

REAR: Weight: 6.4 kg
Load Rating: 590 kg / Offset: -9

ACCENT: FRONT 14" x 7" 1522546-266
REAR 14" x 8" 1522547-266

MATTE BLACK: FRONT 14" x 7" 1522546-458
REAR 14" x 8" 1522547-458

M SIX'R

FRONT: Weight: 4.8 kg
Load Rating: 408.2 kg / Offset: +4

REAR: Weight: 5.7 kg
Load Rating: 590 kg / Offset: -9

MATTE BLACK: FRONT 14" x 7" 1521507-521
REAR 14" x 8" 1521508-521

LUSTER: FRONT 14" x 7" 1521507-410
REAR 14" x 8" 1521508-410

N SPLIT

FRONT: Weight: 4.3 kg
Load Rating: 408.2 kg / Offset: +4

REAR: Weight: 4.9 kg
Load Rating: 590 kg / Offset: -9

MATTE BLACK: FRONT 14" x 6" 1522542-458
REAR 14" x 8" 1522543-458

FORGED BEADLOCK RINGS

14" BEADLOCK RINGS REBLR ONLY

VOODOO BLUE: 1522244-619

MACHINED: 1522244-266

WHITE: 1522244-133

INDY RED: 1522244-293

ORANGE CRUSH: 1522244-589

HALO REPLACEMENT (MATTE BLACK): 1523146-458

15" BEADLOCK RINGS HEXLR ONLY

VOODOO BLUE: 1522240-619

MACHINED: 1522240-266

WHITE: 1522240-133

INDY RED: 1522240-293

ORANGE CRUSH: 1522240-589

COMBAT REPLACEMENT (MATTE BLACK): 1523147-458



WHEEL & TIRE SETS

14"

BACKCOUNTRY/TRAIL

ROCK/RACE

	DUAL-THREAT 26" ALL RZR	DUAL-THREAT 29" RZR XP 1000/TURBO	ATTACK 26" ALL RZR	CRAWLER XG 30" RZR XP 1000/TURBO	CRAWLER XG 32" XP 4 1000/ TURBO 14-18	CRAWLER XR 28" ALL RZR EXCEPT 570 & 900/900 EPS
AMPLIFY <i>Accent</i> DOES NOT FIT RZR XP 1000/TURBO 18-19	2883138	2883146	2882390	2882396	2882452	2882394
AMPLIFY <i>Matte Black</i> DOES NOT FIT RZR XP 1000/TURBO 18-19	2883139	2883147	2882391	2882397	2882451	2882395
BUCKLE <i>Accent</i> DOES NOT FIT RZR XP 1000/TURBO 18-19	2883140	2883148	2881335	2881560	2882448	2881343
BUCKLE <i>Matte Black</i> DOES NOT FIT RZR XP 1000/TURBO 18-19	2883141	2883149	2881336	2881561	2882447	2881344
COMBAT <i>Accent</i> BEADLOCKS PRE-MOUNTED DOES NOT FIT RZR XP 1000/TURBO 18-19	2883217	2883219		2883211	2883215	2883213
COMBAT <i>Matte Black</i> BEADLOCKS PRE-MOUNTED DOES NOT FIT RZR XP 1000/TURBO 18-19	2883216	2883218		2883210	2883214	2883212
REBLR <i>Matte Black</i> BEADLOCKS SOLD SEPARATELY			2881381	2881382	2881382	2881386
SHACKLE <i>Accent</i>	2883142	2883150	2881347	2881558	2882450	2881355
SHACKLE <i>Matte Black</i>	2883143	2883151	2881348	2881559	2882449	2881356
SIX'R <i>Luster</i>			2881359	2881564		2881371
SIX'R <i>Matte Black</i>	2883144	2883152	2881360	2881563	2882453	2881372
SPLIT <i>Matte Black</i>	2883145	2883153	2881404			

15"

BACKCOUNTRY/TRAIL

ROCK/RACE

	HAMMER 30" RZR XP 1000/TURBO	ATTACK 2.0 28" ALL RZR EXCEPT 570 & 900/900 EPS	ATTACK 2.0 30" RZR XP 1000/TURBO	CRAWLER XG 28" ALL RZR EXCEPT 570 & 900/900 EPS	CRAWLER XG 30" RZR XP 1000/TURBO	CRAWLER XR 32" 626 XP 1000/TURBO
CYCLONE <i>Accent</i>	2883200	2883160	2883169	2883188	2883179	2883194
CYCLONE <i>Matte Black</i>	2883199	2883159	2883168	2883187	2883178	2883193
FLARE <i>Accent</i>	2883198	2883158	2883167	2883186	2883177	2883192
FLARE <i>Matte Black</i>	2883197	2883157	2883166	2883185	2883176	2883191
HALO <i>Accent</i> BEADLOCKS PRE-MOUNTED	2883202	2883162	2883171	2883190	2883181	2883196
HALO <i>Matte Black</i> BEADLOCKS PRE-MOUNTED	2883201	2883161	2883170	2883189	2883180	2883195
HEXLR <i>Matte Black</i> BEADLOCKS SOLD SEPARATELY	2881388	2883154	2883163	2883182	2883173	2882444
WYDE ACCENT BEADLOCKS SOLD SEPARATELY	2881402	2883156	2883165	2883184	2883175	2882446
WYDE <i>Matte Black</i> BEADLOCKS SOLD SEPARATELY	2881403	2883155	2883164	2883183	2883174	2882445

VALVES

COLBY SHORT ULTIMATE VALVE (2 PACK)

» 2883292



COLBY EMERGENCY VALVE (2 PACK)

» 2883293



COLBY COMBO VALVE KIT (16 PACK)

• Includes 8 Ultimate valves and 8 Emergency valves

» 2883294



ALL VALVES FIT XP TURBO S 18, XP 4 1000/TURBO 14-19, XP 1000/TURBO 14-19, S4 1000 EPS 19, S 900 EPS 19, S 900 19, S 1000 EPS 19, S 1000 16-19, 900 S 15-18, 900 EPS 19, 900 14-19, 570 13-18, 4 900 15-18, 1000 S 17-18

MUD

ANARCHY 29.5"
RZR XP
1000 TURBO



DAGGER 27"
ALL RZR



DUNES

DUNE 28"
ALL RZR
EXCEPT S70 &
900/900 EPS



SAND 30"
RZR XP
1000/
TURBO



UTILITY

HARVESTER 27"
ALL RZR
EXCEPT S70 &
900/900 EPS



HARVESTER 28"
ALL RZR
EXCEPT S70 &
900/900 EPS



PRESERVE 27"
ALL RZR
EXCEPT S70 &
900/900 EPS



2882402	2882392	2882400	2882398	2882388	2883225	2883208
2882403	2882393	2882401	2882399	2882389	2883226	2883209
2881341	2881337	2881345	2881339	2882383	2883220	2883203
2881342	2881338	2881346	2881340	2882384	2883221	2883204
	2881383	2881387	2881384			
2881353	2881349	2881357	2881351	2882385	2883222	2883205
2881354	2881350	2881358	2881352	2882386	2883223	2883206
	2881362		2881365			
2881369	2881363	2881375	2881366	2882387	2883224	2883207
	2881405	2881407	2881406			



SNOW

WHITEDOUT 30"
RZR XP
1000 TURBO



WHITEDOUT R15
Matte Black



2883172



ROCK/RACE

NEW

CRAWLER XG 32"
RZR XP
1000 TURBO



REVOLVER Accent
BEADLOCKS PRE-MOUNTED

2883703

REVOLVER Matte Black
BEADLOCKS PRE-MOUNTED

2883702

LUG NUTS REQUIRED
SEE P. 44-45 FOR CAPS,
BEADLOCK RINGS & LUG NUTS

PRO ARMOR



TIRE: **DUAL-THREAT**
WHEEL: **HALO - MATTE BLACK**

PERFORMANCE / CLEARANCE



FRONT SWAY BAR KIT

» 2881205-458
XP 4 1000 TURBO 16-19, XP 1000 TURBO 16-19
DOES NOT WORK WITH HIGH CLEARANCE A-ARMS

KEEP A LOW PROFILE

7.6 cm
LOWER
THAN STOCK

(XP 1000/Turbo)

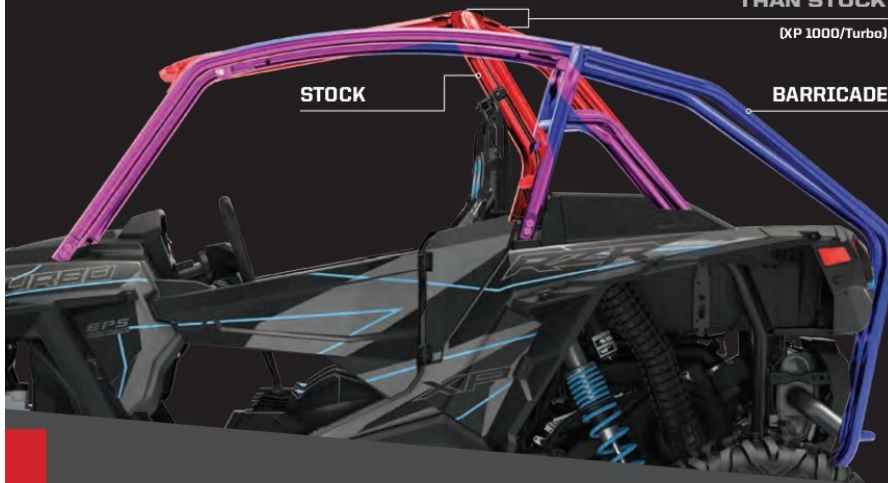

STOCK

BARRICADE

NO MODIFICATIONS NEEDED FOR INSTALLATION.

Add a custom look that sets you apart from the crowd. This custom cage offers all the safety standards and accessory mounting locations you need, but with a completely new look for your RZR. Add even more customization with a rear plate and a roof.

FULL ROHVA COMPLIANCE

The Barricade Cage System meets ANSI/ROHVA 2016-1 ROPS standards, developed and tested by the Recreational Off-Highway Vehicle Association®. Visit rohva.org for more information.

Recreational Off-Highway Vehicle Association® is a registered trademark of Recreational Off-Highway Vehicle Association.

BARRICADE CAGE SYSTEM WITH EXTENSION

• Includes Cage 2881986-458 and Extension 2882171-458

» 2882558-458

XP 1000/TURBO 14-18

CAGE

- ROHVA-compliant, single-piece, fully-welded roll cage
- 7.6 cm lower profile than stock cage for true custom look
- High-quality powdercoat and E-coat finish
- Works with Polaris Poly Half Windshield

BLACK 2881986-458

XP TURBO S '18, XP 1000/TURBO '15-19

EXTENSION

- High-quality powdercoat and E-coat finish
- Integrated tie-down bar
- Easy installation

BLACK 2882171-458

XP 1000/TURBO '14-18

ROOF

- Protect yourself from the elements while adding style and color to your custom cage
- Easy installation with integrated fastening points
- High-quality powdercoated finish
- Lightweight aluminum

BRIGHT WHITE 2882172-133

INDY RED 2882172-293

BLACK 2882172-458

LIME SQUEEZE 2882172-630

VELOCITY BLUE 2882172-689

XP TURBO S '18, XP 1000/TURBO 14-19

REAR PLATE

- Precision cut and formed from a rugged steel plate
- Attaches quickly and easily to integrated fastening points

BRIGHT WHITE 2882173-133

INDY RED 2882173-293

BLACK 2882173-458

LIME SQUEEZE 2882173-630

VELOCITY BLUE 2882173-689

XP 1000/TURBO '14-18



ACCESSORIES

RZR XP TURBO S

LIGHTING

RIDE COMMAND
& AUDIO

WHEELS & TIRES

CAGES & ROOFS

BUMPERS &
PROTECTION

DOORS & WINDSHIELD/
REAR PANELS

STORAGE & COCKPIT
ACCESSORIES

COOLERS, WINCHES,
PLOWES & MISC.



POLY

LOCK & RIDE

POLY SPORT ROOF TOP SELLER

- Rigid injection-molded design to eliminate warping in high-heat conditions
- Integrated mounting locations for lighting
- Rugged, textured polyethylene construction for impact and abrasion resistance

GRAPHIC SPORT ROOF

- Weighs only 5 kg (30% lighter than aluminum)
- Won't bend or break upon impact with debris or other obstacles
- Sunroof lets in sunlight while keeping you shaded from the heat

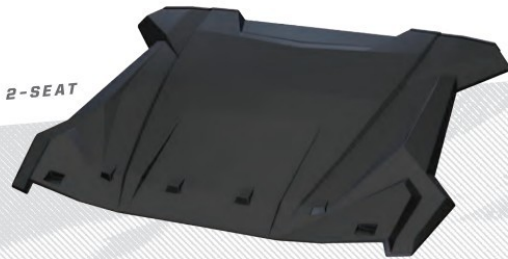

COLOR	2-SEAT	4-SEAT
■ BLACK	2883073	2883074
	XP 1000/TURBO '14-19, S 900 EPS '19, S 900 '19, S 1000 EPS '19, S 1000 '16-19, 900 S '15-18, 900 EPS '19, 900 '15-19, 1000 S '17-18	XP 4 1000/TURBO '14-19, S4 1000 EPS '19, 4 900 '15-18

COLOR	2-SEAT	4-SEAT
■ BLACK	2881206	2881935
■ INDY RED	2881607	2881936
□ BRIGHT WHITE	2881608	2881937
	XP 1000/TURBO '14-19, S 900 EPS '19, S 900 '19, S 1000 EPS '19, S 1000 '16-19, 900 S '15-18, 900 EPS '19, 900 '14-19, 1000 S '17-18	XP 4 1000/TURBO '14-19, S4 1000 EPS '19, 4 900 '15-18



EVERY POLARIS ROOF IS ENGINEERED IN TANDEM WITH YOUR RZR to guarantee the best fit, finish and style in the industry. A roof is essential for keeping the elements at bay while you ride your favorite trails in comfort.

ALUMINUM

ALUMINUM ROOF

- Seals to the vehicle frame for the best protection and great integration with other RZR accessories
- Strong and durable 5051 aluminum construction for long-lasting, reliable protection

2-SEAT



CANVAS

CANVAS ROOF

- Durable, heavyweight 652 g polyester canvas construction
- Mold-resistant and UV-stable to resist fading for long-lasting performance
- Installs quickly and easily with provided straps

2-SEAT

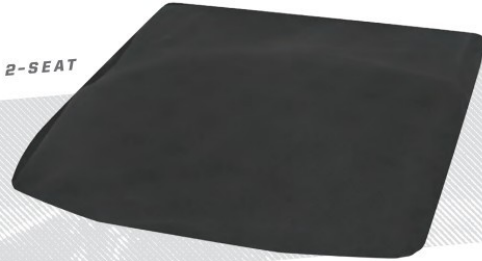

COLOR	2-SEAT	4-SEAT
BLACK	2881582-458	2881592-458
LIME SQUEEZE	2881582-630	2881592-630
INDY RED	2881582-293	2881592-293
VELOCITY BLUE	2881582-689	2881592-689
SPECTRA ORANGE	2881582-446	2881592-446
BRIGHT WHITE	2881582-133	2881592-133

XP 1000/TURBO '14-19, S 900 EPS '19, S 900 '19, S 1000 EPS '19, S 1000 '16-19, 900 S '15-18, 900 EPS '19, 900 '14-19, 1000 S '17-18

XP 4 1000/TURBO '14-19, S4 1000 EPS '19, 4 900 '15-18

COLOR	2-SEAT	4-SEAT
BLACK	2880561	2880610

XP 1000/TURBO '14-19, S 900 EPS '19, S 900 '19, S 1000 EPS '19, S 1000 '16-19, 900 S '15-18, 900 EPS '19, 900 '14-19, 1000 S '17-18

XP 4 1000/TURBO '14-19, S4 1000 EPS '19, 4 900 '15-18

4-SEAT



4-SEAT



STAND GUARD

DESERT BUMPER **NEW**

Perfect for: **Heavy-duty protection with aggressive style and mounting for lights**

FRONT



4.4 cm **DIAMETER**
STEEL TUBE CONSTRUCTION

REAR



FALL AVAILABILITY		
COLOR	FRONT	REAR
BLACK	2884019-458	2884020-458
INDY RED	2884019-293	2884020-293
TITANIUM METALLIC	2884019-632	2884020-632

XP 1000/TURBO '19, XP 4 1000/TURBO '19

COLOR	FRONT	REAR
BLACK	2883132-458	2883133-458

XP TURBO S '18

BULL BUMPERS

Perfect for: **Ultra light weight and minimalist look**

FRONT



3.8 cm x 5.1 cm
STEEL OVAL CONSTRUCTION

REAR



COLOR	FRONT	REAR
BLACK	2881202-458	2881472-458
LIME SQUEEZE	2881202-630	2881472-630
INDY RED	2881202-293	2881472-293
VELOCITY BLUE	2881202-689	2881472-689
SPECTRA ORANGE	2881202-446	2881472-446
BRIGHT WHITE	2881202-133	2881472-133

FRONT FITMENT: XP 4 1000/TURBO '14-18, XP 1000/TURBO '14-18, S4 1000 EPS '19, S 900 EPS '19, S 900 '19, S 1000 EPS '19, S 1000 '16-19, 900 S '15-18, 900 EPS '19, 900 '14-19, 4 900 '15-18, 1000 S '17-18

REAR FITMENT: XP 4 1000/TURBO '14-18, XP 1000/TURBO '14-18

LOW PROFILE BUMPERS

Perfect for: **More protection, integrated mounting locations for accessories**

FRONT



4.4 cm **DIAMETER**
STEEL TUBE CONSTRUCTION

REAR



COLOR	FRONT	REAR
BLACK	2879449-458	2880560-458
LIME SQUEEZE	2881583-630	2881589-630
INDY RED	2881583-293	2881589-293
VELOCITY BLUE	2881583-689	2881589-689
SPECTRA ORANGE	2881583-446	2881589-446
BRIGHT WHITE	2881583-133	2881589-133

FRONT FITMENT: XP 4 1000/TURBO '14-18, XP 1000/TURBO '14-18, S4 1000 EPS '19, S 900 EPS '19, S 900 '19, S 1000 EPS '19, S 1000 '16-19, 900 S '15-18, 900 EPS '19, 900 '14-19, 4 900 '15-18, 1000 S '17-18

REAR FITMENT: XP 4 1000/TURBO '14-18, XP 1000/TURBO '14-18



DELUXE BUMPERS TOP SELLER

Perfect for: **Maximum protection, integrated mounting points**



3.8 cm DIAMETER STEEL TUBE CONSTRUCTION

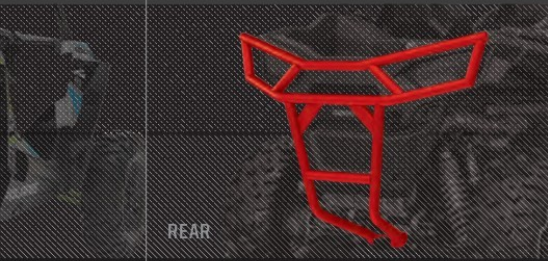

COLOR	FRONT	REAR
BLACK	2880166-458	2880164-458
LIME SQUEEZE	2881591-630	2881590-630
INDY RED	2881591-293	2881590-293
VELOCITY BLUE	2881591-689	2881590-689
SPECTRA ORANGE	2881591-446	2881590-446
BRIGHT WHITE	2881591-133	2881590-133

FRONT FITMENT: XP 4 1000/TURBO 14-18, XP 1000/TURBO 14-18, S4 1000 EPS 19, S 900 EPS 19, S 900 19, S 1000 EPS 19, S 1000 16-19, 900 S 15-18, 900 EPS 19, 900 14-19, 4 900 15-18, 1000 S 17-18

REAR FITMENT: S 900 EPS 19, S 900 19, S 1000 EPS 19, S 1000 16-19, 900 S 15-18, 900 EPS 19, 900 14-19, 1000 S 17-18

EXTREME BUMPER ATTACHMENT

Perfect for: **Increased protection around lighting and fenders**



4.4 cm DIAMETER STEEL TUBE CONSTRUCTION



COLOR	FRONT	REAR
BLACK	2879451-458	2879452-458
LIME SQUEEZE	2881584-630	2881585-630
INDY RED	2881584-293	2881585-293
VELOCITY BLUE	2881584-689	2881585-689
SPECTRA ORANGE	2881584-446	2881585-446
BRIGHT WHITE	2881584-133	2881585-133

FRONT FITMENT: XP 4 1000/TURBO 14-18, XP 1000/TURBO 14-18, S4 1000 EPS 19, S 900 EPS 19, S 900 19, S 1000 EPS 19, S 1000 16-19, 900 S 15-18, 900 EPS 19, 900 14-19, 4 900 15-18, 1000 S 17-18

REQUIRES LOW PROFILE FRONT BUMPER

REAR FITMENT: XP 4 1000/TURBO 14-18, XP 1000/TURBO 14-18

REQUIRES LOW PROFILE REAR BUMPER

EXTREME DUTY BUMPER

Perfect for: **Full protection in the toughest terrain and riding conditions**



4.4 cm DIAMETER STEEL TUBE CONSTRUCTION



COLOR	FRONT
BLACK	2880479-458

XP 4 1000/TURBO 14-18, XP 1000/TURBO 14-18, S4 1000 EPS 19, S 900 EPS 19, S 900 19, S 1000 EPS 19, S 1000 16-19, 900 S 15-18, 900 EPS 19, 900 14-19, 4 900 15-18, 1000 S 17-18

DOES NOT FIT WITH ANY PLOW SYSTEM

ANCHOR MOUNTS

Tougher than conventional nuts and bolts, Expansion Anchor Mounts are engineered into every RZR, allowing for a fast install.

BUMPER ANCHOR PACK

- 4 anchors and 2 Bumper End Caps included

» 2205114



PROTECT YOUR RIDE

WHEN PUSHING LIMITS

in punishing off-road environments, keep your RZR protected from harsh hits and damage with an added layer of protection and peace of mind.

HMW FRONT A-ARM GUARDS

- » 2879454
XP 4 1000/TURBO '14-19, XP 1000/TURBO '14-19, RZR RS1T '19, RZR RS1 '18
- » 2880274
S4 1000 EPS '19, S 900 EPS '19, S 900 '19, S 1000 EPS '19, S 1000 '16-19, 900 S '15-18, 4 900 '15-18, 1000 S '17-18
- » 2880170
900 EPS '19, 900 '14-19

TOUGH .95 cm THICK DESIGN WITHSTANDS THE TOUGHEST IMPACTS

HMW SKID PLATE

- » 2-SEAT • 2880290
S 900 EPS '19, S 900 '19, S 1000 EPS '19, S 1000 '16-19, 900 S '15-18, 900 EPS '19, 900 '14-19, 1000 S '17-18
- » 2-SEAT • 2881615
XP 1000/TURBO '14-19
- » 4-SEAT • 2880291
S4 1000 EPS '19, 4 900 '15-18
- » 4-SEAT • 2881725
XP 4 1000/TURBO '14-19
TO FIT '14-15 ADAPTER BRACKET KIT 2206329 IS REQUIRED

CUSTOM CONTOURED FOR A PERFECT FIT TO RETAIN MAXIMUM GROUND CLEARANCE

HMW REAR TRAILING ARM GUARDS

- » 2879496
XP 4 1000/TURBO '14-19, XP 1000/TURBO '14-19, RZR RS1T '19, RZR RS1 '18

HMW REAR A-ARM GUARDS

- » 2880171
S4 1000 EPS '19, S 900 EPS '19, S 900 '19, S 1000 EPS '19, S 1000 '16-19, 900 S '15-18, 4 900 '15-18, 1000 S '17-18
- » 2880172
900 EPS '19, 900 '14-19



INTRUSION BAR

- » 2879181
XP 4 1000/TURBO '14-18, XP 1000/TURBO '14-18, S4 1000 EPS '19, S 900 EPS '19, S 900 '19, S 1000 EPS '19, S 1000 '16-19, 900 S '15-18, 900 EPS '19, 900 '14-19, 4 900 '15-18, 1000 S '17-18
WILL NOT WORK WITH ANY FULL WINDSHIELD.



BUMPER ADAPTER

- Connects the Upper Cab Frame Extension (2880411) with rear bumper, each sold separately

- » 2880165
S4 1000 EPS '19, S 900 EPS '19, S 900 '19, S 1000 EPS '19, S 1000 '16-19, 900 S '15-18, 900 EPS '19, 900 '14-19, 4 900 '15-18, 1000 S '17-18



REAR CAB FRAME EXTENSION

- » UPPER • 2880411
S 900 EPS '19, S 900 '19, S 1000 EPS '19, S 1000 '16-19, 900 S '15-18, 900 EPS '19, 900 '14-19, 1000 S '17-18



» LOWER • 2880412

LOW PROFILE ROCK SLIDERS - STEEL

• Plated steel construction, durable powdercoat finish

• Easy installation with expanded anchor mount

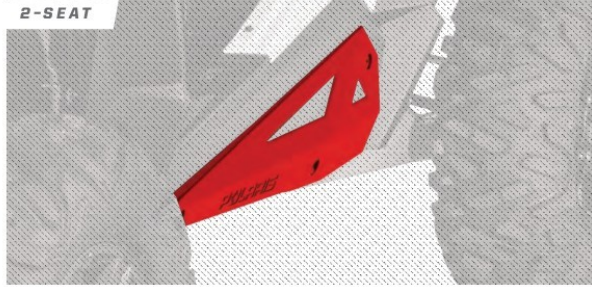

2-SEAT

LOW PROFILE: NO LOSS IN GROUND CLEARANCE

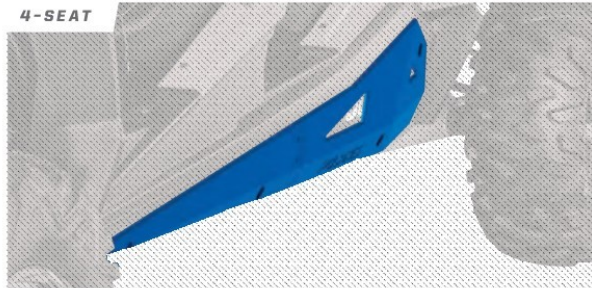

4-SEAT

COLOR	2-SEAT	4-SEAT
■ BLACK	2879498-458	2879940-458
■ LIME SQUEEZE	2881587-630	2881593-630
■ INDY RED	2881587-293	2881593-293
■ VELOCITY BLUE	2881587-689	2881593-689
■ SPECTRA ORANGE	2881587-446	2881593-446
□ BRIGHT WHITE	2881587-133	2881593-133

2-SEAT: XP TURBO S '18, XP 1000/TURBO '14-19, S 900 EPS '19, S 900 '19, S 1000 EPS '19, S 1000 '16-19, 900 S '15-18, 900 EPS '19, 900 '14-19, 1000 S '17-18
4-SEAT: XP 4 1000/TURBO '14-19, S4 1000 EPS '19, 4 900 '15-18

EXTREME KICK-OUT ROCK SLIDERS - STEEL

• Rugged steel protection and race-inspired styling

• Low-profile mounting location will not diminish ground clearance



2-SEAT

1 1/4" DIAMETER STEEL TUBE CONSTRUCTION



4-SEAT

COLOR	2-SEAT	4-SEAT
■ BLACK	2879456-458	2882079-458
■ LIME SQUEEZE	2881586-630	2882079-630
■ INDY RED	2881586-293	2882079-293
■ VELOCITY BLUE	2881586-689	2882079-689
■ SPECTRA ORANGE	2881586-446	2882079-446
□ BRIGHT WHITE	2881586-133	2882079-133

2-SEAT: XP TURBO S '18, XP 1000/TURBO '14-19, S 900 EPS '19, S 900 '19, S 1000 EPS '19, S 1000 '16-19, 900 S '15-18, 900 EPS '19, 900 '14-19, 1000 S '17-18
4-SEAT: XP 4 1000/TURBO '14-19, S4 1000 EPS '19, 4 900 '15-18



XXL FENDER FLARES (FRONT ONLY)

• Keep the mud, dirt, and debris from launching off the tires and into your face

• Includes 2

» 2881985

XP 4 1000/TURBO '14-19, XP 1000/TURBO '14-19, S4 1000 EPS '19, S 900 EPS '19, S 900 '19, S 1000 EPS '19, S 1000 '16-19, 900 S '15-18, 900 EPS '19, 900 '14-19, 4 900 '15-18, 1000 S '17-18



MUD FLAPS (FRONT ONLY)

• Includes 2

» 2879938

XP TURBO S '18, XP 4 1000/TURBO '14-19, XP 1000/TURBO '14-19, S4 1000 EPS '19, S 900 EPS '19, S 900 '19, S 1000 EPS '19, S 1000 '16-19, 900 S '15-18, 900 EPS '19, 900 '16-19, 4 900 '15-18, 1000 S '17-18

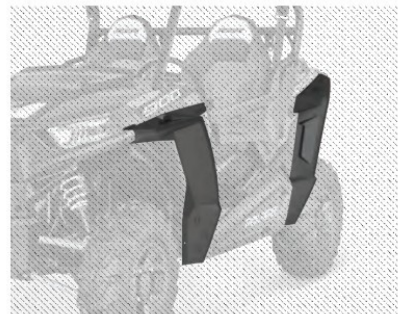

FENDER FLARE KIT

• Stock replacement for 900 Models

• Front & Rear Fender Flares (includes 4)

» 2879434

900 EPS '19, 900 '14-19



POLARIS ALUMINUM DOORS

- Single-piece stamped aluminum maximizes quality, fit and finish
- More cockpit room with wide berth
- Gasket design eliminates rattling and creates a firm seal
- Available with RZR-matched graphics

» 2-SEAT • 2879510

XP TURBO S '18, XP 1000/TURBO '14-19, S 900 EPS '19, S 900 '19, S 1000 EPS '19, S 1000 '18-19, 900 S '15-18, 1000 S '17-18

» 4-SEAT • 2879943

XP 4 1000/TURBO '14-19, S4 1000 EPS '19, 4 900 '15-18



POLARIS ALUMINUM DOOR GRAPHICS

COLOR	2-SEAT	4-SEAT	
XP 1000 BLACK PEARL	2884054	2884055	FALL AVAILABILITY
XP 1000 WHITE PEARL	2884056	2884057	FALL AVAILABILITY
TURBO TITANIUM METALLIC	2884058	2884059	FALL AVAILABILITY

XP1000/TURBO '19 & XP 4 1000/TURBO '19

TURBO VELOCITY BLUE	2883129	2883118
BLACK PEARL	2883131	2883130
TURBO BLACK PEARL	2883134	2883032

XP1000/TURBO '18 & XP 4 1000/TURBO '18

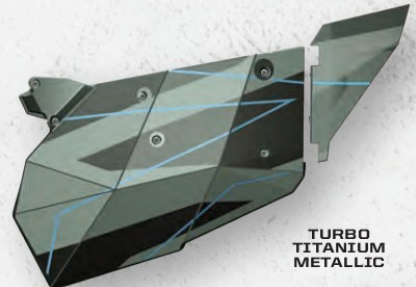
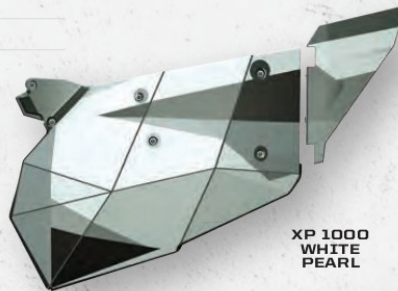



LOWER DOOR INSERTS

- Covers the bottom of the door opening, shutting out water and dust
- Durable plastic construction with steel frame

» 2-SEAT 2879509

XP TURBO S '18, XP 1000/TURBO
'14-19, S 900 EPS '19, S 900 '19, S
1000 EPS '19, S 1000 '16-19, 900 S
'15-18, 1000 S '17-18

» 2-SEAT 2880207

900 EPS '19, 900 '14-19

» 4-SEAT 2879942

XP 4 1000/TURBO '14-19, S4 1000
EPS '19, 4 900 '15-18

UPPER DOOR NETS

» 2881654

XP 1000/TURBO '14-19, S 900 EPS '19,
S 900 '19, S 1000 EPS '19, S 1000 '16-
19, 900 S '15-18, 1000 S '17-18



CANVAS UPPER HALF DOORS

» 2-SEAT • 2879902

XP 1000/TURBO '16-18, S 900 EPS '19, S 900
'19, S 1000 EPS '19, S 1000 '16-19, 900 S '15-18,
900 '16, 1000 S '17-18

» 2-SEAT • 2880609

900 EPS '19, 900 '14-19

» 4-SEAT • 2879946

XP 4 1000/TURBO '14-19, S4 1000 EPS '19,
4 900 '15-18





HARD COAT POLY



FLIP-DOWN WINDSHIELD - HARD COAT POLY

- Two-position design can be adjusted quickly without the use of tools
- Easy to install and made of tough polycarbonate with scratch-resistant hard coat

» 2881616

XP 4 1000/TURBO '14-18, XP 1000/TURBO '14-18, S4 1000 EPS '19, S 900 EPS '19, S 900 '19, S 1000 EPS '19, S 1000 '16-19, 900 S '15-18, 900 EPS '19, 900 '14-19, 4 900 '15-18, 1000 S '17-18
DOES NOT FIT RIDE COMMAND MODELS WITH ANTENNA

LOCK & RIDE

VENTED WINDSHIELD - HARD COAT POLY

- Impact-resistant polycarbonate and installs/removes in minutes without tools
- New vents allow for temperature regulation

» 2883111

XP 4 1000/TURBO '14-18, XP 1000/TURBO '14-18, S4 1000 EPS '19, S 900 EPS '19, S 900 '19, S 1000 EPS '19, S 1000 '16-19, 900 S '15-18, 900 EPS '19, 900 '15-19, 4 900 '15-18, 1000 S '17-18

LOCK & RIDE

FULL WINDSHIELD - HARD COAT POLY TOP SELLER

- Durable, optical-grade polycarbonate for maximum impact resistance
- Installs and removes quickly without tools

» 2884018 NEW SHOW

XP TURBO '19, XP 4 TURBO '19, XP 4 1000 '19, XP 1000 '19

» 2883110

XP 4 1000/TURBO '14-18, XP 1000/TURBO '14-18, S4 1000 EPS '19, S 900 EPS '19, S 900 '19, S 1000 EPS '19, S 1000 '16-19, 900 S '15-18, 900 EPS '19, 900 '15-19, 4 900 '15-18, 1000 S '17-18

LOCK & RIDE

HALF WINDSHIELD - HARD COAT POLY TOP SELLER

- Strong, durable, impact-resistant polycarbonate
- Installs quickly and easily without tools
- Fully-sealed lower section of windshield to hood

» 2883109

XP 4 1000/TURBO '14-18, XP 1000/TURBO '14-18, S4 1000 EPS '19, S 900 EPS '19, S 900 '19, S 1000 EPS '19, S 1000 '16-19, 900 S '15-18, 900 EPS '19, 900 '15-19, 4 900 '15-18, 1000 S '17-18

ADD A REAR PANEL TO REDUCE THE DUST SWIRL



POLARIS ENGINEERED ADVANTAGES



AIRTIGHT GASKET SEAL

Our windshields and rear panels feature 360° airtight gasket seals to keep drafts and moisture out of your cab.



LOCK & RIDE

REVOLUTIONARY INSTALLATION

Lock & Ride Cage Clamp allows for easy installation and easy removal of Polaris poly windshields, eliminating fear of cracked trim when tightening.

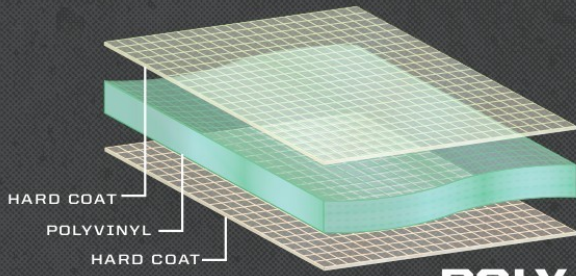

POLY

Lightweight and flexible, Poly is **IMPACT-RESISTANT**, providing long-term value and protection. Guarantees a **TIGHT SEAL** to keep out rain and dust. Hard Coat options feature an extra layer on both sides of the poly, which provides **30x MORE SCRATCH RESISTANCE** than regular poly windshields.

VS

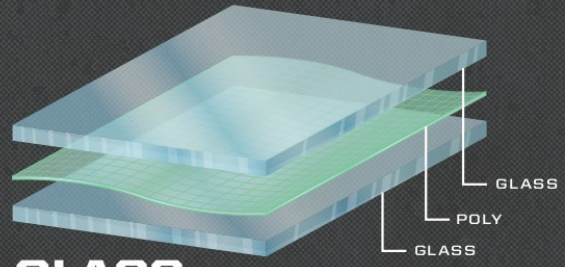

GLASS

Superior **OPTICAL CLARITY** for a clear view. Laminated safety glass **PROTECTS FROM SCRATCHES** and provides automotive-level visibility.

GLASS



LOCK & RIDE

HALF WINDSHIELD - HARD COAT TINTED POLY

- Enhanced curved styling prevents collecting mud or dirt
- Innovative tint technology helps reduce glare and improve visibility
- Installs and removes quickly with no tools
- Equipped with self-adjusting clamps

» 2883135

XP TURBO S '18, XP TURBO '19, XP 4 TURBO '19, XP 4 1000 '19, XP 1000 '19

VENTED WINDSHIELD - GLASS

- 7.6 cm vent opens and closes with one-handed operation—provides immediate vent-out and increased cabin airflow

» 2883112

XP 4 1000/TURBO '14-18, XP 1000/TURBO '14-18, S4 1000 EPS '19, S 900 EPS '19, S 900 '19, S 1000 EPS '19, S 1000 '16-19, 900 S '15-18, 900 EPS '19, 900 '15-19, 4 900 '15-18, 1000 S '17-18

GLASS WINDSHIELD

- Installs in minutes and integrates into a designated mounting position
- Laminated safety glass for excellent scratch resistance

» 2879447

XP 4 1000/TURBO '14-18, XP 1000/TURBO '14-18, S4 1000 EPS '19, S 900 EPS '19, S 900 '19, S 1000 EPS '19, S 1000 '16-19, 900 S '15-18, 900 EPS '19, 900 '14-19, 4 900 '15-18, 1000 S '17-18

WINDSHIELD WIPER SYSTEM

» 2879526

XP 4 1000 '14-19, XP 1000 '14-19, S4 1000 EPS '19, S 900 EPS '19, S 900 '19, S 1000 EPS '19, S 1000 '16-19, 900 S '15-18, 900 EPS '19, 900 '14-19, 4 900 '15-18, 1000 S '17-18

REAR PANELS



LOCK & RIDE

TOP SELLER

REAR PANEL - POLY

» 2881613

S4 1000 EPS '19, S 900 EPS '19, S 900 '19, S 1000 EPS '19, S 1000 '16-19, 900 S '15-18, 900 EPS '19, 900 '14-19, 4 900 '15-18, 1000 S '17-18

» 2881614

XP 4 1000/TURBO '14-19, XP 1000/TURBO '14-19

» 2878752

570 EPS '19, 570 '12-19

REAR PANEL - CANVAS

- 23 oz. polyester canvas is mold-resistant for long-term performance and UV-stable to resist fading

» 2880608

S4 1000 EPS '19, S 900 EPS '19, S 900 '19, S 1000 EPS '19, S 1000 '16-19, 900 S '15-18, 900 EPS '19, 900 '14-19, 4 900 '15-18, 1000 S '17-18

REAR PANEL - MESH

» 2880409

S4 1000 EPS '19, S 900 EPS '19, S 900 '19, S 1000 EPS '19, S 1000 '16-19, 900 S '15-18, 900 EPS '19, 900 '14-19, 4 900 '15-18, 1000 S '17-18

» 2879507

XP 4 1000/TURBO '14-19, XP 1000/TURBO '14-19

REAR RACE NET

» 2880408

S4 1000 EPS '19, S 900 EPS '19, S 900 '19, S 1000 EPS '19, S 1000 '16-19, 900 S '15-18, 900 EPS '19, 900 '14-19, 4 900 '15-18, 1000 S '17-18

» 2879936

XP 4 1000/TURBO '14-19, XP 1000/TURBO '14-19

BRING IT ALL STORE IT ALL

LOCK & RIDE

COOLER BOX

- One-piece rotomolded construction for extreme durability
- Lid locks securely in place with rubber latches to protect cargo
- Heavy-duty hinges and weatherproof seal block moisture and dust
- Keeps food and beverages cool for 48+ hours, depending on conditions
- UV-fade resistant
- Installs quickly and easily without tools
- Easy to carry with integrated grab handles

» 45.4 L
2881555

XP TURBO S '18, XP 4
1000/TURBO '14-19, XP
1000/TURBO '14-19

» 48.2 L
2881556

S4 1000 EPS '19, S 900
EPS '19, S 900 '19, S 1000
EPS '19, S 1000 '16-19,
900 S '15-18, 900 EPS '19,
900 '14-19, 4 900 '15-18,
1000 S '17-18



BED D-RINGS

» 2877460

XP TURBO S '18, XP 4 1000/
TURBO '14-19, XP 1000/TURBO
'14-19, S4 1000 EPS '19, S 900 EPS
'19, S 900 '19, S 1000 EPS '19, S
1000 '16-19, 900 S '15-18, 900 EPS
'19, 900 '14-19, 570 EPS '19, 570
'12-19, 4 900 '15-18, 1000 S '17-18



LOCK & RIDE D-RINGS

» 2881544

ALL RZR MODELS

LOCK & RIDE EXPANSION ANCHOR

» 2876420

ALL RZR MODELS

LOCK & RIDE

CARGO BOX

- Integrated rear cargo box touting 65 liters of storage
- Secure latching lid with taut rubber strap tie-downs
- Lightweight design integrates seamlessly with RZR Rear Cargo Bed
- Includes all mounting hardware for complete installation

» 2881193

XP TURBO S '18, XP 4 1000/TURBO '14-19, XP 1000/TURBO '14-19, S4 1000 EPS '19, S 900 EPS '19, S 900 '19, S 1000 EPS '19, S 1000 '16-19, 900 S '15-18, 900 EPS '19, 900 '14-19, 4 900 '15-18, 1000 S '17-18

UNDER-HOOD STORAGE BIN

- Perfect out of the way space for a tool kit, extra belt, tow straps corner knock-outs for bungee cords (not included) secures your cargo

» 2882080

XP 4 1000/TURBO '14-19, XP 1000/TURBO '14-19, S4 1000 EPS '19, S 900 EPS '19, S 900 '19, S 1000 EPS '19, S 1000 '16-19, 900 S '15-18, 900 EPS '19, 900 '14-19, 4 900 '15-18, 1000 S '17-18



OVERHEAD BAG

» 2879516

XP 4 1000/TURBO '14-19, XP 1000/TURBO '14-19, S4 1000 EPS '19, S 900 EPS
'19, S 900 '19, S 1000 EPS '19, S 1000 '16-19, 900 S '15-18, 900 EPS '19, 900
'14-19, 4 900 '15-18, 1000 S '17-18



UPPER DOOR STORAGE BAG

» 2880612

XP TURBO S '18, XP 4 1000/TURBO '14-19, XP 1000/TURBO '14-19, S4 1000
EPS '19, S 900 EPS '19, S 900 '19, S 1000 EPS '19, S 1000 '16-19, 900 S '15-18,
4 900 '15-18, 1000 S '17-18



LOWER DOOR STORAGE BAG

» 152.4 cm • 2880613

XP TURBO S '18, XP 4 1000/TURBO '14-19, XP 1000/TURBO '14-19, S4 1000
EPS '19, S 900 EPS '19, S 900 '19, S 1000 EPS '19, S 1000 '16-19, 900 S '15-18,
4 900 '15-18, 1000 S '17-18

REQUIRES LOWER DOOR 2879509

» 127 cm • 2880616

900 EPS '19, 900 '14-19

REQUIRES LOWER DOOR 2880207



SPARE TIRE HOLDER

» 2880148

S4 1000 EPS '19, S 900 EPS '19, S 900 '19, S 1000 EPS '19, S 1000 '16-19, 900 S '15-18, 900 EPS '19, 900 '14-19, 4 900 '15-18, 1000 S '17-18



REAR TIRE HOLDER

» 2879464

XP 4 1000/TURBO '14-19, XP 1000/TURBO '14-19

RZR XP TURBO S

LIGHTING

RIDE COMMAND & AUDIO

WHEELS & TIRES

CAGES & ROOFS

BUMPERS & PROTECTION

DOORS & WINDOWS/REAR PANELS

STORAGE & COCKPIT ACCESSORIES

COOLERS, WINCHES, PLOWES & MISC.

KOLPIN[®] OUTDOORS

PROTECT THE GEAR YOU NEED. LIVE THE LIFE YOU LOVE.

RHINO GRIPS[®]



LOCK & RIDE

RHINO GRIP[®] PRO

» 2884119
ALL RZR MODELS



LOCK & RIDE

RHINO GRIP[®] XL

» 2881513
ALL RZR MODELS



RHINO GRIP[®] XL REPLACEMENT RUBBER STRAPS

» 2881621
ALL RZR MODELS



LOCK & RIDE

RATCHETING RHINO GRIP[®]

» 2881157
ALL RZR MODELS



LOCK & RIDE

RHINO GRIP[®] XL DOUBLE

» 2884120
ALL RZR MODELS



RHINO GRIP[®] PRO REPLACEMENT RUBBER STRAPS

» 2884109
ALL RZR MODELS

We would like to thank our partners Browning[®] and Mathews[®] for helping to deliver a successful and safe off-road experience when out in the field.

Browning[®] is a registered trademark of Browning. Mathews[®] is a registered trademark of Mathews Archery Inc.



COCKPIT

ACCESSORIES



RZR SUBZERO 4 HARNESS

» DRIVER SIDE • 2882281

XP TURBO S '18, XP 1000/TURBO '14-19, S 900 EPS '19, S 900 '19, S 1000 EPS '19, S 1000 '16-19, 900 S '15-18, 900 EPS '19, 900 '14-19, 1000 S '17-18

» PASSENGER SIDE • 2882282

XP TURBO S '18, XP 1000/TURBO '14-19, S 900 EPS '19, S 900 '19, S 1000 EPS '19, S 1000 '16-19, 900 S '15-18, 900 EPS '19, 900 '14-19, 1000 S '17-18



CLICK-6 HARNESS

• Racing-quality premium construction for the greatest security and protection

• Six straps hold a driver securely in place in all riding conditions

• One-click, quick-release buckle releases straps, allows easy egress

» DRIVER SIDE • 2882244

XP TURBO S '18, XP 1000/TURBO '14-19, S 900 EPS '19, S 900 '19, S 1000 EPS '19, S 1000 '16-19, 900 S '15-18, 900 EPS '19, 900 '14-19, 1000 S '17-18

» PASSENGER SIDE • 2882245

XP TURBO S '18, XP 1000/TURBO '14-19, S 900 EPS '19, S 900 '19, S 1000 EPS '19, S 1000 '16-19, 900 S '15-18, 900 EPS '19, 900 '14-19, 1000 S '17-18

ALL WEATHER FLOOR MATS

» FRONT • 2880414

XP TURBO S '18, XP 1000/TURBO '14-19, S 900 EPS '19, S 900 '19, S 1000 EPS '19, S 1000 '16-19, 900 S '15-18, 900 EPS '19, 900 '14-19, 1000 S '17-18

» FRONT & BACK • 2880415

XP TURBO S '18, XP 4 1000/TURBO '14-19, XP 1000/TURBO '17-18, S4 1000 EPS '19, 4 900 '15-18



SEAT ADJUSTER KIT

» 2877390

570 EPS '19, 570 '12-19



HORN KIT

» 2880416

XP TURBO S '18, XP 4 1000/TURBO '14-19, XP 1000/TURBO '14-19, S4 1000 EPS '19, S 900 EPS '19, S 900 '19, S 1000 EPS '19, S 1000 '16-19, 900 S '15-18, 900 EPS '19, 900 '14-19, 4 900 '15-18, 1000 S '17-18

» 2877788

570 EPS '19, 570 '12-19

SEAT SLIDER

» 2879460

XP TURBO S '18, XP 4 1000/TURBO '14-19, XP 1000/TURBO '14-19, S4 1000 EPS '19, S 900 EPS '19, S 900 '19, S 1000 EPS '19, S 1000 '16-19, 900 S '15-18, 900 EPS '19, 900 '14-19, 4 900 '15-18, 1000 S '17-18



HEATER KIT

» 2881552

XP 4 1000/TURBO '14-19, XP 1000/TURBO '14-19, S4 1000 EPS '19, S 900 EPS '19, S 900 '19, S 1000 EPS '19, S 1000 '16-19, 900 S '15-18, 900 EPS '19, 900 '14-19, 4 900 '15-18, 1000 S '17-18

SWITCH PANEL

» 2881987

XP TURBO S '18, XP 4 1000/TURBO '14-19, XP 1000/TURBO '14-19, S4 1000 EPS '19, S 900 EPS '19, S 900 '19, S 1000 EPS '19, S 1000 '16-19, 900 S '15-18, 900 EPS '19, 900 '14-19, 4 900 '15-18, 1000 S '17-18



COMLINK RTX INTERCOM RADIO*

- Two person intercom with built-in two-way radio
- One compact easy use unit
- Radio range up to 5 miles

- No FCC license required to communicate with other VHF radios
- Intercom expandable: up to 8 positions

- Easily connect your phone or MP3 player to receive calls or listen to music



» 2881319

XP TURBO S '18, XP 4 1000/TURBO '14-19, XP 1000/TURBO '14-19, S4 1000 EPS '19, S 900 EPS '19, S 900 '19, S 1000 EPS '19, S 1000 '16-19, 900 S '15-18, 900 EPS '19, 900 '14-19, 4 900 '15-18, 1000 S '17-18

*The FM Frequency range is from 88 to 108 and only on the odds (i.e. 88.1, 88.3, etc.).

COMLINK IN-HELMET HEADSET

- Ride and talk with your helmet on
- Headset mounts inside your helmet and works with the Comlink RTX Radio

» 2881550

XP TURBO S '18, XP 4 1000/TURBO '14-19, XP 1000/TURBO '14-19, S4 1000 EPS '19, S 900 EPS '19, S 900 '19, S 1000 EPS '19, S 1000 '16-19, 900 S '15-18, 900 EPS '19, 900 '14-19, 4 900 '15-18, 1000 S '17-18

COMLINK RTX MOUNTING KIT

- Seamlessly integrate your Comlink RTX into your RZR
- Easily mounts inside Din Box area

» 2881320

XP TURBO S '18, XP 4 1000/TURBO '14-19, XP 1000/TURBO '14-19, S4 1000 EPS '19, S 900 EPS '19, S 900 '19, S 1000 EPS '19, S 1000 '16-19, 900 S '15-18, 900 EPS '19, 900 '14-19, 4 900 '15-18, 1000 S '17-18

4-PASS INTERCOM UPGRADE KIT

- Add your rear seat passengers to the conversation

» 2882016

XP TURBO S '18, XP 4 1000/TURBO '14-19, XP 1000/TURBO '17-18, S4 1000 EPS '19, 4 900 '15-18

MIRRORS ALWAYS HAVE YOUR BACK **6**



FOLDING SIDE MIRRORS **TOP SELLER**

- Includes left and right mirrors with mounting brackets and hardware
- Hinges feature breakaway design for tight trail conditions and easy trailering
- Mounts directly to factory roll cage at the bolt location, works with windshields and doors

» 2881198

XP TURBO S '18, XP 4 1000/TURBO '14-19, XP 1000/TURBO '14-19, S4 1000 EPS '19, S 900 EPS '19, S 900 '19, S 1000 EPS '19, S 1000 '16-19, 900 S '15-18, 900 EPS '19, 900 '14-19, 4 900 '15-18, 1000 S '17-18

CONVEX REARVIEW MIRROR **TOP SELLER**

- Installs easily: mount bolts into your choice of pre-designated mounting locations on vehicle frame
- Convex design provides broad, expanded view of what's behind or alongside the vehicle



» 2881540

XP TURBO S '18, XP 4 1000/TURBO '14-19, XP 1000/TURBO '14-19, S4 1000 EPS '19, S 900 EPS '19, S 900 '19, S 1000 EPS '19, S 1000 '16-19, 900 S '15-18, 900 EPS '19, 900 '14-19, 570 '12-19, 4 900 '15-18, 1000 S '17-18

SCRATCH-RESISTANT GLASS MIRROR LENS

REAR VIEW MIRROR

- Works with all roofs, soft tops and windshields

» 2877945

XP TURBO S '18, XP 4 1000/TURBO '14-19, XP 1000/TURBO '14-19, S4 1000 EPS '19, S 900 EPS '19, S 900 '19, S 1000 EPS '19, S 1000 '16-19, 900 S '15-18, 900 EPS '19, 900 '14-19, 570 EPS '19, 570 '12-19, 4 900 '15-18, 1000 S '17-18



CONVEX DESIGN DELIVERS WIDE REAR VIEW

WIDE-ANGLE REARVIEW MIRROR

- Stamped steel frame and backing plate with large 6.4 cm x 35.6 cm convex mirror
- Up to 10° of adjustability to adjust to rider height or view preference
- Easy over-structure installation with stamped steel mounts

» 2881199

XP TURBO S '18, XP 4 1000/TURBO '14-19, XP 1000/TURBO '14-19, S4 1000 EPS '19, S 900 EPS '19, S 900 '19, S 1000 EPS '19, S 1000 '16-19, 900 S '15-18, 900 EPS '19, 900 '14-19, 570 '12-18, 4 900 '15-18, 1000 S '17-18



QUICK GLANCE, WIDE-ANGLE VIEWING FOR MAXIMUM VISIBILITY

KEEP IT ICE COLD



POLARIS NORTHSTAR COOLERS can survive just about anything - from extreme heat to a nasty tumble off a vehicle. So when we say ice will stay cold for hours on end and anything inside will stay locked up tight, we mean it.

POLARIS NORTHSTAR COOLER



99 LITER

- » GRAPHITE • 2883426
- » DESERT • 2883392



57 LITER

- » GRAPHITE • 2883425
- » DESERT • 2881259



28 LITER

- » GRAPHITE • 2883424
- » DESERT • 2881315



14 LITER **NEW**

- » GRAPHITE • 2883968



19 LITER SOFTSIDE

- » GRAPHITE • 2883390

28, 57 & 99 LITER FEATURES



ComfortCarry Handles



TravelLock System



EasyOut Drain System



NoSlip Rubber Feet



PolarWall Insulation



IceLock Seal



TUMBLERS

- » 887 mL • 2883394
- » 591 mL • 2883393

GRIZZLY TESTED. POLARIS APPROVED.



This cooler is IGBC-approved, meaning it withstands the power expended by a typical grizzly bear if it was trying to get inside. Seriously, there are experts who know what a grizzly is capable of doing, and they certify that the Polaris Northstar Cooler can take it.



POLARIS NORTHSTAR COOLER ACCESSORIES



WIRE BASKET

- » 99 LITER • 2883648 **NEW**
- » 57 LITER • 2882185
- » 28 LITER • 2882438



DIVIDERS

- » 99 LITER • 2883468 **NEW**
COMES WITH ONE DIVIDER
- » 57 LITER • 2882184
COMES WITH TWO DIVIDERS
- » 28 LITER • 2882186
COMES WITH ONE DIVIDER

Divider doubles as a cutting board



SEAT CUSHION

- » 57 LITER • 2882179
- » 28 LITER • 2882507

COOLER WHEELS

- » 57 LITER • 2882180

BOTTLE OPENER

- » 2882183
ALL COOLERS



NEW 3.8 cm x 4.6 m 2495 kg RATCHET STRAP

- 3.8 cm x 4.6 m straps, 2 Pack
- Heavy duty webbing
- 2495 kg maximum load, 831 kg working load
- » 2884031



NEW 5.1 cm x 6.1 m 4536 kg RATCHET STRAP

- 5 cm x 6.1 m Ratchet Straps
- Heavy duty webbing, floating D-rings, double J-hooks
- 4536 kg maximum load, 1497 kg working load
- » 2884032

ACCESSORIES

RZR XP TURBO S

LIGHTING

RISE COMMAND
& AUDIO

WHEELS & TIRES

CAGES & ROOFS

BUMPERS &
PROTECTION

DOORS & WINDSHIELD/
REAR PANELS

STORAGE & COCKPIT
ACCESSORIES

COOLERS, WINDCHES,
PLOWES & MISC

CHOOSE THE RIGHT WINCH

PRO

PRO HEAVY DUTY SERIES

PREMIUM FEATURES FOR TOP-OF-THE-LINE POWER



INDUSTRY 1ST NEW TECHNOLOGY

RAPID ROPE RECOVERY 5X FASTER

RAPID ROPE RECOVERY

1. Set Winch Dial to FREE SPOOL (N) to attach Winch Hook
2. Set Winch Dial to PULL (L) for Winch Mode
3. Set Winch Dial to ROPE RECOVERY (H) for 5x Faster Rope Recovery



PREASSEMBLED

Winch ready to install out of the box. Attached to mount and pre-wired.



WIRELESS REMOTE

15 m range wireless remote control with unique code for interference-free operation



PREMIUM SYNTHETIC ROPE

- Lightweight & Easy to Handle
- Superior Flexibility
- Greater Strength than Steel Cable
- 15 m long

AUTO STOP TECHNOLOGY

Auto Stop Technology stops winch at end of pull to prevent driveline stress and plow overlifting

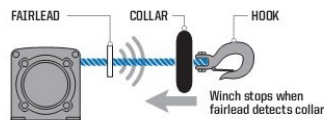

3 STEPS FOR ADDING A WINCH:

1 FIND YOUR MACHINE

2 CHOOSE BETWEEN POLARIS PRO HD

	PRO PRO HEAVY DUTY SERIES
	2041 kg
	NEW TOP SELLER WINCH COVER KIT NEW 2882240 2884118 <small>REQUIRED WITH INSTALL OF 2882240, 2881671 ON XP 1000/TURBO '19 MODELS</small>
XP TURBO S '18	NEW 2883828
RZR RS1 '18-19	NEW 2883825





I-HD HEAVY DUTY SERIES **PULLING POWER FOR EVERYDAY USE & PERFORMANCE**

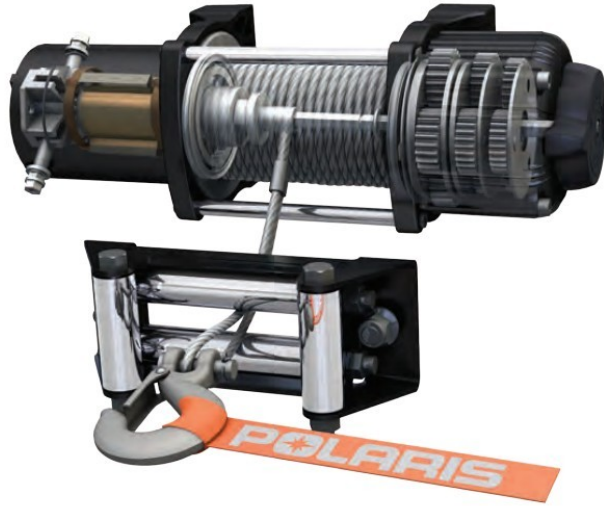

- Cut steel gears for improved durability
- Steel spool can handle extreme loads
- 40% quieter – near-silent free spooling
- Sealed motor and drivetrain
- High-powered contactor
- Integrated wiring and mount plates ensure perfect fit

OR POLARIS HD WINCH

3 ADD CABLES

I-HD HEAVY DUTY SERIES

1588 kg

REQUIRED BATTERY CONNECTION CABLES

TOP SELLER
2881671

WINCH COVER KIT *NEW*

» 2884118

REQUIRED WITH INSTALL OF 2882240, 2881671 ON XP 1000/TURBO '19 MODELS

XP 1000 & 900 '14-15: 2879862
XP 1000 & 900 '16-17: 2881551
XP 4 1000 & 900 '14-15: 2880055
XP 4 1000 & 900 '16-17: 2881646
ALL OTHER MODELS/YEARS,
INCLUDED WITH WINCH

INCLUDED WITH WINCH

INCLUDED WITH WINCH

UPGRADE YOUR POLARIS HD WINCH WITH THESE ACCESSORIES

POLARIS WIRELESS WINCH REMOTE

- Allows for remote operation of Polaris HD winch
- 100 ft (30 m) range
- Operating 12V system
- 2879411
- \$129.99



AUTO STOP TECHNOLOGY WINCH UPGRADE

- Prevents overheating, improves the winch's operating performance and lifespan
- Operates only in gear or 4:1:1 forward
- Requires a 4-pin connector and the correct cable harness (2879240)
- 2879240
- \$149.99



SYNTHETIC WINCH ROPE

- 2879241
- \$149.99
- 2879242
- \$149.99

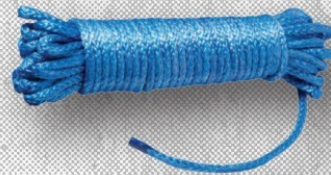

1588 kg WINCH REPLACEMENT STEEL CABLE

- 2879243
- \$149.99



ACCESSORIES

RZR XP TURBO S

LIGHTING

RIDE COMMAND & AUDIO

WHEELS & TIRES

CAGES & ROOFS

BUMPERS & PROTECTION

DOORS & WINDOWSHIELD/ REAR PANELS

STORAGE & COCKPIT ACCESSORIES

COOLERS, WINCHES, PUMPS & MISC.

GLACIER^{HD} PLOW SYSTEM



GLACIER^{HD} GIVES YOU

» 168 cm
Blades

» Choice of
poly or steel

» Manual angle
system standard



168 cm POLY BLADE
BEST FOR CORROSION RESISTANCE

168 cm STEEL BLADE
BEST FOR BIG JOBS YEAR AFTER YEAR

LOCK & RIDE

MAKE QUICK WORK OF SMALLER JOBS

Move snow with the robust and capable Glacier^{HD} plow system, and discover why a major snowfall can be the highlight of your week. With a robust frame, beefy poly and steel blade options, dismantling and amazing value, Glacier^{HD} is a great choice in the dead of winter.

CREATE YOUR GLACIER^{HD}
PLOW SYSTEM IN 5 STEPS

	STEP 1 SELECT A MOUNT	STEP 2 SELECT A FRAME	STEP 3 SELECT A LIFT METHOD	STEP 4 SELECT A BLADE	STEP 5 SELECT ACCESSORIES
MODELS	MOUNT	FRAME	WINCH	BLADES	ACCESSORIES
S4 1000 EPS '19, S 900 EPS '19, S 900 '19, S 1000 EPS '19, S 1000 '16-19, 900 S '15-18, 900 EPS '19, 900 '14-19, 4 900 '15-18, 1000 S '17-18	GLACIER^{Pro} Plow Mount 2880262	GLACIER^{Pro} HD Plow Frame 2880260	Polaris PRO HD 2041 kg Winch See previous page Polaris HD 1588 kg Winch See previous page	GLACIER^{Pro} Plow 168 cm Poly 2880269 GLACIER^{Pro} Plow 168 cm Steel 2880268	168 cm Snow Deflector 2879866 168 cm HD Wear Bar 2879868 168 cm Wear Bar 2879867 Plow Marker 2872726 Skid Shoe 2205071 Shear Pin 2205527 Extension for Tracks 2880267

RZR NEON SIGN

» 2882478



TURBO HOOD

» 2881467

XP 4 1000/TURBO '14-19, XP 1000/TURBO '14-19, S4 1000 EPS '19, S 900 EPS '19, S 900 '19, S 1000 EPS '19, S 1000 '16-19, 900 S '15-18, 900 EPS '19, 900 '14-19, 4 900 '15-18, 1000 S '17-18



RZR WHIP FLAG

» 2881468

XP TURBO S '18, XP 4 1000/TURBO '14-19, XP 1000/TURBO '14-19, S4 1000 EPS '19, S 900 EPS '19, S 900 '19, S 1000 EPS '19, S 1000 '16-19, 900 S '15-18, 900 EPS '19, 900 '14-19, 570 '12-18, 4 900 '15-18, 1000 S '17-18

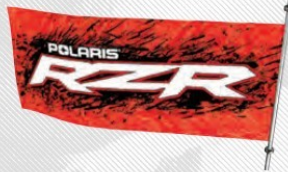

FLAG MOUNT

» 2877502

XP TURBO S '18, XP 4 1000/TURBO '14-19, XP 1000/TURBO '14-19, S4 1000 EPS '19, S 900 EPS '19, S 900 '19, S 1000 EPS '19, S 1000 '16-19, 900 S '15-18, 900 EPS '19, 900 '14-19, 570 EPS '19, 570 '12-19, 4 900 '15-18, 1000 S '17-18



RIDE & REPAIR ESSENTIALS KIT

» 2881207



OFF-ROAD JACK KIT

» 2881201

XP TURBO S '18, XP 4 1000/TURBO '14-19, XP 1000/TURBO '14-19, S4 1000 EPS '19, S 900 EPS '19, S 900 '19, S 1000 EPS '19, S 1000 '16-19, 900 S '15-18, 900 EPS '19, 900 '14-19, 570 '12-18, 4 900 '15-18, 1000 S '17-18



FIRE EXTINGUISHER MOUNT

» 2881200

XP TURBO S '18, XP 4 1000/TURBO '14-19, XP 1000/TURBO '14-19, S4 1000 EPS '19, S 900 EPS '19, S 900 '19, S 1000 EPS '19, S 1000 '16-19, 900 S '15-18, 900 EPS '19, 900 '14-19, 570 '12-18, 4 900 '15-18, 1000 S '17-18

Prospector[®] PRO TRACK SYSTEM

OPTIMIZED WEIGHT DISTRIBUTION

- Triangular geometry ensures optimized load distribution for best flotation
- Vehicle weight is spread over larger area, to reduce down pressure and prevent sinking
- 227 kg maximum cargo load with tracks installed

DURABILITY AND RELIABILITY

- Triple sealed main bearings and oil bath bearing housing offer superior load ratings and resist contamination for longer life expectancy
- Extra wide rubber-coated mid rollers with double-sealed bearings resist ice build-up, and spread the load of vehicle to increase flotation and maintain load rating on tracks

OUTSTANDING TRACTION

- Rubber tracks are engineered to create optimized traction across the greatest track surface area
- The track rubber compound and design resist deflection to maintain a stable contact patch on the ground to deliver great performance and comfort

EASY STEERING, SURE HANDLING

- Polaris side-by-side track system steering is optimized by a rigid track frame, specifically designed Polaris hubs, and track design
- Easiest steering, sure handling and reduced vibration



NON EPS MODEL

- › 2880757
20 FRONT 18 REAR
FOR USE ON THE FOLLOWING MODELS NOT EQUIPPED WITH FACTORY EPS: \$ 900 '19, \$ 1000 '19, 900 S '15-18, 900 '15-19, 1000 S '18

- › MOUNTS • 2880648
900 '15-19, 900 EPS '15-19, 900 XC '15-18
MOUNTS FIT 50" WIDE RZR MODELS

EPS MODEL

- › 2880758
18 FRONT 18 REAR
FOR USE ON THE FOLLOWING MODELS THAT COME WITH FACTORY-INSTALLED EPS: 900 EPS '15-19, 900XC '15-18, \$ 900 EPS '15-19, \$ 1000 EPS '15-19

- › MOUNTS • 2880649
FITS THE FOLLOWING 60" WIDE RZR MODELS: \$ 900 '15-19, \$ 900 EPS '15-19, \$1000 EPS '16-19, 4 900 '15-19

FLOW EXTENSION 2880267 REQUIRED FOR USING A FLOW WITH TRACKS
ONLY COMPATIBLE WITH GLACIER PRO HD SYSTEM

570

LOCK & RIDE SPORT ROOF

- › BLACK • 2878748
570 EPS '19, 570 '12-19

LOCK & RIDE POLY WINDSHIELD

- › 2879492
570 '12-18

HALF DOORS WITH TOP NETS

- › BLACK • 2879614
570 EPS '19, 570 '12-19

REAR DELUXE BRUSHGUARD

- › 2878697
570 EPS '19, 570 '12-19

HALF WINDSHIELD

- › 2879493
570 '12-18

FRONT DELUXE BRUSHGUARD

- › 2878284
570 EPS '19, 570 '12-19

POLARIS HD 3500 LB WINCH

- › 2879334
570 EPS '19, 570 '12-19



170

HALF WINDSHIELD

- Provides protection from rain, debris and branches
- Retains open-air riding environment
- Adds sporty style
- Installs easily and securely

- › 2877684
170 '14, '16-19



FRONT BRUSHGUARD

- Strong, tough, and protective
- Protects front end of vehicle from impact
- Styling and finish complement vehicle's look
- Easy bolt-on installation

- › 2877813
170 '14, '16-19



SOFT TOP

- Adds sporty styling and offers protection
- Protects against rain, overhead branches, etc.
- Provides shade for riders
- Easy installation

- › 2877685
170 '14, '16-19



ACCESSORIES

RZR XP TURBO S
& RZR RS1

LIGHTING

RIDE COMMAND
& AUDIO

WHEELS & TIRES

CAGES & ROOFS

BUMPERS &
PROTECTION

DOORS & WINDSHIELD/
REAR PANELS

STORAGE & COCKPIT
ACCESSORIES

COOLERS, WINCHES,
FLOWS & MISC.



SPECIFIC NEEDS, **SPECIFIC OILS**

Polaris invests millions in engine development, and part of that investment is making sure its lubricants—critical to engine performance—are the right formula for your specific engine. The amount of testing data and engineering resources used in developing Polaris lubricants would overwhelm an aftermarket company. Therefore, the aftermarket must spec an oil to an industry-wide standard that must account for a variety of operating parameters.

PS-4 is designed specifically for Polaris 4-cycle engines and has high film strength and wear protection under extreme loads and temperatures. Exclusive anti-wear additives protect engine parts with extra rust and corrosion protection.

PS-4 FULL-SYNTHETIC OIL

• PS-4 is optimal for ambient operating temperatures of -40° C to 38° C

- » 1L • 2877263
- » 4L • 2877264
- » 25 L • 2877868
- » 60 L • 502338
- » 200 L • 2878003

PS-4 OIL CHANGE KIT

• Contains the correct amount of oil for your vehicle and correct oil filter

- » 2202166
SINGLE 570, TWIN 600, TWIN 700, TWIN 800
- » 2879323
RANGER/RZR900/1000
- » 2880913
POLARIS ACE/ETX 325
- » 2877473
330500, SPORTSMAN 550/850/1000

PS-4 EXTREME-DUTY FULL-SYNTHETIC OIL

• PS-4 Extreme Duty is optimal for ambient operating temperatures of -18° C to 53° C

- » 1L • 2879037
- » 4L • 2879251
- » 25 L • 2879252
- » 60 L • 2879003
- » 200 L • 2879038

POLARIS® PS-4 VS THE COMPETITION

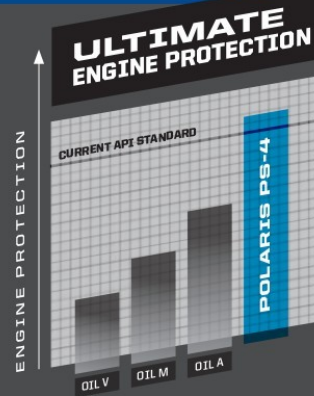

Polaris PS-4 oils exceed the latest industry protection standard as set by the API, while the competition uses standards from years ago. Our proprietary additives clean and protect critical engine parts under high operating temperatures.

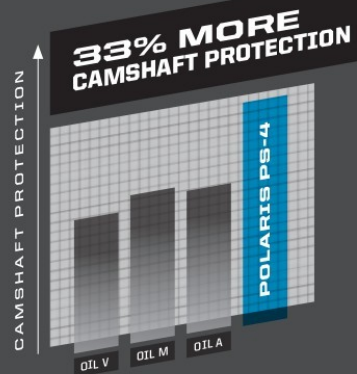

When tested against competitive oils, camshaft bearing races and lobes exhibit less wear when protected by Polaris PS-4 oil.

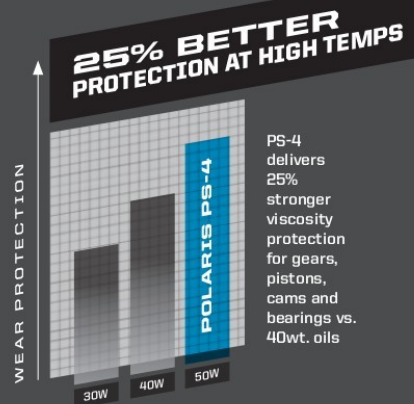

PS-4 delivers 25% stronger viscosity protection for gears, pistons, cams and bearings vs. 40wt. oils

WHY VISCOSITY MATTERS: Polaris engines are designed to operate using oils rated at a specific viscosity. Viscosity is the measure of an oil's resistance to flow and shear and a way to gauge an oil's "film strength", which is a critical component in preserving engine life when an oil is subject to high heat or heavy loads.

ENGINEERED TO MAXIMIZE THE LIFE OF YOUR RIDE

All Polaris fluids—from anti-freeze to brake fluid—are developed for your vehicle. Trust the only fluids perfectly engineered for your needs.



DOT 4 BRAKE FLUID



Polaris DOT 4 Brake Fluid is a high-quality brake fluid designed for use in Polaris hydraulic brakes. Superior high-temp characteristics plus anti-corrosive additives extend the life of brake system components and provide consistent, positive braking.

» 250 mL • 502081

ANTI-FREEZE



Polaris Extended Life Coolant contains organic acid technologies to prevent corrosion on metal components, eliminate scaling, and maximize cooling system performance.

» 1 L • 502103
» 25 L • 502271
» 206 L • 502091

AGL



A proprietary blend of additives designed to optimize Polaris® ORV transmission life. Extreme pressure additives protect gears, drive chain, and bearings from scoring and wear. Unlike typical gear case oils, AGL's unique viscosity range allows instant flow and film protection in extreme cold or high heat environments.

» 1 L • 502080
» 200 L • 502151
» 25 L • 502152

DEMAND DRIVE FLUID



Engineered specifically for Polaris ORV front drive systems. Provides positive 4WD engagement in extreme cold or high heat conditions. Unique friction additives protect internal components under heavy loads and promote positive engagement.

» 1 L • 502094
» 200 L • 502264
» 25 L • 502267

Proper lubricant application and timing will ensure optimal vehicle performance. Please refer to your owner's manual for lubricant change interval schedules.

CARBON CLEAN



Polaris Carbon Clean prevents ethanol corrosion, stabilizes fuel, and cleans fuel injectors, piston ring lands, intake systems, and combustion chambers. Helps maintain peak HP and improves fuel economy.

» 125 mL • 502082

FUEL STABILIZER



Fuel Stabilizer prevents ethanol corrosion and stabilizes fuel for up to 2 years. Dual-antioxidant formula protects against gum and varnish for easy starting.

» 125 mL • 502100

ANGLE DRIVE FLUID



» 1 L • 502089
» 25 L • 502268
» 202 L • 502266
SPORTSMAN,
RANGER, RZR
ANGLE DRIVE GEAR
CASE SYSTEMS

PREMIUM GAS SHOCK OIL

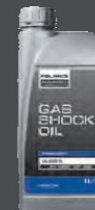

» 1 L • 502098

ALL-SEASON GREASE TUBE



» 400 g • 502068

FOR THE LIFE OF YOUR RIDE

AIR FILTERS

Critical to engine performance and reliability. A clogged air filter can restrict air flow to the engine leading to reduced engine performance. Dirt and debris ingestion can damage the engine leading to reduced engine life or catastrophic failure. Polaris recommends changing the vehicle's air filter at the specified intervals outlined in the owner's manual, which may be shorter if your vehicle is subject to severe conditions.

BRAKE PADS

Check your brakes if you are close to the recommended service interval, hear grinding when applying the brakes, your vehicle is taking longer to stop or if you have to apply more pressure to your pedal to engage the brakes. Check the brake discs for signs of cracks, excessive corrosion or warping.

If the brake pads are contaminated with oils or grease (petroleum products), brake pads have to be discarded and replaced.

Discs need to be cleaned with brake cleaner or alcohol based cleaner only.



MAINTENANCE SCHEDULE

25 HRS/400 km

BREAK-IN MAINTENANCE

ENGINE OIL:
CHANGE

GENERAL LUBRICATION:
ALL FITTINGS, PIVOTS, CABLES, ETC.

AIR FILTER:
INSPECT & CLEAN
REPLACE AS NEEDED

EXHAUST SYSTEM:
INSPECT & CLEAN
INSPECT FOR LEAKAGE OR CARBON BUILD UP AT JOINTS
INSPECT & CLEAN SCREEN TYPE SPARK ARRESTOR

50 HRS/800 km

6 MONTHS

EXHAUST SYSTEM:
INSPECT & CLEAN
INSPECT FOR LEAKAGE OR CARBON BUILD UP AT JOINTS
INSPECT & CLEAN SCREEN TYPE SPARK ARRESTOR

GENERAL LUBRICATION:
ALL FITTINGS, PIVOTS, CABLES, ETC.

DRIVE BELT:
INSPECT & ADJUST
REPLACE AS NEEDED

100 HRS/1600 km

12 MONTHS

ENGINE OIL:
CHANGE

DRIVE BELT:
INSPECT & ADJUST
REPLACE AS NEEDED

TRANSMISSION FLUID:
CHANGE

EXHAUST SYSTEM:
INSPECT & CLEAN
INSPECT FOR LEAKAGE OR CARBON BUILD UP AT JOINTS
INSPECT & CLEAN SCREEN TYPE SPARK ARRESTOR

150 HRS/2400 km

18 MONTHS

ENGINE OIL:
CHANGE

BATTERY:
TEST, CLEAN, & CHECK FLUID LEVEL
REPLACE AS NEEDED

DRIVE BELT:
INSPECT & ADJUST
REPLACE AS NEEDED

TIRES:
INSPECT CONDITION & PRESSURE

EXHAUST SYSTEM:
INSPECT & CLEAN
INSPECT FOR LEAKAGE OR CARBON BUILD UP AT JOINTS
INSPECT & CLEAN SCREEN TYPE SPARK ARRESTOR

THE KEY TO KEEPING YOUR POLARIS OFF-ROAD VEHICLE PERFORMING

as well as the day you brought it home is proper maintenance. Items like belts, filters, and batteries represent only a few of these critical items engineered specifically by Polaris.



DRIVE BELTS

Polaris Engineered belts deliver unmatched performance for your off-road vehicle. Developed and tested on all our engines for all environments and conditions. Check your belt for delamination, hour glassing and glazing.

OIL FILTERS

Change oil filters with every oil change to provide the best protection for your engine. Superior engine protection keeps your engine operating at peak performance. Be sure to follow the suggested service intervals for oil/oil filter changes.

BATTERIES

Never leave a battery unattended during the storage season. To ensure your battery maintains its level of charge when unused for extended periods of time or during freezing weather, the battery should be connected to a BatteryMINDER®. Be sure to check for corrosion from the terminals to the ends of the cables.

MAINTENANCE TIP

BREAK-IN PERIOD

The break-in period for your new RZR is the first 25 hours of operation, or the time it takes to use the first two tanks of fuel. No single action on your part is as important as a proper break-in period. Careful treatment of a new engine will result in more efficient performance and longer life for the engine. Perform the listed procedures carefully.

NOTICE: Excessive heat build-up during the first three hours of operation will damage close-fitted engine parts. Do not operate at full throttle or high speeds for extended periods during the first three hours of use.

200 HRS/3200 km

24 MONTHS

ENGINE OIL:
CHANGE

**BRAKE PADS
& FLUID:**
INSPECT & CLEAN
REPLACE AS NEEDED

SPARK PLUGS:
INSPECT
REPLACE AS NEEDED

EXHAUST SYSTEM:
INSPECT & CLEAN
INSPECT FOR LEAKAGE OR
CARBON BUILD UP AT JOINTS
INSPECT & CLEAN SCREEN
TYPE SPARK ARRESTOR

350 HRS/4020 km

30 MONTHS

ENGINE OIL:
CHANGE

BATTERY:
TEST, CLEAN, &
CHECK FLUID LEVEL
REPLACE AS NEEDED

DRIVE BELT:
INSPECT & ADJUST
REPLACE AS NEEDED

**GENERAL
LUBRICATION:**
ALL FITTINGS, PIVOTS,
CABLES, ETC.

EXHAUST SYSTEM:
INSPECT & CLEAN
INSPECT FOR LEAKAGE OR
CARBON BUILD UP AT JOINTS
INSPECT & CLEAN SCREEN
TYPE SPARK ARRESTOR

500 HRS/8045 km

36 MONTHS

ENGINE OIL:
CHANGE

AIR FILTER:
INSPECT, CLEAN
REPLACE AS NEEDED

COOLANT:
CHECK LEVEL
REPLACE EVERY 2 YEARS

GEARCASES:
CHECK OIL LEVEL

EXHAUST SYSTEM:
INSPECT & CLEAN
INSPECT FOR LEAKAGE OR
CARBON BUILD UP AT JOINTS
INSPECT & CLEAN SCREEN
TYPE SPARK ARRESTOR

CHECK YOUR
OWNER'S MANUAL
FOR ADDITIONAL
RECOMMENDED
SERVICE ITEMS
AND VEHICLE-
SPECIFIC TIMING

SERVICE PARTS

Polaris Engineered service parts deliver unmatched performance and fit for your off-road vehicle.

All service parts are developed and tested for your vehicle. Half shafts, bushings, bearings, decals, side panels, electrical components, and clutching components are the same parts that are manufactured on the factory lines for each specific vehicle. This ensures it doesn't merely fit your vehicle - it outperforms your expectations!

**VISIT YOUR POLARIS DEALER
TO SHOP FOR SERVICE PARTS.**

OVER
100,000
PARTS
AVAILABLE!



FOR THE LIFE OF YOUR RIDE

Maintenance is the key to keeping your Polaris off-road vehicle performing at its peak. Items like belts, lubricants, and batteries represent only a few of these critical items engineered specifically by Polaris.



POLARIS ENGINEERED DRIVE BELTS

TESTED, PERFECTED

We test each belt on the intended vehicle - we don't just try to make an existing belt "just work".

- Amery Kuhl, Polaris® CVT System Engineer

OUR INVESTMENT

- 32,187 km of field testing
- Thousands of dyno hours
- 18+ months of development (3,000+ design hours) per belt
- 1200+ vehicle validation hours
- Collaboration with powertrain & clutch engineers

YOUR ADVANTAGE

- No clutch recalibration
- Less wear & tear due to heat
- Ensure maximum performance of your vehicle
- More time out riding, less time wrenching

**OUR INVESTMENTS ENSURE POLARIS BELTS
OUTPERFORM YOUR EXPECTATIONS.**



KEEP IT CLEAN

CLEAN ALL-PURPOSE CLEANER

- Professional cleaner, which is formulated with a low pH-value. The product spreads well on surfaces and adheres on them for effective cleaning action. Perfectly compatible with rubber, plastic and painted surfaces. The formulation is biodegradable.

» 500 mL • 502309

SHINE INSTANT SHINE & DETAILER

- The INSTANT SHINE AND DETAILER is developed for cleaning action without water. Removes insects, dust and dirt with almost no effort. Applicable for plastics, visors, windscreens, paint and metal. The wipe and shine formulation makes surfaces shine, works water repellent and also has an antistatic effect. Perfect for customers living in urban areas with no access to water, for bike trips or showroom bikes.

» 500 mL • 502303



BRING IT EVERYWHERE

TRAILERING



RAMP PRO BY CALIBER®

- Designed for ATVs and UTVs up to 127 cm wide
 - Integrated grip glides for ultimate traction
 - Folding sides for easy transportation and storing
- » 132 cm x 229 cm • 2883005



ALUMINUM ARCHED LOADING RAMPS

- » 193 cm x 30.5 cm • 907 kg • 2875384
- » 224 cm x 30.5 cm • 1361 kg • 2875386



LIGHTWEIGHT TRI-FOLD RAMPS

- Ramp folds up for transport
 - Capacity for up to 681 kg
 - Safety straps included
- » 183 cm x 130 cm • 2875385
» 208 cm x 130 cm • 2875860



FOLDING ALUMINUM ARCHED RAMPS

- Ramp folds up for transport
 - Capacity up to 1361 kg
 - Safety straps included
- » 224 cm x 30.5 cm • 2875387

HITCHES

3:1 HITCHES

VERSATILE 3 IN 1 FUNCTIONALITY

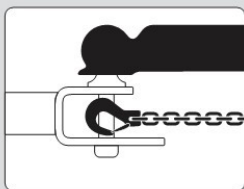

BALL

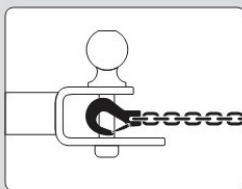

HOOK

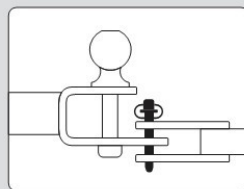

PIN

- Ball, pin and hook design
- Durable steel construction
- Rust resistant, black powdercoated finish
- Removable ball
- HD 5/8" pin and clip



NEW HITCH WITH 2" BALL

- » 2" x 2" RECEIVER
2830522
- » 1 1/4" x 1 1/4" RECEIVER
2830523



NEW 1 7/8" BALL

- 1 7/8" replacement ball for hitch
 - Designed to work with 3:1 Hitch
- » 2830524



RECEIVER HITCH

- » 2" RECEIVER TONGUE
2875320
- » FRONT HITCH RECEIVER
2878846



TRAILER BALL 3/4" SHANK

- » 1 1/8" BALL • 2877602
- » 2" BALL • 2877603

STRAPS & ROPES

NEW RECOVERY STRAP

- 5 cm x 9 m (8165 kg)
 - Comes with carry bag
- » 2884033



NEW RATCHET STRAP

- 3.8 cm x 4.6 m straps, 2 Pack
 - Heavy duty webbing
 - 2495 kg maximum load, 831 kg working load
- » 2884031



NEW RATCHET STRAP

- 5 cm x 6.1 m Ratchet Straps
 - Heavy duty webbing, floating D-rings, double J-hooks
 - 4536 kg maximum load, 1497 kg working load
- » 2884032



SHOCK STRAPS

- 3.8 cm 1361 kg breaking strength
- Keeps tension on tie-down straps to secure load
- 2 Pack
- » 3.8 cm x 4.6 m • 2883296
- » 3.8 cm x 2.1 m • 2883295

AIR FILTER

PREMIUM FILTER KIT

- Polaris Ultraweb high performance air filter
- Provides superior engine protection with 99.99% efficiency
- Superior dust-holding capacity
- Lower restriction offers better performance for high horsepower, torque, and acceleration

» 2882233

S4 1000 EPS '19, S 900 EPS '19, S 900 '19, S 1000 EPS '19, S 1000 '16-19, 900 S '15-18, 900 EPS '19, 900 '14-19, 4 900 '15-18, 1000 S '17-18

» 2882234

XP TURBO S '18, XP 4 1000/TURBO '14-19, XP 1000/TURBO '14-19

COVERS

TRAILERABLE COVER BY POLARIS

» 2-SEAT • 2880327

S 900 EPS '19, S 900 '19, S 1000 EPS '19, S 1000 '16-19, 900 S '15-18, 1000 S '17-18

» 2-SEAT • 2880325

900 EPS '19, 900 '14-19 SHOWN

» 2-SEAT • 2879373

XP 1000/TURBO '14-19



» 2-SEAT • 2876526

570 EPS '19, 570 '12-19

» 4-SEAT • 2879949

XP 4 1000/TURBO '14-19, S4 1000 EPS '19

» 2-SEAT • 2880326

S4 1000 EPS '19, 4 900 '15-18

**KINGPIN DIRT
509 GOGGLE**

- ECE Certified & DOT Approved
- Quick change lens and triple layer foam
- Anti-fog and anti scratch
- DNI SIZE
- 2868674 • LIME
- 2868668 • ORANGE

**ORV RIDING
JERSEY**

- S-3XL
- 2868711 • LIME
- 2867941 • PINK
- 2867942 • RED

 **COOL**

BE PREPARED FOR ANYTHING NATURE

COOLING SHIRTS

- 100% Poly, chemical-free patented fabric from CoolCore®
- Moisture wicking to keep you dry and cool
- UPF 45+
- S-3XL
- MEN'S
2868753 • GRAY
- WOMEN'S
2868755 • GRAY/PINK

POWERED BY
coolcore



 **COOL**

 **DRY**



FIND YOUR PERFECT HELMET!

RIDE SAFE - OUR HELMETS ARE DOT/ECE CERTIFIED



509° ALTITUDE CARBON HELMET

- Durable, ultra lightweight, Carbon Fiber
- Full carbon fiber shell
- 1100 grams

» S-4XL
2867814 • MATTE BLACK
2867815 • GLOSS BLACK



509° ALTITUDE HELMET

- Stylish, Lightweight with 509 Fit and Finish
- Thermoplastic poly alloy out shell
- 1260 grams

» S-4XL
2868539 • LIME 2867819 • RED
2867820 • BLUE 2867817 • GRAY
2867818 • ORANGE



TENACITY HELMET

- All the style and protection in our most affordable helmet
- Injection molded plastic
- 1450 grams

» XS-3XL
2868624 • PINK GLOSS 2868619 • BLACK MATTE
2868620 • BLACK/GRAY 2868623 • RED GLOSS
2868622 • BLUE GLOSS 2868621 • LIME GLOSS

SOFTSHELL JACKET

- Lined with 280 grams of fleece for warmth
- Removable hood
- Armpit zips for venting

WARM

» S-3XL
» MEN'S 2869919 • BLUE/ORANGE
2869918 • BLACK
» WOMEN'S 2869921 • CORAL
2869920 • BLACK

THROWS AT YOU



NEW RAIN SUIT

- Lightweight
- Waterproof
- Packs small
- Removable hood
- YKK® zippers

» JACKET • 2869527
S-3XL
» PANT • 2869528
S-3XL

PROTECT YOUR HANDS

OFF-ROAD RIDING GLOVES

- As seen in images at left

» S-3XL
2867937 • PINK 2867936 • RED
2867933 • GRAY 2867935 • ORANGE
2868712 • BLUE/LIME 2867934 • BLUE

MEN'S APPAREL



MEN'S RZR VAPOR HOODIE

- » S-3XL
- GRAY • 2869593
- RED HEATHER • 2869594



MEN'S AIR TEE

- » S-3XL
- BLACK • 2869591

MEN'S FULL ZIP HOODIE

- » S-3XL
- GRAY • 2868719

MEN'S 4-SCENE TEE

- » S-3XL
- NAVY • 2869599
- GRAY • 2868794



RZR LOGO HOODIE

» S-3XL
HEATHER NAVY • 2869586
CHARCOAL • 2869587



MEN'S EDGE TEE

» S-3XL
NAVY • 2869603
GRAY • 2868762



MEN'S CLASSIC TEE

» S-3XL
GRAY • 2869597
BLACK/RED • 2867886
RED • 2868764



MEN'S RZR LOGO TEE

» S-3XL
CHARCOAL • 2869584
NAVY • 2869585



WOMEN'S APPAREL

WOMEN'S TRAIL V-NECK TEE

- » S-3XL
TURQUOISE • 2869602
GRAY • 2868773
BLUE • 2868772



WOMEN'S 4-SCENE TEE

- » S-3XL
PURPLE FROST • 2869589
GRAY FROST • 2869588



WOMEN'S RZR VAPOR HOODIE

- » S-3XL
CHARCOAL HEATHER • 2869595
TEAL • 2869596



WOMEN'S RZR LOGO TEE

- » S-3XL
NAVY • 2869583
MARITIME • 2869582



WOMEN'S DUNE TEE

- » S-3XL
RASPBERRY • 2869588
NAVY • 2868775





WOMEN'S FULL ZIP RETRO HOODIE

- » S-3XL CHARCOAL • 2868595
- NAVY • 2868594



WOMEN'S BASEBALL 3/4 SLEEVE TEE

- » S-3XL GRAY/PINK • 2868584
- DARK GRAY • 2868585



WOMEN'S TECH FULL ZIP

- » S-3XL ASTER BLUE • 2869556

WOMEN'S SCRIPT TEE

- » S-3XL NAVY • 2868589



YOUTH APPAREL

YOUTH ORV RIDING JERSEY

- » S-XL PINK • 2867944
- RED • 2867943

YOUTH TENACITY HELMET

- CE Certified 6 DOT Approved
- » S-L PINK • 2868833
- RED • 2868831
- BLACK • 2868832



YOUTH VAPOR HOODIE

- » S-XL GRAY/PINK • 2867973

YOUTH AIR TEE

- » S-XL BLACK • 2869592





WOMEN'S ASYMMETRICAL HOODIE

- › S-3XL
BLACK • 2868597

WOMEN'S ROSEAU TEE

- › S-3XL
GRAY FROST • 2869559
BLACK • 2868586



MEN'S RETRO LOGO HOODIE

- › S-3XL
BLACK • 2869549
CHARCOAL/LIME • 2868578
GRAY/DRANGE • 2868577

MEN'S RETRO CAP

- › ONE SIZE
NAVY/LIME • 2869543

MEN'S ROSEAU HOODIE

- › S-3XL
CHARCOAL HEATHER • 2869553
NAVY HEATHER • 2868575
OLIVE HEATHER • 2868576



WOMEN'S CAMO HOODIE

- › S-3XL
CAMO/PINK • 2867898

MEN'S CAMO TECH FULL ZIP

- › S-3XL
CAMO • 2869590



CAMO WATER BOTTLE

- › 2867962

CAMO COFFEE TRAVEL MUG

- › 2867961

CAMO BOTTLE KOOZIE

- › 2867964

CAMO CAN KOOZIE

- › 2867963

CAMO STEERING WHEEL COVER

- › 2868663

CAMO BOTTLE OPENER [NOT SHOWN]

- › 2867965



MEN'S ESTA TEE

- › S-3XL
CHARCOAL HEATHER • 2869552
NAVY • 2869562
BLACK • 2868570

MEN'S FULL ZIP HOODIE

- › S-3XL
BLACK/RED • 2869530
NAVY • 2869532 [NOT SHOWN]

MEN'S RETRO CAP

- › ONE SIZE
CHARCOAL • 2869542





MEN'S LONG SLEEVE TECH 1/4 ZIP
 » S-3XL
 BLACK/RED • 2869535
 GRAY/LIME • 2869536



MEN'S TRAIL MID LAYER
 » S-3XL
 GRAY/BLACK • 2869925

MEN'S TECH MESH BEANIE
 » ONE SIZE
 BLACK • 2868650



MEN'S RETRO TRUCKER CAP
 » ONE SIZE
 RED • 2869540

MEN'S LONG SLEEVE RETRO TEE
 » S-3XL
 GRAY • 2868571

WOMEN'S BASEBALL 3/4 SLEEVE TEE
 » S-3XL
 WHITE/GRAY • 2869563



PINT GLASS SET OF 2
 » 2866265

RETRO CLOCK
 » 2868662



WOMEN'S HEX TEE
 » S-3XL
 GRAY FROST • 2869566
 NAVY FROST • 2869565

WOMEN'S RETRO CAP
 » ONE SIZE
 BLUE • 2869547

WOMEN'S SCRIPT CREW SWEATSHIRT
 » S-2XL
 AQUA • 2869557

WOMEN'S RETRO HOODIE
 » S-3XL
 NAVY • 2869555



MEN'S ROSEAU TEE
 » S-3XL
 CHARCOAL HEATHER • 2869560
 HEATHER BLUE • 2867778
 ASH HEATHER • 2869561

#RZR*Life*

LIVE THE LIFESTYLE

Unless noted, trademarks are the property of Polaris Industries Inc. 509® is a registered trademark of Teton Outfitters, LLC. Alodine® is a registered trademark of HENKEL AG & CO. KGA. BatteryMINDER® is a registered trademark of VDC Electronics Inc.. Bluetooth® is a registered trademark of Bluetooth Sig. Inc. Caliber® is a registered trademark of Caliber, Inc. COOLCORE® is a registered trademark of Tempnology LLC. DRE® is a registered trademark of Dreo, Inc. FOX® is a registered trademark of Fox Factory Inc. GoPro® is a registered trademark of GoPro Inc. Maxxis® is a registered trademark of Cheng Shin Rubber Ind. Co., Ltd.. MB Quart® is a registered trademark of Maxxsonics USA Inc. Rigid® is a trademark of JST Performance, LLC d/b/a Rigid Industries. Tiger Drylac® is a registered trademark of TIGER COATINGS GMBH & CO. KG. Walker Evans® is a registered trademark of Walker Evans Enterprises Corp.. Yeti® is a registered trademark of Yeti Coolers, LLC. YKK® is a registered trademark of YKK Corporation. Prices and availability are subject to change at any moment. © 2018 Polaris Industries Inc. All rights reserved.

Availability varies by market, check your local dealer for availability.



 POLARIS®
RZR®



KEEP IT COLD.



SEE P. 64



MY19 RZR APP ACC EMEA