

EMEA VERSION

POLARIS RZR

POPI

ACCESSORIES + APPAREL



RIDE OF YOUR LIFE



#RZR

LIVE THE LIFESTYLE.
JOIN THE COMMUNITY.



2021 LINEUP

WIDE OPEN

TURBO S P. 22



RZR TURBO S

XTREME PERFORMANCE

PRO XP P. 04



RZR PRO XP

XP 1000 P. 22



RZR XP 1000



RZR XP 4 1000

TRAIL

S 1000 & 570 P. 34



2020 RZR S 1000



RZR 570

YOUTH

P. 79

CONTENTS

PRO XP 04

AUDIO	08
WINDSHIELDS & REAR PANELS	10
ROOFS, DOORS & HEATER	12
VEHICLE PROTECTION & LIGHTING	14
STORAGE	16
MISC, MIRRORS & WINCHES	18

TURBO S 22

WINDSHIELDS & REAR PANELS	24
ROOFS & DOORS	26
VEHICLE PROTECTION & WINCHES	28
STORAGE & MIRRORS	30
RZR RS1	32

TRAIL 34

WINDSHIELDS & REAR PANELS	36
ROOFS & DOORS	38
BUMPERS & ROCK SLIDERS	40
STORAGE, WINCHES, PLOWS & TRACKS	42

COMMON ACCESSORIES 44

LIGHTING	44
RIDE COMMAND & AUDIO	50
PRO ARMOR WHEELS & TIRES	54
VEHICLE & RIDER PROTECTION	70
POLARIS NORTHSTAR COOLERS	72
COCKPIT & MIRRORS	74
WINCHES	76
ADDITIONAL ACCESSORIES & 570	78

YOUTH 79

PARTS & GARAGE 80

MAINTENANCE	80
OIL & LUBRICANTS	82
SERVICE PARTS	84
HD PARTS	86
VEHICLE CARE & TRAILERING	88

APPAREL & HELMETS 90

OUTERWEAR & PROTECTION	90
CASUALWEAR	96
CAMO & GIFTS	103

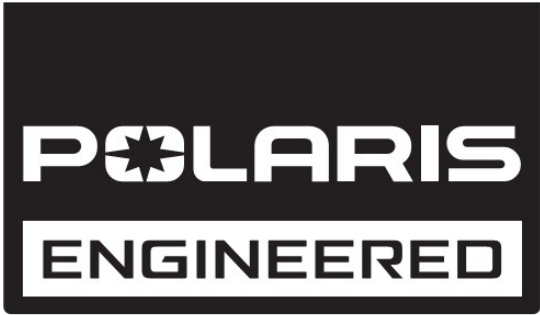

DESIGNED



Designed by the same people who designed your vehicle.

TESTED



Extensively tested in the field so you ride with 100% confidence.

WE HOLD OUR PARTNERS TO THE SAME STANDARDS

PRO ARMOR 
PREMIUM AFTERMARKET OPTIONS
DESIGNED WITH POLARIS TO
MAXIMIZE PERFORMANCE
P. 49, 54

 **Jockford Fosgate**
A GLOBAL LEADER IN
AUDIO INNOVATION,
DESIGN & ENGINEERING
P. 08

KEEP YOUR **STANDARDS**

HIGH. WE DO.

TRUSTED



65 years in the business.
The #1 name in Off-Road.

MBQUART

IGNITE AND FUEL YOUR
PASSION FOR PRECISE
QUALITY SOUND
REPRODUCTION
P. 52

RIGID

PRODUCTS SO GOOD
THEY REPLACE OR REPAIR
THEM FOR LIFE
P. 15, 48



MILITARY-GRADE AIR FILTRATION
THAT KEEPS YOUR AIR FILTER
CLEAN, & ENGINE PROTECTED.
P. 18

ASSAULT
INDUSTRIES

RACE PROVEN.
TRAIL READY.
P. 18

PRO XP

RZR PRO XP



**NEXT LEVEL OF
XTREME
PERFORMANCE**

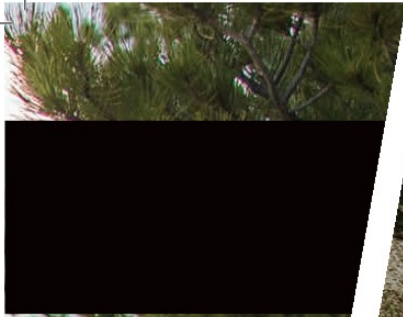

RIGID CHASE LIGHT
SEE P.15

PRO XP

> UNMATCHED ENGINEERING

Next-level innovations making your RZR unlike anything you've had before.

Rockford Fosgate Audio P. 08
Ride Command P. 08
Integrated Winch P. 19
RIGID Lighting P. 15

PLUG & PLAY ELECTRICAL



**EFFORTLESSLY ADD
LIGHTS, AUDIO & WINCH**

Polaris PULSE
Learn More P. 15

AUDIO

WINDSHIELDS
REAR PANELS

ROOFS, DOORS
& HEATER

VEHICLE PROTECTION
& LIGHTING

STORAGE

MISC. MIRRORS
& SWITCHES



> VISIONARY DESIGN

Relentless attention to detail delivering extraordinary style and function for the ultimate ride.

Windshields P. 11
Roofs P. 12
Doors P. 13
Mirrors P. 18



> ELEVATED FUNCTIONALITY

Unrivaled collection of accessories to give you even more reasons to get out - and stay out riding.

Protection P. 14
Storage P. 16
Wheels & Tires P. 54

PRO XP

RIDER ACCESSORY COLLECTIONS



Dominate the rocky landscape and charge through endless miles of desert.



2883743-458	ALUMINUM ROOF	P.12
2883749-458	HIGH COVERAGE BUMPER - FRONT	P.14
2884189-458	HIGH COVERAGE BUMPER - REAR	P.14
2889019	FULL VENTED WINDSHIELD - GLASS	P.11
2883962	GLASS WINDSHIELD WIPER KIT	P.11
2884666	MULTI-PASSENGER REAR SEAT CARGO BOX	P.17
2884907-458	PIVOTING SPARE TIRE CARRIER	P.17
2884623	23 QT. REAR COOLER	P.17
2883751	70L FORWARD CARGO BOX	P.16
2884359	RIGID CHASE LIGHT	P.15

Navigate the trails and soak up the old-growth groves, forests, plains and waterways.



2883928	ROOF - POLY	P.12
2883756	VENTED FULL WINDSHIELD- HARD COAT POLY	P.11
2883758	POLARIS PRO HD 4,500 LB WINCH	P.19
2883749-458	HIGH COVERAGE BUMPER- FRONT	P.14
2884189-458	HIGH COVERAGE BUMPER- REAR	P.14
2883997-458	KICK-OUT ROCK SLIDERS	P.14
2883765	DOOR CLOSEOFFS	P.13
2884907-458	PIVOTING SPARE TIRE CARRIER	P.17
2883751	70L FORWARD CARGO BOX	P.16
2883752	40L REAR CARGO BOX	P.16
2884304	7.25L DOOR STORAGE BAG	P.17



PRO XP

AUDIO

WINDSHIELDS
& REAR PANELS

ROOF, DOORS
& HEATER

VEHICLE PROTECTION
& LIGHTING

STORAGE

MISC. IMPROVS
& WINCHES

Safely climb pristine mountain trails for an epic view.



2883928	ROOF - POLY	P. 12
2883753	FULL WINDSHIELD - GLASS	P. 11
2883758	POLARIS PRO HD 4,500 LB WINCH	P. 19
2883749-458	HIGH COVERAGE BUMPER - FRONT	P. 14
2884189-458	HIGH COVERAGE BUMPER - REAR	P. 14
2883997-458	KICK-OUT ROCK SLIDERS	P. 14
2883752	40L REAR CARGO BOX	P. 16
2884304	7.25L DOOR STORAGE BAG	P. 17
2884907-458	PIVOTING SPARE TIRE CARRIER	P. 17

Take advantage of any season with year-round riding.



2883743-458	ALUMINUM ROOF	P. 12
2884662	TIP OUT WINDSHIELD - HARD COAT POLY	P. 11
2883757	REAR PANEL - HARD COAT POLY	P. 11
2884664	CANVAS UPPER HALF DOORS	P. 13
2884658	INNER DOOR CLOSEOFF PANEL	P. 13
2884386	HEATER KIT	P. 13
2883749-458	HIGH COVERAGE BUMPER - FRONT	P. 14
2884189-458	HIGH COVERAGE BUMPER - REAR	P. 14
2884685	FULL COVERAGE FENDER FLARES	P. 14
2883997-458	KICK-OUT ROCK SLIDERS	P. 14

PRO XP

INTRODUCING A NEW AUDIO EXPERIENCE



An industry first. A true factory installed integrated off-road audio system. Rockford Fosgate partnered with Polaris to build the loudest, highest performing system the industry has ever heard. Specifically tuned and rider-centric to create a class leading audio experience that is second to none.



PLUG AND PLAY



ELEMENT READY™



NO LOSS OF
CARGO SPACE



BLUETOOTH

SOURCE UNITS

- Rockford Fosgate engineered the first off-road tune, designed specifically for the Pro XP platform
- Tuned to combat wind and motor noise delivering an incredible sound no matter the speed
- IP certified design guards against dust and moisture intrusion

AMPLIFIERS

- Ultra Compact CLEAN technology
- Highly efficient design capable to be pushed hard without overheating

SPEAKERS

- Off-Road Optimized Element Ready™ speakers that thrive in any outdoor environment
- Specifically tuned enclosures create rich cockpit sound perfect for the Pro XP rider
- Rugged but lightweight materials without sacrificing speed for sound

SUBWOOFERS

- Rockford Fosgate designed, high-power, high-excursion subwoofer that acoustically couples with the cockpit for perfect bass response
- Torture tested to ensure long life and performance

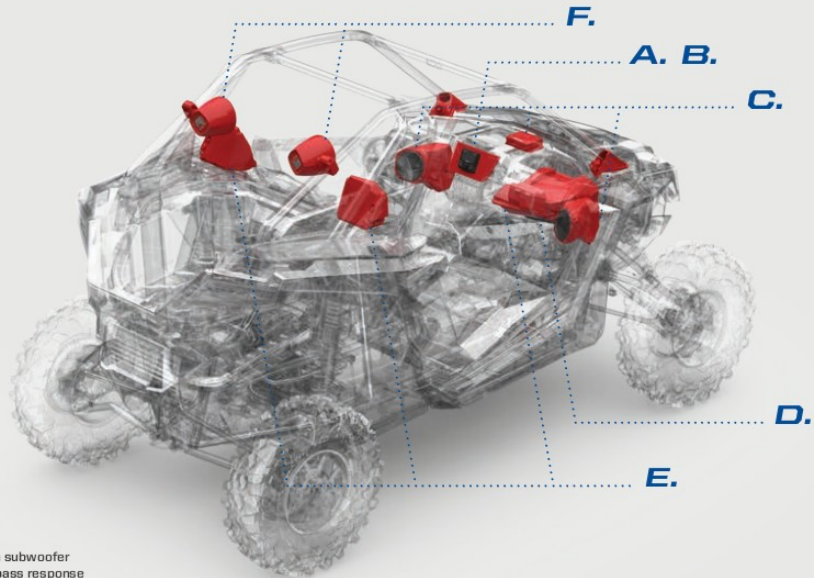

A. 7" RIDE COMMAND DISPLAY

» 2884072

PRO XP 4 '20-'21, PRO XP '20-'21
REQUIRES MOUNT KIT 2884073

SEE P. 50 FOR FULL RIDE COMMAND DETAILS



B. PMX-2 HEAD UNIT

- 6.86 cm full color display
- AM/FM/WB tuner*
- Pandora Control
- Bluetooth Connectivity
- Includes mount kit

» 2883964

PRO XP 4 '20-'21, PRO XP '20-'21
NOT COMPATIBLE WITH PRO XP ULTIMATE AND PREMIUM



C. STAGE 2 FULL RANGE AMPLIFIER AND FRONT UNDER-DASH SPEAKERS

- 400 watt full range amplifier
- 50 watt 16.51 cm component speakers with tweeters with enclosures

» 2883943

PRO XP 4 '20-'21, PRO XP '20-'21
STANDARD ON PRO XP ULTIMATE AND PREMIUM



D. STAGE 3 25.4 cm SUBWOOFER UPGRADE

- 400 watt 25.4 cm subwoofer with enclosure with grille
- 400 watt integrated subwoofer amplifier

» 2883857

PRO XP 4 '20-'21, PRO XP '20-'21



E. STAGE 4 25.4 cm SUBWOOFER WITH REAR COAXIAL SPEAKER UPGRADE

- 400 watt 25.4 cm subwoofer with enclosure and grille
- 400 watt integrated subwoofer amplifier
- 50 watt 16.51 cm coaxial speakers with enclosure and grilles

» 2884255

PRO XP 4 '20-'21, PRO XP '20-'21



F. REAR PODS USE WITH STAGE 2, STAGE 3 OR STAGE 4

- 50 watt 16.51 cm coaxial speakers with can-enclosures and mounting hardware and grilles
- Stage 2 and 3 require Audio Harness (2415152), sold separately

» 2883945

PRO XP 4 '20-'21, PRO XP '20-'21



> AUDIO

BUILD YOUR SOUND (CHOOSE THE PATH THAT MATCHES YOUR RZR)

FACTORY-INSTALLED

SKIP TO STEP 3



PRO XP
PREMIUM & ULTIMATE

2 PASSENGER

RIDE COMMAND
+
STAGE 2

4 PASSENGER

RIDE COMMAND
+
STAGE 2 AND
REAR SPEAKERS

NO FACTORY AUDIO

STEP 1

SELECT HEAD UNIT

RIDE
COMMAND

OR

PMX-2
HEAD
UNIT

2884072
PRO XP 4 '20-21, PRO XP '20-21

2883964
PRO XP 4 '20-21, PRO XP '20-21, NOT
COMPATIBLE WITH PRO XP ULTIMATE
AND PREMIUM

MOUNT KIT REQUIRED

2884073
PRO XP 4 '20-21, PRO XP '20-21
SEE P. 50 FOR FULL
RIDE COMMAND DETAILS

MOUNT KIT
INCLUDED

STEP 2

ADD AUDIO KIT

STAGE 2

FULL RANGE AMPLIFIER AND FRONT UNDER-DASH SPEAKERS

2883943

PRO XP 4 '20-21, PRO XP '20-21, STANDARD ON PRO XP ULTIMATE AND PREMIUM

STEP 3

UPGRADE AUDIO

STAGE 3

25.4 cm SUBWOOFER
UPGRADE

2883857

PRO XP 4 '20-21, PRO XP '20-21
NOT COMPATIBLE WITH STAGE 4

OR

STAGE 4

25.4 cm SUBWOOFER WITH
REAR COAXIAL SPEAKER
UPGRADE

2884255

PRO XP 4 '20-21, PRO XP '20-21
NOT COMPATIBLE WITH STAGE 3
ALL 4P MODELS WITH FACTORY AUDIO COME WITH REAR
SPEAKERS. NOT COMPATIBLE WITH STAGE 4.

+ / OR

REAR PODS

2883945

PRO XP 4 '20-21, PRO XP '20-21
ADD ONTO STAGE 2, STAGE 3 OR STAGE 4

REAR SPEAKER POD AUDIO HARNESS

2415152

REQUIRED TO ADD PODS TO STAGE 2 OR STAGE 3

PRO XP 4 '20-21, PRO XP '20-21

HARNESS NOT REQUIRED ON PRO XP 4 MODELS WITH
FACTORY INSTALLED REAR SPEAKERS

*The FM Frequency range is from 88 to 108 and only on the odds (i.e. 88.1, 88.3, etc).

PRO XP



> BUILD YOUR CAB

ADD COMFORT AND STYLE WITH END-TO-END PROTECTION

ADD A ROOF

Shield from harsh elements while adding style.

ADD A REAR PANEL

Maintain rear visibility while reducing rear air swirl.

ADD A WINDSHIELD

Protect yourself and passenger with optical clarity.



ADD DOORS

Keep the cab free of debris and water.

RECOMMENDED 2-PASSENGER CAB

2883928	POLY ROOF
2889019	FULL VENTED WINDSHIELD - GLASS
2883962	GLASS WINDSHIELD WIPER KIT
2884664	CANVAS UPPER HALF DOORS
2884658	INNER DOOR CLOSEOFF PANEL
2883757	POLY REAR PANEL

Both cab builds available on 2-passenger and 4-passenger vehicles.

RECOMMENDED 4-PASSENGER CAB

2883990-458	ALUMINUM ROOF
2884305	FULL VENTED WINDSHIELD - HARD COAT POLY
2884660-458	ALUMINUM DOORS
2884665	CANVAS UPPER HALF DOORS
2884147	POLY REAR PANEL

Both cab builds available on 2-passenger and 4-passenger vehicles.

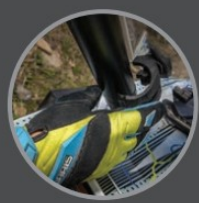
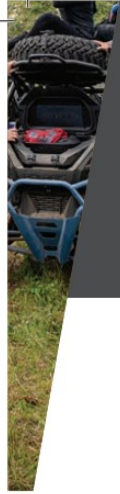

LOCK & RIDE

REVOLUTIONARY INSTALLATION

Lock & Ride clamps for easy on-off and eliminates the risk of cracking.



AIRTIGHT GASKET SEAL

Keep drafts and moisture out. Reduces ride chatter on full glass windshields.

POLARIS ENGINEERED ADVANTAGES

PRO XP

AUDIO

WINDSHIELDS
REAR PANELS

ROOFS, DOORS
HEATER

VEHICLE PROTECTION
BLINDINGS

STORAGE

MISC. MIRRORS
BLINDINGS

WINDSHIELDS
GLASS

HARD COAT POLY



WIPER READY

NEW
FULL VENTED WINDSHIELD - GLASS

• Double layer laminated, tempered glass windshield with steel powder coated frame and center adjustable vent

- » 2889019
PRO XP 4 '20-21, PRO XP '20-21
NOT COMPATIBLE WITH LIGHT POCKET ALUMINUM ROOF (2883961 & 2883991)



LOCK & RIDE
FULL VENTED WINDSHIELD - HARD COAT POLY

• Impact-resistant, long-lasting .64 cm durable hard coated polycarbonate

• Full protection with airflow vents that quickly open for cockpit ventilation

- » 2884305
PRO XP 4 '20-21, PRO XP '20-21
COMPATIBLE WITH ALUMINUM ROOF ONLY (2883961, 2883743, 2883991 OR 2883990)
- » 2883756
PRO XP 4 '20-21, PRO XP '20-21
COMPATIBLE WITH POLY SPORT ROOF ONLY (2883928 OR 2883946)



NEW **FULL AVAILABILITY**
TIP OUT WINDSHIELD - HARD COAT POLY

• Hard coated polycarbonate panel windshield offers 3 positions - closed, vented and full open

- Dual handles, keepers, and gas support struts
- » 2884662
PRO XP 4 '20-21, PRO XP '20-21
NOT COMPATIBLE WITH LIGHT POCKET ALUMINUM ROOFS



NEW
GLASS WINDSHIELD WIPER KIT

• Simple to control featuring a multi-speed dash mounted switch

• Includes a washer fluid reservoir

- » 2883962
PRO XP 4 '20-21, PRO XP '20-21
COMPATIBLE WITH GLASS WINDSHIELDS



LOCK & RIDE **TOP SELLER**
HALF WINDSHIELD - HARD COAT POLY, MID

• Impact-resistant, long-lasting .64 cm durable hard coated polycarbonate

• Provides protection and airflow into the cab

- 12 inches tall
- » 2884966
PRO XP 4 '20-21, PRO XP '20-21



NEW
LOCK & RIDE
HALF WINDSHIELD - HARD COAT POLY, LOW

• Provides added protection from the elements while allowing optimum airflow and visibility

- 5 inches tall
- » 2884746
PRO XP 4 '20-21, PRO XP '20-21

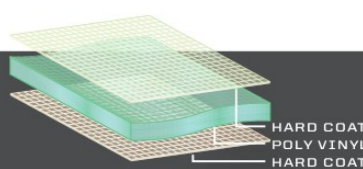
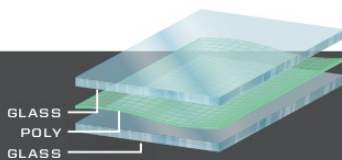

GLASS VS HARD COAT POLY

- Superior optical clarity [automotive level]
- Scratch resistant
- Seals tight
- Cold weather/heavy duty

- Lightweight, flexible, easy to store/remove
- Impact-resistant
- Hard Coat: 30x more scratch resistance than regular poly windshields

REAR PANEL



LOCK & RIDE
POLY REAR PANEL

• Drape formed 3 mm polycarbonate for lightweight, impact-resistant durability

• Maintains rear visibility while reducing rear air swirl from getting back into cockpit

• Fully compatible with all accessories

• If installed, Rear Audio Pods should project backwards

COLOR	2-SEAT	4-SEAT <small>(NOT SHOWN)</small>
CLEAR	2883757 PRO XP '20-21	2884147 PRO XP 4 '20-21

PRO XP

> ROOFS

POLY

POLY SPORT ROOF

- Durable light-weight polypropylene with contoured design for water run-off
- Maximum protection with full seal for a leak-free barrier and reduced chatter

COLOR	2-SEAT	4-SEAT <small>NOT SHOWN</small>
 MATTE BLACK	2883928	2883946
	PRO XP '20-21	PRO XP 4 '20-21

ALUMINUM

VS

HARD COAT POLY

- High protection strength
- Lower profile
- Sleek style

- Water run-off
- Pre-existing mounting features
- Lightweight

ALUMINUM

ALUMINUM ROOF

- .32 cm light-weight aluminum stamped sheet with full seal for a leak-free barrier and eliminating vibration
- Low-profile design, quick installation with maximum protection and durability from the harshest conditions

COLOR	2-SEAT	4-SEAT <small>NOT SHOWN</small>
 MATTE BLACK	2883743-458	2883990-458
 INDY RED	2883743-293	2883990-293
 BLUE METALLIC	2883743-751	2883990-751
 ZENITH BLUE	2883743-849	2883990-849
	PRO XP '20-21	PRO XP 4 '20-21

LIGHT POCKET ALUMINUM ROOF

- .32 cm light-weight aluminum stamped sheet with full seal for a leak-free barrier and eliminates vibration
- Low-profile with light pocket
- Quick installation with maximum protection and durability from the harshest conditions
- Not compatible with Full-Vented Glass Windshield (2889109) and Tip Out Windshield - Hard Coat Poly (2884662)

COLOR	2-SEAT	4-SEAT <small>NOT SHOWN</small>
 MATTE BLACK	2883961-458	2883991-458
	PRO XP '20-21	PRO XP 4 '20-21

ADD THE 71.12 cm RIGID SINGLE ROW LED LIGHT BAR. FITS PERFECTLY INTO ROOF POCKET. P. 15 FOR DETAILS



VISIONARY DESIGN

Relentless attention to detail delivering extraordinary style and function for the ultimate ride.



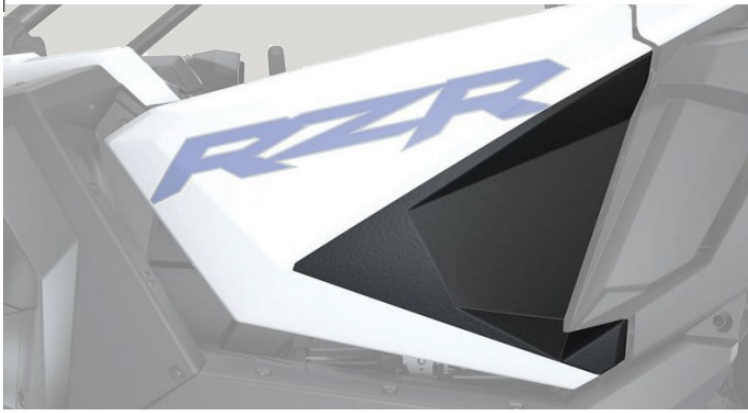

> DOORS

DOOR CLOSEOFFS TOP SELLER

- Lightweight plastic door closeoffs to provide rider protection from mud, rock and water
- Quick installation for a seamless fit into door opening
- Retains ventilation in front

▶ 2883765

PRO XP '20-21

DOOR CLOSEOFFS COME STOCK ON PRO XP 4.

NV ALUMINUM DOORS

- 12-gauge thick stamped aluminum with full lower coverage and seal to keep out water, mud, dust, and debris
- Uses factory door frames, 4-seat option provides an additional seal between front and rear doors
- Complete seal to block dust, water, and mud
- Compatible with Inner Door Closeoff Panel (2884658 & 2884831) and Canvas Upper Half Doors (2884664 & 2884665)

COLOR	2-SEAT <small>NOT SHOWN</small>	4-SEAT
■ MATTE BLACK	2884659-458 PRO XP '20-21	2884660-458 PRO XP 4 '20-21 <small>NOT COMPATIBLE WITH LOW PROFILE ROCK SLIDERS (2883987)</small>



NV INNER DOOR CLOSEOFF PANEL

- Vacuum formed polyethylene with full lower coverage and seal that keeps out water, mud, dust, and debris
- Built in armrest
- 2-seat option maintains color accent boomerang
- Compatible with Door Closeoffs (2883765) and Aluminum Doors (2884659-458 & 2884660-458)
- ▶ 2-SEAT • 2884658
PRO XP '20-21
NOT COMPATIBLE WITH LOW PROFILE ROCK SLIDERS (2883760)
- ▶ 4-SEAT • 2884831
PRO XP 4 '20-21

NV CANVAS UPPER HALF DOORS

- High quality compression molded doors nest into thermoformed high-density polyethylene side shrouds for excellent sealing
- Includes zip-down 30 gauge clear vinyl windows
- Provides profiled cab edge for superior fit and finish
- Includes seals for key closeoff areas
- See P. 10 for recommended cab setup
- ▶ 2-SEAT • 2884664
PRO XP '20-21
- ▶ 4-SEAT • 2884665
PRO XP 4 '20-21

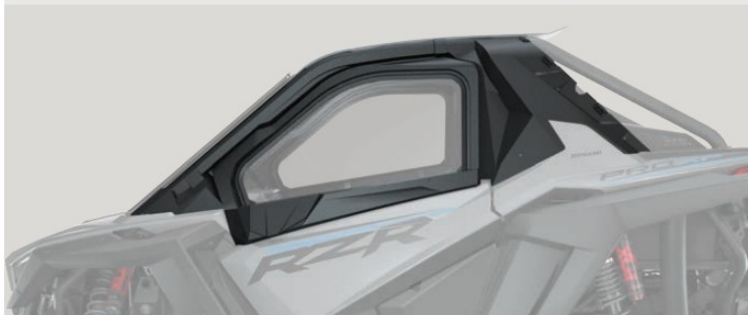

> HEATER

NV HEATER KIT

- Connects to Polaris Pulse busbar to provide reliable, steady heat to your cab with fan speed and temperature control
- Closeable driver and passenger floor vents and electronic demist vent shutoff

▶ 2884386

PRO XP 4 '20-21, PRO XP '20-21

PRO XP

AUDIO

WINDSHIELDS
GRAB PANELS

ROCK DOORS
HEATER

VEHICLE PROTECTION
BLINDINGS

STORAGE

MISC. MIRRORS
B/SWITCHES

CHOOSE YOUR DOOR

ADD DOOR ACCESSORIES

PRO XP

> BUMPERS / FENDER FLARES



LOW PROFILE BUMPER

• Durable, powder-coated 1.5" - 1.75" tube steel with sleek lower profile

COLOR	FRONT	REAR
MATTE BLACK	2883746-458	2883748-458
INDY RED	2883746-293	2883748-293
BLUE METALLIC	2883746-751	2883748-751

PRO XP 4 '20-21, PRO XP '20-21



HIGH COVERAGE BUMPER

• Durable 12 gauge powder-coated steel with extended high-coverage design for maximum vehicle protection

COLOR	FRONT	REAR
MATTE BLACK	2883749-458	2884189-458
INDY RED	2883749-293	2884189-293
BLUE METALLIC	2883749-751	2884189-751
ZENITH BLUE	2883749-849	2884189-849

PRO XP 4 '20-21, PRO XP '20-21



INTEGRATED WINCH
SEE P. 19



RIGID 15.24 cm
LIGHT BAR
SEE RIGHT PAGE

Next-level style & function. Front bumpers are designed to effortlessly integrate a winch or 15.2 cm RIGID light bar. No extra mounts required.



FULL COVERAGE FENDER FLARES

- Covers the rear body opening to prevent mud from flying into the vehicle and has a removable mud flap
- Maximum protection with 6 inches of additional coverage and extended mud flaps
- Front and rear included

2884685

PRO XP 4 '20-21, PRO XP '20-21

> ROCK SLIDERS



10 GAUGE STAMPED STEEL
NO LOSS IN GROUND CLEARANCE

LOW PROFILE

COLOR	2-SEAT	4-SEAT
MATTE BLACK	2883760-458	2883987-458
INDY RED	2883760-293	2883987-293
BLUE METALLIC	2883760-751	2883987-751

PRO XP '20-21

NOT COMPATIBLE WITH INNER DOOR CLOSE OFF PANELS (2884658)

PRO XP 4 '20-21

NOT COMPATIBLE WITH ALUMINUM DOORS (2884660-458)



4.5cm STEEL TUBE CONSTRUCTION
EXTENDS FROM MACHINE FOR MAX PROTECTION THROUGH ROUGH TERRAIN

KICK-OUT

COLOR	2-SEAT	4-SEAT
MATTE BLACK	2883997-458	2883988-458
INDY RED	2883997-293	2883988-293
BLUE METALLIC	2883997-751	2883988-751

PRO XP '20-21

PRO XP 4 '20-21

SEAMLESS INSTALLATION

Easily mount rock sliders with two piece mount. Reusable anchors mount to built-in dedicated chassis mount standard on your machine.



CLOSED/
UNLOCKED



OPEN/
LOCKED

> LIGHTING



NEW ACCENT LIGHT

- Durable construction to resist dust and water out on the trails
- Front fascia LED accent light

2884346

PRO XP 4 '20-21, PRO XP '20-21
STANDARD ON PREMIUM AND ULTIMATE TRIMS



RIGID

ADVANCED TECH

RIGID lights are driven by Aluminum PCB Smart Boards, 6063-T5 aircraft aluminum extruded housings and Tiger Drylac UV protection polyester powdercoating.

EXCLUSIVE OPTICS

RIGID invests heavily in optical science and has patented multiple optics and optics systems, maximizing light output and efficiency.

LIGHT BAR OPTIONS

BRAND SIZE TYPE	RAW LUMENS	PN	FITMENT
RIGID 15.2 cm E-SERIES	9,504	2883948	PRO XP 4 '20-21, PRO XP '20-21
RIGID 71.1 cm SR-SERIES	17,556	2884074	PRO XP 4 '20-21, PRO XP '20-21
RIGID 81.3 cm SR-SERIES	20,064	2883947	PRO XP 4 '20-21, PRO XP '20-21



NEW RIGID CHASE LIGHT

- Bright, daylight visible lighting with eleven selectable modes, including white scene lighting for accessing cargo bed in the dark
 - Connects into brake light system for additional high mount brake light
- 2884359
PRO XP 4 '20-21, PRO XP '20-21
MOUNT (2884896) AND HARNESS (2889034)
REQUIRED, SOLD SEPARATELY.



MOUNTS IN WINCH POCKET FOR SEAMLESS INTEGRATION IN FRONT BUMPERS
SEE LEFT PAGE FOR DETAILS



DESIGNED FOR USE WITH LIGHT POCKET ALUMINUM ROOF
SEE P. 12 FOR DETAILS

HARNESSES & MOUNT KITS

MODEL	LIGHT BAR SET-UPS		NEW CHASE LIGHT
	1 LIGHT IN 1 LOCATION ON 1 SWITCH	2 LIGHTS IN 2 LOCATIONS ON 2 SWITCHES	
PRO XP 4 '20-21 PRO XP '20-21	POLARIS PULSE LIGHT BAR HARNESS 2883949	POLARIS PULSE LIGHT BAR HARNESS (x2) 2883949	CHASE LIGHT MOUNT KIT 2884896 CHASE LIGHT HARNESS 2889034

POLARIS ENGINEERED ADVANTAGES



PLUG & PLAY ELECTRICAL

POLARIS PULSE IS A REVOLUTIONARY way to provide power to your vehicle, and makes adding electrical accessories a snap.

SEE P. 48 FOR FULL LIGHT OPTIONS

PRO XP

AUDIO

WINDSHIELDS
GREAR PANELS

ROOF, DOORS
GREATER

VEHICLE PROTECTION
& LIGHTING

STORAGE

MISC. MIRRORS
& SWITCHES

PRO XP



HAVE-IT-ALL

> STORAGE

ACCESSORY	PN
28 L NORTHSTAR COOLER - GRAPHITE	2883424
LOCK & RIDE 28 L NORTHSTAR COOLER BRACKET	2884070
LOCK & RIDE 40L REAR CARGO STORAGE BOX	2883752
PIVOTING SPARE TIRE CARRIER	2884907-458
7.25L DOOR STORAGE BAG (not shown)	2884304
9.5L SHOULDER STORAGE BAG (not shown)	2884286

LOCK & RIDE

70L FORWARD CARGO STORAGE BOX TOP SELLER

- Protect your gear in the 70L Forward Cargo Storage Box with lockable latches and side handles
- Durable Polypropylene engineered to seal out dust and water
- Lock & Ride secures strongly to cargo bed

» 2883751
PRO XP 4 "20-21, PRO XP "20-21



FIT:
2 Full-Size Helmets
Tool Kit
Jacket/Coat
Food & Drinks

LOCK & RIDE

40L REAR CARGO STORAGE BOX TOP SELLER

- Protect your gear in the 40L Rear Cargo Storage Box with lockable latches and side handles
- Durable Polypropylene engineered to seal out dust and water
- Lock & Ride secures strongly to cargo bed

» 2883752
PRO XP 4 "20-21, PRO XP "20-21



FIT:
Sleeping Bag
First Aid Kit
Snacks
Sunscreen

FORWARD CARGO AND REAR CARGO STORAGE BOXES NEST PERFECTLY TOGETHER

REAR CARGO STORAGE BOX AND 28 L NORTHSTAR COOLER NEST PERFECTLY TOGETHER





LOCK & RIDE

NEW

MULTI-PASSENGER REAR SEAT CARGO BOX

- 72 liter capacity cargo box with a single wall base and a dual wall lid that seals out dust and water
- Uses Lock & Ride mounting for easy installation and removal
- Includes a drain plug and mounting hardware and includes place to add padlock for increased security
- Compatible with Premium/Ultimate models with flip forward/fold flat storage only
- Fits full size ORV helmet

» 2884666
PRO XP 4 '20-21



NEW **FULL AVAILABILITY**

PIVOTING SPARE TIRE CARRIER **TOP SELLER**

- Secure mounting with single handed release lever with dual latches
- Steel mounts and rack
- Holds a maximum tire size of 32" and can support 75 lbs of weight
- New single hand release mechanism

» 2884907-458
PRO XP 4 '20-21, PRO XP '20-21

LOCK & RIDE

NEW

28 L REAR COOLER

- Lid locks securely in place with rubber latches to protect cargo
- Provides plenty of storage without weighing you down
- Keeps your food, beverages, and bait fresh while out on the trails
- Nests with forward storage bin

» 2884623
PRO XP 4 '20-21, PRO XP '20-21



28 L COOLER

- Nests with rear storage bin
- » GRAPHITE • 2883424
- » DESERT • 2881315
PRO XP 4 '20-21, PRO XP '20-21



LOCK & RIDE

28 L NORTHSTAR COOLER BRACKET

» 2884070
PRO XP 4 '20-21, PRO XP '20-21

SEE P. 72 FOR FULL DETAILS ON
POLARIS NORTHSTAR COOLERS



9.5L SHOULDER STORAGE BAG

- Keep your belongings safe and secure in the 9.5L Shoulder Storage Bag
- Molded sides, lid inserts, waterproof zipper and a nylon mesh pocket for versatile storage options
- Easy install and quick access with a sleek look within the cockpit

» 2884286
PRO XP 4 '20-21, PRO XP '20-21
FITS BETWEEN REAR SEATS OF PRO XP 4 ONLY



FIT:
Flashlight
Snacks
Sunglasses
Bug Spray

7.25L DOOR STORAGE BAG

- 7.25L quick reach access to keep supplies and gear secure
- Waterproof zipper keeps everything enclosed clean and dry
- Molded face with EVA carbon fiber vinyl cover design

» 2884304
PRO XP 4 '20-21, PRO XP '20-21
FITS ON FRONT DOORS OF PRO XP 4 ONLY
NOT COMPATIBLE WITH INNER DOOR
CLOSEOFF PANEL



FIT:
Cell Phone
Gloves
Sunscreen

SEE P. 89 FOR STRAPS AND COVER

PRO XP

AUDIO

WINDSHIELDS
GRAB PANELS

ROOF DOORS
SHOWER

VEHICLE PROTECTION
BLINDING

STORAGE

MISC. MIRRORS
BLINDING

PRO XP



> MISC

NEW ASSAULT GRILL

- Constructed from high quality aluminum for lasting quality
- Enhances your RZR's style with sleek colored badging

COLOR	FRONT
INDY RED	2884646-293
BLUE METALLIC	2884646-751

PRO XP 4 '20-21, PRO XP '20-21



NEW FALL AVAILABILITY SGB PARTICLE SEPARATOR

- Separates out over 94% of dust before it reaches the air filter
- Integrated hidden design in fender stays out of sight
- Variable speed fan based on engine speed to keep noise levels low

» 2884629

PRO XP 4 '20-21, PRO XP '20-21



NEW SECONDARY BATTERY MOUNT KIT

- Provides longer lasting 12 V output
- Battery sold separately

» 2884347

PRO XP '20-21

» 2884391

PRO XP 4 '20-21



> MIRRORS

NEW ASSAULT BOMBER MIRRORS

- Billet aluminum construction to endure even the toughest trail conditions
- Colored accent bezels enhance your ride's style

INDY RED 2884624-293

BLUE METALLIC 2884624-751

PRO XP 4 '20-21, PRO XP '20-21



FOLDING SIDE MIRRORS TOP SELLER

- Installs in minutes and integrates into a designated mounting position
- Laminated safety glass for excellent scratch resistance

» 2883762

PRO XP 4 '20-21, PRO XP '20-21



PREMIUM CONVEX REAR VIEW MIRROR TOP SELLER

- Installs in minutes and integrates into a designated mounting position
- Laminated safety glass for excellent scratch resistance

» 2883763

PRO XP 4 '20-21, PRO XP '20-21





PRO XP

AUDIO

WINDSHIELDS
& REAR PANELS

ROOF, DOORS
& HEATER

VEHICLE PROTECTION
& LIGHTING

STORAGE

MISC. MOUNTS
& WINCHES

> WINCHES



FEATURES	 PRO HEAVY DUTY SERIES	
RAPID ROPE RECOVERY	STANDARD	
AUTO STOP TECHNOLOGY	STANDARD	
WINCH LINE	SYNTHETIC ROPE	
FAIRLEAD	ALUMINUM	
CONTROL	WIRELESS & WIRED STANDARD	
MODEL	2,721 kg	2,041 kg
PRO XP 4 / PRO XP '20-21 <i>Includes both wired and wireless remote</i>	2883759	2883758
REPLACEMENT PARTS SYNTHETIC ROPE  <ul style="list-style-type: none"> 2,721 kg SERIES - 50 ft. » 2878888 2,041 kg SERIES - 50 ft. » 2879187 		

SEE P. 76 FOR ADDITIONAL WINCH INFORMATION

PRO XP



ACCESSORIZE YOUR PRO XP
TO MAKE IT YOURS



PRO XP

AUDIO

WINDSHIELDS
& REAR PANELS

ROOF, DOORS
& HEATER

VEHICLE PROTECTION
& LIGHTING

STORAGE

MISC. MIRRORS
& WINCHES

TURBO S & XP



TURBO S

LOCK & RIDE HALF WINDSHIELD - HARD COAT POLY - TINTED	P.24
LOWER DOOR INSERTS	P.27
BARRICADE CAGE SYSTEM (NO EXTENSION)	P.28
FRONT & REAR DESERT BUMPER - BLACK	P.29
MIRRORS	P.31
RIGID SR-SERIES 81.3 cm COMBO LIGHT BAR + ACCENT LIGHTING	P.49
PRO ARMOR WHEELS & TIRES	P.54
POLARIS PRO HD 2,041 kg WINCH	P.76

XP TURBO



XP 1000

GRAPHIC SPORT ROOF - INDY RED	P.26
LOCK & RIDE HALF WINDSHIELD - HARD COAT POLY - TINTED	P.24
FRONT & REAR DESERT BUMPER - INDY RED	P.29
LOW PROFILE ROCK SLIDERS - INDY RED	P.29
MIRRORS	P.31
RIGID LIGHTING + TRAILBLAZER HEADLIGHTS	P.49

RS1



ALUMINUM ROOF	P. 26
LOCK & RIDE FULL WINDSHIELD - HARD COAT POLY	P. 24
REAR RACE NET	P. 25
FRONT & REAR DESERT BUMPER - TITANIUM METALLIC	P. 29
FULL COVERAGE FENDER FLARES	P. 71
PRO ARMOR DUAL-ROW 76.2 cm COMBO LIGHT BAR	P. 49
PRO ARMOR WHEELS & TIRES	P. 54
POLARIS PRO HD 2,041 kg WINCH	P. 76



ALUMINUM ROOF	P. 32
LOCK & RIDE FULL WINDSHIELD - HARD COAT POLY & REAR PANEL	P. 32
EXTREME KICK-OUT ROCKSLIDERS	P. 32
RZR SUB-ZERO 4 HARNESSSES	P. 32
PRO ARMOR 50.8 cm DUAL-ROW COMBO LIGHT BAR	P. 48
PRO ARMOR WHEELS & TIRES	P. 54
POLARIS PRO HD 2,041 kg WINCH	P. 76
SPORT LOW PROFILE BUMPER - FRONT	P. 33
EXTREME DUTY BUMPER	P. 32
IN-COCKPIT STORAGE	P. 33

POLARIS RZR

MAKE IT YOURS

Whatever your style, however you ride Polaris Engineered Accessories help you create your one-of-a-kind RZR.

ESSENTIALS TO KEEP YOU RIDING LONGER

- Windshields P. 24
- Rear Panels P. 25
- Roofs P. 26
- Doors P. 27
- Protection P. 28

ADD STYLE. ADD FUNCTION. ADD YOU.

- Audio P. 52
- Lighting P. 48
- Wheels & Tires P. 54
- Winches P. 76
- Storage P. 30
- Mirrors P. 31

THE RIGHT STUFF TO MAINTAIN YOUR RZR

- Maintenance P. 80
- Oil & Lubricants P. 82

EVERYTHING YOU NEED TO GEAR UP

- Riding Gear P. 90
- Casualwear P. 96

TURBO S & XP

WINDSHIELDS
& REAR PANELS

ROOFS & DOORS

VEHICLE PROTECTION
& WINCHES

STORAGE
& MIRRORS

RZR R91

TURBO S & XP



> WINDSHIELDS

HARD COAT POLY



LOCK & RIDE TOP SELLER

VENTED FULL WINDSHIELD - HARD COAT POLY

- Impact-resistant, long-lasting .64 cm durable hard coated polycarbonate
- Full protection with airflow vents that quickly open for cockpit ventilation

» 2884330

XP TURBO '19-21, XP 4 TURBO '19-21, XP 4 1000 '19-21, XP 1000 '19-21



LOCK & RIDE

FULL WINDSHIELD - HARD COAT POLY

- Durable, optical-grade polycarbonate for maximum impact resistance

» 2884018

XP TURBO '19-21, XP 4 TURBO '19-21, XP 4 1000 '19-21, XP 1000 '19-21



LOCK & RIDE TOP SELLER

HALF WINDSHIELD - HARD COAT POLY - TINTED

- Enhanced curved styling prevents collecting mud or dirt
- Innovative tint technology helps reduce glare and improve visibility
- Equipped with self-adjusting clamps
- 7.2" tall

» 2883135

TURBO S '18-21, XP TURBO '19-21, 4 TURBO S '19-21, XP 4 TURBO '19-21, XP 4 1000 '19-21, XP 1000 '19-21

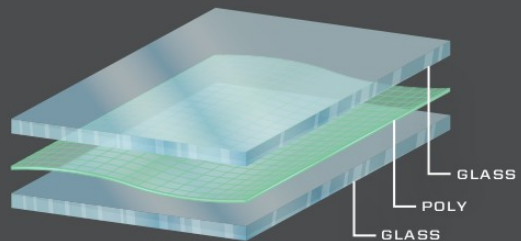
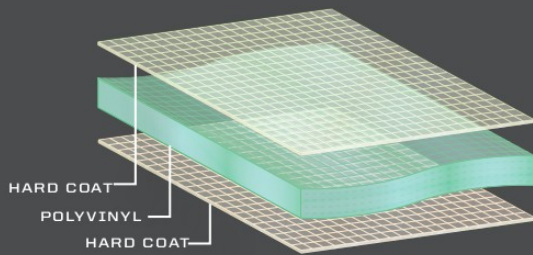

HARD COAT POLY

VS

GLASS

- Lightweight, flexible, easy to store/remove
- Impact-resistant
- Hard Coat: 30x more scratch resistance than regular poly windshields

- Superior optical clarity (automotive level)
- Scratch resistant
- Seals tight
- Cold weather / Heavy duty

POLARIS ENGINEERED ADVANTAGES



LOCK & RIDE

REVOLUTIONARY INSTALLATION

Lock & Ride clamps for easy on-off and eliminates the risk of cracking.



GASKET SEAL

Keep drafts and moisture out. Reduces ride chatter. Full airtight seal on glass windshields.

TURBO S & XP

WINDSHIELDS & REAR PANELS

ROOFS & DOORS

VEHICLE PROTECTION & BUMPERS

STORAGE & MIRRORS

RZR RSL

GLASS



FULL WINDSHIELD - GLASS

- Double layer laminated, tempered glass windshield
- Fits seamlessly with the roof & hood of your DRV to form a complete full seal for maximum durability and to reduce chatter

» 2884331
XP TURBO '19-21, XP 4 TURBO '19-21, XP 4 '1000 '19-21, XP 1000 '19-21



ADD A REAR PANEL TO REDUCE THE DUST SWIRL



> REAR PANELS



LOCK & RIDE TOP SELLER
REAR PANEL - POLY

» 2881614
XP TURBO '15-21, XP 4 TURBO '16-21, XP 4 '1000 '14-21, XP 1000 '14-21
NOT COMPATIBLE WITH EXTREME AUDIO PODS (2883739)



REAR PANEL - MESH

» 2879507
XP TURBO '15-21, XP 4 TURBO '16-21, XP 4 '1000 '14-21, XP 1000 '14-21



REAR RACE NET

» 2879936
XP TURBO '15-21, XP 4 TURBO '16-21, XP 4 '1000 '14-21, XP 1000 '14-21

SEE P. 32 FOR



TURBO S & XP

> ROOFS

ALUMINUM VS POLY

- High protection strength
- Lower profile
- Sleek style

- Water run-off channels
- Quick on/off install
- Lightweight

POLY

LOCK & RIDE

POLY SPORT ROOF TOP SELLER

- Rigid injection-molded design to eliminate warping in high-heat conditions
- Integrated mounting locations for lighting
- Rugged, textured polyethylene construction for impact and abrasion resistance
- Not compatible with upper or full doors

COLOR	2-SEAT	4-SEAT <small>NOT SHOWN</small>
■ BLACK	2883073	2883074
	XP TURBO '15-'21, XP 1000 '14-'21	XP 4 TURBO '16-'21, XP 4 1000 '14-'21

GRAPHIC SPORT ROOF

- Weighs only 5 kg (30% lighter than aluminum)
- Won't bend or break upon impact with debris or other obstacles
- Sunroof lets in sunlight while keeping you shaded from the heat

COLOR	2-SEAT	4-SEAT <small>NOT SHOWN</small>
■ BLACK	2881206	2881935
■ INDY RED	2881607	2881936
■ BRIGHT WHITE	2881608	2881937
	XP TURBO '15-'21, XP 1000 '14-'21	XP 4 TURBO '16-'21, XP 4 1000 '14-'21

ALUMINUM

ALUMINUM ROOF TOP SELLER

- Seals to the vehicle frame for the best protection and great integration with other RZR accessories
- Strong and durable 5051 aluminum construction for long-lasting, reliable protection

COLOR	2-SEAT	4-SEAT <small>NOT SHOWN</small>
■ BLACK	2881582-458	2881592-458
■ INDY RED	2881582-293	2881592-293
	XP TURBO '15-'21, XP 1000 '14-'21	XP 4 TURBO '16-'21, XP 4 1000 '14-'21
■ MATTE BLACK	2884086-458	2884087-458
	TURBO S '18-'21	4 TURBO S '19-'21

CANVAS

CANVAS ROOF NOT SHOWN

- Durable, heavyweight 652 g polyester canvas construction
- Mold-resistant and UV-stable to resist fading for long-lasting performance
- Installs quickly and easily with provided straps

COLOR	2-SEAT	4-SEAT
■ BLACK	2880561	2880610
	XP TURBO '15-'21, XP 1000 '14-'21	XP 4 TURBO '16-'21, XP 4 1000 '14-'21



SEE P. 32 FOR





> DOORS

ALUMINUM DOORS

- Single-piece stamped aluminum maximizes quality, fit and finish
- More cockpit room with wide berth
- Gasket design eliminates rattling and creates a firm seal
- Graphics not included

2-SEAT • 2879510

TURBO S '19-21, XP TURBO '15-21, XP 1000 '14-21

4-SEAT • 2879943

4 TURBO S '19-21, XP 4 TURBO '16-21, XP 4 1000 '14-21



LOWER DOOR INSERTS TOP SELLER

- Covers the bottom of the door opening, shutting out water and dust
- Durable plastic construction with steel frame

2-SEAT • 2879509

TURBO S '19-21, XP TURBO '15-21, XP 1000 '14-21

4-SEAT • 2879942

4 TURBO S '19-21, XP 4 TURBO '16-21, XP 4 1000 '14-21



CANVAS UPPER DOORS

- Easy install with stock door panels using pre-designated mounting points
- 23 oz mold resistant, UV stable and crack-resistant materials for lasting durability & protection
- Install with roof, full windshield, rear panel and lower doors to create a full cab enclosure for colder weather and/or increased protection
- Not compatible with Poly Sport Roof or Audio Roof options

2-SEAT • 2884333

XP TURBO '19-21, XP 1000 '19-21

4-SEAT • 2884332

XP 4 TURBO '19-21, XP 4 1000 '19-21

TURBO S & XP

WINDSHIELDS
& REAR PANELS

ROOFS & DOORS

VEHICLE PROTECTION
& BUMPERS

STORAGE
& MIRRORS

RZR RS1

TURBO S & XP

> BUMPERS & ROCK SLIDERS



> CAGE SYSTEM

BARRICADE CAGE

CAGE

- ROHVA-compliant, single-piece, fully-welded roll cage
- 7.6 cm lower profile than stock cage for true custom look
- High-quality powdercoat and E-coat finish
- Works with Polaris Poly Half Windshield (2883135)

■ BLACK 2881986-458

TURBO S '18-21, XP TURBO '15-21, XP 1000 '14-21
 REQUIRED SOLD SEPARATELY: SUBZERO 4-PT HARNESS:
 DRIVER (2882281) AND PASSENGER (2882282) OR CLICK 6 HARNESS:
 DRIVER (2882244) AND PASSENGER (2882245)

ROOF

- Protect yourself from the elements while adding style and color to your custom cage
- Easy installation with integrated fastening points
- High-quality powdercoated finish
- Lightweight aluminum

■ BLACK 2882172-458

■ INDY RED 2882172-293

TURBO S '18-21, XP TURBO '15-21, XP 1000 '14-21
 REQUIRES BARRICADE CAGE (2881986-458), SOLD SEPARATELY



DESERT BUMPER TOP SELLER

- Perfect for: Heavy-duty protection with aggressive style and mounting for lights



COLOR	FRONT	REAR
BLACK	2884019-458	2884020-458
INDY RED	2884019-293	2884020-293
TITANIUM	2884019-632	2884020-632
SKY BLUE	2884019-737	2884020-737

XP TURBO '15-21, XP 4 TURBO '16-21, XP 4 1000 '14-21, XP 1000 '14-21

COLOR	FRONT	REAR
BLACK	2883132-458	2883133-458

TURBO S '18-21, 4 TURBO S '19-21

LOW PROFILE ROCK SLIDERS - STEEL

- Plated steel construction, durable powdercoat finish
- Easy installation with expanded anchor mount



COLOR	2-SEAT	4-SEAT
BLACK	2879498-458	2879940-458
INDY RED	2881587-293	2881593-293
SKY BLUE	2881587-737	2881593-737

2-SEAT: TURBO S '18-21, XP TURBO '15-21, XP 1000 '14-21
4-SEAT: 4 TURBO S '19-21, XP 4 TURBO '16-21, XP 4 1000 '14-21

EXTREME KICK-OUT ROCK SLIDERS - STEEL TOP SELLER

- Rugged steel protection and race-inspired styling
- Low-profile mounting location will not diminish ground clearance



COLOR	2-SEAT	4-SEAT
BLACK	2879456-458	2882079-458
INDY RED	2881586-293	2882079-293
SKY BLUE	2881586-737	2882079-737

2-SEAT: TURBO S '18-21, XP TURBO '15-21, XP 1000 '14-21
4-SEAT: 4 TURBO S '19-21, XP 4 TURBO '16-21, XP 4 1000 '14-21

ANCHOR MOUNTS

Tougher than conventional nuts and bolts, Expansion Anchor Mounts are engineered into every RZR, allowing for a fast install.

BUMPER ANCHOR PACK

- 4 Anchors and 2 Bumper End Caps included
- » 2205114



> WINCHES

FEATURES	PRO PRO HEAVY DUTY SERIES	HD HEAVY DUTY SERIES	
RAPID ROPE RECOVERY	STANDARD	NOT AVAILABLE	
AUTO STOP TECHNOLOGY	STANDARD	OPTION	
WINCH LINE	SYNTHETIC ROPE	STEEL CABLE	
FAIRLEAD	ALUMINUM	STEEL ROLLER	
CONTROL	WIRELESS STANDARD, WIRED OPTION	WIRED STANDARD, WIRELESS OPTION	
MODEL	2,041 kg	1,588 kg	ADD REQUIRED CABLES
XP 4 1000 '14-21 XP 4 TURBO '16-21 XP 1000 '14-21 XP TURBO '15-21	2882240	2881671	XP 4 1000 / XP 4 TURBO '19-21, XP 1000 / XP TURBO '19-21 REQUIRE WINCH COVER KIT 2884118
TURBO S '18-21 4 TURBO S '19-21	2883828		INCLUDED WITH WINCH
RZR RS1 '18-21	2883825		INCLUDED WITH WINCH

EXTREME BUMPER (2883783-458) REQUIRED, SOLD SEPARATELY

See page 49 for Busbar Harness Fitment

REPLACEMENT PARTS

SYNTHETIC ROPE	STEEL CABLE
2,041 kg SERIES » 2879187	1,588 kg SERIES » 2878890 WORKS WITH 2881671

UPGRADE YOUR CONTROLS

WIRED REMOTE CONTROL		
• Must order remote handle and socket together		
» REMOTE HANDLE 4013466	» SOCKET 4017102	» SOCKET 4014228
WORKS WITH 2882240, 2883828, 2883825	WORKS WITH 2883825	WORKS WITH 2882240, 2883828

UPGRADE YOUR HD WINCH

WIRELESS REMOTE	AUTO STOP UPGRADE
• Up to 15 m range with LED indicator	• Billeted aluminum
• Direct plug & play operation	• Replaces stock fairlead
» 2879316	» 2881693 SYNTHETIC ROPE REQUIRED

TURBO S & XP

WINDSHIELDS & REAR PANELS

ROOFS & DOORS

VEHICLE PROTECTION & WINCHES

STORAGE & MIRRORS

RZR RS1

TURBO S & XP

> STORAGE



LOCK & RIDE **COOLER BOX** TOP SELLER

- One-piece rotomolded construction for extreme durability
- Lid locks securely in place with rubber latches to protect cargo
- Heavy-duty hinges and weatherproof seal block moisture and dust
- Keeps food and beverages cool for 48+ hours, depending on conditions
- UV-fade resistant
- Installs quickly and easily without tools
- Easy to carry with integrated grab handles

» 45.4 L • 2881555

TURBO S '18-21, XP TURBO '15-21, 4 TURBO S '19-21, XP 4 TURBO '16-21, XP 4 1000 '14-21, XP 1000 '14-21

BED D-RINGS

» 2877460

TURBO S '18-21, XP TURBO '15-21, 4 TURBO S '19-21, XP 4 TURBO '16-21, XP 4 1000 '14-21, XP 1000 '14-21



LOCK & RIDE **D-RINGS**

» 2881544



LOCK & RIDE **EXPANSION ANCHOR**

» 2876420

LOCK & RIDE **QUICKSTRAP**

- Quickest, most secure way to mount Polaris accessories

» 2882187



LOCK & RIDE **CARGO BOX** TOP SELLER

- Integrated rear cargo box touting 65 liters of storage
- Secure latching lid with taut rubber strap tie-downs
- Lightweight design integrates seamlessly with RZR Rear Cargo Bed
- Includes all mounting hardware for complete installation

» 2881193

TURBO S '18-21, XP TURBO '15-21, 4 TURBO S '19-21, XP 4 TURBO '16-21, XP 4 1000 '14-21, XP 1000 '14-21



OVERHEAD BAG

» 2879516

XP 4 1000 '14-21, XP 4 TURBO '16-21, XP 1000 '14-21, XP TURBO '15-21



UPPER DOOR STORAGE BAG

» 2880612

TURBO S '18-21, XP TURBO '15-21, 4 TURBO S '19-21, XP 4 TURBO '16-21, XP 4 1000 '14-21, XP 1000 '14-21

ONLY COMPATIBLE WITH FRONT DOORS OF ALL MODELS



LOWER DOOR STORAGE BAG

» 152 cm 2880613

TURBO S '18-21, XP TURBO '16-21, 4 TURBO S '19-21, XP 4 TURBO '16-21, XP 4 1000 '14-21, XP 1000 '14-21

REQUIRES LOWER DOOR 2879509 OR 2879942
ONLY COMPATIBLE WITH FRONT DOORS OF ALL MODELS



SPARE TIRE CARRIER

- Easily carry a spare tire without sacrificing valuable cargo box capacity
- Mount in less than 5 minutes to the rear cab frame extension using four fasteners and an integrated lug wrench that is built into the handle
- Remove two of the quick-release pins and you can pivot the Tire Carrier up to gain great access to the contents of the cargo box

» 2883487

TURBO S '18-21, 4 TURBO S '19-21



SPARE TIRE CARRIER TOP SELLER

» 2879464

XP TURBO '15-21, XP 4 TURBO '16-21, XP 1000 '14-21, XP 4 1000 '14-21

SEE P. 32 FOR

POLARIS
RZR
R31

> MIRRORS



FOLDING SIDE MIRRORS TOP SELLER

- Includes left and right mirrors with mounting brackets and hardware
- Hinges feature breakaway design for tight trail conditions and easy trailering
- Mounts directly to factory roll cage at the bolt location, works with windshields and doors

» 2881198

TURBO S '18-21, XP TURBO '15-21, 4 TURBO S '19-21, XP 4 TURBO '16-21, XP 4 1000 '14-21, XP 1000 '14-21



CONVEX DESIGN DELIVERS
WIDE REAR VIEW

REARVIEW MIRROR TOP SELLER

- Works with all roofs, soft tops and windshields

» 2877945

TURBO S '18-21, XP TURBO '15-21, 4 TURBO S '19-21, XP 4 TURBO '16-21, XP 4 1000 '14-21, XP 1000 '14-21



SCRATCH-RESISTANT
GLASS MIRROR LENS

CONVEX REARVIEW MIRROR TOP SELLER

- Installs easily: mount bolts into your choice of pre-designated mounting locations on vehicle frame
- Convex design provides broad, expanded view of what's behind or alongside the vehicle

» 2881540

TURBO S '18-21, XP TURBO '15-21, 4 TURBO S '19-21, XP 4 TURBO '16-21, XP 4 1000 '14-21, XP 1000 '14-21



QUICK GLANCE,
WIDE-ANGLE VIEWING FOR
MAXIMUM VISIBILITY

WIDE-ANGLE REARVIEW MIRROR

- Stamped steel frame and backing plate with large 6.4 cm x 35.6 cm convex mirror
- Up to 10° of adjustability to adjust to rider height or view preference
- Easy over-structure installation with stamped steel mounts

» 2881199

TURBO S '18-21, XP TURBO '15-21, 4 TURBO S '19-21, XP 4 TURBO '16-21, XP 4 1000 '14-21, XP 1000 '14-21

TURBO S & XP

POLARIS RZR[®] RS1™

ALUMINUM ROOF

- Strong, durable 5051 aluminum construction
- 360-degree sealed to eliminate vibration

» 2882698-458 • BLACK
RZR RS1 '18-21

RZR RS1 SUBZERO 4-PT HARNESS

- Exclusive, controlled deceleration technology
- Better vehicle control, less ride fatigue and reduced submarining
- CAPE and Polaris validated

» 2882709
RZR RS1 '18-21

EXTREME DUTY BUMPER

- Front bumper required for winch installation
- Easy installation into factory mounts
- Fully e-coated and powder-coated for premium protection
- Includes all mounting hardware

» 2883783-458 • FRONT • BLACK
» 2882694-458 • REAR • BLACK
RZR RS1 '18-21

SPORT SIDE TIRE CARRIER

- Mounts directly to your Extreme Kick-Out Rock Sliders (2882695-458)

» 2882738
RZR RS1 '18-21

EXTREME KICK-OUT ROCK SLIDERS - STEEL

- Fully e-coated and powder-coated for premium protection
- Stock ground clearance is maintained
- Required for the Sport Side Tire Carrier (2882738)

» 2882695-458 • BLACK
RZR RS1 '18-21

SEE P. 48
FOR LIGHTING
& HARNESSES

LOCK & RIDE

LOCK & RIDE FULL WINDSHIELD - HARD COAT POLY

- Frameless design fully seals around cab frame
- Premium, optical-grade impact-resistant poly material

» 2882703
RZR RS1 '18-21

LOCK & RIDE

LOCK & RIDE HALF WINDSHIELD - POLY (NOT SHOWN)

» 2882704
RZR RS1 '18-21

POLARIS PRO HD 2,041 kg WINCH

» 2883825
RZR RS1 '18-21

See P. 76 for full winch details

SEE P. 68 FOR
PRO ARMOR
WHEEL & TIRE SETS

POLARIS ENGINEERED ADVANTAGES



PLUG & PLAY ELECTRICAL

EFFORTLESSLY ADD LIGHTS

POLARIS PULSE LIGHT BAR HARNESS
2883388

SEE P. 48 FOR
MORE INFORMATION



LOCK & RIDE

REVOLUTIONARY INSTALLATION

Lock & Ride clamps for easy on-off and eliminates the risk of cracking.



49L
1 helmet
2 goggles/gloves
12 beverage cans

LOCK & RIDE

49L COOLER/STORAGE COMBO - REAR

- Seamless mounting to the rear cargo platform

» 2882701
RZR RS1 '18-21



13L
10 beverage cans

13L COOLER/STORAGE COMBO - UNDERHOOD

- Fits in underhood compartment
- Removable, waterproof cooler liner for easy cleaning

» 2882700
RZR RS1 '18-21



10L
1 goggle
2 cell phones
3 small items

QUIKREACH 10L DOORPAK

- Three storage compartments
- "Quick to Reach" mounted directly to driver-side door

» 2882697
RZR RS1 '18-21



8L
2 cell phones
2 gloves
1 small item

QUIKREACH 8L DASHPAKS

- "Quick to Reach" storage on both sides of steering wheel

» 2883332
RZR RS1 '18-21



ADD A REAR PANEL TO REDUCE THE DUST SWIRL

With a windshield and roof installed, turbulent air develops behind the cab. Add a rear panel to reduce dust intrusion from this swirl.



SPORT LOW PROFILE BUMPER - FRONT

- Tough, tubular steel design
- Easy installation into factory mounts
- Fully e-coated and powder-coated for premium protection
- Includes all mounting hardware

» 2882692-458
RZR RS1 '18-21



BLUETOOTH INTEGRATED 200 WATT AUDIO SYSTEM BY MB QUART

- 2 x 13.3 cm speakers and 1.9 cm titanium dome tweeters with dash enclosures
- Fully-integrated Bluetooth Audio System
- Bluetooth remote fits seamlessly into switch panel
- Includes all necessary wiring, harnesses and mounting hardware

» 2882696
RZR RS1 '18-21



FULL COVERAGE FENDER FLARES

- Extra-wide design protects you and your vehicle from kicked-up debris
- Easily and seamlessly attaches to existing plastic
- Front & rear included

» 2883488
RZR RS1 '18-21



LOCK & RIDE

REAR PANEL - POLY

» 2882706
RZR RS1 '18-21

TRAILERABLE COVER NOT SHOWN

- Strong, durable, weatherproof canvas construction
- UV-stable to resist fading from prolonged exposure to sunlight

» 2882705
RZR RS1 '18-21

TURBO S & XP

WINDSHIELDS & REAR PANELS

ROOFS & DOORS

VEHICLE PROTECTION SWITCHES

STORAGE & MIRRORS

RZR RS1

TRAIL



RZR S 900

ALUMINUM ROOF	P. 38
LOWER DOOR INSERTS	P. 39
FRONT & REAR LOW PROFILE BUMPER - BLACK	P. 40
INTRUSION BAR	P. 71
PRO ARMOR 25.4 cm LIGHT BAR	P. 48
PRO ARMOR WHEELS & TIRES	P. 54
POLARIS PRO HD 1,588 kg WINCH	P. 76

RZR S 1000



POLARIS RZR

MAKE IT YOURS

Whatever your style, however you ride Polaris Engineered Accessories help you create your one-of-a-kind RZR.

ESSENTIALS TO KEEP YOU RIDING LONGER

- Roofs P. 38
- Windshields P. 36
- Rear Panels P. 37
- Doors P. 39
- Protection P. 40

ADD STYLE. ADD FUNCTION. ADD YOU.

- Audio P. 52
- Lighting P. 44
- Wheels & Tires P. 54
- Winches P. 76
- Storage P. 42
- Mirrors P. 75

THE RIGHT STUFF TO MAINTAIN YOUR RZR

- Maintenance P. 80
- Oil & Lubricants P. 82

EVERYTHING YOU NEED TO GEAR UP

- Riding Gear P. 90
- Casualwear P. 96

POLY SPORT ROOF - BLACK	P.38
LOCK & RIDE HALF WINDSHIELD - HARD COAT POLY	P.36
FRONT & REAR LOW PROFILE BUMPERS	P.40
PRO ARMOR 76.2 cm SINGLE-ROW COMBO LIGHT BAR	P.49
PRO ARMOR WHEELS & TIRES	P.54



> WINDSHIELDS

HARD COAT POLY



FLIP-DOWN WINDSHIELD - HARD COAT POLY

- Two-position design can be adjusted quickly without the use of tools
- Tough polycarbonate with scratch-resistant hard coat

▶ 2881616

S 900 '15-20, S 4 1000 '19-20, S 1000 '16-20, 900 '14-20
NOT COMPATIBLE WITH CANVAS ROOF (2880561)

LOCK & RIDE

VENTED WINDSHIELD - HARD COAT POLY

- Impact-resistant polycarbonate
- New vents allow for temperature regulation

▶ 2883111

S 900 '15-20, S 4 1000 '19-20, S 1000 '16-20, 900 '15-20

LOCK & RIDE

FULL WINDSHIELD - HARD COAT POLY TOP SELLER

- Durable, optical-grade polycarbonate for maximum impact resistance

▶ 2883110

S 900 '15-20, S 4 1000 '19-20, S 1000 '16-20, 900 '15-20

LOCK & RIDE

HALF WINDSHIELD - HARD COAT POLY TOP SELLER

- Strong, durable, impact-resistant polycarbonate

- Fully-sealed lower section of windshield to hood

▶ 2883109

S 900 '15-20, S 4 1000 '19-20, S 1000 '16-20, 900 '15-20

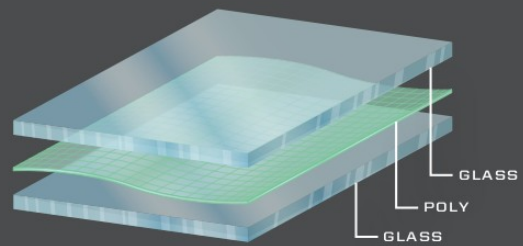
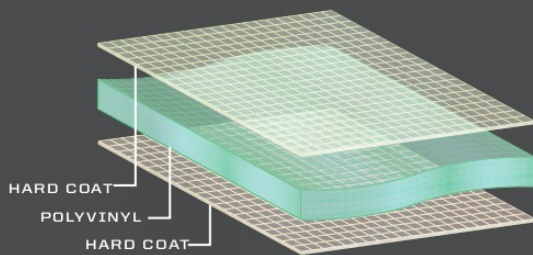

HARD COAT POLY VS GLASS

- Lightweight, flexible, easy to store/remove
- Impact-resistant
- Tight seal keeps out rain and dust
- Hard Coat: 30x more scratch resistance than regular poly windshields

- Superior optical clarity (automotive level)
- Scratch resistant
- Seals tight
- Cold weather / Heavy duty
- Wiper ready (windshield only)

POLARIS ENGINEERED ADVANTAGES



LOCK & RIDE

REVOLUTIONARY INSTALLATION

Lock & Ride clamps for easy on-off and eliminates the risk of cracking.



GASKET SEAL

Keep drafts and moisture out. Reduces ride chatter. Full airtight seal on glass windshields.

UPGRADE YOUR GLASS WINDSHIELD



WINDSHIELD WIPER SYSTEM

» 2879526
S 900 '15-20, S 4 1000 '19-20, S 1000 '16-20, 900 '14-20
ONLY COMPATIBLE WITH GLASS WINDSHIELD 2879447

GLASS



VENTED WINDSHIELD - GLASS

• 7.6 cm vent opens and closes with one-handed operation, providing immediate vent-out and increased cabin airflow

» 2883112
S 900 '15-20, S 4 1000 '19-20, S 1000 '16-20, 900 '15-20
NOT COMPATIBLE WITH WINDSHIELD WIPER SYSTEM (2879526)

GLASS WINDSHIELD

• Installs in minutes and integrates into a designated mounting position
• Laminated safety glass for excellent scratch resistance

» 2879447
S 900 '15-20, S 4 1000 '19-20, S 1000 '16-20, 900 '14-20



TRAIL ACCESSORIES

WINDSHIELDS & REAR PANELS

ROOFS & DOORS

RAMPERS & ROCK SLIDERS

STORAGE WINCHES, PLOWES & TRACKS

ADD A REAR PANEL TO REDUCE THE DUST SWIRL



> REAR PANELS



LOCK & RIDE REAR PANEL - POLY

» 2881613
S 900 '15-20, S 4 1000 '19-20, S 1000 '16-20, 900 '14-20
NOT COMPATIBLE WITH EXTREME AUDIO PODS (2883739)



REAR PANEL - CANVAS

• 652 g polyester canvas is mold-resistant for long-term performance and UV-stable to resist fading

» 2880608
S 900 '15-20, S 4 1000 '19-20, S 1000 '16-20, 900 '14-20
NOT COMPATIBLE WITH EXTREME AUDIO PODS (2883739)



REAR PANEL - MESH

» 2880409
S 900 '15-20, S 4 1000 '19-20, S 1000 '16-20, 900 '14-20



REAR RACE NET

» 2880408
S 900 '15-20, S 4 1000 '19-20, S 1000 '16-20, 900 '14-20

> ROOFS



POLY

LOCK & RIDE

POLY SPORT ROOF TOP SELLER

- Rigid injection-molded design to eliminate warping in high-heat conditions
- Integrated mounting locations for lighting
- Rugged, textured polyethylene construction for impact and abrasion resistance
- Not compatible with Canvas Upper Doors

COLOR	2-SEAT	4-SEAT <small>(NOT SHOWN)</small>
■ BLACK	2883073	2883074
	5 900 *15-20, 5 1000 *16-20, 900 *15-20	5 4 1000 *19-20

GRAPHIC SPORT ROOF

- Weighs only 5 kg (30% lighter than aluminum)
- Won't bend or break upon impact with debris or other obstacles
- Sunroof lets in sunlight while keeping you shaded from the heat

COLOR	2-SEAT	4-SEAT <small>(NOT SHOWN)</small>
■ BLACK	2881206	2881935
■ INDY RED	2881607	2881936
■ BRIGHT WHITE	2881608	2881937
	5 900 *15-20, 5 1000 *16-20, 900 *14-20	5 4 1000 *19-20

ALUMINUM VS POLY

- High protection strength
- Lower profile
- Sleek style

- Water run-off channels
- Quick on/off install
- Lightweight



ALUMINUM

ALUMINUM ROOF TOP SELLER

- Seals to the vehicle frame for the best protection and great integration with other RZR accessories
- Strong and durable 6061 aluminum construction for long-lasting, reliable protection

COLOR	2-SEAT	4-SEAT <small>(NOT SHOWN)</small>
■ BLACK	2881582-458	2881592-458
■ INDY RED	2881582-293	2881592-293
	5 900 *15-20, 5 1000 *16-20, 900 *14-20	5 4 1000 *19-20

CANVAS

CANVAS ROOF (NOT SHOWN)

- Durable, heavyweight 652 g polyester canvas construction
- Mold-resistant and UV-stable to resist fading for long-lasting performance
- Installs quickly and easily with provided straps

COLOR	2-SEAT	4-SEAT
■ BLACK	2880561	2880610
	5 900 *15-20, 5 1000 *16-20, 900 *14-20	5 4 1000 *19-20



> DOORS

ALUMINUM DOORS

- Single-piece stamped aluminum maximizes quality, fit and finish
- More cockpit room with wide berth
- Gasket design eliminates rattling and creates a firm seal
- Available with RZR-matched graphics

- » 2-SEAT • 2879510 SHOW
S 900 '15-20, S 1000 '16-20, 900 '15-20
- » 4-SEAT • 2879943
S 4 1000 '19-20



LOWER DOOR INSERTS TOP SELLER

- Covers the bottom of the door opening, shutting out water and dust
- Durable plastic construction with steel frame
- Includes optional rear bolster panels, not compatible on some models

- » 2-SEAT • 2879509
S 900 '15-20, S 1000 '16-20
- » 2-SEAT • 2880207
900 '14-20
- » 4-SEAT • 2879942
S 4 1000 '19-20



CANVAS UPPER DOORS

- Compatible with aluminum doors and roof
- Not compatible with Poly Sport Roof or Audio Roof options

- » 2-SEAT • 2879902
S 900 '15-20, S 1000 '16-20
- » 2-SEAT • 2880609
900 '14-20
- » 4-SEAT • 2879946
S 4 1000 '19-20

TRAIL



> BUMPERS

BULL BUMPERS

- Perfect for: Ultra light weight and minimalist look



3.8 cm x 5.1 cm
STEEL TUBE CONSTRUCTION

COLOR	FRONT	REAR
BLACK	2881202-458	2881472-458
INDY RED	2881202-293	2881472-293

S 900 '15-20, S 4 1000 '19-20, S 1000 '16-20, 900 '14-20
REAR BUMPERS NOT COMPATIBLE WITH STOCK S 4 1000 BUMPER

LOW PROFILE BUMPERS

- Perfect for: More protection, mounting accessories



4.4 cm DIAMETER
STEEL TUBE CONSTRUCTION

COLOR	FRONT
BLACK	2879449-458
INDY RED	2881583-293

S 900 '15-20, S 4 1000 '19-20, S 1000 '16-20, 900 '14-20

EXTREME BUMPER ATTACHMENT

- Perfect for: Increased protection around lighting and fenders



4.4 cm DIAMETER
STEEL TUBE CONSTRUCTION

COLOR	FRONT
BLACK	2879451-458
INDY RED	2881584-293

S 900 '15-20, S 4 1000 '19-20, S 1000 '16-20, 900 '14-20
REQUIRES LOW PROFILE FRONT BUMPER (2879449-XXX, 2881583-XXX)

ANCHOR MOUNTS

Tougher than conventional nuts and bolts, Expansion Anchor Mounts are engineered into every RZR, allowing for a fast install.

BUMPER ANCHOR PACK

- 4 Anchors and 2 Bumper End Caps included
- 2205114



> ROCK SLIDERS

LOW PROFILE ROCK SLIDERS - STEEL

- Plated steel construction, durable powdercoat finish
- Easy installation with expanded anchor mount

LOW PROFILE:
NO LOSS IN GROUND CLEARANCE

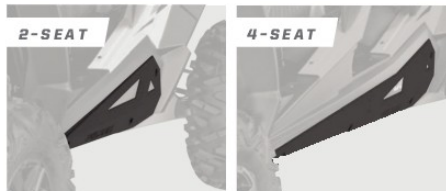

COLOR	2-SEAT	4-SEAT
BLACK	2879498-458	2879940-458
INDY RED	2881587-293	2881593-293
SKY BLUE	2881587-737	2881593-737

2-SEAT: S 900 '15-20, S 1000 '16-20, 900 '14-20
4-SEAT: S 4 1000 '19-20



DELUXE BUMPERS

- Perfect for: Maximum protection, integrated mounting points

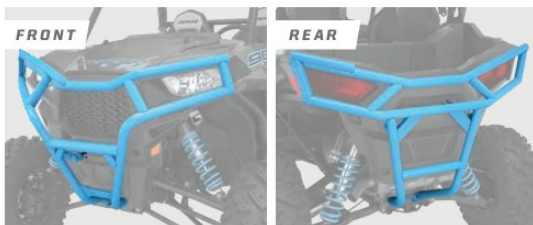

3.8 cm DIAMETER
STEEL TUBE CONSTRUCTION

COLOR	FRONT	REAR
BLACK	2880166-458	2880164-458
INDY RED	2881591-293	2881590-293
SKY BLUE	2881591-737	2881590-737

S 900 '15-20, S 4 1000 '19-20, S 1000 '16-20, 900 '14-20
REAR BUMPERS NOT COMPATIBLE WITH STOCK S 4 1000 BUMPER

EXTREME DUTY BUMPER

- Perfect for: Full protection in tough terrain and conditions



4.4 cm DIAMETER
STEEL TUBE CONSTRUCTION

WINCH INSTALLS
DIRECTLY TO BUMPER

COLOR	FRONT
BLACK	2880479-458

S 900 '15-20, S 4 1000 '19-20, S 1000 '16-20, 900 '14-20
DOES NOT FIT WITH ANY PLOW SYSTEM

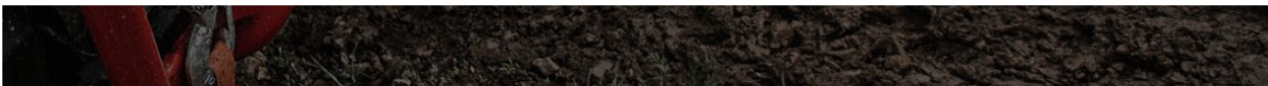

EXTREME KICK-OUT ROCK SLIDERS - STEEL

- Rugged steel protection and race-inspired styling
- Low-profile mounting location will not diminish ground clearance

4.4 cm DIAMETER
STEEL TUBE CONSTRUCTION



COLOR	2-SEAT	4-SEAT
BLACK	2879456-458	2882079-458
INDY RED	2881586-293	2882079-293
SKY BLUE	2881586-737	2882079-737

2-SEAT: S 900 '15-20, S 1000 '16-20, 900 '14-20
4-SEAT: S 4 1000 '19-20

TRAIL

> STORAGE



SEE P. 75 FOR MIRRORS

LOCK & RIDE

COOLER BOX

- One-piece rotomolded construction for extreme durability
- Lid locks securely in place with rubber latches to protect cargo
- Heavy-duty hinges and weatherproof seal block moisture and dust
- Keeps food and beverages cool for 48+ hours, depending on conditions
- UV-fade resistant
- Installs quickly and easily without tools
- Easy to carry with integrated grab handles

▶ 48 L • 2881556

S 900 '15-20, S 4 1000 '19-20, S 1000 '16-20, 900 '14-20
NOT COMPATIBLE WITH SPARE TIRE CARRIER (2880148)



BED D-RINGS

▶ 2877460

S 900 '15-20, S 4 1000 '19-20, S 1000 '16-20, 900 '14-20

LOCK & RIDE D-RINGS

▶ 2881544

LOCK & RIDE QUICKSTRAP

- Quickest, most secure way to mount Polaris accessories

▶ 2882187



LOCK & RIDE

CARGO BOX

TOP SELLER

- Integrated rear cargo box touting 65 liters of storage
- Secure latching lid with taut rubber strap tie-downs
- Lightweight design integrates seamlessly with RZR Rear Cargo Bed
- Includes all mounting hardware for complete installation

▶ 2881193

S 900 '15-20, S 4 1000 '19-20, S 1000 '16-20, 900 '14-20



UNDER-HOOD STORAGE BIN

TOP SELLER

- Perfect out of the way space for a tool kit, extra belt, tow straps, corner knock-outs for bungee cords (not included) secures your cargo

▶ 2882080

S 900 '15-20, S 4 1000 '19-20, S 1000 '16-20, 900 '14-20



OVERHEAD BAG

▶ 2879516

S 900 '15-20, S 4 1000 '19-20, S 1000 '16-20, 900 '14-20



UPPER DOOR STORAGE BAG

▶ 2880612

S 900 '15-20, S 4 1000 '19-20, S 1000 '16-20
ONLY COMPATIBLE WITH FRONT DOORS OF ALL MODELS



LOWER DOOR STORAGE BAG

▶ 152 cm • 2880613

S 900 '15-20, S 4 1000 '19-20, S 1000 '16-20
REQUIRES LOWER DOOR 2879509 OR 2879942
ONLY COMPATIBLE WITH FRONT DOORS OF ALL MODELS



SPARE TIRE CARRIER

▶ 2880148

S 900 '15-20, S 4 1000 '19-20, S 1000 '16-20, 900 '14-20
REQUIRES REAR CAB FRAME EXTENSION (P. 71)

> WINCHES

FEATURES	PRO PRO HEAVY DUTY SERIES	HD HEAVY DUTY SERIES	
RAPID ROPE RECOVERY	STANDARD	NOT AVAILABLE	
AUTO STOP TECHNOLOGY	STANDARD	OPTION	
WINCH LINE	SYNTHETIC ROPE	STEEL CABLE	
FAIRLEAD	ALUMINUM	STEEL ROLLER	
CONTROL	WIRELESS STANDARD, WIRED OPTION	WIRED STANDARD, WIRELESS OPTION	
MODEL	2,041 kg S 900 '15-21, 900 '14-21 S 4 1000 '19-20, S 1000 '16-21	1,588 kg S 900 '15-21, 900 '14-21 S 4 1000 '19-20, S 1000 '16-21	ADD REQUIRED CABLES SEE P. 49 FOR BUSBAR HARNESS FITMENT

REPLACEMENT PARTS

SYNTHETIC ROPE

2,041 kg SERIES - 50 ft.
▶ 2879187



STEEL CABLE

1,588 kg SERIES - 50 ft.
▶ 2878890
WORKS WITH 2881671



UPGRADE YOUR CONTROLS

WIRED REMOTE CONTROL

- Must order remote handle and socket together

▶ REMOTE HANDLE 4013466
▶ SOCKET 4014228
WORKS WITH 2882240 WORKS WITH 2882240

UPGRADE YOUR HD WINCH

WIRELESS REMOTE

- Up to 15 m range with LED indicator
 - Direct plug and play operation
- ▶ 2879316



AUTO STOP UPGRADE

- Billeted aluminum
 - Replaces stock fairlead
- ▶ 2881693
SYNTHETIC ROPE REQUIRED

GLACIER[®] HD PLOW SYSTEM

MAKE QUICK WORK OF SMALLER JOBS

Move snow with the robust and capable Glacier HD plow system, and discover why a major snowfall can be the highlight of your week. With a robust frame, beefy poly and steel blade options, dismantling and amazing value, Glacier HD is a great choice in the dead of winter.



GLACIER HD GIVES YOU

- » 168 cm Blades
- » Choice of poly or steel
- » Manual angle system standard

LOCK & RIDE

43 cm

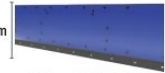

168 cm POLY BLADE
BEST FOR CORROSION RESISTANCE

43 cm



168 cm STEEL BLADE
BEST FOR BIG JOBS YEAR AFTER YEAR

CREATE YOUR GLACIER HD PLOW SYSTEM IN 5 STEPS

	STEP 1 SELECT A MOUNT	STEP 2 SELECT A FRAME	STEP 3 SELECT A LIFT METHOD	STEP 4 SELECT A BLADE	STEP 5 SELECT ACCESSORIES
MODELS	MOUNT	FRAME	WINCH	BLADES	ACCESSORIES
\$ 900 '15-20 \$ 4 1000 '19-20 \$ 1000 '16-20 900 '14-20	GLACIER Pro Plow Mount 2880262	GLACIER Pro HD Plow Frame 2880260	Polaris PRO HD 2,041 kg Winch See P. 76 for details Polaris HD 1,588 kg Winch See P. 76 for details	GLACIER Pro Plow 168 cm Poly 2880269 GLACIER Pro Plow 168 cm Steel 2880268	168 cm Snow Deflector 2879866 168 cm HD Wear Bar 2879868 168 cm Wear Bar 2879867 Plow Marker 2872726 Skid Shoe 2208864 Shear Pin 2205527 Extension for Tracks 2880267

GET READY FOR WINTER



HEATER KIT

- » 2881552
- S 900 '15-20, S 4 1000 '19-20, S 1000 '16-20, 900 '14-20



PRO ARMOR WHITEOUT

- » 5416395

SEE P. 65 FOR ALL TIRE SPECS

Polaris-specific gearing provides 1:1 ratio to: Minimize track slip, providing better climbing ability and improved traction in deep snow
 Improve top speed over prior models by approximately 5%
 Reduce operating RPM for a quieter ride
 Improve driveline durability, which allows vehicle to run at a lower RPM, decreasing engine wear

New front dual stabilizer for improved stability

Polaris exclusive optimized hub geometry that minimizes feedback and eases steering effort

Lightweight design provides for better flotation, eases steering effort, and provides better vehicle control

Flexible lug design provides the highest level of deep snow performance by lifting up in deep snow as opposed to digging down



NON EPS MODEL

- » 2880757
20 FRONT, 18 REAR
FOR USE ON THE FOLLOWING MODELS NOT EQUIPPED WITH FACTORY EPS: S 900 '15-20, S 4 1000 '20, S 1000 '19-20, 900 '15-20
- » MOUNTS • 2880648
900 '14-20
MOUNTS FIT 50" WIDE RZR MODELS

EPS MODEL

- » 2880758
18 FRONT, 18 REAR
FOR USE ON THE FOLLOWING MODELS THAT COME WITH FACTORY-INSTALLED EPS: S 900 '15-20, S 4 1000 '19-20, S 1000 '16-20, 900 '15-20
- » MOUNTS • 2880649
FITS THE FOLLOWING 60" WIDE RZR MODELS: S 900 '15-20, S 4 1000 '19-20, S 1000 '16-20, 900 '15-20

PLOW EXTENSION 2880267 REQUIRED FOR USING A PLOW WITH TRACKS
 ONLY COMPATIBLE WITH GLACIER PRO HD SYSTEM

TRAIL ACCESSORIES

WINDSHIELDS
6 REAR PANELS

ROOFS & DOORS

RUMPERSS
ROCK SLIDERS

STORAGE WINCHES
PLOW & TRACKS

FROM DUSK

Extend your ride time and be more visible to others with the brightest light bars in the industry.

RIGID LIGHT BARS P.48

A trusted name in the off-road lighting industry, RIGID delivers unmatched technology and superior performance.



POLARIS HEADLIGHTS AND ACCENTS

Replace your stock headlights, add more lumens to the trail, and keep the ride going into the night.

TRAILBLAZER LED ADJUSTABLE HEADLIGHTS

- Direct replacement for factory headlight
- 6,000 lumen total output; 20-watt CREE XHP LED Chips
- Durable construction is waterproof, dustproof, and fade resistant
- Integrated LED daytime running light
- Includes six black bezels

2882073

TURBO S '18-21, XP TURBO '19-21, 4 TURBO S '20-21, XP 4 TURBO '19-21, XP 4 1000 '14-21, XP 1000 '14-21, S 900 '15-20, S 4 1000 '19-20, S 1000 '16-20, R51 '18-21, PRO XP '21, 900 '14-20

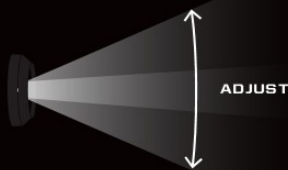

CONTROL BEAM PATTERNS

The Trailblazer LED headlight features adjustable beams on the inside and outside reflectors. Set the beam to your desired width or focus to dial in your beam pattern.

MIX & MATCH COLOR BEZELS

- Personalize the look of your Trailblazer lights with interchangeable color-matched bezels
- Choose from a variety of colors, or mix and match



COLOR 2-PACK

WHITE	2882479-133
RED	2882479-293
BLUE	2882479-689
RAW	2882479

TURBO S '18-21, XP TURBO '15-21, 4 TURBO S '19-21, XP 4 TURBO '16-21, XP 4 1000 '14-21, XP 1000 '14-21, S 900 '15-20, S 4 1000 '19-20, S 1000 '16-20, R51 '18-21

'TIL DAWN

PRO ARMOR LIGHT BARS P.49

Pro Armor gives you aggressive styling, rugged protection, and lighting solutions for your riding needs.



SHOWCASE YOUR STYLE

Be a shining beacon of color when you ride at night. With our colorful line of LED accent lights and headlight bezels, you can stand out from the rest of the pack and create an iconic ride.

TOP SELLER FANG ACCENT LIGHT KIT

- Includes a pair of front fascia accent lights and a rear, center taillight
- Durable dust and waterproof construction

» FRONT/REAR • 2884053
TURBO S '19-21, XP TURBO '19-21, 4 TURBO S '19-21, XP 4 TURBO '19-21, XP 4 1000 '19-21, XP 1000 '19-21



ACCENT LIGHTS

- Four LEDs and all harnessing/switching required. Single lights can be added to the kit (kit required)
- Durable dust and waterproof construction
- Control hub and complete instructions included



COLOR	LIGHTING KIT (Comes in set of 4)
RED	2880500
BLUE	2880506

TURBO S '18-21, XP TURBO '15-21, 4 TURBO S '19-21, XP 4 TURBO '15-21, XP 4 1000 '14-21, XP 1000 '14-21, S 900 '15-20, S 4 1000 '19-20, S 1000 '16-20, 900 '14-20

SEE P. 49 TO ADD HARNESSES

COMMON

LIGHTING

RISE COMMAND
& AUDIO

WHEELS & TIRES

VEHICLE & RIDER
PROTECTION

COOLERS

COCKPIT
ACCESSORIES

WINDSHIELDS

MISC & YOUTH

BUILD YOUR

OPTICS

ACCENT

USAGE

DIFFUSED COLORED LIGHT ADDED FOR STYLE & PERSONALIZATION

- Durable, dust and water resistant construction
- Ideal for: Showcasing your lifted vehicle or custom suspension



DRIVING SPEED

ALL

DRIVING

GREAT FOR ALL RIDING STYLES, TERRAINS OR WORK APPLICATIONS

- Beam: Extra-wide, moderate center intensity
- Recommended Mounting: All points



SLOW TO MEDIUM

FLOOD

BEST FOR WIDE-OPEN TERRAINS OR WORK APPLICATIONS REQUIRING BROAD LIGHT

- Beam: Wide, shorter
- Ideal for: Medium speeds when peripheral vision is important
- Recommended Mounting: Low & rear



SLOW TO MEDIUM

LIGHT ANGLE

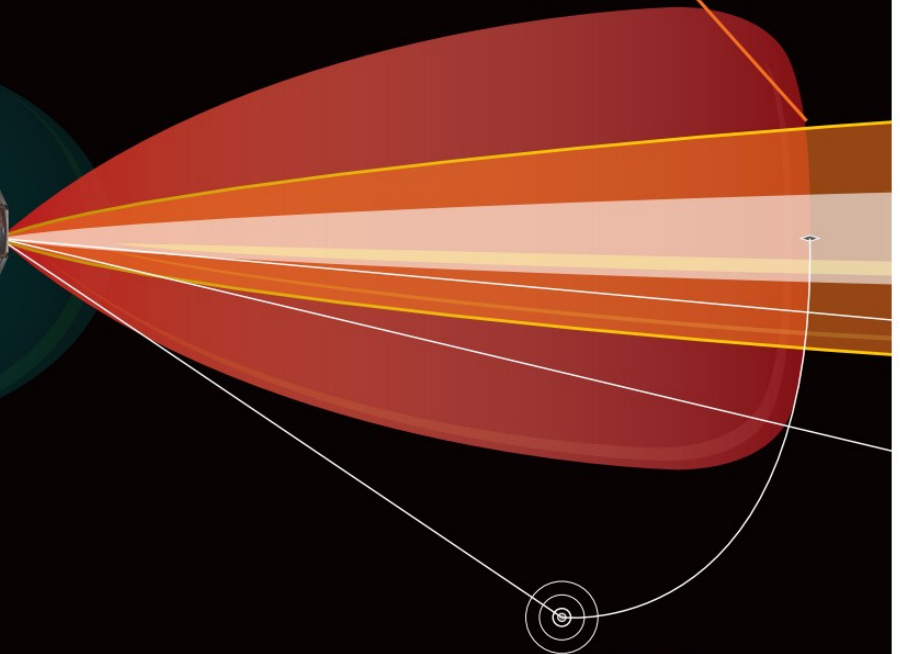
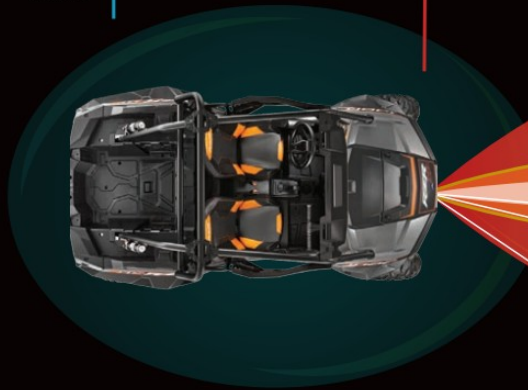

DRIVING
(45°)

VISION

SPOT

BEST FOR TIGHT RIDING TERRAINS AND CONDITIONS REQUIRING LONG-DISTANCE VISIBILITY

- Beam: Concentrated long beam
- Ideal for: High speeds to see & react to your environment
- Recommended Mounting: High



COMBO

ALL-AROUND VERSATILITY FOR ANY RIDING TERRAIN, CONDITION OR WORK APPLICATION

- Beam: Combination of flood and spot optics
- Ideal for: All-around distance visibility
- Recommended Mounting: All points



HIGH

COMBO
FLOOD & SPOT
(25"/10")

SPOT
(10")

FLOOD
(25")

COMMON

LIGHTING

RISE COMMAND
& AUDIO

WHEELS & TIRES

VEHICLE & RIDER
PROTECTION

COOLERS

COCKPIT
ACCESSORIES

WINDSHIELDS

MISC. & YOUTH

RIGID

POLARIS ENGINEERED
ADVANTAGES

MOUNTS PERFECTLY
Designed for your Polaris Engineered bumper, roof or other mounting point

ADVANCED TECH

RIGID lights are driven by Aluminum PCB Smart Boards, 6063-T5 aircraft aluminum extruded housings and Tiger Drylac UV protection polyester powdercoating.

EXCLUSIVE OPTICS

RIGID invests heavily in optical science and has patented multiple optics and optics systems, maximizing light output and efficiency.

LIGHT BAR TYPES



SR-SERIES PRO

Sleek, powerful, low-profile (under 5 cm tall). Lights extreme distances with low energy usage. Available in 25.4 cm & 81.3 cm



D-SERIES PRO

Compact to fit almost anywhere with high output and low energy usage. Available in Driving, Flood & Spot

LIGHT BAR OPTIONS

OPTICS

DRIVING

FLOOD

SPOT

1200m
960m
720m
480m
240m

BRAND SIZE TYPE

RAW LUMENS

PN

RIGID
POD
D-SERIES

4,752

2883128

Comes in a pair

RIGID
25.4 cm
SR-SERIES

7,920

2883122

RIGID
POD
D-SERIES

3,168

2883126

Comes in a pair

PRO ARMOR
27.9 cm
SINGLE-ROW

1,890

2882313

PRO ARMOR
25.4 cm
DUAL-ROW

3,780

2882311

PRO ARMOR
CUBE
DUAL-ROW

1,400

2882312

RIGID
25.4 cm
SR-SERIES

7,920

2883121

RIGID
POD
D-SERIES

3,168

2883127

Comes in a pair

PRO ARMOR
27.9 cm
SINGLE-ROW

1,890

2882078

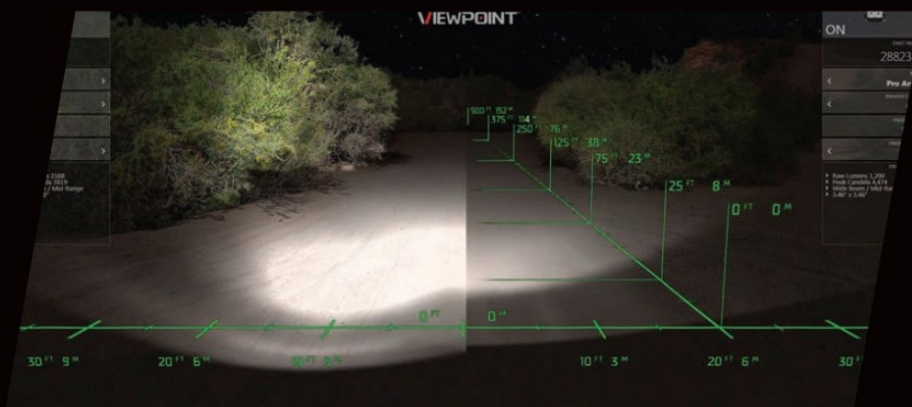

MAX PERFORMANCE
Validated to work as hard
as your machine does

DOESN'T OVERTAX
Trust it to work when
you need it to

PRO ARMOR

RUGGED CONSTRUCTION

Pro Armor lights are designed to be big and beefy with an aggressive style all their own, and housed in IP67 marine-grade rated UV polyester powdercoating.

MASSIVELY BRIGHT

Pro Armor builds bright lights designed for any riding experience. All that power is directed through heat dissipating aluminum for streamlined heat management.



DUAL-ROW LED LIGHT BARS

The most spread and farthest illumination downrange. Easy to mount.
Available in Cube, 25.4 cm, 50.8 cm & 76.2 cm



SINGLE-ROW LED LIGHT BARS

Powerful, compact, low-profile light bars with sleek look.
Available in 27.9 cm & 83.8 cm



CUBE LED LIGHTS

Small size allows mounting in strategic locations for added lighting.
Available in Flood & Spot

COMBO

OPTICS

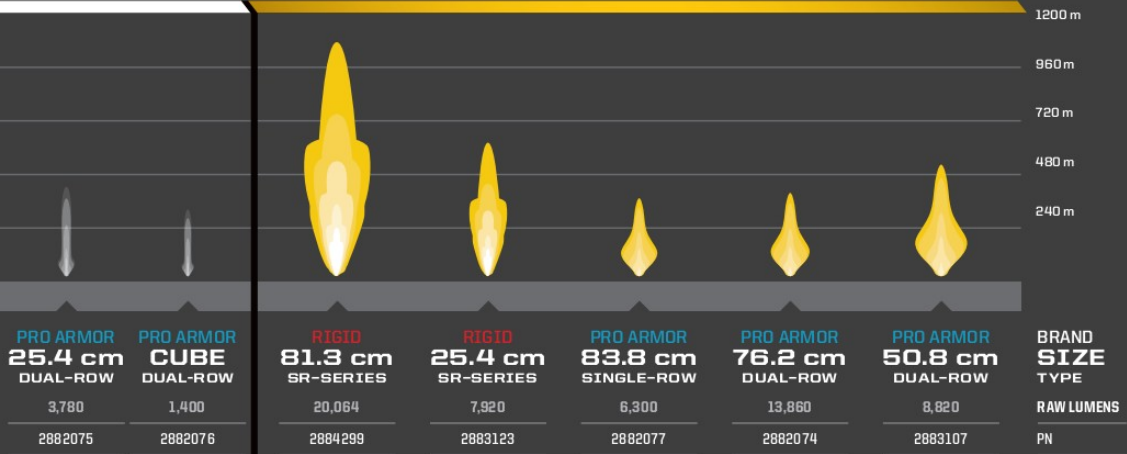

ADD A HARNESS TO MOUNT YOUR LIGHTS

MODEL	LIGHT BAR SET-UPS		
	1 LIGHT IN 1 LOCATION ON 1 SWITCH	2 LIGHTS IN 2 LOCATIONS ON 1 SWITCH	2 LIGHTS IN 2 LOCATIONS ON 2 SWITCHES
PRO XP 4 '20-21 PRO XP '20-21	POLARIS PULSE LIGHT BAR HARNESS 2883949 ADAPTER HARNESS 2412616	POLARIS PULSE LIGHT BAR HARNESS 2883949 ADAPTER HARNESS 2412616 Y-HARNESS 2879860	POLARIS PULSE LIGHT BAR HARNESS (x2) 2883949 ADAPTER HARNESS (x2) 2412616
RS1 '18-21	POLARIS PULSE LIGHT BAR HARNESS 2883388	POLARIS PULSE LIGHT BAR HARNESS 2883388 Y-HARNESS 2879860	POLARIS PULSE LIGHT BAR HARNESS (x2) 2883388
TURBO S '18-21, 4 TURBO S '19-21, XP TURBO '15-21, XP 4 TURBO '16-21, XP 1000 '14-21, XP 4 1000 '14-21, S 1000 '16-20, S 4 1000 '19-20, S 900 '15-20, 900 '14-20	LIGHT BAR HARNESS 2883486	LIGHT BAR HARNESS 2883486 Y-HARNESS 2879860	LIGHT BAR HARNESS (x2) 2883486

ADD BATTERY CONNECTION CABLES FOR POWER

BUSBAR HARNESSES	
MODEL	BUSBAR HARNESS
PRO XP/PRO XP 4 '20-21, RZR RS1 '18-21, XP TURBO/XP 4 TURBO '17-21, XP 1000/XP 4 1000 '18-21, TURBO S '18-21, 4 TURBO S '19-21	HARNESS NOT REQUIRED
S 900 '16-20 S 1000 '16-20 900 '15-20	2881551
S 4 1000 '19-20	2881646

 All RIGID and Pro Armor lights are Polaris PULSE ready.

SEE P. 15 FOR EXCLUSIVE PRO XP RIGID LIGHT BAR OPTIONS

COMMON

LIGHTING

RISE COMMAND & AUDIO

WHEELS & TIRES

VEHICLE & RIDER PROTECTION

COOLERS

COCKPIT ACCESSORIES

WINDSHIELDS

MISC & YOUTH

RIDECOMMAND

- BUILT-IN GPS WITH TOPOGRAPHY MAPS TO SEE YOUR LOCATION AND PLAN YOUR RIDE
- MEDIA PLAYER WITH BUILT IN AM/FM TUNER FOR ALL YOUR FAVORITE MUSIC
- GROUP RIDE FOR BUDDY TRACKING, TO SEE YOUR FRIENDS ON THE MAP, TRACK AND SHARE RIDE STATS ON THE DISPLAY OR RIDE COMMAND MOBILE APP

REVOLUTIONIZING THE OFF-ROAD EXPERIENCE

RIDE COMMAND 7" DISPLAY

- 7" high bright touchscreen visible in all conditions
- Displays critical vehicle information for fuel level, coolant temp and battery voltage
- Media player with built in AM/FM tuner*
- Buddy tracking and share your ride with the Ride Command mobile app
- Dedicated shortcut buttons for quick access to features
- Bluetooth and USB smart phone connectivity
- Front and rear camera support for better visibility on and off trail

2884072

TURBO S '19-21, XP TURBO '19-21, 4 TURBO S '19-21, XP 4 TURBO '19-21, XP 4 1000 '19-21, XP 1000 '19-21, PRO XP 4 '20-21, PRO XP '20-21

RIDE COMMAND MOUNT KIT

- Mount your 7" touchscreen to RZR
- Replaces dash for seamless fit and finish
- Includes front and rear cameras with mounts
- Comes with wiring harnesses needed for RZR and accessory components
- When adding audio to an XP, add required Ride Command Audio Adapter (2883232, P. 53)

2884073

PRO XP 4 '20-21, PRO XP '20-21
INCLUDES GROUP RIDE HARNESS KIT (2884449)

2884021

TURBO S '19-21, XP TURBO '19-21, 4 TURBO S '19-21, XP 4 TURBO '19-21, XP 4 1000 '19-21, XP 1000 '19-21
OPTIONAL ADD-ON: GROUP RIDE HARNESS KIT (2884449)

DOWNLOAD THE RIDE COMMAND MOBILE APP





COMMON

LIGHTING

RIDE COMMAND
& AUDIO

WHEELS & TIRES

VEHICLE & RIDER
PROTECTION

COOLERS

COCKPIT
ACCESSORIES

WINDSHIELDS

MISC & YOUTH

FRONT CAMERA KIT

- Front camera upgrade for increased visibility and safety
- Increases driver awareness of obstacles and terrain for enhanced riding
- All wiring harnesses included on vehicle

» 2884432

TURBO S '19-21, XP TURBO '19-21, 4 TURBO S '19-21,
XP 4 TURBO '19-21, XP 4 1000 '19-21, XP 1000 '19-21,
PRO XP 4 '20-21, PRO XP '20-21



GROUP RIDE HARNESS KIT

- Upgrade kit to enable Ride Command 7" Display with Group Ride functionality
- Includes antenna and all wiring harnesses for install

» 2884449

TURBO S '19-21, XP TURBO '19-21, 4 TURBO S '19-21,
XP 4 TURBO '19-21, XP 4 1000 '19-21, XP 1000 '19-21
STANDARD IN PRO XP / PRO XP 4 MOUNT KIT

SEE NEXT PAGE TO ADD AUDIO

OFF-ROAD GRADE AUDIO

BUILD YOUR AUDIO SYSTEM

MBQUART®

1 CHOOSE A HEAD UNIT Control all aspects of your sound system. Choose what to listen to and how loud.



RIDE COMMAND

SEE P. 50 FOR MORE INFO

- Total command center for a world of connection at your fingertips
- Media player with built in AM/FM tuner for all your favorite music*
- Built in GPS with topography maps to see your location and plan your ride
- Group Ride for buddy tracking, to see your friends on the map, track and share ride stats on the display or Ride Command mobile app

» 2884072

TURBO S '19-21, XP TURBO '19-21, 4 TURBO S '19-21, XP 4 TURBO '19-21, XP 4 1000 '19-21, XP 1000 '19-21
MOUNT REQUIRED. SEE P. 50



BASE UNIT OR ADD SPEAKERS

AUDIO ROOF

- All-in-one solution or use as base unit to build your system
- Four (4) high-efficiency 16.5 cm coaxial speakers for unbeatable sound
- Built in push-button dash radio with Bluetooth and AUX
- Modular design for improved serviceability and access

S4 AUDIO ROOF

» 2882064

XP TURBO '15-21, XP 1000 '14-21, S 900 '15-20, S 1000 '16-20, 900 '14-20

S8 AUDIO ROOF

» 2882065

XP TURBO '15-21, XP 1000 '14-21, S 900 '15-20, S 1000 '16-20, 900 '14-20

S10 AUDIO ROOF

» 2882066

XP TURBO '15-21, XP 1000 '14-21, S 900 '15-20, S 1000 '16-20, 900 '14-20

MODEL: S4 S8 S10

(4) 16.5 cm COAXIAL SPEAKERS	✘	✘	✘
(4) 16.5 cm COMPONENT SPEAKERS MIDS & TWEETERS		✘	✘
(2) 15.2 cm x 22.9 cm COAXIAL SPEAKERS			✘
4-CHANNEL 2-OHM 300W AMPLIFIER		✘	✘
83.8 cm SINGLE-ROW PRO ARMOR LIGHT BAR		✘	
76.2 cm DUAL-ROW PRO ARMOR LIGHT BAR			✘
DOME LIGHT	✘	✘	



DASH RADIO

- Seamless dash integration and convenient push-button design
- Bluetooth connectivity
- Remote-mounted USB / 3.5 mm plug for external device connection

» 2881988

XP 1000 '14-21, XP 4 1000 '14-21, XP TURBO '15-21, XP 4 TURBO '16-21, TURBO S '18-21, 4 TURBO S '19-21



Sound Bar 8



Sound Bar 4

SOUND BAR

NOT COMPATIBLE WITH ADDITIONAL/EXTERNAL SPEAKERS OR RIDE COMMAND

- All-in-one solutions for a quick and easy audio upgrade to your machine

SOUND BAR 8

- Six mid-range/mid-bass speakers and two dedicated tweeters
- Fully waterproof with large, easy-to-use external controls

» 2881465

XP TURBO '15-21, XP 1000 '14-21, XP 4 TURBO '16-21, XP 4 1000 '14-21, S 900 '15-20, S 4 1000 '19-20, S 1000 '16-20, 900 '14-20

SPEAKER BAR HARNESS (2882280) BUSBAR HARNESS REQUIRED. SEE RIGHT.

SOUND BAR 4

- Two mid-range/mid-bass speaker and two dedicated tweeters

» 2881230

XP TURBO '15-21, XP 1000 '14-21, XP 4 TURBO '16-21, XP 4 1000 '14-21, S 900 '15-20, S 4 1000 '19-20, S 1000 '16-20, 900 '14-20

SPEAKER BAR HARNESS (2882280) BUSBAR HARNESS REQUIRED. SEE RIGHT.

When you research audio solutions, you'll see manufacturers bragging about how their audio equipment is "Marine Grade". Or worse yet, you'll discover they are repackaged components built for automotive applications. MB Quart, combined with Polaris, engineers Off-Road Grade Audio equipment that's proven to deliver the loudest, crispest sound in the harshest conditions. Rain, snow, mud, heat, cold, dust—**ANY PLACE YOUR RZR EXCELS, SO WILL YOUR AUDIO.**

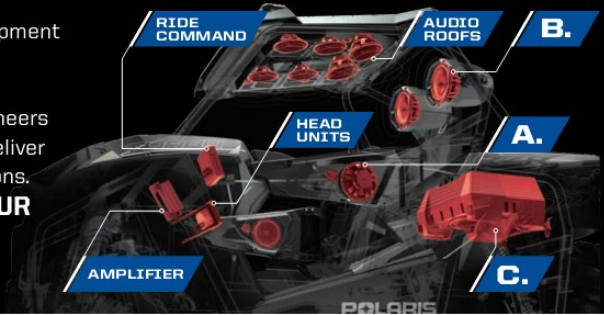

2 ADD SPEAKERS - MIX AND MATCH

Build your dream audio system. From a simple setup with only door speakers, to a complex system with door speakers, audio pods and a subwoofer—**BUILD IT YOUR WAY.**



A. DOOR SPEAKERS

- High performance 16.5 cm component speakers with 1.9 cm titanium dome tweeters
- Harnessing included to connect to audio amplifier
- Works with Polaris Aluminum Door kits or Polaris Lower Door kits
- Requires Dash Audio Amplifier (2883738 or 2884064, see bottom right for details & fitment)

▶ FRONT • 2881989 (Set of two)

TURBO S '18-21, XP TURBO '15-21, 4 TURBO S '19-21, XP 4 TURBO '15-21, XP 4 1000 '14-21, XP 1000 '14-21, S 900 '15-20, S4 1000 '19-20, S 1000 '16-20

NOT COMPATIBLE WITH DYNAMIX ACTIVE SUSPENSION MODELS

▶ REAR (4-SEAT ONLY) • 2883116 (Set of two)

4 TURBO S '19-21, XP 4 TURBO '16-20, XP 4 1000 '14-20, S4 1000 '19-20

REQUIRES FRONT DOOR SPEAKERS (2881989) CONNECTS DIRECTLY TO AUDIO AMPLIFIER (2884064). NO ADDITIONAL AMPLIFIER NEEDED. HARNESSING INCLUDED. NOT COMPATIBLE WITH AUDIO ROOFS.



B. EXTREME AUDIO PODS

- Two 20.3 cm coaxial speakers with 2.5 cm titanium tweeters in weatherproof enclosures
- Self-amplified 200-watt per speaker output
- Rear Audio Harness included

▶ 2883739

TURBO S '18-21, XP TURBO '15-21, 4 TURBO S '19-21, XP 4 TURBO '16-21, XP 4 1000 '14-21, XP 1000 '14-21, S 900 '15-20, S4 1000 '19-20, S 1000 '16-20, 900 '15-20



C. 30.5 cm MAXBOOST SUBWOOFER

- High strength molded enclosure for optimal acoustics and superior fit
- Lock & Ride connectivity to cargo bed
- Integrated 250-watt Class D amplifier
- Deep bass 30.5 cm subwoofer with 5.1 cm voice coil
- Wiring harness included

▶ 2882063

TURBO S '18-21, XP TURBO '15-21, 4 TURBO S '19-21, XP 4 TURBO '16-21, XP 4 1000 '14-21, XP 1000 '14-21, S 900 '15-20, S4 1000 '19-20, S 1000 '16-20, 900 '15-20

3 MAKE IT WORK

BUSBAR HARNESS

VEHICLE FITMENT	BUSBAR HARNESS
RZR RS1 '18-21, XP TURBO/XP 4 TURBO '17-21, XP 1000/XP 4 1000 '18-21, TURBO S '18-21, 4 TURBO S '19-21	HARNESS NOT REQUIRED
S 900 '16-20, 900 '15-20, S 1000 '16-20	2881551
S4 1000 '19-20	2881646

Y-AUDIO HARNESS

- Y-Harness splits the audio signal to allow for additional audio components to be added

▶ 2883269

TURBO S '18-21, XP TURBO '19-21, 4 TURBO S '20-21, XP 4 TURBO '19-21, XP 4 1000 '14-21, XP 1000 '14-21, S 900 '15-20, S4 1000 '19-20, S 1000 '16-20, 900 '14-20

LINE OUT AUDIO HARNESS

- Harness designed to extend JST audio signal. Use to run JST audio signal from rear of audio roof to the front of the vehicle

▶ 2881652

TURBO S '18-21, XP TURBO '19-21, 4 TURBO S '20-21, XP 4 TURBO '19-21, XP 4 1000 '14-21, XP 1000 '14-21, S 900 '15-20, S4 1000 '19-20, S 1000 '16-20, 900 '14-20

RIDE COMMAND ONLY

RIDE COMMAND AUDIO ADAPTER

- Required to hook up any audio Ride Command system
- Connect up to 2 speaker options and subwoofer
- Specifically designed for subwoofer

▶ 2883232

TURBO S '18-21, XP TURBO '19-21, 4 TURBO S '20-21, XP 4 TURBO '19-21, XP 4 1000 '14-21, XP 1000 '14-21, S 900 '15-20, S4 1000 '19-20, S 1000 '16-20, 900 '15-20

REQUIRED WHEN ADDING AUDIO TO RIDE COMMAND 7" DISPLAY (2884072) DOOR SPEAKERS AND AUDIO AMPLIFIER NOT RECOMMENDED WITH DYNAMIX ACTIVE SUSPENSION MODELS.

SOUND BARS ONLY

SPEAKER BAR HARNESS

- Used to connect sound bar to accessory busbar for power

▶ 2882280

TURBO S '18-21, XP TURBO '19-21, 4 TURBO S '20-21, XP 4 TURBO '19-21, XP 4 1000 '14-21, XP 1000 '14-21, S 900 '15-20, S4 1000 '19-20, S 1000 '16-20, 900 '14-20

BUSBAR HARNESS REQUIRED, SEE ABOVE.

DOOR SPEAKERS ONLY

DASH AUDIO AMPLIFIER

- This amplifier is a 200-watt TDA-based full-range Class D amplifier with fixed connections for power, ground and turn-on and Delphi connectors for door speakers

- Required with Door Speakers (2-Seat: 2881989 and 4-Seat: 2883116)

▶ 2883738

S 900 '15-20, S4 1000 '19-20, S 1000 '16-20, 900 '15-20

▶ 2884064

TURBO S '19-21, XP TURBO '19-21, 4 TURBO S '20-21, XP 4 TURBO '19-21, XP 4 1000 '19-21, XP 1000 '19-21

COMMON

LIGHTING

RIDE COMMAND & AUDIO

WHEELS & TIRES

VEHICLE & RIDER PROTECTION

COOLERS

COCKPIT ACCESSORIES

WINDSHIELDS

MISC & YOUTH



PRO ARMOR[®] TIRES





DOMINATE ANY ENVIRONMENT

FIND THE RIGHT PRO ARMOR TIRE FOR YOUR RZR

Developed and tested with Polaris engineers, ensuring the perfect fit and optimal performance mile after mile.



COMMON

LIGHTING

RISE COMMAND
& AUDIO

WHEELS & TIRES

VEHICLE & RIDER
PROTECTION

COOLERS

COCKPIT
ACCESSORIES

WINDSHIELDS

MISC. & YOUTH

KNOW YOUR TERRAIN



- Tread patterns optimized for extreme traction
- Ideal for both hard pack and loose trail



- Flexible "grippy" tread
- Aggressive side bite



- Provides traction and durability
- Built to perform in hard sand, jagged rocks or any other extreme terrain

SUPERIOR PERFORMANCE & DURABILITY

LIFELONG PERFORMANCE

- Every tire is designed and constructed with longevity in mind
- 3,000+ mile rated (4,828 kilometers)

PREMIUM PROTECTION

- Pro Armor makes tires with extra protection exactly where it's needed most—the sidewall
- Triple-belted sidewalls keep your tires more resistant so you can keep going

TOUGHEST TIRES

- Higher ply ratings mean added protection
- Pro Armor builds 8 or 10-ply rated tires for higher puncture-resistance



KNOW YOUR TIRES

DIMENSIONS			TREAD DEPTH	TIRE WEIGHT	PLY RATING	SIDEWALL BELTS	LOAD RATING
TIRE HEIGHT	TIRE WIDTH	WHEEL DIAMETER					
32" x 9"	R15	FRONT/REAR	30 mm	18 kg	10	3	499 kg
Part Number							
USAGE Where can you use the tire			TREAD DEPTH Deeper treads have more grip in all conditions	TIRE WEIGHT A lighter tire makes for improved vehicle performance	PLY RATING Indicates tire puncture-resistance	SIDEWALL BELTS Increase your resistance to sidewall punctures	LOAD RATING How much weight can the tire handle



- Extra deep treads
- Self-cleaning lugs



- Paddles provide traction and durability in soft sand
- Built to float on top of sand



- Industry leading anti-puncture side walls
- Purpose-built, long lasting tread patterns



- Handles extreme cold
- Holds shape and provides traction

WAYS TO SHOP WHEELS & TIRES

TIRES BY SIZE

26"	27"	28"	29"	30"	32"	33"
DUAL THREAT	MUD XC	ATTACK 2.0	MUD XC	ATTACK 2.0	DUAL THREAT	CRAWLER XR
ATTACK	WHITEOUT	DUNE	DUAL THREAT	SAND	CRAWLER XG	PRO RUNNER
		CRAWLER XG	HD-K	SAND XT	CRAWLER XR	
		CRAWLER XR		CRAWLER XG	SAND XT	
				WHITEOUT	PRO RUNNER	
				PRO RUNNER	MUD XT	

TIRES BY TERRAIN

TRAIL	ROCK	DESERT	MUD	DUNES	SNOW
ATTACK 2.0	ATTACK 2.0	ATTACK 2.0	MUD XC	DUNE	ATTACK 2.0
ATTACK	DUAL THREAT	ATTACK	MUD XT	SAND	ATTACK
DUAL THREAT	CRAWLER XR	DUAL THREAT		SAND XT	WHITEOUT
MUD XC	CRAWLER XG	CRAWLER XR			HD-K
CRAWLER XR	PRO RUNNER	CRAWLER XG			
CRAWLER XG		PRO RUNNER			
PRO RUNNER					
HD-K					

WHEELS BY SIZE

14"	15"	16"
40-SERIES (9 TIRE OPTIONS)	50-SERIES (8 TIRE OPTIONS)	60-SERIES (1 TIRE OPTION)
4201 (AMPLIFY)	5201 (CYCLONE)	6301 (REVOLVER)
4202 (BUCKLE)	5202 (FLARE)	
4301 (COMBAT)	5301 (HALO)	
4203 (REBLR)	5203 (HEXLR)	
4204 (SHACKLE)	5101 (WHITEOUT)	
4205 (SIXR)	5204 (WYDE)	
4206 (SPLIT)	5205 (KNIGHT)	
HD DUAL BEADLOCK		

KNOW YOUR WHEELS

STEP 1: SELECT YOUR SERIES

4 = 40-SERIES 5 = 50-SERIES 6 = 60-SERIES

STEP 2: CHOOSE YOUR LOAD RATING

1 = <800 LBS 2 = 801 - 1,300 LBS 3 = 1,301 - 1,600+ LBS

STEP 3: PICK YOUR STYLE

OFFSET / BEADLOCK / COLOR

INCREASE OFFSET FROM STOCK = NARROWER STANCE
DECREASE OFFSET FROM STOCK = WIDER STANCE

COMMON

LIGHTING

ROOF COMMAND
& AUDIO

WHEELS & TIRES

VEHICLE & RIDER
PROTECTION

COOLERS

COCKPIT
ACCESSORIES

WINDSHIELDS

MISC & YOUTH

TIRES



FRONT/REAR

PRO ARMOR ATTACK 2.0

- Engineered for excellent hard-pack performance
- Dual-compound technology and radial construction offer performance in all terrains
- Tight thread pattern for quieter ride

		TREAD DEPTH	TIRE WEIGHT	PLY RATING	SIDEWALL BELTS	LOAD RATING
15"	28" x 10" R15 5416344	25 mm	15 kg	10	3	499 kg
FRONT/REAR						
15"	30" x 10" R15 5416345		17 kg			560 kg



WHEEL SIZE

15"

ATTACK 2.0

TIGHTER TREAD PATTERN =
Better traction in hard pack

DUAL-DUROMETER LUG =
Increased grip & traction in rough terrain, smoother ride in all terrain

10-PLY RATED =
Increased durability

LARGER SIZE OFFERING IN 28" =
More ground clearance & trail traction



FRONT/REAR

PRO ARMOR ATTACK

- The best all-purpose tire for all-season traction in any terrain
- Unique, full-face tread design
- Harder durometer lugs promote extended wear, increasing tire life
- Wider spaced lugs provide more grip in softer terrain

		TREAD DEPTH	TIRE WEIGHT	PLY RATING	SIDEWALL BELTS	LOAD RATING
14"	26" x 9" R14 5415613	23 mm	13 kg	8	3	413 kg
FRONT						
14"	26" x 11" R14 5415614		15 kg			599 kg



WHEEL SIZE

14"



FRONT/REAR

PRO ARMOR DUAL-THREAT

- Dual-compound technology and radial construction offer performance in all terrains
- Softer durometer rubber on outer edge for overall superior grip and feel
- Harder durometer rubber in the middle for increased traction during acceleration and longer tread life

		TREAD DEPTH	TIRE WEIGHT	PLY RATING	SIDEWALL BELTS	LOAD RATING
14"	26" x 9" R14 5416340	FRONT	12 kg	10	3	413 kg
14"	26" x 11" R14 5416341	REAR	14 kg			504 kg
14"	29" x 9" R14 5416342	FRONT	14 kg			504 kg
14"	29" x 11" R14 5416343	REAR	16 kg			599 kg
15"	32" x 10" R15 5416753	FRONT/ REAR	17 kg			902 kg



WHEEL SIZE

14"

15"

**DUAL-COMPOUND =
MORE GRIP + LONGER LIFE**

Firmer
Durometer
Rubber =
Longer Life



Softer
Durometer
Rubber =
More Grip



FRONT/REAR

PRO ARMOR MUD XC

- Designed for the perfect mud-trail crossover for a smooth ride on the trail and aggressive traction in the mud
- Dual-compound technology with harder durometer lugs promote extended wear, increasing tire life
- 10-ply construction means added protection in the toughest terrain

		TREAD DEPTH	TIRE WEIGHT	PLY RATING	SIDEWALL BELTS	LOAD RATING
14"	27" x 9" R14 5416947	FRONT	14 kg	10	3	531 kg
14"	27" x 11" R14 5416948	REAR	15 kg			599 kg
14"	29" x 10" R14 5416946	FRONT/ REAR	18 kg			630 kg



WHEEL SIZE

14"

TIRES



FRONT

REAR

PRO ARMOR DUNES

- 28" flotation across the dunes
- Lightweight 12-paddle rear tires tout a flexible sidewall for flotation and acceleration
- 3-tiered front tire design delivers hard-turning bite and straight-line tracking

		TREAD DEPTH	TIRE WEIGHT	PLY RATING	SIDEWALL BELTS	LOAD RATING
14"	28" x 9" R14 5415533	FRONT 12.8 mm	9 kg	8	2	288 kg
14"	28" x 11" R14 5415534	REAR 31 mm	9 kg			



WHAT PADDLE ARE YOU?



12 PADDLE

- 28" for RZR 900
- 30" for non-Turbo RZR models



FRONT

REAR

PRO ARMOR SAND 12XT

- Unique 3-tier concave design on front tires
- Wider rear tires for more traction and better grip and flotation on the sand
- 12 paddles for optimized performance on non-Turbo models
- 28 mm paddle depth specifically designed for increased traction while limiting sand throw

		TREAD DEPTH	TIRE WEIGHT	PLY RATING	SIDEWALL BELTS	LOAD RATING
14"	30" x 11" R14 5415251	FRONT 12.8 mm	10 kg	8	2	388 kg
14"	30" x 13" R14 5416948	REAR 28 mm	11 kg			





FRONT

REAR

PRO ARMOR SAND

- 30" and 16 paddles optimized to carve up the biggest dunes
- 16 paddles directly deliver the HP to the sand for high-performance dune riding
- Unique 3-tiered front tire design delivers hard-turning bite and straight-line tracking
- Lightweight and flexible sidewalls ensure full contact with the sand in the rear

		TREAD DEPTH	TIRE WEIGHT	PLY RATING	SIDEWALL BELTS	LOAD RATING	
19"	30" x 11" R14 5415251	FRONT	12.8 mm	10 kg	8	2	388 kg
14"	30" x 14" R14 5415252	REAR	31 mm	15 kg			



WHEEL SIZE

14"



16 PADDLE

- 30" for Turbo RZR models
- 32" for Turbo S and Velocity



FRONT

REAR

PRO ARMOR SAND 16XT

- Unique 3-tier concave design on front tires
- Wider rear tires and more paddles with more traction and better grip and flotation on the sand
- 16 paddles for optimized performance and traction on Turbo models
- 28 mm paddle depth specifically designed for increased traction while limiting sand throw

		TREAD DEPTH	TIRE WEIGHT	PLY RATING	SIDEWALL BELTS	LOAD RATING	
16"	30" x 11" R15 5416951	FRONT	13 mm	10 kg	4	2	388 kg
16"	30" x 14" R15 5416953	REAR	28 mm	15 kg			
16"	32" x 12" R15 5416952	FRONT	13 mm	12 kg			463 kg
16"	32" x 15" R15 5416950	REAR	28 mm	16 kg			581 kg



WHEEL SIZE

15"

TIRES



FRONT/REAR

PRO ARMOR CRAWLER XR

- Wanna race? This tire grips it all, from the trail to the rocks
- Square block profile for even surface contact
- A tougher durometer than the XG to take on the toughest the trail has to offer

		TREAD DEPTH	TIRE WEIGHT	PLY RATING	SIDEWALL BELTS	LOAD RATING
14"	28" x 10" R14 5415536	FRONT/ REAR	15 kg	8	3	517 kg
	32" x 10" R15 5416114		18 kg			630 kg
33" x 10" R15 5417174	18 kg		630 kg			

NEW



WHEEL SIZE

14" 15"

WHAT CRAWLER ARE YOU?

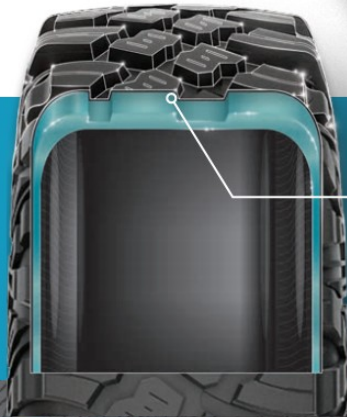

XR SINGLE DUROMETER

- Smaller lug height and single durometer gives this high-speed tire added rigidity and lateral stability when cornering
- Unique lug design excels in hard-packed, fast terrain





FRONT/REAR

PRO ARMOR CRAWLER XG

- Big or small, these tires crawl them all
- A soft, sticky compound makes this tire ideal for both rock crawling and desert running
- 8-ply, triple-belted ballistic sidewalls resist punctures

		TREAD DEPTH	TIRE WEIGHT	PLY RATING	SIDEWALL BELTS	LOAD RATING	
14"	30" x 10" R14 5415616	FRONT/ REAR	20 mm	8	3	17 kg	
14"	32" x 10" R14 5416113					19 kg	644 kg
15"	28" x 10" R15 5416346					15 kg	499 kg
16"	30" x 10" R15 5416397					18 kg	581 kg
16"	32" x 10.5" R16 5416401					20 kg	644 kg



WHEEL SIZE



XG DUAL-DUROMETER

- Taller lug height and dual-durometer construction
- Perfect balance between high-speed performance, durability and flex in order to grip slick rock



FRONT/REAR

NEW PRO ARMOR PRO RUNNER

- Designed to be light weight, high performance, and quicker in corners and flats
- Triple-belted sidewalls offer extra protection where it's needed the most
- Lug separation provides a great grip and an easy clean in mud and sand

		TREAD DEPTH	TIRE WEIGHT	PLY RATING	SIDEWALL BELTS	LOAD RATING	
16"	30" x 9" R15 5417531	FRONT/ REAR	14 mm	8	3	13 kg	
16"	32" x 9.5" R15 5417532					16 kg	630 kg
16"	33" x 9.5" R15 5417533					17 kg	671 kg



WHEEL SIZE



TIRES



FRONT/REAR

NEW

PRO ARMOR MUD XT

- Aggressive traction in the mud
- Dual-compound technology with harder durometer lugs to promote extended wear and increase tire life
- 10-ply construction, means added protection in the toughest terrain

		TREAD DEPTH	TIRE WEIGHT	PLY RATING	SIDEWALL BELTS	LOAD RATING	
15"	32" x 9" R15 5417530	FRONT/ REAR	30 mm	18 kg	10	3	599 kg



WHEEL SIZE

15"



FRONT/REAR

NEW

PRO ARMOR HD-K

- Designed to provide a smooth ride and aggressive traction in all riding terrains
- Triple belted sidewall provides extreme sidewall protection and extends the tire life
- Quad belt tread core offers superior protection and longer tread life

		TREAD DEPTH	TIRE WEIGHT	PLY RATING	SIDEWALL BELTS	LOAD RATING	
14"	29" x 10" R14 5417507	FRONT/ REAR	31.75 mm	18 kg	10	3/1 Aramid	599 kg



WHEEL SIZE

14"

DIESELSeller
"...TIRES ARE UNSTOPPABLE IN SNOW."

- Heavy D.



FRONT/REAR

PRO ARMOR WHITEOUT

- Extra wide tires for flotation in snow
- Cross-hatched tread pattern designed for superior snow traction with limited digging
- 2-ply sidewall designed to balloon for maximum use of its 15" wide contact patch
- Stud compatible

		TREAD DEPTH	TIRE WEIGHT	PLY RATING	SIDEWALL BELTS	LOAD RATING
16"	30" x 15" R15 5416395	FRONT/ REAR	17 mm	21 kg	2	531 kg
14"	27" x 14" R14 5416032	FRONT	16 mm	11 kg	8	



MORE SURFACE AREA FOR BETTER FLOTATION ON SNOW

Snow-specific tire for trails and deep powder. Features an extra wide, bias-ply construction that can run at low pressures for maximum flexibility. High-flotation performance maintains critical vehicle ground clearance in the snow.



BEADLOCK INCLUDED



BEADLOCK INCLUDED



BEADLOCK REQUIRED



16"

15"

60-SERIES

A 6301 BEADLOCK (REVOLVER)

WEIGHT: 8.6 kg | LOAD RATING: 726 kg | OFFSET: +38

ACCENT: FRONT/REAR 16" x 7" 1523286
MATTE BLACK: FRONT/REAR 16" x 7" 1523285

50-SERIES

B 5201 (CYCLONE)

WEIGHT: 7.8 kg | LOAD RATING: 590 kg | OFFSET: +4

ACCENT: FRONT/REAR 15" x 7" 1523184-266
MATTE BLACK: FRONT/REAR 15" x 7" 1523184-458

F 5101 (WHITEOUT) O

WEIGHT: 6.6 kg | LOAD RATING: 363 kg | OFFSET: -5

MATTE BLACK: FRONT/REAR 15" x 10" 1523149-458

KNOW YOUR WHEELS

STEP 1: SELECT SERIES

- 4 = 40-SERIES
- 5 = 50-SERIES
- 6 = 60-SERIES

STEP 2: CHOOSE LOAD RATING

- 1 = <800 LBS
- 2 = 801 - 1,300 LBS
- 3 = 1,301 - 1,600+ LBS

STEP 3: PICK STYLE

OFFSET / BEADLOCK / COLOR

INCREASE OFFSET FROM STOCK = NARROWER STANCE
DECREASE OFFSET FROM STOCK = WIDER STANCE

C 5202 (FLARE)

WEIGHT: 8.1 kg | LOAD RATING: 590 kg | OFFSET: +4

ACCENT: FRONT/REAR 15" x 7" 1523102-266
MATTE BLACK: FRONT/REAR 15" x 7" 1523102-458

G 5204 (WYDE) O

WEIGHT: 6.1 kg | LOAD RATING: 590 kg | OFFSET: +55

MATTE BLACK: FRONT/REAR 15" x 7" 1522550-458

D 5301 BEADLOCK (HALO)

WEIGHT: 7.7 kg | LOAD RATING: 726 kg | OFFSET: +38

ACCENT: FRONT/REAR 15" x 7" 1523282
MATTE BLACK: FRONT/REAR 15" x 7" 1523266

H 5205 (KNIGHT)

FRONT WEIGHT: 6.8 kg | LOAD RATING: 408.2 kg | OFFSET: -4
REAR WEIGHT: 9.1 kg | LOAD RATING: 408.2 kg | OFFSET: -38

MATTE BLACK: FRONT 15" x 8" 1523727-458
REAR 15" x 10" 1523728-458

E 5203 BEADLOCK (HEXLR) O

WEIGHT: 7.3 kg | LOAD RATING: 590 kg | OFFSET: +38

MATTE BLACK: FRONT/REAR 15" x 7" 1522435-458



POLARIS CAPS

LUSTER	ALL WHEELS EXCEPT 5204 (WYDE) & 5203 (HEXLR)	1521509-410
MATTE BLACK		1521509-521
LUSTER	5203 (HEXLR)	1522243-410
MATTE BLACK		1522243-458
HD MATTE BLACK	ALL WHEELS	5457498-458

PRO ARMOR CAPS

LUSTER	ALL WHEELS EXCEPT 5204 (WYDE) & 5203 (HEXLR)	5453209-410
MATTE BLACK		5453209-458
MATTE BLACK	5204 (WYDE) & THRASHER	1523063-458
LUSTER	THRASHER & 5203 (HEXLR)	1523015-410
MATTE BLACK		1523015-458

LUG NUTS

12 mm x 1.5 SPLINED LUG NUTS

16 LUG NUTS WITH WRENCH	TURBO S '18-21, XP TURBO '19-21, 4 TURBO S '20-21, XP 4 TURBO '19-21, XP 4 1000 '14-21, XP 1000 '14-21, S 900 '15-20, S 4 1000 '19-20, S 1000 '16-20, PRO XP '21, 900 '14-20	2879332
4 LUG NUTS WITHOUT WRENCH		2879331
SPLINED LUG WRENCH	TURBO S '18-21, XP TURBO '19-21, 4 TURBO S '20-21, XP 4 TURBO '19-21, XP 4 1000 '14-21, XP 1000 '14-21, S 900 '15-20, S 4 1000 '19-20, S 1000 '16-20, RS1 '18-21, PRO XP '21, 900 '14-20	2204966

WHEELS



14"

40-SERIES

I 4201 (AMPLIFY) ○

FRONT WEIGHT: 5.9 kg | LOAD RATING: 408.2 kg | OFFSET: +4
REAR WEIGHT: 6.4 kg | LOAD RATING: 590 kg | OFFSET: -9

ACCENT: FRONT 14" x 7" 1522956-266
REAR 14" x 8" 1522957-266
MATTE BLACK: FRONT 14" x 7" 1522956-458
REAR 14" x 8" 1522957-458

DOES NOT FIT XP 1000/TURBO '18-19 AND XP 4 1000/TURBO '18-19

J 4202 (BUCKLE) ○

FRONT WEIGHT: 5.8 kg | LOAD RATING: 408.2 kg | OFFSET: +4
REAR WEIGHT: 6.1 kg | LOAD RATING: 590 kg | OFFSET: -9

ACCENT: FRONT 14" x 7" 1522544-266
REAR 14" x 8" 1522545-266
MATTE BLACK: FRONT 14" x 7" 1522544-458
REAR 14" x 8" 1522545-458

DOES NOT FIT XP 1000/TURBO '18-19 AND XP 4 1000/TURBO '18-19

K 4301 BEADLOCK (COMBAT) ○

WEIGHT: 7.3 kg | LOAD RATING: 726 kg | OFFSET: +38

ACCENT: FRONT/REAR 14" x 7" 1523284
MATTE BLACK: FRONT/REAR 14" x 7" 1523283
DOES NOT FIT XP 1000/TURBO '18-19 AND XP 4 1000/TURBO '18-19

L 4203 BEADLOCK (REBLR) ○

FRONT WEIGHT: 5.9 kg | LOAD RATING: 408.2 kg | OFFSET: +4
REAR WEIGHT: 6.6 kg | LOAD RATING: 590 kg | OFFSET: -9

MATTE BLACK: FRONT 14" x 7" 1522238-458
REAR 14" x 8" 1522239-458

M 4204 (SHACKLE) ○

FRONT WEIGHT: 5.9 kg | LOAD RATING: 408.2 kg | OFFSET: +4
REAR WEIGHT: 6.4 kg | LOAD RATING: 590 kg | OFFSET: -9

ACCENT: FRONT 14" x 7" 1522546-266
REAR 14" x 8" 1522547-266
MATTE BLACK: FRONT 14" x 7" 1522546-458
REAR 14" x 8" 1522547-458

N 4205 (SIXR) ○

FRONT WEIGHT: 4.8 kg | LOAD RATING: 408.3 kg | OFFSET: +4
REAR WEIGHT: 5.7 kg | LOAD RATING: 590 kg | OFFSET: -9

MATTE BLACK: FRONT 14" x 7" 1521507-521
REAR 14" x 8" 1521508-521
LUSTER: FRONT 14" x 7" 1521507-410
REAR 14" x 8" 1521508-410

O 4206 (SPLIT) ○

FRONT WEIGHT: 4.3 kg | LOAD RATING: 408.2 kg | OFFSET: +4
REAR WEIGHT: 4.9 kg | LOAD RATING: 590 kg | OFFSET: -9

MATTE BLACK: FRONT 14" x 6" 1522542-458
REAR 14" x 8" 1522543-458

P HD DUAL BEADLOCK

WEIGHT: 18.1 kg | LOAD RATING: 725.7 kg | OFFSET: +28

MATTE BLACK: FRONT/REAR 14" x 7" 1524022-458

○ LUG NUTS REQUIRED

.95 cm - 24 HEX LUG NUTS

16 HEX LUG NUTS	570 13-21	2877409
4 HEX LUG NUTS		2876754



FORGED BEADLOCK RINGS

14" BEADLOCK RINGS

4203 (REBLR) ONLY (EACH INCLUDES BOLTS)

VOODOO BLUE: 1522244-619
MACHINED: 1522244-266
WHITE: 1522244-133
INDY RED: 1522244-293
ORANGE CRUSH: 1522244-589
4301 (COMBAT) REPLACEMENT MATTE BLACK: 1523146-458

15" BEADLOCK RINGS

5203 (HEXLR) ONLY (EACH INCLUDES BOLTS)

VOODOO BLUE: 1522240-619
MACHINED: 1522240-266
WHITE: 1522240-133
INDY RED: 1522240-293
ORANGE CRUSH: 1522240-589
5301 (HALO) REPLACEMENT MATTE BLACK: 1523147-458



COMMON

LIGHTING

ROCK COMMAND & AUDIO

WHEELS & TIRES

VEHICLE & RIDER PROTECTION

COOLERS

COCKPIT ACCESSORIES

WINDSHIELDS

MISC & YOUTH

KNOW YOUR TERRAIN



- Tread patterns optimized for extreme traction
- Ideal for both hard pack and loose trail



- Flexible "grippy" tread
- Aggressive side bite



- Provides traction and durability
- Built to perform in hard sand, jagged rocks or any other extreme terrain

WHEEL & TIRE SETS

14"

40-SERIES

BACKCOUNTRY/TRAIL

MUD

	DUAL-THREAT 26"	DUAL-THREAT 29"	ATTACK 26"	MUD XC 27"	MUD XC 29"
4201 (AMPLIFY) <i>Accent</i>	2883138	2883146	2882390	2884272	2884265
4201 (AMPLIFY) <i>Matte Black</i>	2883139	2883147	2882391	2884273	2884266
4202 (BUCKLE) <i>Accent</i>	2883140	2883148	2881335	2884267	2884260
4202 (BUCKLE) <i>Matte Black</i>	2883141	2883149	2881336	2884268	2884261
4301 (COMBAT) <i>Accent</i> BEADLOCKS PRE-MOUNTED	2883217	2883219			
4301 (COMBAT) <i>Matte Black</i> BEADLOCKS PRE-MOUNTED	2883216	2883218			
4203 (REBLR) <i>Matte Black</i> BEADLOCKS SOLD SEPARATELY			2881381		
4204 (SHACKLE) <i>Accent</i>	2883142	2883150	2881347	2884270	2884263
4204 (SHACKLE) <i>Matte Black</i>	2883143	2883151	2881348	2884271	2884264
4205 (SIXR) <i>Luster</i>			2881359		
4205 (SIXR) <i>Matte Black</i>	2883144	2883152	2881360	2884269	2884262
4206 (SPLIT) <i>Matte Black</i>	2883145	2883153	2881404		

15"

50-SERIES

BACKCOUNTRY/TRAIL MUD

DESERT/ROCK

	DUAL-THREAT 32"	ATTACK 2.0 28"	ATTACK 2.0 30"	MUD XT 32"	PRO RUNNER 30"	PRO RUNNER 32"	PRO RUNNER 33"	CRAWLER XG 28"
5201 (CYCLONE) <i>Accent</i>	2883694	2883160	2883169					2883188
5201 (CYCLONE) <i>Matte Black</i>	2883693	2883159	2883168					2883187
5202 (FLARE) <i>Accent</i>	2883696	2883158	2883167	2885052	2885024	2885031	2885038	2883186
5202 (FLARE) <i>Matte Black</i>	2883695	2883157	2883166	2885053	2885025	2885032	2885039	2883185
5301 (HALO) <i>Accent</i> BEADLOCKS PRE-MOUNTED	2883698	2883162	2883171	2885054	2885026	2885033	2885040	2883190
5301 (HALO) <i>Matte Black</i> BEADLOCKS PRE-MOUNTED	2883697	2883161	2883170	2885055	2885027	2885034	2885041	2883189
5203 (HEXLR) <i>Matte Black</i> BEADLOCKS SOLD SEPARATELY	2883699	2883154	2883163	2885056	2885028	2885035	2885042	2883182
5204 (WYDE) <i>Matte Black</i>	2883700	2883155	2883164	2885058	2885030	2885037	2885044	2883183

16"

60-SERIES

ROCK/RACE

	CRAWLER XG 32"
6301 (REVOLVER) <i>Accent</i> BEADLOCKS PRE-MOUNTED	2883703
6301 (REVOLVER) <i>Matte Black</i> BEADLOCKS PRE-MOUNTED	2883702

2 WAYS TO PURCHASE INDIVIDUAL WHEELS & TIRES - OR - COMPLETE SETS AS LISTED

Exclusively at Polaris Authorized Dealers

⊖ LUG NUTS REQUIRED. SEE P. 62 FOR CAPS, BEADLOCK RINGS & LUG NUTS



- Extra deep treads
- Self-cleaning lugs



- Paddles provide traction and durability in soft sand
- Built to float on top of sand



- Industry leading anti-puncture side walls
- Purpose-built, long lasting tread patterns



- Handles extreme cold
- Holds shape and provides traction

COMMON

DESERT/ROCK

CRAWLER XG 30"



CRAWLER XG 32"



CRAWLER XR 28"



DUNES/SAND

DUNE 28"



SAND 30"



SAND 12XT 30"



2882396	2882452	2882394	2882400	2882398	
2882397	2882451	2882395	2882401	2882399	
2881560	2882448	2881343	2881345	2881339	
2881561	2882447	2881344	2881346	2881340	
2883211	2883215	2883213			
2883210	2883214	2883212			
	2881382	2881386	2881387	2881384	
2881558	2882450	2881355	2881357	2881351	
2881559	2882449	2881356	2881358	2881352	2884034
2881564		2881371		2881365	
2881563	2882453	2881372		2881366	
			2881407	2881406	

CRAWLER XG 30"



CRAWLER XR 32"



NEW
CRAWLER XR 33"



SNOW

WHITEOUT 30"



DUNES/SAND

SAND 16XT 30"



SAND 16XT 32"



2883179	2883194	2884744	5101 (WHITEOUT) <i>Matte Black</i>	2883172	5205 (KNIGHT) <i>Matte Black</i>	2884035	2884036
2883178	2883193	2884736					
2883177	2883192	2884737					
2883176	2883191	2884738					
2883181	2883196	2884739					
2883180	2883195	2884740					
2883173	2882444	2884741					
2883174	2882445	2884743					

PERFORMANCE

FRONT SWAY BAR KIT

- » 2881205-458
XP TURBO '15-21, XP 4 TURBO '16-21, XP 4 1000 '16-21, XP 1000 '16-21
DOES NOT WORK WITH HIGH CLEARANCE A-ARMS



VALVES



COLBY SHORT ULTIMATE VALVE (2 PACK)

- » 2883292



COLBY EMERGENCY VALVE (2 PACK)

- » 2883293



COLBY COMBO VALVE KIT (16 PACK)

- Includes 8 Ultimate valves and 8 Emergency valves
- » 2883294

ALL VALVES FIT TURBO S '18-21, XP TURBO '19-21, 4 TURBO S '20-21, XP 4 TURBO '19-21, XP 4 1000 '14-21, XP 1000 '14-21, S 900 '15-20, S 4 1000 '19-20, S 1000 '16-20, PRO XP '21, 900 '14-20

LIGHTING

RISE COMMAND & AUDIO

WHEELS & TIRES

VEHICLE & RIDER PROTECTION

COOLERS

COCKPIT ACCESSORIES

WINDSHIELDS

MISC & YOUTH



> VEHICLE & RIDER PROTECTION

WHEN PUSHING LIMITS

in punishing off-road environments, keep your RZR protected from harsh hits and damage with an added layer of protection and peace of mind.

HMW FRONT A-ARM GUARDS

- » 2880274
S 900 '15-20, S 4 1000 '19-20, S 1000 '16-20, 900 '15-20
- » 2880170
900 '14-20
- » 2879454
XP TURBO '15-21, XP 4 TURBO '16-21, XP 4 1000 '14-21, XP 1000 '14-21

HMW SKID PLATE

- » 2-SEAT • 2880290
S 900 '15-20, S 1000 '16-20, 900 '14-20
- » 2-SEAT • 2881615
XP TURBO '15-21, XP 1000 '14-21
- » 4-SEAT • 2881725
XP 4 TURBO '16-21, XP 4 1000 '14-21
TO FIT '14-'15 ADAPTER BRACKET KIT 2206329 IS REQUIRED

TOUGH .95 cm THICK DESIGN WITHSTANDS THE TOUGHEST IMPACTS

CUSTOM CONTOURED FOR A PERFECT FIT TO RETAIN MAXIMUM GROUND CLEARANCE

HMW REAR TRAILING ARM GUARDS

- » 2879496
XP 4 1000 '14-21, XP 1000 '14-21, XP 4 TURBO '16-21, XP TURBO '15-21, RS1 '18-21

HMW REAR A-ARM GUARDS

- » 2880171
S 900 '15-20, S 4 1000 '19-20, S 1000 '16-20, 900 '15-20
- » 2880172
900 '14-20



COMMON

LIGHTING

RISE COMMAND
& AUDIO

WHEELS & TIRES

VEHICLE & RIDER
PROTECTION

COOLERS

COCKPIT
ACCESSORIES

WINDSHIELDS

MISC. & YOUTH



FULL COVERAGE FENDER FLARES TOP SELLER

- Keep the mud, dirt, and debris from launching off the tires and into your face
- Includes 2, front only

» 2881985
TURBO S '18-21, 4 TURBO S '19-21, XP TURBO '15-21, XP 4 TURBO '16-21, XP 1000 '14-21, XP 4 1000 '14-21, S 900 '15-20, S 4 1000 '19-20, S 1000 '16-20, 900 '14-20



MUD FLAPS (FRONT ONLY)

- Keeps the front wheels from flipping mud into the cab
- Rigid injection-molded design to eliminate warping in high-heat conditions
- Designed to specifically integrate into front fender flares

• Includes 2
» 2879938
TURBO S '18-21, 4 TURBO S '19-21, XP TURBO '15-21, XP 4 TURBO '16-21, XP 1000 '14-21, XP 4 1000 '14-21, S 900 '15-20, S 4 1000 '19-20, S 1000 '16-20, 900 '14-20



FENDER FLARE KIT

- Stock replacement for 900 Models
- Front and Rear Fender Flares (includes 4)

» 2879434
900 '14-20



INTRUSION BAR

» 2879181
S 900 '15-20, S 4 1000 '19-20, S 1000 '16-20, 900 '14-20
DOES NOT WORK WITH ANY FULL WINDSHIELD
DOES NOT WORK WITH LED UNDER ROOF LIGHT BAR MOUNT (2881203, 2881553)



BUMPER ADAPTER

- Connects the Upper Cab Frame Extension (2880411) with rear bumper, each sold separately

» 2880165
S 900 '15-20, S 4 1000 '19-20, S 1000 '16-20, 900 '14-20



REAR CAB FRAME EXTENSION

» UPPER • 2880411 » LOWER • 2880412
S 900 '15-20, S 1000 '16-20, 900 '14-20
STANDARD ON S 4 1000.

SEE P. 32 FOR

POLARIS
NORTHSTAR
COOLER

KEEP IT
ICE COLD



28, 57 & 99
LITER FEATURES

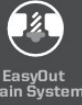

99 LITER

- » GRAPHITE • 2883426
- » DESERT • 2883392



57 LITER

- » GRAPHITE • 2883425
- » DESERT • 2881259



28 LITER

- » GRAPHITE • 2883424
- » DESERT • 2881315

ESSENTIAL ACCESSORIES SO YOUR COOLER WORKS AS HARD AS YOU DO

COOLER ACCESSORIES	99 LITER	57 LITER	28 LITER
<p>WIRE BASKET</p>	2883648	2882185	2882438
<p>DIVIDERS Doubles as cutting board</p>	2883468 COMES WITH ONE DIVIDER 1 way to partition	2882184 COMES WITH TWO DIVIDERS 2 ways to partition	2882186 COMES WITH ONE DIVIDER 1 way to partition
<p>SEAT CUSHION</p>	NOT AVAILABLE	2882179	2882507
<p>WHEELS</p>	2883967	2882180	NOT AVAILABLE

GRIZZLY TESTED. POLARIS APPROVED.



This cooler is IGBC-approved, meaning it withstands the power expended by a typical grizzly bear if it was trying to get inside.

Seriously, there are experts who know what a grizzly is capable of doing, and they certify our coolers can take it.



POLARIS NORTHSTAR COOLERS CAN SURVIVE JUST ABOUT ANYTHING - FROM EXTREME HEAT TO A NASTY TUMBLE OFF A VEHICLE.



14 LITER

» GRAPHITE • 2883968



19 LITER SOFTSIDE

» GRAPHITE • 2883390

DON'T FORGET THESE ACCESSORIES



887 mL

TUMBLERS

» 887 mL • 2883394
» 591 mL • 2883393



28 L NORTHSTAR COOLER BRACKET

» 2884070
PRO, XP 4 '20-21, PRO, XP '20-21

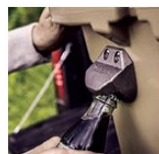

BOTTLE OPENER

» 2882183
ALL COOLERS

COMMON

LIGHTING

RISE COMMAND & AUDIO

WHEELS & TIRES

VEHICLE & RIDER PROTECTION

COOLERS

COCKPIT ACCESSORIES

WINDSHIELDS

MISC & YOUTH

> COCKPIT ACCESSORIES



HARNESSES



CLICK-6 HARNESS

- Racing-quality premium construction for the greatest security and protection
- Six straps hold a driver securely in place in all riding conditions
- One-click, quick-release buckle releases straps, allows easy egress
- Fully adjustable to fit riders of all sizes
- Easy to buckle and adjust, even while wearing helmet and gloves



RZR SUBZERO 4 HARNESS

» DRIVER SIDE 2882281

TURBO S '18-21, XP TURBO '15-21, XP1000 '14-21,
4 TURBO S '19-21, XP 4 TURBO '15-21,
XP 4 1000 '14-21, S 900 '15-20, S 4 1000 '19-20,
S 1000 '16-20, 900 '14-20, PRO XP '20-21,
PRO XP 4 '20-21

» PASSENGER SIDE 2882282

TURBO S '18-21, XP TURBO '15-21, XP 1000 '14-21,
4 TURBO S '19-21, XP 4 TURBO '15-21,
XP 4 1000 '14-21, S 900 '15-20, S 4 1000 '19-20,
S 1000 '16-20, 900 '14-20, PRO XP '20-21,
PRO XP 4 '20-21

DRIVER SIDE

» **TOP SELLER** 2882244

TURBO S '18-21, XP TURBO '19-21,
4 TURBO S '20-21, XP 4 TURBO '21,
XP 1000 '14-21, S 900 '15-20, S 4 1000 '20,
S 1000 '16-20, 900 '14-20

DOES NOT FIT 4-PASSENGER MODELS OR
HIGHLIFTER MODEL

» **NEW** 2884075

PRO XP '20-21

» **NEW** 2884077

PRO XP 4 '20-21

PASSENGER SIDE

» **TOP SELLER** 2882245

TURBO S '18-21, XP TURBO '19-21,
4 TURBO S '20-21, XP 4 TURBO '21,
XP 1000 '14-21, S 900 '15-20, S 4 1000 '20,
S 1000 '16-20, 900 '14-20

DOES NOT FIT 4-PASSENGER MODELS
OR HIGHLIFTER MODEL

» **NEW** 2884076

PRO XP '20-21

» **NEW** 2884078

PRO XP 4 '20-21

4 PASSENGER REAR

» **NEW** 2884079

PRO XP 4 '20-21

MIRRORS



FOLDING SIDE MIRRORS TOP SELLER

- Includes left and right mirrors with mounting brackets and hardware
- Hinges feature breakaway design for tight trail conditions and easy trailering
- Mounts directly to factory roll cage at the bolt location, works with windshields and doors

» 2881198

TURBO S '18-21, XP TURBO '15-21, XP 1000 '14-21, 4 TURBO S '19-21, XP 4 TURBO '15-21, XP 4 1000 '14-21, S 900 '15-20, S 4 1000 '19-20, S 1000 '16-20, 900 '14-20



CONVEX DESIGN DELIVERS WIDE REAR VIEW

REAR VIEW MIRROR TOP SELLER

- Works with all roofs, soft tops and windshields

» 2877945

TURBO S '18-21, XP TURBO '15-21, XP 1000 '14-21, 4 TURBO S '19-21, XP 4 TURBO '15-21, XP 4 1000 '14-21, S 900 '15-20, S 4 1000 '19-20, S 1000 '16-20, 900 '14-20



SCRATCH-RESISTANT GLASS MIRROR LENS

CONVEX REARVIEW MIRROR TOP SELLER

- Installs easily: mount bolts into your choice of pre-designated mounting locations on vehicle frame

- Convex design provides broad, expanded view of what's behind or alongside the vehicle

» 2881540

TURBO S '18-21, XP TURBO '15-21, XP 1000 '14-21, 4 TURBO S '19-21, XP 4 TURBO '15-21, XP 4 1000 '14-21, S 900 '15-20, S 4 1000 '19-20, S 1000 '16-20, 900 '14-20

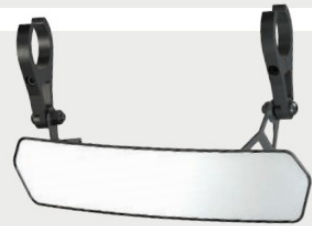

QUICK GLANCE, WIDE-ANGLE VIEWING FOR MAXIMUM VISIBILITY

WIDE-ANGLE REARVIEW MIRROR

- Stamped steel frame and backing plate with large 6.4 cm x 35.6 cm convex mirror
- Up to 10° of adjustability to adjust to rider height or view preference
- Easy over-structure installation with stamped steel mounts

» 2881199

TURBO S '18-21, XP TURBO '15-21, XP 1000 '14-21, 4 TURBO S '19-21, XP 4 TURBO '15-21, XP 4 1000 '14-21, S 900 '15-20, S 4 1000 '19-20, S 1000 '16-20, 900 '14-20

MISC

HORN KIT

» 2880416

TURBO S '18-21, XP TURBO '15-21, XP 1000 '14-21, 4 TURBO S '19-21, XP 4 TURBO '15-21, XP 4 1000 '14-21, S 900 '15-20, S 4 1000 '19-20, S 1000 '16-20, 900 '14-20

» 2877788

570 '12-21



SPARCO PERFORMANCE STEERING WHEEL

» 2884085

TURBO S '18-21, XP TURBO '15-21, XP 1000 '14-21, 4 TURBO S '19-21, XP 4 TURBO '15-21, XP 4 1000 '14-21, S 900 '15-20, S 4 1000 '19-20, S 1000 '16-20, 900 '14-20



ALL WEATHER FLOOR MATS

» FRONT • 2880414

TURBO S '18-21, XP TURBO '15-21, XP 1000 '14-21, 4 TURBO S '19-21, XP 4 TURBO '15-21, XP 4 1000 '14-21, S 900 '15-20, S 4 1000 '19-20, S 1000 '16-20, 900 '14-20

» FRONT & BACK • 2880415

4 TURBO S '19-21, XP 4 TURBO '15-21, XP 4 1000 '14-21, S 4 1000 '19-20

HEATER KIT

» 2881552

S 900 '15-20, S 4 1000 '19-20, S 1000 '16-20, 900 '14-20

SEAT SLIDER

» 2879460

TURBO S '18-21, XP TURBO '15-21, XP 1000 '14-21, 4 TURBO S '19-21, XP 4 TURBO '15-21, XP 4 1000 '14-21, S 900 '15-20, S 4 1000 '19-20, S 1000 '16-20, 900 '14-20

SWITCH PANEL

- Adds five spaces for rocker switches without blocking storage

» 2881987

TURBO S '18-21, XP TURBO '15-21, XP 1000 '14-21, 4 TURBO S '19-21, XP 4 TURBO '15-21, XP 4 1000 '14-21, S 900 '15-20, S 4 1000 '19-20, S 1000 '16-20, 900 '14-20

COMMON

LIGHTING

RISE COMMAND & AUDIO

WHEELS & TIRES

VEHICLE & RIDER PROTECTION

COOLERS

COCKPIT ACCESSORIES

WINDSHIELDS

MISC & YOUTH



> WINCHES

WHETHER HARD AT WORK OR ON THE TRAILS, ADD A WINCH TO...

- GET THE JOB DONE RIGHT
- GET YOU ON YOUR WAY FASTER
- BE PREPARED FOR UNEXPECTED SITUATIONS

WHY POLARIS?



TESTED **1,200+**
PULLS AT MAX LOAD



BUILT TO WITHSTAND
-29° C TEMPERATURES



**OPERATES FULLY
SUBMERGED**



**MILITARY
TESTED & APPROVED**

UPGRADE YOUR CONTROLS

WIRED REMOTE CONTROL

- Must order remote handle and socket together

» REMOTE HANDLE
4013466

» SOCKET
4017102

» SOCKET
4014228

WORKS WITH 2882240,
2883628, 2883825

WORKS WITH 2883825

WORKS WITH 2882240, 2883828

REPLACEMENT PARTS



STEEL CABLE

1,588 kg SERIES - 50 ft.
» 2878890
WORKS WITH 2881671



SYNTHETIC ROPE

2,721 kg SERIES
» 2878888
2,041 kg SERIES
» 2879187

FEATURES

ALL POLARIS ENGINEERED WINCHES COME WITH:



1. Set Dial to FREE SPOOL (N) to attach Winch Hook
2. Set Dial to PULL (L) for Winch Mode
3. Set Dial to ROPE RECOVERY (H) for 5x Faster Rope Recovery

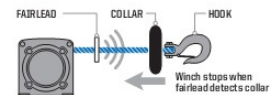

Stops winch at end of pull to prevent driveline stress and plow overlifting



- Lightweight & Easy to Handle
- Superior Flexibility & Strength
- 15 m long



15 m range wireless remote control with unique code for interference-free operation

MODEL

PRO XP 4 / PRO XP '20-21

Includes both wired and wireless remote

XP 1000 '14-21, **XP 4 1000** '14-21

XP TURBO '19-21, **XP 4 TURBO** '15-21

S 900 '15-20, **900** '14-20

S 4 1000 '19-20, **S 1000** '16-20

TURBO S '18-21

4 TURBO S '19-21

RS1 '18-21

PRO PRO HEAVY DUTY SERIES
TOP-OF-THE-LINE FEATURES



PRO PRO HEAVY DUTY SERIES

H-D HEAVY DUTY SERIES
BUILT FOR THE OFF-ROAD



H-D HEAVY DUTY SERIES



INTEGRATED WIRING, MOUNT, PREASSEMBLED

HOOK WITH STRAP

CUT STEEL GEARS & SEALED DRIVETRAIN

SEALED PERMANENT MAGNET MOTOR



WITH ALUMINUM FAIRLEAD

NOT AVAILABLE

WITH STEEL ROLLER FAIRLEAD



ADD AUTO STOP UPGRADE

2881693

SYNTHETIC ROPE REQUIRED



ADD SYNTHETIC ROPE

2878888



ADD WIRELESS REMOTE

2879316



2,721 kg	2,041 kg	1,588 kg	REQUIRED CABLES
2883759	2883758		INCLUDED WITH WINCH
	TOP SELLER 2882240	TOP SELLER 2881671	TURBO 5 '18-21, XP TURBO '19-21, XP 1000 '19-21, 4 TURBO 5 '19-21, XP 4 TURBO '19-21, XP 4 1000 '19-21 REQUIRE WINCH COVER KIT 2884118 S 900 '16-20, S 1000 '16-20, 900 '15-20 2881551 S 4 1000 '19-20 2881646
	2883828		INCLUDED WITH WINCH
	2883825		INCLUDED WITH WINCH
	EXTREME BUMPER (2883783-458) REQUIRED, SOLD SEPARATELY		

> ADDITIONAL ACCESSORIES



MISC



RZR WHIP FLAG & POLE

» 2881468

TURBO S '18-21, XP TURBO '15-21, XP 1000 '14-21, 4 TURBO S '19-21, XP 4 TURBO '15-21, XP 4 1000 '14-21, S 900 '15-20, S 4 1000 '19-20, S 1000 '16-20, 900 '14-20, PRO XP '20-21, PRO XP 4 '20-21

LOCK & RIDE

FLAG MOUNT TOP SELLER

» 2877502

TURBO S '18-21, XP TURBO '19-21, 4 TURBO S '20-21, XP 4 TURBO '19-21, XP 4 1000 '14-21, XP 1000 '14-21, S 900 '15-20, S 4 1000 '19-20, S 1000 '16-20, PRO XP '21, 900 '14-20, 570 '12-21



TURBO HOOD

» 2881467

S 900 '15-20, S 4 1000 '19-20, S 1000 '16-20, 900 '14-20



RIDE & REPAIR ESSENTIALS KIT

» 2881207

TURBO S '18-21, XP TURBO '15-21, XP 1000 '14-21, 4 TURBO S '19-21, XP 4 TURBO '15-21, XP 4 1000 '14-21, S 900 '15-20, S 4 1000 '19-20, S 1000 '16-20, 900 '14-20, PRO XP '20-21, PRO XP 4 '20-21

OFF-ROAD JACK KIT

» 2881201

TURBO S '18-21, XP TURBO '15-21, XP 1000 '14-21, 4 TURBO S '19-21, XP 4 TURBO '15-21, XP 4 1000 '14-21, S 900 '15-20, S 4 1000 '19-20, S 1000 '16-20, 900 '14-20, PRO XP '20-21, PRO XP 4 '20-21



FIRE EXTINGUISHER MOUNT

» 2881200

TURBO S '18-21, XP TURBO '15-21, XP 1000 '14-21, 4 TURBO S '19-21, XP 4 TURBO '15-21, XP 4 1000 '14-21, S 900 '15-20, S 4 1000 '19-20, S 1000 '16-20, 900 '14-20, PRO XP '20-21, PRO XP 4 '20-21

570

LOCK & RIDE FULL WINDSHIELD - POLY

» 2879492
570 '12-21

HALF WINDSHIELD - POLY

» 2879493
570 '12-21

FRONT DELUXE BRUSHGUARD

» 2878284
570 '12-21

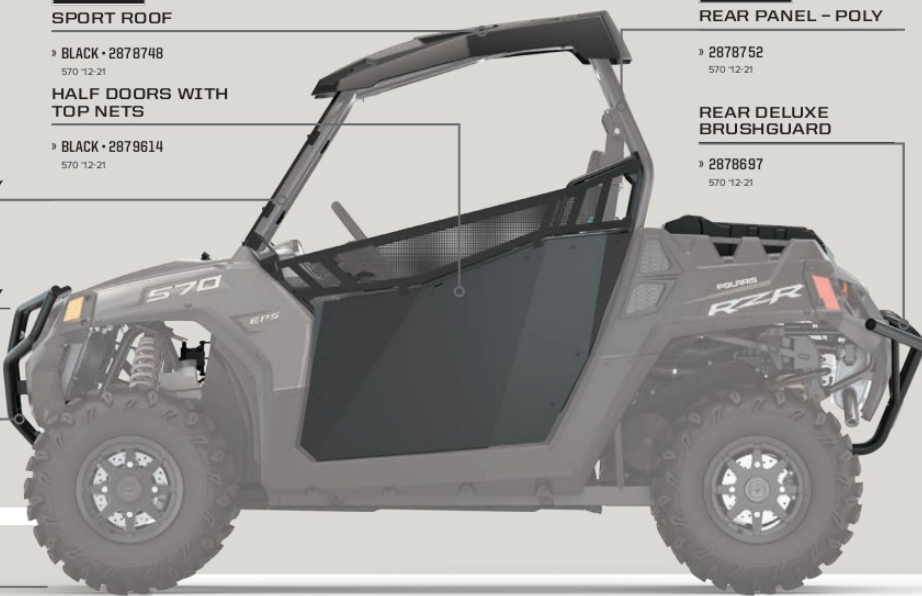

LOCK & RIDE SPORT ROOF

» BLACK • 2878748
570 '12-21

HALF DOORS WITH TOP NETS

» BLACK • 2879614
570 '12-21

LOCK & RIDE REAR PANEL - POLY

» 2878752
570 '12-21

REAR DELUXE BRUSHGUARD

» 2878697
570 '12-21

POLARIS HD 1,588 kg WINCH

- All power cables included in the kit

» 2879334
570 '12-21
BUSBAR HARNESS REQUIRED, SOLD SEPARATELY

SEAT ADJUSTER KIT

» 2877390
570 '12-21

HORN KIT

» 2877788
570 '12-21



LOCK & RIDE CARGO BOX

- Holds and protects riders' gear
- Attaches to the rear cargo bed in 10 seconds
- Rubber gasket seal to keep dirt and moisture out
- Lockable latches, heavy duty hinges, side handles

» 2876439-070
570 '12-21

> YOUTH

170



HALF WINDSHIELD

- Provides protection from rain, debris and branches
- Installs easily and securely
- Retains open-air riding environment
- Adds sporty style

» 2877684
170 '14, '16-20



FRONT BRUSHGUARD

- Strong, tough, and protective
- Styling and finish complement vehicle's look
- Protects front end of vehicle from impact
- Easy bolt-on installation

» 2877813
170 '14, '16-20



SOFT TOP

- Adds sporty styling and offers protection
- Provides shade for riders
- Protects against rain, overhead branches, etc.
- Easy installation

» 2877685
170 '14, '16-20

COMMON

LIGHTING

RIDE COMMAND & AUDIO

WHEELS & TIRES

VEHICLE & RIDER PROTECTION

COOLERS

COCKPIT ACCESSORIES

WINDSHIELDS

MISC & YOUTH

FOR THE LIFE OF YOUR RIDE

MAINTENANCE TIP

BREAK-IN PERIOD

The break-in period for your new RZR is the first 25 hours of operation, or the time it takes to use the first two tanks of fuel. No single action on your part is as important as a proper break-in period. Careful treatment of a new engine will result in more efficient performance and longer life for the engine.

NOTICE: Excessive heat build-up during the first three hours of operation will damage close-fitted engine parts. Do not operate at full throttle or high speeds for extended periods during the first three hours of use.

AIR FILTERS

A clogged air filter can restrict air flow to the engine leading to reduced engine performance, engine life or catastrophic failure.

BRAKE PADS

Maintaining and/or replacing brakes are critical to the safety and functionality of a vehicle. Brake pads should be checked for wear and oil or grease (petroleum products) contamination and brake discs should be checked for cracks, excessive corrosion or warping.

HALF SHAFT

Check for tear and punctures in the boot which can lead to CV joint wear that can contribute to axle failure.



MAINTENANCE SCHEDULE

25 HRS / 400 km

BREAK-IN MAINTENANCE

ENGINE OIL:
CHANGE

GENERAL LUBRICATION:
ALL FITTINGS, PIVOTS, CABLES, ETC.

AIR FILTER:
INSPECT & REPLACE AS NEEDED

EXHAUST SYSTEM:
INSPECT & CLEAN
INSPECT FOR LEAKAGE OR CARBON BUILD UP AT JOINTS

INSPECT & CLEAN SCREEN TYPE SPARK ARRESTOR

50 HRS / 800 km

6 MONTHS

EXHAUST SYSTEM:
INSPECT & CLEAN
INSPECT FOR LEAKAGE OR CARBON BUILD UP AT JOINTS

INSPECT & CLEAN SCREEN TYPE SPARK ARRESTOR

GENERAL LUBRICATION:
ALL FITTINGS, PIVOTS, CABLES, ETC.

DRIVE BELT:
INSPECT & ADJUST
REPLACE AS NEEDED

100 HRS / 1600 km

12 MONTHS

ENGINE OIL:
CHANGE

DRIVE BELT:
INSPECT & ADJUST
REPLACE AS NEEDED

TRANSMISSION FLUID:
CHANGE

AIR FILTER:
INSPECT & REPLACE AS NEEDED

FRONT DRIVE FLUID
CHANGE

150 HRS / 2400 km

18 MONTHS

ENGINE OIL:
CHANGE

BATTERY:
TEST, CLEAN, &
CHECK FLUID LEVEL
REPLACE AS NEEDED

DRIVE BELT:
INSPECT & ADJUST
REPLACE AS NEEDED

TIRES:
INSPECT CONDITION & PRESSURE

EXHAUST SYSTEM:
INSPECT & CLEAN
INSPECT FOR LEAKAGE OR CARBON BUILD UP AT JOINTS

INSPECT & CLEAN SCREEN TYPE SPARK ARRESTOR

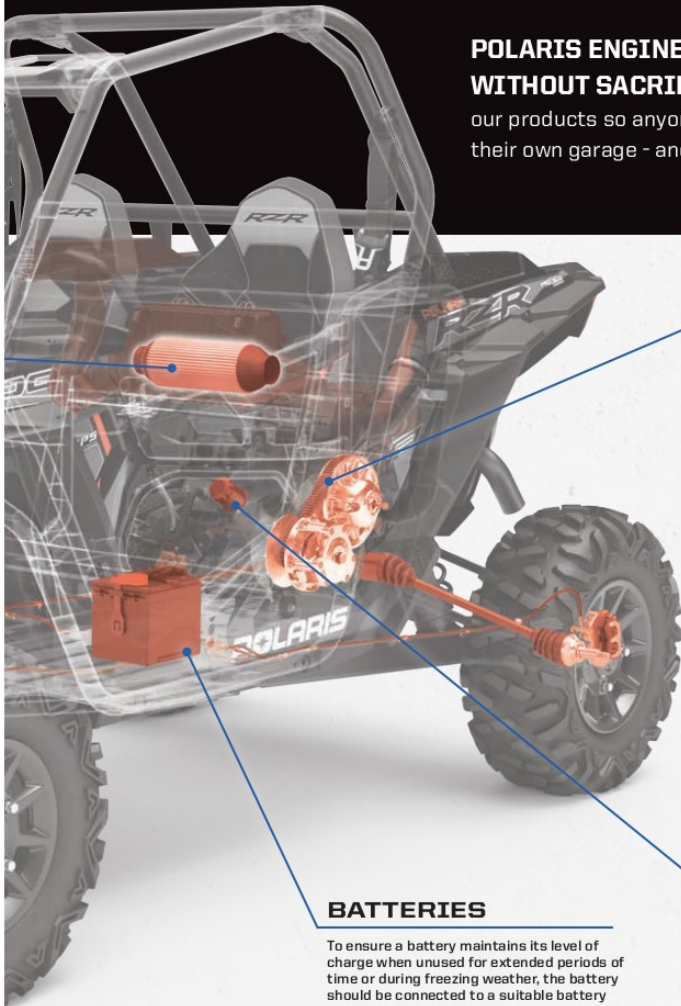

POLARIS ENGINEERS PARTS THAT PUSH THE LIMITS WITHOUT SACRIFICING STRENGTH AND DURABILITY. We build our products so anyone with the right tools can maintain their vehicle from their own garage - and get them back on the trails where they belong.

DRIVE BELTS

Polaris Engineered belts deliver unmatched performance for your off-road vehicle. Developed and tested on all our engines for all environments and conditions. Check your belt for delamination, hour glassing and glazing.

BREAK-IN PERIOD

- Use lower gear (if available) while varying speeds and avoiding wide open throttle for 8-16 km
- If no low gear is available, vary at moderate speeds while avoiding wide open throttle for 80 km

OUR INVESTMENT

- 32,187 km of field testing
- Thousands of dyno hours
- 18+ months of development (13,000+ design hours) per belt
- 1,500+ vehicle validation hours
- Collaboration with powertrain & clutch engineers

YOUR ADVANTAGE

- No clutch recalibration
- Less wear & tear due to heat
- Ensure maximum vehicle performance
- More time riding, less time wrenching
- Produced in collaboration with powertrain and clutch engineers to ensure a perfect fit, maximum performance and ultimate durability

BATTERIES

To ensure a battery maintains its level of charge when unused for extended periods of time or during freezing weather, the battery should be connected to a suitable battery charger. Consult your dealer to ensure the charger is compatible with your vehicle.

OIL FILTERS

Change oil filters with every oil change to provide the best engine protection and keep the engine operating at peak performance.

FOLLOW RECOMMENDED SERVICE INTERVALS IN THE OWNER'S MANUAL

200 HRS / 3200 km

24 MONTHS

- ENGINE OIL:** CHANGE
- SHOCK OIL & SEALS:** INSPECT, REPLACE AS NEEDED
- BRAKE PADS & FLUID:** REPLACE BRAKE FLUID
- SPARK PLUGS:** INSPECT, REPLACE AS NEEDED
- AIR FILTER:** INSPECT & REPLACE AS NEEDED
- EXHAUST SYSTEM:** INSPECT & CLEAN, INSPECT FOR LEAKAGE OR CARBON BUILD UP AT JOINTS, INSPECT & CLEAN SCREEN TYPE SPARK ARRESTOR

250 HRS / 4023 km

30 MONTHS

- ENGINE OIL:** CHANGE
- BATTERY:** TEST, CLEAN, & CHECK FLUID LEVEL, REPLACE AS NEEDED
- DRIVE BELT:** INSPECT & ADJUST, REPLACE AS NEEDED
- GENERAL LUBRICATION:** ALL FITTINGS, PIVOTS, CABLES, ETC.
- EXHAUST SYSTEM:** INSPECT & CLEAN, INSPECT FOR LEAKAGE OR CARBON BUILD UP AT JOINTS, INSPECT & CLEAN SCREEN TYPE SPARK ARRESTOR

300 HRS / 4828 km

36 MONTHS

- ENGINE OIL:** CHANGE
- AIR FILTER:** INSPECT & REPLACE AS NEEDED
- GEARCASE & TRANSMISSION:** REPLACE FLUIDS
- EXHAUST SYSTEM:** INSPECT & CLEAN, INSPECT FOR LEAKAGE OR CARBON BUILD UP AT JOINTS, INSPECT & CLEAN SCREEN TYPE SPARK ARRESTOR

CHECK YOUR OWNER'S MANUAL FOR ADDITIONAL RECOMMENDED SERVICE ITEMS AND VEHICLE-SPECIFIC TIMING



SPECIFIC NEEDS, *SPECIFIC OILS*

Polaris invests millions in engine development, and part of that investment is making sure its lubricants—critical to engine performance—are the right formula for your specific engine. The amount of testing data and engineering resources used in developing Polaris lubricants would overwhelm an aftermarket company. Therefore, the aftermarket must spec an oil to an industry-wide standard that must account for a variety of operating parameters.

PS-4 is designed specifically for Polaris 4-cycle engines and has high film strength and wear protection under extreme loads and temperatures. Exclusive anti-wear additives protect engine parts with extra rust and corrosion protection.

PS-4 SYNTHETIC PERFORMANCE OIL

• PS-4 is optimal for ambient operating temperatures of -40° C to 40° C

- › 1L • 502484
- › 4L • 502485
- › 25L • 502486
- › 60L • 502487
- › 200L • 502488

PS-4 OIL CHANGE KIT

• Contains the correct amount of oil for your vehicle and correct oil filter

- › 502541
SINGLE 570, TWIN 600, TWIN 700, TWIN 800
- › 502543
RANGER/RZR 900/1000
- › 502542
330500, SPORTSMAN 550/850/1000

PS-4 EXTREME-DUTY SYNTHETIC PERFORMANCE OIL

• PS-4 Extreme Duty is optimal for ambient operating temperatures of -20° C to 55° C

- › 1L • 502491
- › 4L • 502492
- › 25L • 502494
- › 60L • 502496
- › 200L • 502497

POLARIS

ENGINEERED PARTS
& LUBRICANTS

FOR THE LIFE OF YOUR RIDE ONLY THE BEST WILL DO

To create the best oil for any terrain, we invest in rigorous testing to ensure our oil delivers the consistency and performance you demand. The results are Polaris Engineered Lubricants that are tested and perfected to deliver excellent total engine protection for the life of your ride.

WHAT COUNTS IN OIL TESTING:

1. Does it protect the engine at high temperatures?
2. Does it keep the engine free from carbon and buildup?
3. Does the oil hold its viscosity over time?

ENGINE CHECKPOINTS

When evaluating an engine oil and its ability to protect and preserve the engine's power output and lifespan, Polaris engineers focus on key areas within the engine, some of the most critical ones include:

RING LANDS: Poor oxidative performance can lead to carbon and varnish buildup, which results in poor ring seal and loss of power, combustion blow by and fuel dilution of the oil.

PISTON RINGS: During the combustion process, extreme pressures are placed on the top ring, forcing it outward toward the cylinder wall, sealing the combustion chamber. With so much force applied, poor oil film strength between the top ring and the cylinder wall can lead to cylinder wear and loss of power.

ROD BEARINGS: Engine bearings ride on an extremely thin hydrodynamic film of oil. Poor oil film strength or using an oil with a thinner viscosity, can lead to premature bearing wear or even engine failure. Using an oil with high film strength and a strong viscosity, like PS-4 full synthetic, will extend the service life of your engine.

CAMSHAFT: Direct Acting Overhead Camshafts are used on many Polaris Prostar Engines. In this application the camshaft pushes directly on the valve, creating very high contact pressures compared to other camshaft configurations. These forces are so great that inferior oil can break down and be forced out of the contact area leading to increased wear. PS-4 full synthetic additives are specifically designed to provide wear protection against this.

OIL DEVELOPMENT

**12 DEDICATED
TEAM MEMBERS**

**FOCUSED ON
POLARIS OIL**

**18+
MONTHS**

**DEVELOPMENT
& TESTING**

**75,000+
HOURS**

**DYNO
TESTING**

**64,374
KILOMETERS**

**FIELD
TESTING**

ENGINEERED TO MAXIMIZE THE LIFE OF YOUR RIDE

All Polaris fluids—from anti-freeze to brake fluid—are developed for your vehicle. Trust the only fluids perfectly engineered for your needs.



DOT 4 BRAKE FLUID

Polaris DOT 4 Brake Fluid is a high-quality brake fluid designed for use in Polaris hydraulic brakes. Superior high-temp characteristics plus anti-corrosive additives extend the life of brake system components and provide consistent, positive braking.

- » 250 mL • 502526
- » 198 L • 502527



ANTI-FREEZE

Polaris Extended Life Coolant contains organic acid technologies to prevent corrosion on metal components, eliminate scaling, and maximize cooling system performance.

- » 1 L • 502566
- » 25 L • 502567
- » 206 L • 502568



AGL

A proprietary blend of additives designed to optimize Polaris' ORV transmission life. Extreme pressure additives protect gears, drive chain, and bearings from scoring and wear. Unlike typical gear case oils, AGL's unique viscosity range allows instant flow and film protection in extreme cold or high heat environments.

- » 1 L • 502505
- » 25 L • 502507
- » 200 L • 502508



DEMAND DRIVE FLUID

Engineered specifically for Polaris ORV front drive systems. Provides positive 4WD engagement in extreme cold or high heat conditions. Unique friction additives protect internal components under heavy loads and promote positive engagement.

- » 1 L • 502563
- » 25 L • 502564
- » 200 L • 502565

Proper lubricant application and timing will ensure optimal vehicle performance. Please refer to your owner's manual for lubricant change interval schedules.



CARBON CLEAN

Polaris Carbon Clean prevents ethanol corrosion, stabilizes fuel, and cleans fuel injectors, piston ring lands, intake systems, and combustion chambers. Helps maintain peak HP and improves fuel economy.

- » 125 mL • 502528



FUEL STABILIZER

Fuel Stabilizer prevents ethanol corrosion and stabilizes fuel for up to 2 years. Dual-antioxidant formula protects against gum and varnish for easy starting.

- » 125 mL • 502519



ANGLE DRIVE FLUID

» 1L • 502510
 » 25 L • 502511
 » 202 L • 502512
 SPORTSMAN, RANGER, RZR ANGLE DRIVE GEAR CASE SYSTEMS



PREMIUM GAS SHOCK OIL

- » 1L • 502518



ALL-SEASON GREASE TUBE

- » 400 g • 502538
- » 185 Kg • 502539

SERVICE PARTS

Polaris Engineered service parts deliver unmatched performance and fit for your off-road vehicle.

All service parts are engineered specifically for your machine. Which means everything is designed, tested and perfected to maximize the life of your ride. Getting Polaris Engineered parts is a decision that pays off in the long run, because it ensures there is a long run.



VISIT YOUR POLARIS DEALER TO SHOP FOR SERVICE PARTS.

OVER
100,000
PARTS
AVAILABLE!



FOR THE LIFE OF YOUR RIDE

Maintenance is the key to keeping your Polaris off-road vehicle performing at its peak. Items like belts, lubricants, and batteries represent only a few of these critical items engineered specifically by Polaris.



POLARIS ENGINEERED DRIVE BELTS

TESTED, PERFECTED

We test each belt on the intended vehicle - we don't just try to make an existing belt "just work".

- Amery Kuhl, Polaris CVT System Engineer

OUR INVESTMENT

- 32,187 km of field testing
- Thousands of dyno hours
- 18+ months of development (3,000+ design hours) per belt
- 1200+ vehicle validation hours
- Collaboration with powertrain & clutch engineers

YOUR ADVANTAGE

- No clutch recalibration
- Less wear & tear due to heat
- Ensure maximum performance of your vehicle
- More time out riding, less time wrenching

**OUR INVESTMENTS ENSURE POLARIS BELTS
OUTPERFORM YOUR EXPECTATIONS.**

HD HEAVY DUTY PARTS

All Polaris parts are developed and tested to help you get the most out of your ride. Now, we're taking the passion of our riders, workers, and outdoor enthusiasts to the next level with HD Parts.

Engineered & designed for:

- Greater durability
- Enhanced performance
- Greater wear & tear capabilities
- All weather conditions



NEW

WHEELS & TIRES

Class leading durability for off-road performance and traction for confident driving in extreme conditions.

- » 1524022-458 • HD WHEEL - 14x7 (SHOWN)
- » 5417507 • PRO ARMOR HD-K - 29x10R14 (SHOWN)
- » 5457498-458 • HD WHEEL CENTER CAP (SHOWN)
- » 5415756 • PRO ARMOR XD-K FRONT
- » 5415757 • PRO ARMOR XD-K REAR

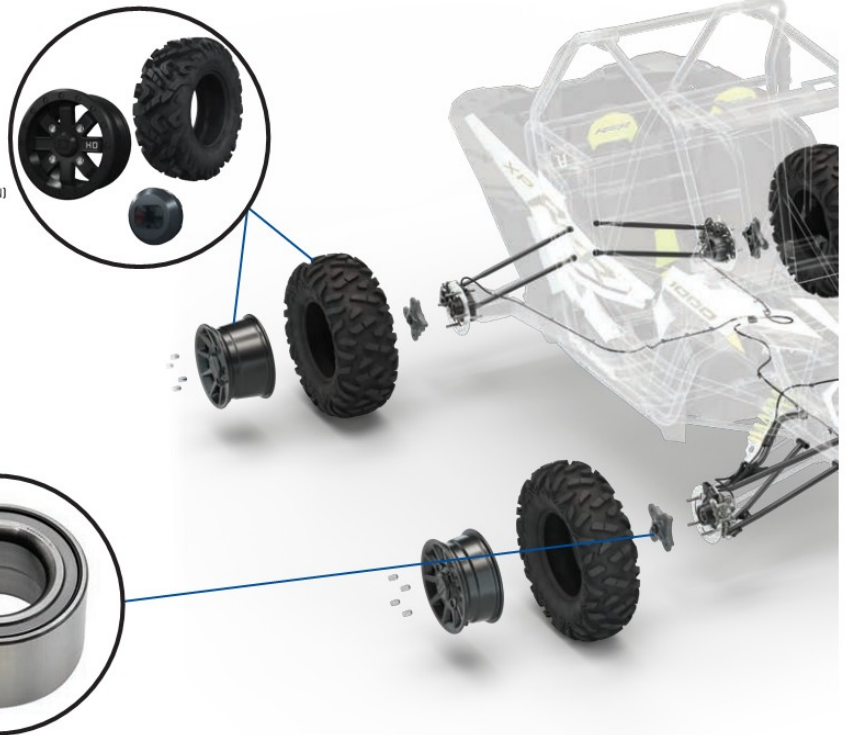

NEW

WHEEL BEARINGS

Fully sealed for added protection against intrusions. Made of a higher grade steel for extended life in extreme conditions.

LOCATION	OE	HD HEAVY DUTY PARTS
FRONT WHEEL BEARINGS	3514924	3515090
REAR WHEEL BEARINGS	3414924	3515090

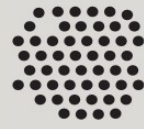

SAND



MUD



WATER



EXTREME COLD



EXTREME HEAT UP TO 54° C



HEAVY PAYLOADS



EXTENDED LIFE

PARTS & GARAGE

MAINTENANCE

OIL & LUBRICANTS

SERVICE PARTS

HD PARTS

VEHICLE CARE & TREATMENTS



NEW BUSHINGS

The advanced material compound of the bushings enables tighter tolerances to reduce overall wear on the system, while the superior triple lip sealing prevents intrusion of the elements.

LOCATION	OE	HD <small>HEAVY DUTY PARTS</small>
FRONT UPPER BUSHINGS	5439874	1543367
	5439730	
	5436973	1543326
FRONT LOWER BUSHINGS	5439874	1543367
	5439730	
	5436973	1543326
REAR UPPER BUSHINGS	5439874	1543367
	5439730	
	5436973	1543326
REAR LOWER BUSHINGS	5439874	1543367
	5439730	
	5436973	1543326
UPPER HUB BUSHINGS	5436832	1543367

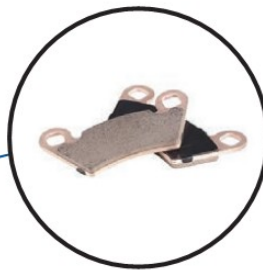

COMING SOON BRAKES

Engineered to provide longer life and better stopping power while riding in extreme conditions.

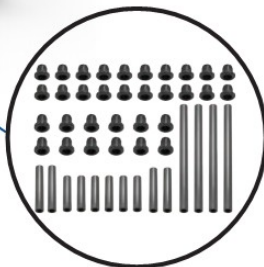

NEW BUSHING KITS

Easily update the entire front and rear suspension.

» 2830564
RZR 800 '08-'14, RZR 800 S '09-'14

For more information regarding Polaris HD parts including vehicle compatibility, installation, and maintenance, please contact your authorized Polaris ORV dealer.

CV BOOT REPAIR KIT

FIX ON THE GO | TEMPORARY COVERAGE

- A quick trail side fix to increase trail time
- The flexible and durable boot material expands over a cone tool for CV boot repairs, without disassembling CV axles
- Universal fit - works as a temporary fix for most powersports axles
- All components fit inside the cone, and a cover is provided for compact durable storage
- Easily fits in a cargo box, attached to the roll cage, in the glovebox, or many other storage locations



Items shown are contained inside cone

UTV CV BOOT REPAIR KIT

Kit includes the following items:

- (1) Expandable XL CV Boot
- (1) Reusable Cone Tool
- (2) CV Boot Clamps
- (1) Tube of Silicone Lube
- (1) Grease Packet
- (1) Cone Cover

» 2830526

UTV TRAIL BOOT ONLY

» 2830527

ATV

- » CV REPAIR KIT 2830528
- » TRAIL BOOT ONLY 2830529

HOW TO INSTALL

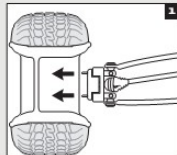

Remove wheel and axle nut.

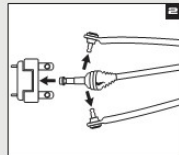

Remove brake caliper, hub, tie rod, & upper & lower ball joints.

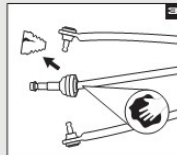

Remove old boot & clean joint.

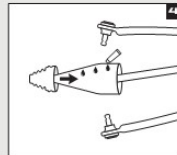

Spread silicone lube on entire cone tool. Slide boot over cone tool, large end first. See package for outer boot instructions.

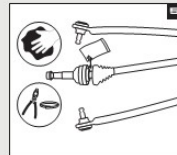

Empty the bag of grease into the CV joint/boot, clean sealing points & install clamps.

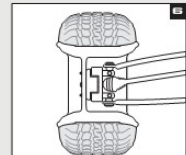

Reassemble tie rod, ball joints, brake caliper, axle nut, tire & wheel.

Refer to your service manual for further instructions and torque specifications.
*Designed for temporary CV boot repair. Purchase the OEM CV Boot for a permanent repair.

KEEP IT CLEAN

CLEAN

ALL-PURPOSE CLEANER

- Professional cleaner, which is formulated with a low pH-value. The product spreads well on surfaces and adheres on them for effective cleaning action. Perfectly compatible with rubber, plastic and painted surfaces. The formulation is biodegradable.

» 500 mL • 502309

SHINE

INSTANT SHINE & DETAILER

- The INSTANT SHINE AND DETAILER is developed for cleaning action without water. Removes insects, dust and dirt with almost no effort. Applicable for plastics, visors, windscreens, paint and metal. The wipe and shine formulation makes surfaces shine, works water repellent and also has an antistatic effect. Perfect for customers living in urban areas with no access to water, for bike trips or showroom bikes.

» 500 mL • 502303



BRING IT EVERYWHERE

TRAILERING



CALIBER RAMP PRO

- Designed for ATVs and UTVs up to 127 cm wide
- Integrated grip glides for ultimate traction
- Folding sides for easy transportation & storing

» 132 cm x 229 cm • 2884576



ALUMINUM ARCHED LOADING RAMPS

- » 193 cm x 30.5 cm • 907 kg • 2875384
- » 224 cm x 30.5 cm • 1361 kg • 2875386



LIGHTWEIGHT TRI-FOLD RAMPS

- Ramp folds up for transport
- Capacity for up to 681 kg
- Safety straps included

- » 183 cm x 130 cm • 2875385
- » 208 cm x 130 cm • 2875860

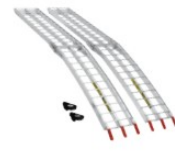

FOLDING ALUMINUM ARCHED RAMPS

- Ramp folds up for transport
- Capacity up to 1,361 kg
- Safety straps included

- » 224 cm x 30.5 cm • 2875387

HITCHES

3:1 HITCHES VERSATILE 3 IN 1 FUNCTIONALITY

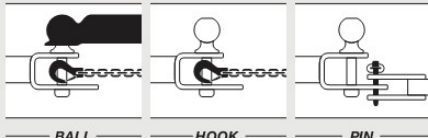

- Ball, pin and hook design
- Durable, rust resistant steel with black powdercoated finish

- Removable ball
- HD 1.6 cm pin and clip



HITCH WITH 5 cm BALL

- » 5 cm RECEIVER 2830522
- » 3 cm x 3 cm RECEIVER 2830523



4.8 cm BALL

- 4.8 cm replacement ball for hitch
- Designed to work with 3:1 Hitch



RECEIVER HITCH

- » 5 cm RECEIVER TONGUE 2875320
- » FRONT HITCH RECEIVER 2878846



TRAILER BALL 1.9 cm SHANK

- » 4.8 cm BALL • 2877602
- » 5 cm BALL • 2877603

STRAPS & ROPES



RECOVERY STRAP

- 5 cm x 9 m (8165 kg)
- Comes with carry bag

» 2884033



SPARE TIRE RATCHETING Y-STRAP

- » 2689506



RATCHET STRAP

- 5 cm x 6.1 m Ratchet Straps
- Heavy duty webbing, floating D-rings, double J-hooks
- 4536 kg maximum load, 1497 kg working load

» 2884032



RATCHET STRAP

- 3.8 cm x 4.6 m straps, 2 Pack
- Heavy duty webbing
- 2495 kg maximum load, 831 kg working load

» 2884031



SHOCK STRAP

- 3.8 cm 1361 kg breaking strength
- Keeps tension on tie-down straps to secure load
- 2 Pack
- » 3.8 cm x 4.6 m • 2883296



SHOCK STRAP

- 3.8 cm 1361 kg breaking strength
- Keeps tension on tie-down straps to secure load
- 2 Pack
- » 3.8 cm x 2.1 m • 2883295

AIR FILTER

PREMIUM FILTER KIT TOP SELLER

- Polaris Ultraweb high performance air filter
- Provides superior engine protection with 99.99% efficiency
- Superior dust-holding capacity
- Lower restriction offers better performance for high horsepower, torque, and acceleration

» 2882233

S 900 '15-20, S 4 1000 '19-20, S 1000 '16-20, 900 '14-20

» 2882234

TURBO S '18-21, XP TURBO '19-21, 4 TURBO S '20-21, XP 4 TURBO '19-21, XP 4 1000 '14-21, XP 1000 '14-21, PRO XP '21

COVERS

TRAILERABLE COVER BY POLARIS



» 4-SEAT • 2883989

PRO XP 4 '20-21

» 2-SEAT • 2883764

PRO XP 4 '20-21, PRO XP '20-21

» 2-SEAT • 2880327

S 900 '15-20, S 4 1000 '20, S 1000 '16-20, 900 '15-20

» 2-SEAT • 2880325

900 '14-20 SHOWN

» 2-SEAT • 2879373

XP TURBO '19-21, XP 4 TURBO '21, XP 4 1000 '21, XP 1000 '14-21

» 2-SEAT • 2876526

570 '12-21

» 4-SEAT • 2879949

TURBO S '21, XP TURBO '21, XP 4 TURBO '19-21, XP 4 1000 '14-21, S 4 1000 '19-20

» 2-SEAT • 2880326

S 4 1000 '19-20

> RIDING GEAR



OFF-ROAD RIDING JERSEYS S-3XL

- Mesh ventilated panels for maximum airflow
- Elastic sleeves with non-restrictive cuffs

OFF-ROAD RIDING GLOVES S-3XL

- Adjustable wrist closure for a custom fit
- Silicon finger grips and neoprene knuckle protection



BLACK
JERSEY | 2860646
GLOVE | 2860641

BLUE/LIME
JERSEY | 2860647
GLOVE | 2860642

MULTICOLOR
JERSEY | 2860648
GLOVE | 2860643

NAVY/PINK
JERSEY | 2860649
GLOVE | 2860644

RED
JERSEY | 2860650
GLOVE | 2860645

> COOLING SHIRTS



LONG SLEEVE

MEN'S | 2860638 S-3XL
WOMEN'S | 2860640 S-3XL

SHORT SLEEVE

MEN'S | 2860634 S-3XL
WOMEN'S | 2860636 S-3XL

> RAIN SUIT



RAIN JACKET
GRAY
S-3XL | 2869527

RAIN PANTS
GRAY
S-3XL | 2869528

- 100% waterproof lightweight and packable nylon
- YKK Zippers
- Rain jacket has removable hood

> TROY LEE DESIGNS



APPAREL & HELMETS

OUTWEAR & PROTECTION

MEN'S RZR

WOMEN'S RZR & YOUTH

LIFESTYLE & CAPS

CAMO & GIFTS



SE4 HELMET
XS-2XL
RED | 2861848
BLACK | 2861849



SNAPBACK HAT
One Size
BLACK | 2861857



PIT JACKET
S-2XL
RED | 2861852



FZ HOODIE
S-2XL
BLACK/RED | 2861853



GP JERSEY
S-2XL
BLACK | 2861850
WHITE | 2861851



LONG SLEEVE TEE
S-2XL
GRAY | 2861856



SHORT SLEEVE TEE
S-2XL
GRAY | 2861855
BLACK | 2861854

> HELMETS

FOR
POLARIS

RED/BLACK
XS-4XL
2861470



[ALTITUDE]



BLACK
XS-4XL
2861469



BLACK/RED
XS-4XL
2861472



CARBON FIBER
BLACK/LIME
XS-4XL | 2861473

NEW

509 ALTITUDE 2.0 HELMET

Lightweight Design, performance-infused style and features with all-day comfort

SHELL

- Strong, lightweight construction of carbon fiber or fiber glass

WEIGHT

- Composite as low as 1,260g
- Carbon fiber as low as 1,150g

FEATURES

- Superior fit for all-day comfort
- Removable Pro Series breath box provides excellent ventilation and air flow
- One-piece eye-port creates draft-free seal with 509 goggles
- Magnetic Fidlock chin-strap technology and integrated GoPro mount
- DOT- and ECE 22.05-approved

FIDLOCK®

> GOGGLES



BLACK
2868669



RED
2868670



LIME
2868671



BLUE
2868667

KINGPIN 509 DIRT GOGGLE



Premium Materials, attractive price

FEATURES

- Oversized spherical lens delivers optimal peripheral vision
- Metal tear off posts provide strength and durability
- Quick-change technology allows you to run the best lens tint for conditions



ORANGE
2868668



BLACK/LIME
XS-2XL
2861559

[TENACITY]



BLACK
XS-2XL
2861557



BLACK/GRAY
XS-2XL
2861558



BLACK/WHITE
XS-2XL
2861560



WHITE/RED
XS-2XL
2861561



PINK
XS-2XL
2861562

NEW

TENACITY 4.0 HELMET

Combination of modern style and premium protection with incredible value

SHELL

- Shock-resistant, injection-molded thermoplastic

WEIGHT

- 1,500g

FEATURES

- Through-flow, full-helmet ventilation
- ProClip quick release chin strap allows you to fasten the chin strap in seconds
- Removable breath box
- Tool-less adjustable roost shield
- Removable, washable liner
- DOT- and ECE 22.05-approved

TRAIL GOGGLE



Clear Vision at a Great Value

FEATURES

- Offers a distortion-free view with anti-scratch, anti-fog and UV-blocking technology
- Large lens opening enables greater peripheral vision



BLACK
2867917

> OUTERWEAR



FORCE JACKET

WINDBREAKER JACKET

NEW
FORCE JACKET

Versatile, lightweight jacket ideal for layering or wearing as a casual jacket.

MEN'S | S-3XL | 2861432



WOMEN'S
S-3XL | 2861433

NEW
WINDBREAKER JACKET

Lightweight, windproof jacket that provides protection while riding.

- 100% polyester windproof fabric
- 3 external pockets allow for maximum storage

S-3XL | 2861541



FLANNEL JACKET
BRONZE
S-3XL | 2860864

WORK JACKET
FOREST GREEN
S-3XL | 2860862

FLANNEL JACKET

This stylish flannel jacket is designed to keep you riding on brisk days. Soft yet durable brushed flannel with a Sherpa fleece lining offers excellent insulation without the bulkiness of a winter jacket.



CHARCOAL
S-3XL | 2860865

WORK JACKET

This warm and rugged jacket was engineered to be tough enough for work yet stylish enough for play.

External features:

- Constructed of Nylon 6, a durable, tear-resistant non-stretch woven fabric
- Coated with Durable Water Repellency (DWR) to provide water-resistance in the elements
- Four external pockets for maximum gear storage



NEW
BLACK
S-3XL | 2861608

GRAY
S-3XL | 2860863

Internal features:

- 80 gram 3M Thinsulate for added warmth
- Built in action back for increased range of motion
- Internal zipper pocket
- Brushed flannel trim



GRAY/BLUE
S-3XL | 2861439

BLACK
S-3XL | 2861434

NEW
SOFTSHELL JACKET

Lightweight performance that's surprisingly warm and perfect for everyday wear

- DWR prevents precipitation from saturating the jacket's exterior
- Three external and one internal pocket
- Lined with 280 grams of soft fleece for warmth
- Removable hood and underarm venting



MAROON
S-3XL | 2861438

BLACK
S-3XL | 2861437

GRAY
S-3XL | 2861435

BLACK/BLUE
S-3XL | 2861436

WOMEN'S

MEN'S



> **LAYERING**

TECH QUARTER ZIP
BLUE
S-3XL | 2861443

NEW
TECH QUARTER ZIP

Excellent for ride layering, comfortable and stylish stand-alone.

NORTHSTAR MID LAYER

Breathable fleece mid-layer is perfect for adding warmth or as a stand-alone shirt.

WOMEN'S

MEN'S



BLACK
S-3XL | 2861447

PINK
S-3XL | 2861448

BLACK
S-3XL | 2861442



NEW
BLACK/RED
S-3XL | 2861445

BLACK/GRAY
S-3XL | 2868925

**OUTERWEAR
BUILT TO
WORK HARD
& PLAY HARD**

> MEN'S RZR APPAREL

NEW

RZR TECH HOODIE
S-3XL
BLACK/RED | 2861544
GRAY/BLUE | 2861545



NEW

RZR LONG SLEEVE
S-3XL
ROYAL | 2861935
BLACK | 2861934

NEW

RZR TEE
S-3XL
BLACK/RED | 2861936
ROYAL | 2861937

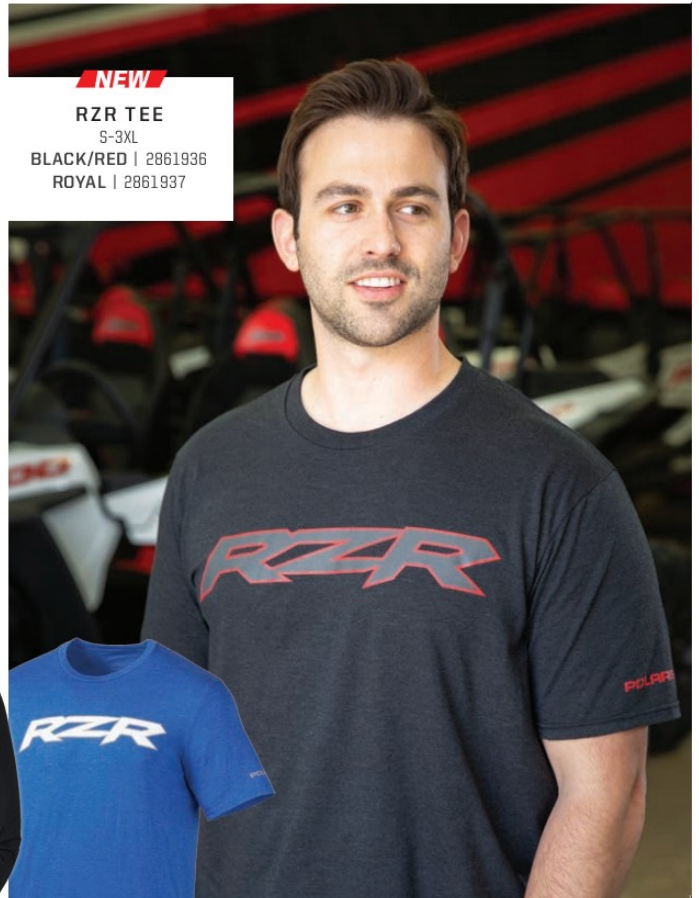



**RZR
FULL ZIP HOODIE**
S-3XL
BLACK | 2860719
CHARCOAL HEATHER | 2860720



**RZR
LOGO HOODIE**
S-3XL
GRAY/LIME | 2860704
BLACK/RED | 2869587
NAVY/ORANGE | 2869586



**RZR
VAPOR HOODIE**
S-3XL
GRAY | 2869593
RED | 2869594



RZR AIR TEE
S-3XL
BLACK | 2869591



RZR BOLT TEE
S-3XL
GRAY | 2860707
RED | 2860708



RZR EDGE TEE
S-3XL
BLACK | 2860729
NEW GRAY | 2861940



RZR SNAPBACK
One-Size
BLACK/RED | 2860611
BLACK/WHITE | 2860612



RZR PATCH HAT
NEW GRAY/BLUE | S/M | 2861547
NEW GRAY/BLUE | L/XL | 2861548
BLACK/RED | S/M | 2860607
BLACK/RED | L/XL | 2860608



NEW
RZR FLAT BILL
One-Size | NAVY | 2861546

> **WOMEN'S RZR APPAREL**



NEW
RZR TANK TOP
 S-3XL
 GRAY | 2861944
 BLACK | 2861945



RZR LIGHTWEIGHT HOODIE
 S-3XL
 SHADOW | 2860716
 MISTY BLUE | 2860717



RZR VAPOR HOODIE
 S-3XL
 CHARCOAL HEATHER | 2869595
 BLACK | 2860726
 MINT | 2869596



RZR SCENIC TEE
 S-3XL
 MARITIME | 2860715
 BLACK | 2860714
NEW GRAY | 2861943



RZR LOGO TEE
 S-3XL
 BLACK | 2860703
 NAVY | 2869583

> **YOUTH APPAREL**

APPAREL & HELMETS

OUTERWEAR & PROTECTION

MEN'S RZR

WOMEN'S RZR & YOUTH

LIFESTYLE & CAPS

CAMO & GIFTS



YOUTH RZR LOGO TEE
S-L
BLUE | 2860723
GRAY | 2860722

YOUTH RZR SCENIC TEE
S-XL
PURPLE | 2860724
SILK | 2860725



YOUTH JERSEY
S-XL
MULTICOLOR | 2860652
BLUE | 2860651



NEW
YOUTH ALL-IN TEE
S-XL
GRAY | 2861601
BLUE | 2861602



NEW
YOUTH ICON TEE
S-XL
GRAY | 2861603
MAROON | 2861604

> **LIFESTYLE**



NEW
MEN'S ICON HOODIE
 S-3XL
 BLACK | 2861496
 GREEN | 2861495



NEW
WOMEN'S TECH HOODIE
 S-3XL
 GRAY | 2861508
 MAROON | 2861509

NEW
MEN'S CREW SWEATSHIRT
 S-3XL
 GREEN | 2861498
 NAVY | 2861497



NEW
WOMEN'S ICON HOODIE
 S-3XL
 MAROON | 2861507
 BLACK/PINK | 2861506



NEW
MEN'S TECH HOODIE
 S-3XL
 BLACK/BLUE | 2861494
 GRAY | 2861493



NEW
WOMEN'S CHECKERED HOODIE
 S-3XL
 BLACK | 2861609
 BLUE | 2861610



> HATS & T-SHIRTS



NEW
MEN'S ALL-IN TEE
 S-3XL
 BLACK | 2861574
 GRAY | 2861575



NEW
BADGE TRUCKER HAT
 One-Size
 GRAY | 2861531
 NAVY | 2861532
 BLACK | 2861533
 PINK | 2861549
 MAROON | 2861537

NEW
TONAL HAT
 L/XL
 BLACK | 2861526
 NAVY | 2861525



NEW
CORE HAT
 One-Size
 NAVY | 2861523
 BLACK | 2861524

NEW
CHECKERED HAT
 One-Size
 NAVY | 2861520
 GRAY | 2861521
 BLACK | 2861522



NEW
WOMEN'S ALL-IN TEE
 S-3XL
 BLACK | 2861598
 OLIVE | 2861599



NEW
MEN'S PERFORMANCE LONG SLEEVE
 S-3XL
 ROYAL | 2861589
 GRAY | 2861588



NEW
MEN'S BACK GRAPHIC TEE
 S-3XL
 GRAY | 2861568
 NAVY | 2861569



NEW
MEN'S STAMP TEE
 S-3XL
 GRAY | 2861565
 GREEN | 2861564

APPAREL & HELMETS

OUTWEAR & PROTECTION

MEN'S RZR

WOMEN'S RZR & YOUTH

LIFESTYLE CAPS

CAMO & GIFTS

> CAMO

NEW

STEALTH CAMO HAT
One-Size
CAMO | 2861527



NEW

NORTHSTAR MID LAYER
S-3XL
CAMO | 2861542

NEW

CAMO SOFTSHELL JACKET
S-3XL
CAMO | 2861543



CAMO POLY HOODIE
S-3XL
BLACK | 2860718



HUNTER CAMO HOODIE
S-3XL
OLIVE | 2868716
GRAY | 2860728



CAMO FULL ZIP
S-3XL
OLIVE | 2869590



MEN'S CAMO TEE
S-3XL
GRAY | 2860709
BLACK | 2860710



CAMO HOODIE
S-3XL
WOMEN'S | 2867898
MEN'S | 2867879



CAMO TRUCKER HAT
One-Size
BLACK | 2860613
PINK | 2860614

> GIFTS & BRANDED MERCHANDISE

POLARIS STEEL SIGN
(26.7 cm x 61 cm)
2860868

PINT GLASS (SET OF 2)
2860815

POLARIS WOODEN COASTERS WITH BOTTLE OPENER
2860869

DRINKWARE



PREMIUM COOZIE
2860829



NEW
17oz WATER BOTTLE
2861611



NEW
12oz CAMPER MUG
2861612



NEW
15oz CAMPFIRE MUG
2861613

RECREATION/GARAGE



NEW
EVENT FOLDING CHAIR
2861617



NEW
FOLDING TABLE
2861620



POLARIS WOOD SIGN
(26.7 cm x 61 cm)
2860866



NEW
NECK GAITERS
One-Size
CAMO | 2861948
BLACK | 2861953
RZR SCENIC | 2861949
GRAY RZR TOPO | 2861951

COLLECTIBLES



NEW
KEYCHAIN
2861614



NEW
LEATHER KEYCHAIN
2861616



RZR FLAG (0.9 m x 1.5 m)
2869929



1:18 SCALE RZR TOY ORANGE
2868637



MINI RZR TOY BLUE
2860822

APPAREL & HELMETS

OUTWEAR & PROTECTION

MEN'S RZR

WOMEN'S RZR & YOUTH

LIFESTYLE & CAPS

CAMO & GIFTS



MAKE IT YOUR RZR

DUNES

LIGHTING	P. 48
RZR SUBZERO 4 HARNESS	P. 74
PRO ARMOR WHEELS & TIRES	P. 54
ROOFS	P. 26
DOORS	P. 27

MUD

PRO ARMOR WHEELS & TIRES	P. 54
WINCH & MIRRORS	P. 18
LOWER DOORS	P. 13
ROOFS	P. 12
LIGHTING	P. 15
AUDIO	P. 08
STORAGE / COOLERS	P. 16



ROCK

PRO ARMOR WHEELS & TIRES	P. 54
VEHICLE PROTECTION	P. 28
WINCH	P. 76
MIRRORS	P. 31
RIDE COMMAND	P. 50

Warning: Polaris off-road vehicles can be hazardous to operate and are not intended for on-road use. Driver must be at least 16 years old with a valid driver's license to operate. All riders should always wear helmets, eye protection and protective clothing and footwear. Read, understand and follow your owner's manual. Ride within the limits of your own abilities and never engage in stunt or exhibition driving. Never ride under the influence of drugs or alcohol. All riders should take a safety training course. Call 800-342-3764 for additional information.

UNLESS NOTED, TRADEMARKS ARE THE PROPERTY OF POLARIS INDUSTRIES INC. 3M® and Thinsulate® are registered trademarks of 3M Company. 505® is a registered trademark of Teton Outfitters, LLC. Apple® is a registered trademark of Apple Inc. App Store® is a registered trademark of Apple Inc. BatteryMinder® is a registered trademark of VDC Electronics Inc. Bluetooth® is a registered trademark of Bluetooth Sig, Inc. Caliber® is a registered trademark of Caliber, Inc. COOLCORE® is a registered trademark of COOLCORE LLC. CREP® is a registered trademark of Cre, Inc. Element Ready® is a trademark of Rockford Corporation. Fidlock® is a registered trademark of Fidlock GmbH. FOX® is a registered trademark of Fox Factory Inc. Google Play® is a registered trademark of Google, Inc. GoPro® is a registered trademark of GoPro Inc. High Lifter® is a registered trademark of High Lifter Products, Inc. KING OF THE HAMMERS® is a registered trademark of Hammering Productions, Inc. MB Quart® is a registered trademark of Maxxsonics USA Inc. Pandora® is a registered trademark of Pandora Media, LLC. Rigid® is a trademark of JST Performance, LLC d/b/a Rigid Industries. Rockford Fosgate® is a registered trademark of Rockford Corporation. ROHVA® and Recreational Off-Highway Vehicle Association® are registered trademarks of Recreational Off-Highway Vehicle Association. SBB® is a registered trademark of SBB Filters, Inc. Sparco® is a registered trademark of Sparco S.p.A. TEKVEST® is a registered trademark of 1181676 ONTARIO INC. The Mint 400® is a registered trademark of THE MINT 400 CORPORATION. Tiger Drylac® is a registered trademark of TIGER COATINGS GMBH & CO. KG. Troy Lee Designs® is a registered trademark of Troy Lee Designs, LLC. Yeti® is a registered trademark of Yeti Coolers, LLC. YKK® is a registered trademark of YKK Corporation. YouTube® is a registered trademark of Google Inc. Proline Wraps® is a registered trademark of Proline Wraps®. Prices, Fitment and Availability are subject to change at any moment. COPYRIGHT © 2020 POLARIS INDUSTRIES INC. ALL RIGHTS RESERVED.

Availability varies by market, check your local dealer for availability. Accessories and gear availability is subject to local regulations. Accessories are not available in all countries. Some gear shown may not be available for riding purposes but for casual use only. Please carefully read the instructions on the products or contact your local dealer for more information prior any use of the products. Polaris Industries Inc. reserves the right, without prior notice, to discontinue at any time at its discretion any of the items herein or change specifications or designs without incurring any obligation to the customer. All items are subject to availability and prior sales by our dealers.

RIDE OF YOUR LIFE



POLARIS

MY21 RZR APPACC EMEA