

EMEA VERSION

POLARIS SPORTSMAN

2021

ACCESSORIES + APPAREL



FORGE YOUR OWN PATH



Sportsman is legendary, giving you the ability to ride harder, go further and do more than any other ATV. From the farm yards to the scenic trails, the Polaris Sportsman line-up is chosen by more ATV owners than any other in the industry.

2021 LINEUP

NEW FOR MODEL YEAR 2021

P. 02

NEW GENERATION OF SPORTSMAN 570: P. 04

570

P. 14

RECREATION & UTILITY



SPORTSMAN 570 (EPS/EBS)

TOURING



SPORTSMAN TOURING 570 (EPS/EBS)

WORK



SPORTSMAN 570 6X6



SPORTSMAN 570 X2

SPECIAL EDITION



SPORTSMAN 570 AGRIC PRO



SPORTSMAN 570 HUNTER



SPORTSMAN 570 BLACK LE



SPORTSMAN 570 OHLINS



SPORTSMAN X2 570 NORDIC PRO

XP 1000 / XP 1000 S

P. 26

RECREATION & UTILITY



SPORTSMAN XP 1000



SPORTSMAN XP 1000 S

TOURING



SPORTSMAN TOURING XP 1000

SCRAMBLER

P. 34



SCRAMBLER XP 1000



SCRAMBLER XP 1000 S

YOUTH

P. 36



OUTLAW 70

CONTENTS

NEW FOR MODEL YEAR 2021 02

WINCHES 12

570 14

WINCHES, PROTECTION & RACKS 16

COMFORT, AUDIO & STORAGE 18

WINDSHIELDS 20

570 6X6, 570 TOURING & 570 X2 22

XP 1000 / XP 1000 S 26

WINCHES, RACKS & PROTECTION 28

COMFORT, AUDIO & STORAGE 30

WINDSHIELDS 32

SCRAMBLER 34

WINCHES, RACKS/STORAGE & PROTECTION 34

OUTLAW 70 YOUTH 36

COMMON ACCESSORIES 38

WHEELS & TIRES 38

TRACKS 44

GLACIER PLOW SYSTEMS 46

LIGHTING 48

HUNT 50

POLARIS NORTHSTAR COOLERS 52

PARTS & GARAGE 54

MAINTENANCE 54

OIL & LUBRICANTS 56

SERVICE PARTS 60

HD PARTS 58

VEHICLE CARE & TRAILERING 62

APPAREL & HELMETS 64

OUTERWEAR & PROTECTION 64

LIFESTYLE APPAREL & CAPS 70

CAMO & GIFTS 72

MODEL YEAR 2021

TAKE YOUR SPORTSMAN TO THE NEXT LEVEL



TRAIL

MOST POPULAR ADD-ONS

- Racks* P. 17
- Storage* P. 19
- Windshields* P. 20
- Wheels & Tires* P. 38

GO FURTHER

TAKE YOUR SPORTSMAN TO THE NEXT
LEVEL AND CONTINUE TO CUSTOMIZE
WITH THESE ACCESSORY ADD-ONS.



UTILITY

MOST POPULAR ADD-ONS

- Storage* P. 19
- Windshields* P. 20
- Winches* P. 12
- Wheels & Tires* P. 38

SPORTSMAN 450 AND 570 REBORN

WIDE SELECTION OF ACCESSORIES TO CHOOSE FROM TO
CUSTOMIZE YOUR EXPERIENCE

TRUE ON DEMAND
ALL-WHEEL DRIVE

BOLDER STYLE,
BIGGER VALUE

INDUSTRY-LEADING ACCESSORIES
ENGINEERED TO DO MORE
FOR EVERY KIND OF JOB BIG OR SMALL

SUPERIOR INTEGRATION

ESSENTIAL ACCESSORIES RIGHT FROM THE FACTORY TO MAKE WORK EASIER TO GET MORE DONE.

PRO PRO HEAVY DUTY SERIES
WINCHES

GLACIER
FLOW SYSTEM

Winches P. 12
Plows P. 46



ULTIMATE PROTECTION

VEHICLE AND RIDER PROTECTION AGAINST OBSTACLES ON THE TRAIL.

LOCK & RIDE

Protection P. 16
Windshields P. 20
Handguards P. 18



STORAGE VERSATILITY

VERSATILITY, ADDED STORAGE, AND LIMITLESS CUSTOMIZATION WITH EASY INSTALLATION.

LOCK & RIDE

Storage P. 19
Racks P. 17
Rack Extenders P. 17



POLARIS
ENGINEERED

DESIGNED



Designed by the same people who designed your vehicle.

TESTED



Extensively tested in the field so you ride with 100% confidence.

WE HOLD OUR PARTNERS TO THE SAME STANDARDS

PRO ARMOR 

WHEELS, TIRES & LIGHTING DESIGNED WITH POLARIS TO MAXIMIZE PERFORMANCE

P. 38, 48

KEEP YOUR STANDARDS HIGH. WE DO.

TRUSTED



65 years in the business.
The #1 name in Off-Road.



A GLOBAL LEADER IN AUDIO
INNOVATION, DESIGN & ENGINEERING

P. 19, 31



PRODUCTS SO GOOD THEY REPLACE
OR REPAIR THEM FOR LIFE

P. 48



MAKING PRODUCTS FOR AVID
SPORTSMEN SINCE 1943

P. 50

ENGINEERED



LOCK & RIDE

CARGO VERSATILITY

Lock & Ride mounting locations allow for limitless customization to let you work the way you want.

P. 19, 30

FOR MORE



Ensuring Polaris Engineered Accessories fit and work in sync with your machine is the most critical phase of testing and validation. With seamless integration, you can trust that any Polaris accessory you install will enhance your interaction beyond your expectations.

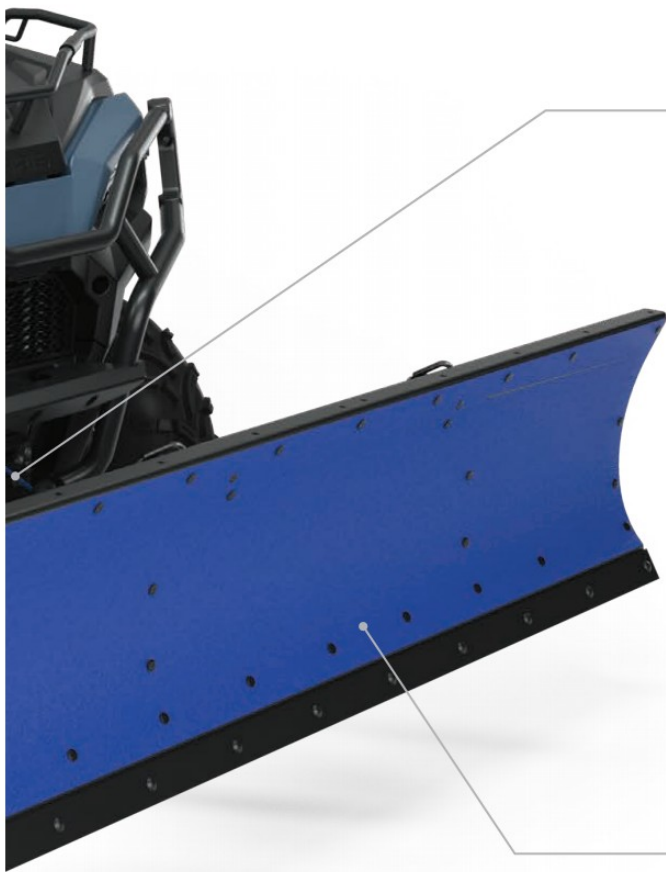

PRO PRO HEAVY DUTY SERIES

WINCHES

INTEGRATED WINCH MOUNT & PRE-WIRED

Designated mounting points and pre-wired connectors ensure a perfect fit and the strongest place to attach the Polaris Engineered winch - the most dependable winch for your Sportsman. With wiring built right into the vehicle, we made this the easiest Sportsman winch ever made to install.

P. 12

GLACIER PLOW SYSTEM

INTEGRATED PLOW MOUNT

The attachment points for the best-in-class Glacier Plow System are integrated right at the factory and feature an innovative drive-up and go installation process.

P. 46

SUPERIOR

INTEGRATION

PRO PRO HEAVY DUTY SERIES



I-HD HEAVY DUTY SERIES



WINCHES P. 12

WINCHES

POLARIS WINCH FEATURES



Tested **1,200+** pulls at max load, it works when you need it to



Built to withstand **-29°C** temperatures

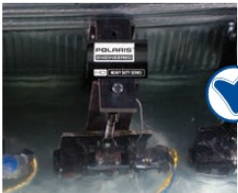

Sealed motor & heavy duty gears **OPERATE FULLY SUBMERGED UNDERWATER**



MILITARY tested & approved

PRE-WIRED CHASSIS

Factory-installed wiring makes the controls simple to install. Mount the winch, connect the wires and trust that everything is routed safely, securely, and properly.

NO NEED TO CUT PANELS

FULLY INTEGRATED MOUNT & WIRING

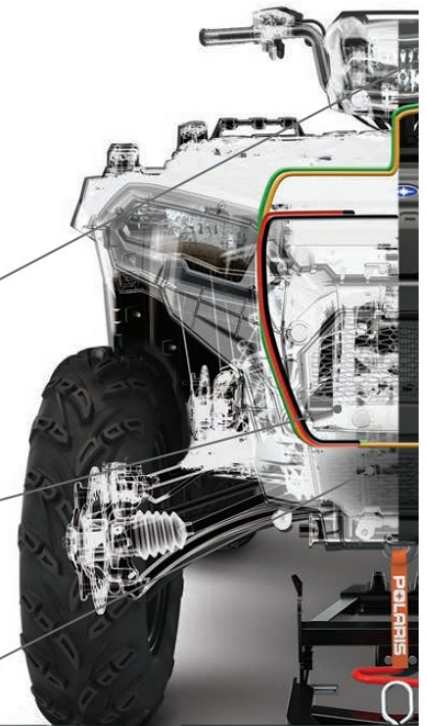

Right from the factory, your vehicle is built to make essential accessories like winches and plows easy to use day-in and day-out. Mounting brackets are designed into the oversized factory bumper and wiring is routed securely and properly. When it comes to Sportsman, Polaris Engineered Accessories make work easier so you can get more done.

POLARIS
ENGINEERED

GLACIER
PLOW SYSTEM

P. 46



PLOWS



GLACIER FEATURES

- ✓ Easily engage and disengage the plow system from your Polaris Sportsman
- ✓ No loss of factory ground clearance when not plowing
- ✓ Don't have to crawl under the machine to release the plow blade from the vehicle
- ✓ No trimming of vehicle plastic or fascia required to mount plow or winch

25°

LEFT AND RIGHT



ANGLE YOUR BLADE RIGHT
FROM YOUR SEAT



WINCHES

ADD A PLOW
P. 46

WHETHER HARD AT WORK OR ON THE TRAILS, ADD A WINCH TO...

- GET THE JOB DONE RIGHT
- GET YOU ON YOUR WAY FASTER
- BE PREPARED FOR UNEXPECTED SITUATIONS

WHY POLARIS?



TESTED **1,200+**
PULLS AT MAX LOAD



BUILT TO WITHSTAND
-29° C TEMPERATURES



OPERATES FULLY
SUBMERGED



MILITARY
TESTED & APPROVED

REPLACEMENT PART



REPLACEMENT STEEL CABLE

- 1588 kg Winch Series - 15.2 m
- » 2878890



RECOVERY STRAP

- 5cm x 9.1 m (8165 kg)
- Comes with carry bag
- » 2884033

FEATURES

ALL POLARIS ENGINEERED WINCHES COME WITH:



1. Set dial to FREE SPOOL (N) to attach winch hook
2. Set dial to PULL (L) for winch mode
3. Set dial to ROPE RECOVERY (H) for 5x faster rope recovery

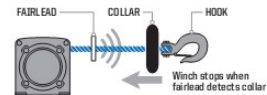

Stops winch at end of pull to prevent driveline stress and plow overlifting



- Lightweight & Easy to Handle
- Superior Flexibility & Strength
- 15 m Long



15 m range wireless remote control with unique code for interference-free operation

MODEL

450 H.O. '21
570 '21

450 H.O. '16-20
570 '14-20
X2 570 '15-21
TOURING 570 '14-21
6X6 570 '17-21

850 '12-21
XP 1000 '15-21
TOURING XP 1000 '15-21
TOURING 850 '15-21
SCRAMBLER 850 '14-21

XP 1000 S '20-21
SCRAMBLER XP 1000 S '20-21

PRO PRO HEAVY DUTY SERIES
TOP-OF-THE-LINE FEATURES



H-D HEAVY DUTY SERIES
BUILT FOR THE OFF-ROAD



PRO PRO HEAVY DUTY SERIES

H-D HEAVY DUTY SERIES

- ✓ INTEGRATED WIRING, MOUNT, PREASSEMBLED
- ✓ HOOK WITH STRAP
- ✓ CUT STEEL GEARS & SEALED DRIVETRAIN
- ✓ SEALED PERMANENT MAGNET MOTOR



NOT AVAILABLE



WITH ALUMINUM FAIRLEAD

ADD AUTO STOP TECHNOLOGY WINCH UPGRADE

2881693

SYNTHETIC ROPE REQUIRED



WITH STEEL ROLLER FAIRLEAD



ADD SYNTHETIC ROPE

TOP SELLER

2878888



ADD WIRELESS WINCH REMOTE

2879316



1588 kg
with Synthetic Rope

NEW
2884834

1588 kg
with Synthetic Rope

NEW
2884833

1134 kg
with Steel Cable

NEW
2884832

TOP SELLER
2880434

TOP SELLER
2880432

2882241

TOP SELLER
2880435

2880433

2883580

450 • 570

MAKE IT YOURS

COMFORT ESSENTIALS



<i>Pro HD 1,588 kg Winch</i>	<i>P. 16</i>	<i>Rear Brushguard</i>	<i>P. 16</i>	<i>Rigid D-Series Pro Driving LED Light</i>	<i>P. 48</i>
<i>Trail Brushguard</i>	<i>P. 16</i>	<i>Rear Rack Extender</i>	<i>P. 17</i>	<i>Rear Power Harness</i>	<i>P. 18</i>
<i>LED Light Kit</i>	<i>P. 18</i>	<i>Pro Armor Wheel & Tire Set: Dual Threat/Buckle Accent</i>	<i>P. 43</i>	<i>Handguards - Black</i>	<i>P. 18</i>
<i>Audio Storage Box</i>	<i>P. 19</i>	<i>Lug Nuts</i>	<i>P. 43</i>	<i>Handguard Mount</i>	<i>P. 18</i>
<i>Audio Storage Box Remote</i>	<i>P. 19</i>				

HUNTER



<i>Pro HD 1,588 kg Winch</i>	<i>P. 16</i>	<i>Gun Boot Mount</i>	<i>P. 50</i>	<i>Rear Power Harness</i>	<i>P. 18</i>
<i>HD Front Brushguard</i>	<i>P. 16</i>	<i>Mid Windshield</i>	<i>P. 20</i>	<i>Pro Armor Wheel & Tire Set: Mud XC/Sixr</i>	<i>P. 43</i>
<i>Rear Rack Extender</i>	<i>P. 17</i>	<i>Gun Boot</i>	<i>P. 50</i>	<i>Lug Nuts</i>	<i>P. 43</i>
<i>Hand & Thumb Warmer Kit</i>	<i>P. 18</i>	<i>Rigid SR-Series 25.4 cm Combo LED Light</i>	<i>P. 48</i>		

WORK HARD AND GET IT DONE with Polaris Engineered Accessories.
Find everything you need to outfit your trusted partner for the task at hand.



<i>1,134 kg Winch</i>	<i>P. 16</i>	<i>Rear Rack Extender</i>	<i>P. 17</i>	<i>Open Cargo Box</i>	<i>P. 19</i>
<i>HD Front Brushguard</i>	<i>P. 16</i>	<i>Pro Armor Wheel & Tire Set: Harvester/Shackle - Matte Black</i>	<i>P. 43</i>	<i>Front Utility Rack</i>	<i>P. 17</i>
<i>Body Armor</i>	<i>P. 17</i>	<i>Lug Nuts</i>	<i>P. 43</i>	<i>Rear Utility Rack</i>	<i>P. 17</i>
<i>Rear Brushguard</i>	<i>P. 16</i>	<i>Mid Windshield</i>	<i>P. 20</i>		



<i>Pro HD 1,588 kg Winch</i>	<i>P. 16</i>	<i>Hand & Thumb Warmer Kit</i>	<i>P. 18</i>	<i>Rear Power Harness</i>	<i>P. 18</i>
<i>Glacier Integrated Plow Mount</i>	<i>P. 47</i>	<i>Windshield - Tall</i>	<i>P. 20</i>	<i>HD Front Brushguard</i>	<i>P. 16</i>
<i>Glacier Pro Lock & Ride Steel ATV Plow Frame, Black</i>	<i>P. 47</i>	<i>Rear Rack Extender</i>	<i>P. 17</i>	<i>Rear Cargo Box</i>	<i>P. 19</i>
<i>Glacier Pro Plow Blade - 167.6 cm Poly</i>	<i>P. 47</i>	<i>Rigid SR-Series 25.4 cm Combo LED Light</i>	<i>P. 48</i>		

ACCESSORIES

WINCHES

450-570

850-XP1000-
XP1000S

SCRAMBLER
850-XP1000S

MISC. & YOUTH

WHEELS & TIRES

TRACKS & PLOW

LIGHTING

HUNT & COOLERS

2021 SPORTSMAN 450 • 570



WINCHES

NEW POLARIS PRO HD 1,588 kg WINCH

- Adds 1,588 kg of pulling capacity with auto stop technology for plowing applications
- New rapid rope recovery design with standard pulling mode and high-speed recovery which recovers open cable 5 times faster than standard speeds with quick and easy installation

» 2884834
570 '21, 450 H.O. '21



INDUSTRY 1ST TECHNOLOGY

RAPID ROPE RECOVERY



LEARN MORE ON P. 12

NEW POLARIS HD 1,588 kg WINCH

- Adds 1,588 kg of pulling capacity with a quick and easy installation
- Includes all components required for installation plus 50' of 3/16 premium high-strength synthetic rope

» 2884833
570 '21, 450 H.O. '21



NEW POLARIS HD 1,134 kg WINCH

- Adds 1,134 kg of pulling capacity with quick and easy installation
- Includes all components required for installation plus 50' of 3/16 high-strength steel cable

» 2884832
570 '21, 450 H.O. '21



PROTECTION

NEW TRAIL BRUSHGUARD

- Provides enhanced protection from brush and debris
- Has designated light bar holes and is compatible with winch and body armor

» 2884844
570 '21, 450 H.O. '21



NEW REAR BRUSHGUARD

- Protect your vehicle from brush, sticks, rocks and light bumps into solid objects
- Made of sturdy 3.2 cm Steel Tube with a matte black finish

» 2884847
570 '21, 450 H.O. '21



NEW HD FRONT BRUSHGUARD WITH HITCH

- Adds heavy duty protection with a custom lock
- Has designated light bar holes and is compatible with winch and body armor
- Standard front receiver hitch for additional functionality

» 2884850
570 '21, 450 H.O. '21



NEED A PLOW? SEE P. 46



RACKS



NEW BODY ARMOR – BLACK

- Provides extra protection to your ATV's full body and fenders
- » 2884851
570 '21, 450 H.O. '21
Front bumper (2884850 or 2884844) required for installation

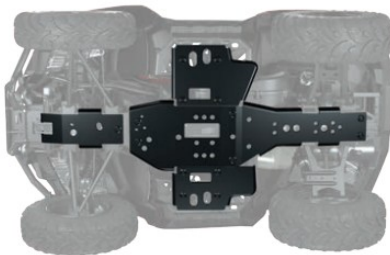

NEW SKID PLATE

- Built to be tough from 10mm thick high-density polyethylene
- » 2884852
570 '21, 450 H.O. '21



NEW FRONT RACK EXTENDER

- Forms a 7.6 cm tall perimeter around the front cargo rack to keep gear secure which maximizes your cargo capabilities
 - Durable steel construction provides a sturdy tie down anchor for loose gear
- » 2884840
570 '21, 450 H.O. '21



NEW REAR RACK EXTENDER

- Forms a 7.6 cm tall perimeter around the rear cargo rack to keep gear secure which maximizes your cargo capabilities
 - Durable steel construction provides a sturdy tie down anchor for loose gear
 - Compatible with Cargo Boxes and Rear Utility Rack
- » 2884841
570 '21, 450 H.O. '21



NEW FRONT UTILITY RACK

- Tubular steel rack that attaches on top of front plastic rack providing protection and multiple tie down points
 - 1.9 cm diameter matte black tube steel
- » 2884842
570 '21, 450 H.O. '21



NEW REAR UTILITY RACK

- Replaces rear plastic rack with a strong flat steel rack with integrated tie down points
 - Works with all Lock & Ride accessories, rack extenders, and gun mounts
- » 2884843
570 '21, 450 H.O. '21

2021 SPORTSMAN 450 • 570



COMFORT



NEW HAND & THUMB WARMER KIT

- Provides heat to grips and throttle and is easily installed by plugging into pod
 - Includes two heated grips and one throttle warmer
- » 2885002
570 '21, 450 H.O. '21



NEW REAR POWER HARNESS

- Provides power to the rear of the ATV for electrical accessories including Rear Audio Storage Box
- » 2889070
570 '21, 450 H.O. '21



HANDGUARDS

■ BRIGHT WHITE	2876883
■ BLACK	2876846
■ INDY RED	2876845

- Handguard Mount (2879380) is required when installing Polaris Handguards
 - Does not fit with windshields or handlebar-mounted mirrors
- » 2879380 • MOUNT **TOP SELLER**
570 '21, 450 H.O. '21



HANDLEBAR MOUNTED MIRRORS **TOP SELLER**

- For added safety on or off the trail
 - Sold as a pair
 - Does not fit with windshield fairing or handguards
- » 2877222
570 '21, 450 H.O. '21



NEW LED LIGHT KIT

- Upgrade your standard headlights and pod lights to LEDs with this upgrade kit
- » 2884859
570 '21, 450 H.O. '21



AUDIO

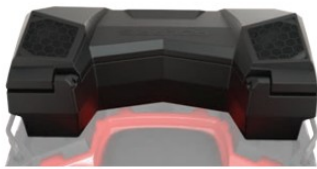

NEW **FULL AVAILABILITY**

REAR AUDIO STORAGE BOX **LOCK & RIDE**

- Dual 15.2 cm Speakers by Rockford Fosgate that connect via Bluetooth
- Mounts easily with Lock & Ride to the rear rack and is compatible with rack extenders, utility rack, and gun mount
- Rest easy knowing that your speakers are protected with a sealed lid container
- Rear power harness required for installation (2889070)

» 2884856
570 '21, 450 H.O. '21



NEW **AUDIO STORAGE BOX REMOTE**

- Easily control the volume or switch to the next song on your Rear Audio Storage Box that conveniently mounts to your ATV's handlebars

» 2884987
570 '21, 450 H.O. '21

STORAGE

NEW **REAR CARGO BOX** **LOCK & RIDE**

- Increase your storage with an extra 80.4 liters of dry, dust-proof storage
- Mounts easily with Lock & Ride to the rear rack and is compatible with rack extenders, utility rack, and gun mount
- Includes 2 padlock locations

» 2884853
570 '21, 450 H.O. '21



NEW **OPEN CARGO BOX** **LOCK & RIDE**

- Increase your storage with an extra 83.3 liters of convenient storage space
- Mounts easily with Lock & Ride to the rear rack and is compatible with rack extenders, utility rack, and gun mount
- Holds 2, 18.9-liter buckets with integrated grab handle to make it easy to carry and transport cargo
- 12 convenient tie-down locations to secure cargo

» 2884854
570 '21, 450 H.O. '21



NEW **REAR COOLER BOX** **LOCK & RIDE**

- Increase your storage with an extra 46 quarts of weather resistant cooler storage
- Mounts easily with Lock & Ride to the rear rack and is compatible with rack extenders, utility rack, and gun mount
- Integrated bottle opener and 2 padlock locations

» 2884857
570 '21, 450 H.O. '21



2021 SPORTSMAN 450 • 570



WINDSHIELDS



Tall 48.9 cm Clear



Mid 39.4 cm Clear



Short 24.1 cm Clear

NEW

LOOK & RIDE SPORTSMAN WINDSHIELDS

- Lock & Ride technology allows for easy installation and removal in seconds without tools
- Lock & Ride mounts allow a rider to adjust the height and angle of the windshield
- Poly windshields are flexible, impact-resistant, and provide long-term value over the life of your machine
- Three heights available for whatever coverage you prefer
- Does not work with handguards

SIZE	COLOR	PART #
TALL 48.9 cm	CLEAR	2884945
MID 39.4 cm	CLEAR	2884845
SHORT 24.1 cm	CLEAR	2884946

570 '21, 450 H.O. '21





DO MORE

LIGHTING SEE P. 48



HUNT SEE P. 50



PLOWS SEE P. 46



WHEELS & TIRES SEE P. 38



2014-2021 SPORTSMAN 570 6X6 570 TOURING 570 X2



WINCHES

POLARIS HD 1,588 kg WINCH TOP SELLER

» 2880434
X2 570 '15-21, TOURING 570 '14-21,
6X6 570 '17-21



POLARIS HD 1,134 kg WINCH

» 2880432
X2 570 '15-21, TOURING 570 '14-21,
6X6 570 '17-21



NEED A PLOW? SEE P. 46

STORAGE

SEMI-RIGID TOURING CARGO BAG

- Large-capacity, heavy-duty vinyl bag
- Three zippered openings, removable dividers
- Attaches to rack with Velcro straps

» 2877220
TOURING 570 '14-21



FENDER BAG

- Ideal for holding items you want to keep close at hand such as glasses, gloves, or water bottles
- Easy to access contents while seated

» 2876604
X2 570 '15-21, TOURING 570 '14-21, 6X6 570 '17-21



COMFORT



HAND WARMERS TOP SELLER

» 2877363

X2 570 '15-21, TOURING 570 '14-21, 6X6 570 '17-21

HANDGUARDS

- BRIGHT WHITE 2876883
- BLACK 2876846
- INDY RED 2876845

- Handguard Mount (2879380) is required when installing Polaris Handguards
- Does not fit with windshields or handlebar-mounted mirrors

» 2879380 • MOUNT TOP SELLER

X2 570 '15-21, TOURING 570 '14-21, 6X6 570 '17-21



THROTTLE/THUMB WARMER TOP SELLER

» 2877364

X2 570 '15-21, TOURING 570 '14-21, 6X6 570 '17-21



HANDLEBAR MOUNTED MIRRORS TOP SELLER

- For added safety on or off the trail
- Sold as a pair
- Does not fit with windshield fairing or handguards

» 287222

X2 570 '15-21, TOURING 570 '14-21, 6X6 570 '17-21

PROTECTION, RACKS & WINDSHIELDS



FRONT BRUSHGUARD TOP SELLER

» 2879714

X2 570 '15-21, TOURING 570 '14-21, 6X6 570 '17-21



REAR BRUSHGUARD TOP SELLER

» 2879715

TOURING 570 '14-21

ULTIMATE SERIES – RACK EXTENDER 10.2 cm



FRONT TOP SELLER

» 2879716

X2 570 '15-21, TOURING 570 '14-21, 6X6 570 '17-21



LOCK & RIDE

YUKON ADVENTURE RACK

- Adds increased storage volume by allowing you to increase storage height securely

» 2882084

6X6 570 '17-21

LOCK & RIDE SPORTSMAN WINDSHIELDS TOP SELLER

- Windshield installs/removes in seconds without tools
- Lock & Ride mounts allow adjustment of height and angle
- Poly windshields are flexible, impact-resistant, and provide long-term value over the life of your machine
- Does not work with handguards

SIZE	COLOR	PART #
TALL 48.9 cm	CLEAR	2880539-409
MID 39.4 cm	SMOKE	2880540-412

X2 570 '18-21, TOURING 570 '18-21



Tall 48.9 cm Clear



Mid 39.4 cm Smoke

2014-2020 SPORTSMAN 450 • 570

WINCHES

**POLARIS HD
1,588 kg WINCH**

TOP SELLER

» 2880434

570 '14-20, 450 H.O. '16-20



**POLARIS HD
1,134 kg WINCH**

TOP SELLER

» 2880432

570 '14-20, 450 H.O. '16-20



NEED A PLOW? SEE P. 46

PROTECTION



FRONT BRUSHGUARD

TOP SELLER

» 2879714

570 '14-20, 450 H.O. '16-20



REAR BRUSHGUARD

TOP SELLER

» 2879715

570 '14-20, 450 H.O. '16-20

RACKS

ULTIMATE SERIES – RACK EXTENDER 10.2 cm



FRONT

TOP SELLER

» 2879716

570 '14-20, 450 H.O. '16-20



REAR

TOP SELLER

» 2879717

570 '14-20, 450 H.O. '16-20

STORAGE



LOCK & RIDE REAR CARGO BOX

TOP SELLER

- Increase your storage with an extra of capacity
- Store two full-size helmets
- Works with Rack Extenders
- Will not fit when Utility Rack is installed

» 2882882

570 '14-20, 450 H.O. '12-20



COMFORT



HAND WARMERS TOP SELLER

» 2877363
570 '14-20, 450 H.O. '12-20



THROTTLE/THUMB WARMER TOP SELLER

» 2877364
570 '14-20, 450 H.O. '12-20



HANDGUARDS

- BRIGHT WHITE 2876883
- BLACK 2876846
- INDY RED 2876845

- Handguard Mount (2879380) is required when installing Polaris Handguards
- Does not fit with windshields or handlebar-mounted mirrors

» 2879380 • MOUNT TOP SELLER
570 '14-20, 450 H.O. '12-20



HANDLEBAR MOUNTED MIRRORS TOP SELLER

- For added safety on or off the trail
- Sold as a pair
- Does not fit with windshield fairing or handguards

» 2877222
570 '14-20, 450 H.O. '12-20

WINDSHIELDS



Tall 48.9 cm Clear



Mid 39.4 cm Smoke

LOCK & RIDE SPORTSMAN WINDSHIELDS TOP SELLER

- Windshield installs/removes in seconds without tools
- Lock & Ride mounts allow adjustment of height and angle
- Poly windshields are flexible, impact-resistant, and provide long-term value over the life of your machine
- Does not fit with handguards

SIZE	COLOR	PART #
TALL 48.9 cm	CLEAR	2880539-409
MID 39.4 cm	SMOKE	2880540-412

570 '18-20, 450 H.O. '18-20

850 • XP 1000 • XP 1000 S **MAKE IT YOURS**

COMFORT ESSENTIALS



<i>Winches</i>	<i>P. 28</i>	<i>Storage</i>	<i>P. 30</i>
<i>Protection</i>	<i>P. 29</i>	<i>Lighting</i>	<i>P. 48</i>
<i>Racks/Rack Extenders</i>	<i>P. 28</i>	<i>Wheels & Tires</i>	<i>P. 38</i>
<i>Windshields</i>	<i>P. 32</i>		

HUNTER



<i>Winches</i>	<i>P. 28</i>	<i>Hunting Accessories</i>	<i>P. 50</i>
<i>Protection</i>	<i>P. 29</i>	<i>Lighting</i>	<i>P. 48</i>
<i>Racks/Rack Extenders</i>	<i>P. 28</i>	<i>Wheels & Tires</i>	<i>P. 38</i>
<i>Windshields</i>	<i>P. 32</i>		

WORK HARD AND GET IT DONE with Polaris Engineered Accessories.
Find everything you need to outfit your trusted partner for the task at hand.

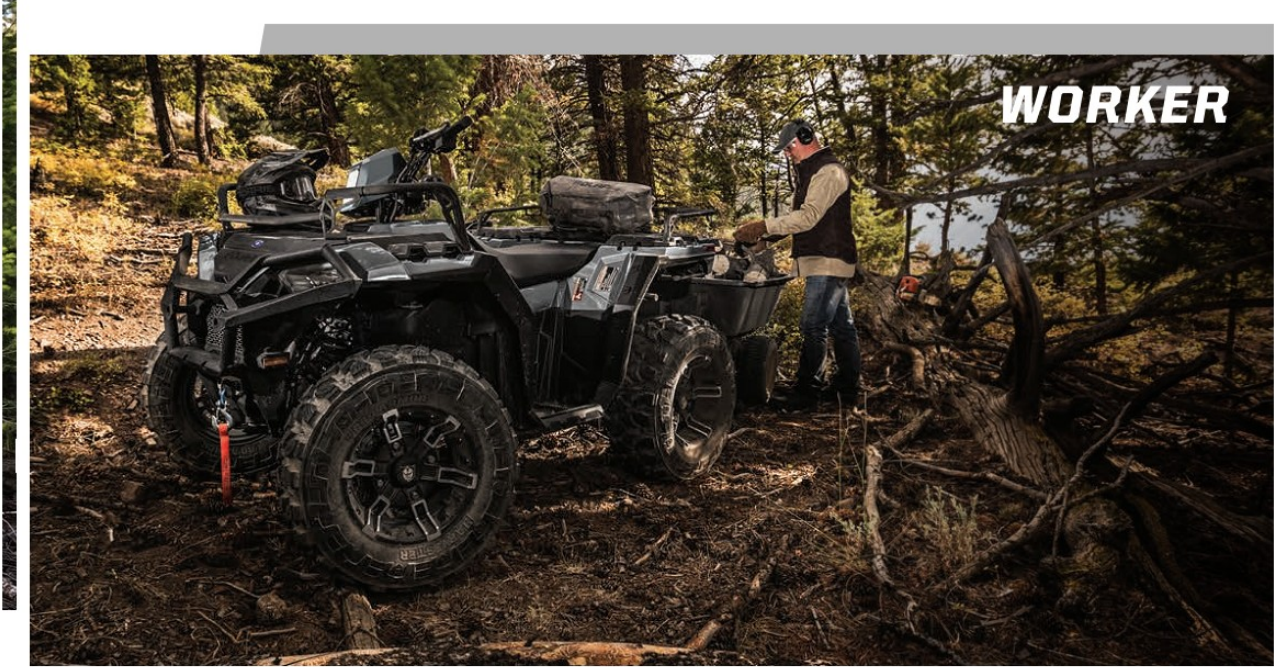

ACCESSORIES

WINCHES

450-570

850-XP1000-
XP1000S

SCRAMBLER
850-XP1000S

MISC. & YOUTH

WHEELS & TIRES

TRACKS & PLOW

LIGHTING

HUNT & COOLERS

<i>Winches</i>	<i>P. 28</i>	<i>Storage</i>	<i>P. 30</i>
<i>Protection</i>	<i>P. 29</i>	<i>Lighting</i>	<i>P. 48</i>
<i>Racks/Rack Extenders</i>	<i>P. 28</i>	<i>Wheels & Tires</i>	<i>P. 38</i>
<i>Windshields</i>	<i>P. 32</i>		



<i>Winches</i>	<i>P. 28</i>	<i>Plow System</i>	<i>P. 46</i>
<i>Protection</i>	<i>P. 29</i>	<i>Lighting</i>	<i>P. 48</i>
<i>Rack Extenders</i>	<i>P. 29</i>	<i>Wheels & Tires</i>	<i>P. 38</i>
<i>Windshields</i>	<i>P. 32</i>		

SPORTSMAN 850 XP 1000 XP 1000 S



WINCHES

POLARIS PRO HD 1,588 kg WINCH

- » 2883580
XP 1000 S '20-21
- » 2882241
XP 1000 '15-21, TOURING XP 1000 '15-21,
TOURING 850 '12-21, 850 '12-21



INDUSTRY 1ST TECHNOLOGY

RAPID ROPE RECOVERY

5X
FASTER

LEARN MORE ON P. 12

POLARIS HD 1,588 kg WINCH TOP SELLER

- » 2880435
XP 1000 '15-21, TOURING XP 1000 '15-21,
TOURING 850 '12-21, 850 '12-21



POLARIS HD 1,134 kg WINCH

- » 2880433
XP 1000 '15-21, TOURING XP 1000 '15-21,
TOURING 850 '12-21, 850 '12-21



NEED A PLOW? SEE P. 46

RACKS

ULTIMATE SERIES – RACK EXTENDER 10.2 cm

FRONT

- » 2882022
XP 1000 S '20-21, XP 1000 '17-21,
850 '17-21

REAR

- » 2882023
XP 1000 S '20-21, XP 1000 '17-21,
850 '17-21
Fits with Rear Cargo Box (2882882)



ULTIMATE SERIES – RACK EXTENDER 17.8 cm

FRONT

- » 2882024
XP 1000 S '20-21, XP 1000 '17-21, 850 '17-21

REAR

- » 2882025
XP 1000 S '20-21, XP 1000 '17-21, 850 '17-21
Does not fit with Rear Cargo Box (2882882)



FRONT RACK EXTENDER

- » 2879890
TOURING XP 1000 '15-21, TOURING 850 '21
Does not fit with Front Cargo Box installed



PROTECTION

ULTIMATE SERIES – STEEL RACK

FRONT

» 2883257
XP 1000 S '20-21, XP 1000 '17-21,
850 '17-21

REAR

» 2883258
XP 1000 S '20-21, XP 1000 '17-21,
850 '17-21



FRONT



REAR

ULTIMATE SERIES –
MOVEABLE
TIE-DOWN POINTS

» 2882270
(FRONT & REAR - SOLD IN PAIRS)
XP 1000 '17-21, 850 '17-21

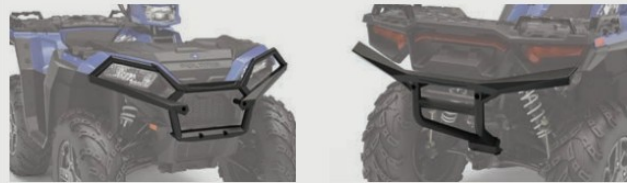

SPORTSMAN ULTIMATE SERIES – BRUSHGUARD

- Quick installation to the integrated mounting tubes on the vehicle using wedge-style expansion anchor mounts
- Attach the Body Armor to the Front Brushguard to provide the ultimate protection for the front fenders

» 2882020 • FRONT **TOP SELLER**
XP 1000 S '20-21, XP 1000 '17-21, 850 '17-21

» 2882583 • REAR
XP 1000 '17-21, 850 '17-21



SPORTSMAN
ULTIMATE SERIES
– BODY ARMOR

- Securely mounts to Ultimate Series Sportsman XP Front Brushguard (2882020)
 - Comes as pair
- » 2882090
XP 1000 '17-21, 850 '17-21



SPORTSMAN TOURING XP BRUSHGUARD

- Adds heavy-duty protection and a custom look

» 2878709 • FRONT
TOURING XP 1000 '15-21, TOURING 850 '10-21

» 2878324 • REAR
TOURING XP 1000 '15-21,
TOURING 850 '10-21

SPORTSMAN 850 XP 1000 XP 1000 S



STORAGE



NEW REAR CARGO BOX LOCK & RIDE

- Increase your storage with an extra 80.4 liters of dry, dust-proof storage
- Mounts easily with Lock & Ride to the rear rack and is compatible with rack extenders and gun mount
- Includes 2 padlock locations
- Will not fit when Ultimate Series Steel Rack is installed

» 2884853
XP 1000 S '20-21, XP 1000 '17-21, 850 '17-21



ULTIMATE SERIES – READY PACK

- Keep your trail essentials at the ready with this easy-to-access, weather-resistant storage compartment

» 2882271
XP 1000 '17-21, 850 '17-21



NEW OPEN CARGO BOX LOCK & RIDE

- Increase your storage with an extra 83.3 liters of convenient storage space
- Mounts easily with Lock & Ride to the rear rack and is compatible with rack extenders and gun mount
- Holds 2, 18.9-liter buckets with integrated grab handle to make it easy to carry and transport cargo
- 12 convenient tie-down locations to secure cargo
- Includes 2 padlock locations
- Will not fit when Ultimate Series Steel Rack is installed

» 2884854
XP 1000 S '20-21, XP 1000 '17-21, 850 '17-21



FRONT CARGO BOX LOCK & RIDE

» 2877951
TOURING XP 1000 '15-21, TOURING 850 '10-21
The Front Rack Extender cannot be installed at the same time as the storage box



NEW REAR COOLER BOX LOCK & RIDE

- Increase your storage with an extra 46 quarts of weather resistant cooler storage space
- Mounts easily with Lock & Ride to the rear rack and is compatible with rack extenders and gun mount
- Integrated bottle opener and 2 padlock locations
- Will not fit when Ultimate Series Steel Rack is installed

» 2884857
XP 1000 S '20-21, XP 1000 '17-21, 850 '17-21



REAR STORAGE BOX LOCK & RIDE

» 2878000
TOURING XP 1000 '15-21, TOURING 850 '10-21
Slight interference with Sportsman Touring 550/850 '11-14 passenger handles



AUDIO



NEW FALL AVAILABILITY
REAR AUDIO STORAGE BOX LOCK & RIDE

- Dual 15.2 cm Speakers by Rockford Fosgate that connect via Bluetooth
- Mounts easily with Lock & Ride to the rear rack and is compatible with rack extenders and gun mount
- Rest easy knowing that your speakers are protected with a sealed lid container

» 2884856
 XP 1000 S '20-21, XP 1000 '17-21, 850 '17-21



NEW
AUDIO STORAGE BOX REMOTE

- Easily control the volume or switch to the next song on your Rear Audio Storage Box that conveniently mounts to your ATV's handlebars

» 2884987
 XP 1000 S '20-21, XP 1000 '17-21, 850 '17-21

COMFORT



HANDLEBAR MOUNTED MIRRORS TOP SELLER

- For added safety on or off the trail
- Sold as a pair
- Does not fit with windshield fairing or handguards

» 2877222
 XP 1000 S '20-21, XP 1000 '15-21, TOURING XP 1000 '15-21, TOURING 850 '10-21, 850 '09-21



NEW
HAND & THUMB WARMER KIT

- Provides heat to grips and throttle and is easily installed by plugging into pod
- Includes two heated grips and one throttle warmer

» 2885002
 XP 1000 S '21, XP 1000 '21, 850 '21



HAND WARMERS TOP SELLER

» 2877363
 XP 1000 S '20, XP 1000 '15-20, TOURING XP 1000 '15-21, TOURING 850 '15-21

HANDGUARDS

- BRIGHT WHITE 2876883
- BLACK 2876846
- INDY RED 2876845

- Handguard Mount (2879380) is required when installing Polaris Handguards
- Does not fit with windshields or handlebar-mounted mirrors

» 2879380 • MOUNT
 XP 1000 S '20-21, XP 1000 '15-21, TOURING XP 1000 '15-21, TOURING 850 '10-21, 850 '09-21



THROTTLE/THUMB WARMERS TOP SELLER

» 2877364
 XP 1000 S '20, XP 1000 '15-20, TOURING XP 1000 '15-21, TOURING 850 '15-21

SPORTSMAN 850 XP 1000 XP 1000 S



WINDSHIELDS

NEW

LOCK & RIDE SPORTSMAN WINDSHIELDS

- Provides enhanced protection from the elements and off-road hazards
- Easily installs and removes without tools utilizing Lock & Ride Technology
- Improved mounting system for easier and quicker attachment and detachment

SIZE	COLOR	PART #
TALL 48.9 cm	CLEAR	2884945
MID 39.4 cm	CLEAR	2884845
SHORT 24.1 cm	CLEAR	2884946

XP 1000 S '21, XP 1000 '21, 850 '21



Tall 48.9 cm Clear

Mid 39.4 cm Clear

Short 24.1 cm Clear

LOCK & RIDE WINDSHIELDS TOP SELLER

- Windshield installs in seconds without tools with its Lock & Ride technology. It can also be removed in seconds without tools
- Lock & Ride mounts allow a rider to adjust the height and angle of the windshield
- Poly windshields are flexible, impact-resistant, and provide long-term value over the life of your machine
- Does not work with handguards

SIZE	COLOR	PART #
TALL 48.9 cm	CLEAR	2880539-409
MID 39.4 cm	SMOKE	2880540-412

TOURING XP 1000 '15-'21, TOURING 850 '15-'21



Tall 48.9 cm Clear



Mid 39.4 cm Smoke



DO MORE

LOCK & RIDE **ULTIMATE SERIES WINDSHIELD FAIRING**

- Customizable system based on your style and protection needs
- Install just the fairing or add any of the windshields listed to the right
- Does not work with handguards or handlebar mounted mirror

» 2882512

XP 1000 S '20, XP 1000 '17-20, 850 '17-20



ULTIMATE SERIES WINDSHIELDS

- Fairing required to add your preferred windshield

SIZE	PART #
TALL	2882152
MID	2882151

XP 1000 S '20, XP 1000 '17-20, 850 '17-20



EASY TO CHANGE WINDSHIELDS WITH G-DART INSTALL

Our fairing system allows for changing out the windshield quickly and easily. Simply remove the six dart-t-type fasteners and swap out the windshield.

LIGHTING

SEE P. 48



PLOWS

SEE P. 46



HUNT

SEE P. 50



WHEELS & TIRES

SEE P. 38



SCRAMBLER 850 XP 1000 S



WINCH



POLARIS PRO HD 1,588 kg WINCH

- » 2883580
SCRAMBLER XP 1000 S '20-21
- » 2882241
SCRAMBLER 850 '14-21, SCRAMBLER XP 1000 '14-18



POLARIS TOP SELLER HD 1,588 kg WINCH

- » 2880435
SCRAMBLER 850 '14-21, SCRAMBLER XP 1000 '14-18



POLARIS HD 1,134 kg WINCH

- » 2880433
SCRAMBLER 850 '14-21, SCRAMBLER XP 1000 '14-18

RACKS/STORAGE



LARGE REAR RACK

- » 2879139
SCRAMBLER XP 1000 S '20-21, SCRAMBLER XP 1000 '14-18,
SCRAMBLER 850 '14-21
Not compatible with Ogio Bag (2879925)



OGIO BAG

- » 2879925
SCRAMBLER XP 1000 S '20-21, SCRAMBLER XP 1000 '14-18,
SCRAMBLER 850 '14-21

PROTECTION



ULTIMATE SPORT SERIES FRONT BRUSHGUARD

- » 2883595
SCRAMBLER XP 1000 S '20-21



FRONT BRUSHGUARD

- » 2879136
SCRAMBLER 850 '14-21, SCRAMBLER XP 1000 '14-18
Replaces existing lower bumper. Will not work together



REAR BASH GUARD

- » 2879138
SCRAMBLER 850 '14-21, SCRAMBLER XP 1000 '14-18



MISC SPORTSMAN ACCESSORIES



BOOM SPRAYER

- » 2882266
- ALL SPORTSMAN MODELS EXCEPT TOURING

ATV LICENSE PLATE

- Includes numbers and letters
- » 2873270
- ALL SPORTSMAN MODELS



QUICKTAP BATTERY POSTS

- Easy-to-access terminal posts give you quick access to the battery power
- Ideal for charging your battery, powering a temporary accessory, or when you need to offer an unexpected jump-start
- Connection posts feature covers to protect terminals when not in use
- » 2882110
- X2 570 '15-21, TOURING 570 '14-21, 6X6 570 '17-21, 570 '14-20, 450 H.O. '19-20



RIDE & REPAIR ESSENTIALS KIT

- 12-volt DC portable air compressor
- Tire repair kit with 6 plugs
- Basic first-aid kit with bandages, scissors, safety pins, and more
- 12-volt jumper cables
- Duct tape - 300mm x 1 roll
- Zip ties - 150mm length
- Electrical tape
- Ratchet strap - 50mm
- Microfiber cloth
- Carry bag
- » 2881207

FOR TRAILERING AND RECOVERY STRAPS SEE P. 63

YOUTH ATVs

The perfect first All-Terrain Vehicle for kids starting at 6 years and older.



OUTLAW 70 EFI

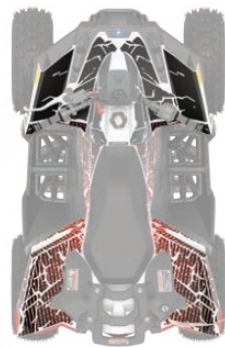

NEW
FRONT BRUSHGUARD

- Provides enhanced protection from brush and other debris on the trail

» 2884567

OUTLAW 70 '21



NEW
DECAL KIT - INDY RED

- Replaces the stock Outlaw 70 decals to provide a unique and custom look for your youth ATV

» 2885107

OUTLAW 70 '21

NEW
REAR BRUSHGUARD

- Protect the rear of your youth ATV from hazards on the trails

» 2884778

OUTLAW 70 '21



NEW
WINDSHIELD - POLY

- Added wind and hand protection with a durable poly design

» 2885005

OUTLAW 70 '21



NEW
REAR STORAGE BAG

- Convenient storage that easily connects to the rear rack of your youth ATV

» 2884555

OUTLAW 70 '21



YOUTH WHEELS & TIRES

NEW

YOUTH CRAWLER TIRE

- Upgraded youth tire for added durability
- Increased ground clearance and performance

ACE 150 '17-21



			TREAD DEPTH	TIRE WEIGHT	PLY RATING	SIDEWALL BELTS	LOAD RATING
14"	22" x 8" R12 5416945	FRONT	13 mm	12 kg	6	3	413 kg
16"	22" x 10" R12 5416944	REAR					

NEW

YOUTH BUCKLE - BLACK

» FRONT • 1524114

ACE 150 '17-21

» REAR • 1524115

ACE 150 '17-21



NEW

PRO ARMOR WHEEL & TIRE SET: YOUTH CRAWLER & BUCKLE

» 2885154

ACE 150 '17-21



ACE 150



POLY ROOF

» 2882263

ACE 150 '17-21

HALF POLY WINDSHIELD

» 2882264

ACE 150 '17-21

FRONT & REAR BRUSHGUARD SET

» 2882472

ACE 150 '17-21

KNOW YOUR TERRAIN



- Tread patterns optimized for extreme traction
- Ideal for both hard pack and loose trail



- Flexible "grippy" tread
- Aggressive side bite



- Provides traction and durability
- Built to perform in hard sand, jagged rocks or any other extreme terrain

SUPERIOR PERFORMANCE & DURABILITY



PRO ARMOR

LIFELONG PERFORMANCE

- Every tire is designed and constructed with longevity in mind
- 3,000+ mile rated (4,828 kilometers)

PREMIUM PROTECTION

- Pro Armor makes tires with extra protection exactly where it's needed most—the sidewall
- Triple-belted sidewalls keep your tires more resistant so you can keep going

TOUGHEST TIRES

- Higher ply ratings mean added protection
- Pro Armor builds 8 or 10-ply rated tires for higher puncture-resistance



KNOW YOUR TIRES

DIMENSIONS			TREAD DEPTH	TIRE WEIGHT	PLY RATING	SIDEWALL BELTS	LOAD RATING
TIRE HEIGHT	TIRE WIDTH	WHEEL DIAMETER					
32" x 9"	R15	FRONT/REAR	30 mm	18 kg	10	3	499 kg
Part Number							
USAGE Where can you use the tire			TREAD DEPTH Deeper treads have more grip in all conditions	TIRE WEIGHT A lighter tire makes for improved vehicle performance	PLY RATING Indicates tire puncture-resistance	SIDEWALL BELTS Increase your resistance to sidewall punctures	LOAD RATING How much weight can the tire handle



- Extra deep treads
- Self-cleaning lugs



- Paddles provide traction and durability in soft sand
- Built to float on top of sand



- Industry leading anti-puncture side walls
- Purpose-built, long lasting tread patterns



- Handles extreme cold
- Holds shape and provides traction

WAYS TO SHOP TIRES

TIRES BY SIZE

26"	27"
ATTACK	MUD XC
DUAL-THREAT	PRESERVE
	HARVESTER
	WHITEOUT

TIRES BY TERRAIN

TRAIL	ROCK	DESERT	MUD	UTILITY	SNOW
DUAL-THREAT	DUAL-THREAT	DUAL-THREAT	MUD XC	ATTACK	ATTACK
ATTACK	ATTACK	ATTACK		HARVESTER	HARVESTER
HARVESTER				PRESERVE	PRESERVE
PRESERVE				XD-K	XD-K
XD-K					WHITEOUT
MUD XC					

TIRES



FRONT/REAR

PRO ARMOR DUAL-THREAT

- Dual-compound technology and radial construction offer performance in all terrains
- Softer durometer rubber on outer edge for overall superior grip and feel
- Harder durometer rubber in the middle for increase traction during acceleration and longer tread life

		TREAD DEPTH	TIRE WEIGHT	PLY RATING	SIDEWALL BELTS	LOAD RATING
34"	26" x 9" R14 5416340	FRONT	12 kg	10	3	413 kg
36"	26" x 11" R14 5416341	REAR	14 kg			504 kg



WHEEL SIZE

14"



FRONT/REAR

PRO ARMOR ATTACK

- The best all-purpose tire for all-season traction in any terrain
- Unique full-face tread design
- Harder durometer lugs promote extended wear, increasing tire life

		TREAD DEPTH	TIRE WEIGHT	PLY RATING	SIDEWALL BELTS	LOAD RATING
34"	26" x 9" R14 5415613	FRONT	13 kg	8	3	413 kg
36"	26" x 11" R14 5415614	REAR	15 kg			599 kg



WHEEL SIZE

14"

COMMON

WINCHES

450-570

850-XP1000-XP1000S

SCRAMBLER 850-XP1000S

MISC 6-YOUTH

WHEELS & TIRES

TRACKS & PLOWS

LIGHTING

HUNT & COOLERS

TIRES



FRONT/REAR

PRO ARMOR HARVESTER

- All-around workhorse with tread life of 8,047 kilometers
- Tread pattern designed to withstand anything from the farmyard to the pastures to the trail
- With 10-ply, it can carry the load day-in and day-out

			TREAD DEPTH	TIRE WEIGHT	PLY RATING	SIDEWALL BELTS	LOAD RATING
14"	26" x 8" R12 5416396	FRONT		11 kg			388 kg
14"	26" x 10" R12 5415966	REAR	16 mm	15 kg	10	3	615 kg
16"	27" x 10" R14 5415965	FRONT/ REAR		15 kg			599 kg



WHEEL SIZE



FRONT/REAR

PRO ARMOR PRESERVE

- Turf-friendly for areas where low impact from tire tread is needed
- Exceptionally quiet-running tire
- Low impact tire

			TREAD DEPTH	TIRE WEIGHT	PLY RATING	SIDEWALL BELTS	LOAD RATING
14"	27" x 10" R14 5416348	FRONT		13 kg			599 kg
16"	26" x 10" R12 5416402	REAR	16 mm	13 kg	10	3	599 kg
14"	26" x 8" R12 5416403	FRONT/ REAR		11 kg			388 kg



WHEEL SIZE



FRONT/REAR

PRO ARMOR XD-K

- 26" Aramid fiber-belted tire can tackle any terrain
- Unique full-face tread design
- Harder durometer lugs promotes for extended wear increasing tire life

			TREAD DEPTH	TIRE WEIGHT	PLY RATING	SIDEWALL BELTS	LOAD RATING
14"	26" x 9" R12 5415756	FRONT		13 kg			388 kg
16"	26" x 11" R12 5415757	REAR	31.7 mm	15 kg	8	3/1 Aramid	499 kg



WHEEL SIZE





FRONT/REAR

PRO ARMOR WHITEOUT

- Extra wide tires for flotation in snow
- Tread pattern designed for superior snow traction with limited digging

		TREAD DEPTH	TIRE WEIGHT	PLY RATING	SIDEWALL BELTS	LOAD RATING
14"	27" x 14" R14 5416032	16 mm	11 kg	8	3	424 kg
		FRONT/REAR				

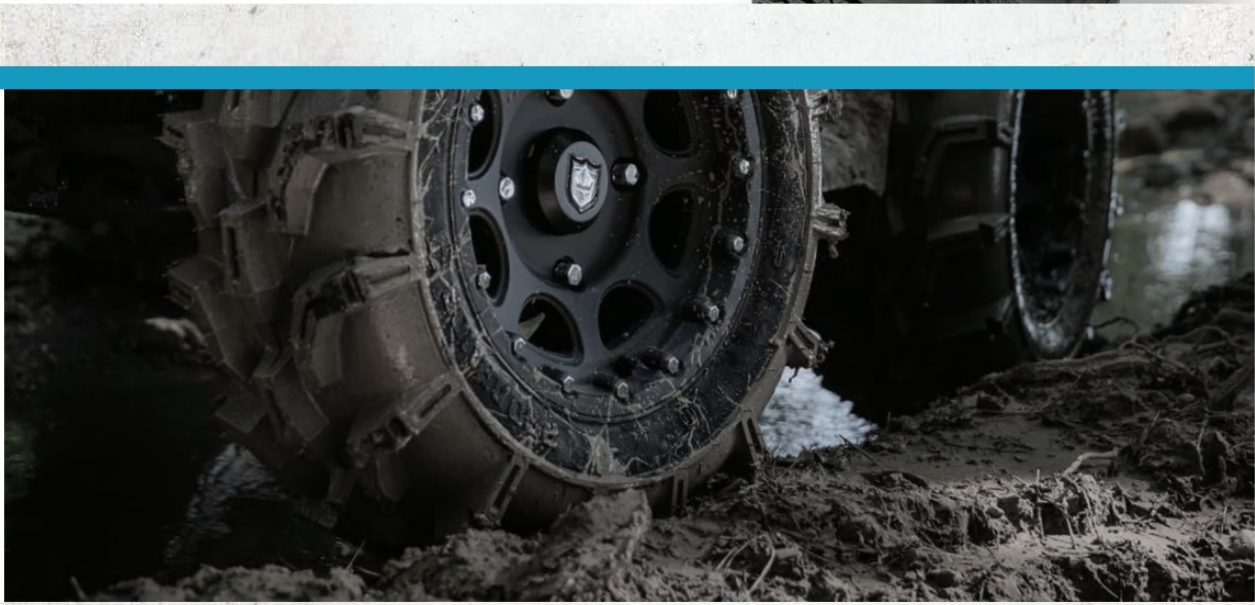

FRONT/REAR

PRO ARMOR MUD XC

- Designed for the perfect mud-trail crossover for a smooth ride on the trail and aggressive traction in the mud
- Dual-compound technology with harder durometer lugs promote extended wear, increasing tire life
- 10-ply construction, means added protection in the toughest terrain

		TREAD DEPTH	TIRE WEIGHT	PLY RATING	SIDEWALL BELTS	LOAD RATING
14"	27" x 9" R14 5416947	30 mm	14 kg	10	3	531 kg
14"	27" x 11" R14 5416948		15 kg			599 kg
		FRONT				
		REAR				



WHEELS



A 4201 (AMPLIFY) ○

FRONT	WEIGHT: 5.9 kg LOAD RATING: 408 kg OFFSET: +4
REAR	WEIGHT: 6.4 kg LOAD RATING: 590 kg OFFSET: -9
ACCENT:	
FRONT	14" × 7" 1522956-266
REAR	14" × 8" 1522957-266
MATTE BLACK:	
FRONT	14" × 7" 1522956-458
REAR	14" × 8" 1522957-458

B 4202 (BUCKLE) ○

FRONT	WEIGHT: 5.8 kg LOAD RATING: 408 kg OFFSET: +4
REAR	WEIGHT: 6.1 kg LOAD RATING: 590 kg OFFSET: -9
ACCENT:	
FRONT	14" × 7" 1522544-266
REAR	14" × 8" 1522545-266
MATTE BLACK:	
FRONT	14" × 7" 1522544-458
REAR	14" × 8" 1522545-458

C 4301 BEADLOCK (COMBAT) ○

WEIGHT: 7.3 kg LOAD RATING: 726 kg OFFSET: -9B	
ACCENT:	
FRONT/REAR	14" × 7" 1523284
MATTE BLACK:	
FRONT/REAR	14" × 7" 1523283

D 4203 BEADLOCK (REBLR) ○

FRONT	WEIGHT: 5.9 kg LOAD RATING: 408 kg OFFSET: +4
REAR	WEIGHT: 6.6 kg LOAD RATING: 590 kg OFFSET: -9
MATTE BLACK:	
FRONT	14" × 7" 1522238-458
REAR	14" × 8" 1522239-458

E 4204 (SHACKLE) ○

FRONT	WEIGHT: 5.9 kg LOAD RATING: 408 kg OFFSET: +4
REAR	WEIGHT: 6.4 kg LOAD RATING: 590 kg OFFSET: -9
ACCENT:	
FRONT	14" × 7" 1522546-266
REAR	14" × 8" 1522547-266
MATTE BLACK:	
FRONT	14" × 7" 1522546-458
REAR	14" × 8" 1522547-458

F 4205 (SIXR) ○

FRONT	WEIGHT: 4.8 kg LOAD RATING: 408 kg OFFSET: +4
REAR	WEIGHT: 5.7 kg LOAD RATING: 590 kg OFFSET: -9
MATTE BLACK:	
FRONT	14" × 7" 1521507-521
REAR	14" × 8" 1521508-521
LUSTER:	
FRONT	14" × 7" 1521507-410
REAR	14" × 8" 1521508-410

G 4206 (SPLIT) ○

FRONT	WEIGHT: 4.3 kg LOAD RATING: 408 kg OFFSET: +4
REAR	WEIGHT: 4.9 kg LOAD RATING: 590 kg OFFSET: -9
MATTE BLACK:	
FRONT	14" × 6" 1522542-458
REAR	14" × 8" 1522543-458

H 4101 (WHITEOUT) ○

WEIGHT: 6.6 kg LOAD RATING: 363 kg OFFSET: -9S	
MATTE BLACK: FRONT/REAR 14" × 10" 1522958	

I HD DUAL BEADLOCK ○

WEIGHT: 18.1 kg LOAD RATING: 725.7 kg OFFSET: +9B	
MATTE BLACK: FRONT/REAR 14" × 7" 1524022-458	

KNOW YOUR WHEELS

STEP 1: SELECT SERIES
4 = 40-SERIES

STEP 2: CHOOSE LOAD RATING
1 = <800 LBS
2 = 801 - 1,300 LBS
3 = 1,301 - 1,600+ LBS

STEP 3: PICK STYLE
OFFSET / BEADLOCK / COLOR

INCREASE OFFSET FROM STOCK = NARROWER STANCE
DECREASE OFFSET FROM STOCK = WIDER STANCE

2 WAYS TO PURCHASE

INDIVIDUAL WHEELS & TIRES
- OR -
COMPLETE SETS AS LISTED

Exclusively at Polaris Authorized Dealers

14" FORGED BEADLOCK RINGS



PRO ARMOR FORGED RINGS Sold individually

	PART #
A Voodoo Blue <small>Only used on 4203 (REBLR)</small>	1522244-619
B Machined	1522244-266
C White	1522244-133
D Indy Red	1522244-293
E Orange Crush	1522244-589
F Beadlock Ring - Matte Black - 14" <small>Only used on 4301 (Combat)</small>	1523146-458

KNOW YOUR TERRAIN



- Tread patterns optimized for extreme traction
- Ideal for both hard pack and loose trail



- Extra deep treads
- Self-cleaning lugs



- Industry leading anti-puncture side walls
- Purpose-built, long lasting tread patterns



- Handles extreme cold
- Holds shape and provides traction

WHEEL & TIRE SETS

	TRAIL		MUD		UTILITY		SNOW	
	ATTACK 26"	DUAL-THREAT 26"	MUD XC 27"	PRESERVE 27"	HARVESTER 27"	WHITEOUT 27"		
40-SERIES								
○ 4201 (AMPLIFY) <i>Accent</i>	2882390	2883138	2884272	2883208	2882388			
○ 4201 (AMPLIFY) <i>Matte Black</i>	2882391	2883139	2884273	2883209	2882389			
○ 4202 (BUCKLE) <i>Accent</i>	2881335	2883140	2884267	2883203	2882383			
○ 4202 (BUCKLE) <i>Matte Black</i>	2881336	2883141	2884268	2883204	2882384			
4301 (COMBAT) <i>Accent</i> BEADLOCKS PRE-MOUNTED		2883217						
4301 (COMBAT) <i>Matte Black</i> BEADLOCKS PRE-MOUNTED		2883216						
○ 4203 (REBLR) <i>Matte Black</i> BEADLOCKS SOLD SEPARATELY	2881381							
○ 4204 (SHACKLE) <i>Accent</i>	2881347	2883142	2884270	2883205	2882385			
○ 4204 (SHACKLE) <i>Matte Black</i>	2881348	2883143	2884271		2882386			
○ 4205 (SIXR) <i>Luster</i>	2881359	2883144						
○ 4205 (SIXR) <i>Matte Black</i>	2881360	2883145	2884269	2883207	2882387			
○ 4206 (SPLIT) <i>Matte Black</i>	2881404							
○ 4101 (WHITEOUT) <i>Matte Black</i>						2882382		

LUG NUTS

○ LUG NUTS REQUIRED



METRIC LUG NUTS FOR ALUMINUM RIMS

- » 2877385 - SET OF 4
- » 2877384 - SET OF 16 SPORTSMAN XP

SAE LUG NUTS FOR ALUMINUM RIMS

- » 2876754 - SET OF 4
- » 2877409 - SET OF 16 SPORTSMAN 450/570

REPLACEMENT CAPS



CENTER CAP

LUSTER	ALL WHEELS EXCEPT 4204 (WYDE) & 4203 (HEXLR)	1521 509-410
MATTE BLACK		1521 509-521
NEW HD MATTE BLACK	ALL WHEELS	5457 498-458



PRO ARMOR CENTER CAP

LUSTER	ALL WHEELS EXCEPT 4204 (WYDE) & 4203 (HEXLR)	5453 209-410
MATTE BLACK		5453 209-458



COLBY VALVE SHORT ULTIMATE VALVE - 2 PACK

- » 2883292



COLBY VALVE EMERGENCY VALVE - 2 PACK

- » 2883293

COMMON

WINCHES

450-570

850-XP1000-XP1000S

SCRAMBLER 850-XP1000S

MISC 6-YOUTH

WHEELS & TIRES

TRACKS & PLOW

LIGHTING

HUNT 6-COOLERS

ALL-TERRAIN TRACTION

It's tough to make Sportsman even more versatile than it already is. But with a set of Prospector Pro Tracks, you'll do just that. Tread through deep snow without concern.

Polaris-specific gearing provides 1:1 ratio to:

- Minimize track slip, providing better climbing ability and improved traction in deep snow
- Improve top speed over prior models by approximately 5%
- Reduce operating RPM for a quieter ride
- Improve driveline durability, which allows vehicle to run at a lower RPM, decreasing engine wear

Polaris exclusive optimized hub geometry that minimizes feedback and eases steering effort

Lightweight design provides for better flotation, eases steering effort, and provides better vehicle control

Flexible lug design provides the highest level of deep snow performance by lifting up in deep snow as opposed to digging down

New front dual stabilizer for improved stability



Prospector[®] PRO
TRACK SYSTEM

		STEP 1 SELECT A MOUNT	STEP 2 SELECT A KIT
MODELS	TYPE	MOUNT	KIT
SPORTSMAN 570 '15-21 SPORTSMAN 570 SP '15-19 SPORTSMAN TOURING 570 '15-21 SPORTSMAN X2 570 '15-21	EPS	2879497	2881025
SPORTSMAN XP 1000 S '20-21 SCRAMBLER XP 1000 S '20-21	EPS	2883977	2881003
SPORTSMAN XP 1000 '17-21 SPORTSMAN 850 '18-21	EPS	2882109	2881003
SCRAMBLER 1000 '15-18 SPORTSMAN TOURING XP 1000 '17-21 SPORTSMAN TOURING 850 '20-21	EPS	2879457	2881003
SPORTSMAN 570 '14-21 SPORTSMAN TOURING 570 '15-21	NON-EPS	2879497	2880020
SCRAMBLER 850 '13-21 SPORTSMAN 850 '15-21	NON-EPS	2879457	2879720
SPORTSMAN XP 1000 '18-21	NON-EPS	2882109	2879720
570 6X6 '17-21	EPS	2882169 Includes Track Mount & Track Kit	

WANT TO PLOW?

GLACIER PRO PLOW TRACK EXTENSION



- Plow extension for use when using the Prospector Pro Track System and Glacier Pro Sportsman plow system

» 2879719

FOR USE WITH GLACIER PRO PLOW SYSTEMS



WANT TO PLOW? SEE P. 46



SPORTSMAN SNOW TRACTION OPTIONS

TREAD THROUGH SNOW WITH THESE OPTIONS	CONTACT PATCH	TURNING RADIUS
 <p>STOCK TIRES</p>	 <p>GOOD</p>	<p>354.3 cm</p> 
 <p>PRO ARMOR WHITEOUT</p>	 <p>BETTER</p> <p>MORE SURFACE AREA FOR BETTER FLOTATION ON SNOW</p>	<p>352.743 cm</p> 
 <p>PROSPECTOR PRO TRACKS</p>	 <p>BEST</p> <p>LESS AGGRESSIVE TREAD DISPLACES SNOW FOR BETTER HANDLING</p>	<p>445.453 cm</p> 

COMMON

WINCHES

450-570

850-XP1000-XP1000S

SCRAMBLER 850-XP1000S

MISC.6-YOUTH

WHEELS & TIRES

TRACKS & PLOW

LIGHTING

HUNT & COOLERS

GLACIER[®]

PLOW SYSTEM

TAKE COMMAND OF CLEARING SNOW AND MAKE QUICK WORK OF EVEN THE HEAVIEST JOBS.



THE POLARIS ENGINEERED ADVANTAGE

INSTALLATION

30 seconds: Drive up, clip in, lock down, and go – the integrated Polaris Engineered Glacier Plow System simplifies plowing.



CONVENIENCE

Lift and angle adjustments can be made from the driver's seat.

ANGLE YOUR BLADE RIGHT FROM YOUR SEAT WITH THE GLACIER PRO PLOW HYDRAULIC ANGLE SYSTEM



ROBUST FRAME

A plow system is only as strong as its frame, and Polaris Engineered plow frames have a wide frame to withstand the rigors of heavy plowing.



DURABLE BLADES

Available in strong stamped steel or corrosion-resistant poly materials, Polaris Engineered plow blades cover a large surface area for quick snow removal.

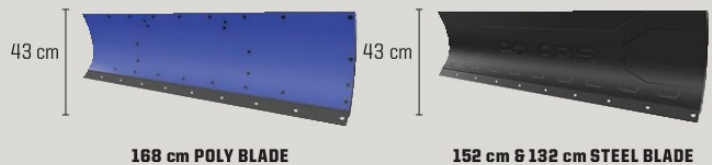

168 cm POLY BLADE

152 cm & 132 cm STEEL BLADE

BUILD YOUR PERFECT PLOW SYSTEM



ADD HYDRAULICS



CONTROL FROM THE PALM OF YOUR HAND
Change the angle of the plow blade with the Power Controller.

HYDRAULIC CONTROL FOR EXTREME SNOW REMOVAL



GLACIER PRO HD GIVES YOU

» **Blades**

» **Choice of poly or steel**

» **Ability to add a hydraulic angle system**

MODELS	MANDATORY STEPS				OPTIONAL
	STEP 1 SELECT A MOUNT	STEP 2 SELECT A FRAME	STEP 3 SELECT PLOW CONFIGURATION		STEP 4 ADD HYDRAULICS
	MOUNT	FRAME	WINCHES	BLADES	HYDRAULICS
XP 1000 '15-21 850 '15-21, 850 SP '15-19 850/XP 1000 HIGHLIFTER '16-21 TOURING XP 1000 '15-21 TOURING 850 SP '15-19 TOURING 850 '10-21 SCRAMBLER 850 '14-21	2881423		Polaris Pro HD 1,588 kg Winch 2882241 Polaris HD 1,588 kg Winch 2880435 Polaris HD 1,134 kg Winch 2880433		
XP 1000 S '20-21 SCRAMBLER XP 1000 S '20-21	2883581		Polaris PRO HD 1,588 kg Winch 2883580		
570 SP '15-19 570 '15-20 6X6 570 '17-21 X2 570 '15-21 TOURING 570 SP '15-19 TOURING 570 '14-21 450 H.O. '12-20		2879630	Polaris HD 1,588 kg Winch 2880434 Polaris HD 1,134 kg Winch 2880432	168 cm Poly 2880269 152 cm Steel 2879638 132 cm Steel 2879639	Hydraulic Plow Blade Angle System 2879635 Power Controller 2880836 Power Controller Recommended
450 H.O. '21 570 '21	2881424		Polaris Pro HD 1,588 kg Winch 2884834 Polaris HD 1,588 kg Winch 2884833 Polaris HD 1,588 kg Winch 2884832		

STEP 5

SELECT ACCESSORIES & REPLACEMENT ITEMS

ACCESSORIES & REPLACEMENT ITEMS

168 cm HD Wear Bar 2879868 168 cm Wear Bar 2879867 152 cm Wear Bar 2877243 132 cm Wear Bar 2877210	168 cm Plow Blade Snow Deflector 2879866 Plow Blade Deflector 2871808 Skid Shoe 2205071 Glacier Pro Shear Pin Replacement 2205063	Plow Winch Rope For 1,134 kg & 1,588 kg winches 2878483 Glacier Plow Marker Sold in pairs 2872726 Rear Tire Chains Recommended for rear tires only 2881422 Plow Blade Track Extension Required for track equipped vehicles 2879719
---	--	---

NEED TRACKS? SEE P. 44

RIGID

POLARIS ENGINEERED
ADVANTAGES

MOUNTS PERFECTLY
Designed for your Polaris Engineered bumper, roof or other mounting point

ADVANCED TECH

RIGID lights are driven by Aluminum PCB Smart Boards™, 6063-T5 aircraft aluminum extruded housings and Tiger Drylac UV protection polyester powdercoating.

EXCLUSIVE OPTICS

RIGID lights feature impact-resistant polycarbonate lenses for a 100% water/dustproof seal.

LIGHT BAR TYPES



SR-SERIES PRO

Sleek, powerful, low-profile (under 5 cm tall). Lights extreme distances with low energy usage. Available in 25.4 cm



D-SERIES PRO

Compact to fit almost anywhere with high output and low energy usage. Available in Driving, Flood & Spot

LIGHT BAR OPTIONS

OPTICS DRIVING

FLOOD



BUILD YOUR VISION

Consider the Optics, Angle & how you will use your vehicle to choose the right light or set of lights.

OPTICS LIGHT ANGLE	ACCENT	DRIVING (45°)	FLOOD (25°)	SPOT (10°)	COMBO (25°/10°)
DRIVING SPEED	All	Slow	Medium	Fast	Medium to fast
BEAM	Diffused glow	Extra-wide	Wide/Shorter	Concentrated/Long	Inner spot & outer flood
RECOMMENDED MOUNTING	Low/Wheel well	All points	Low &/or rear	High points	All points
TERRAIN & RIDING STYLE	Added style & personalization in any terrain	All riding & utility	Wide-open terrain or trails & utility	Trail & tight conditions	All riding & utility

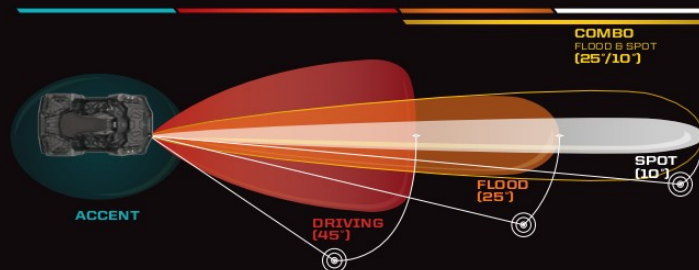

MAX PERFORMANCE
Validated to work as hard as your machine does

DOESN'T OVERTAX
Trust it to work when you need it to



RUGGED CONSTRUCTION

Pro Armor lights are designed to be big and beefy with an aggressive style all their own, and housed in IP67 marine-grade rated UV polyester powdercoating.

MASSIVELY BRIGHT

Pro Armor builds bright lights designed for any riding experience. All that power is directed through heat dissipating aluminum for streamlined heat management.



DUAL-ROW LED LIGHT BARS

The most spread and farthest illumination downrange. Easy to mount.
Available in Cube, 25.4 cm & 50.8 cm



SINGLE-ROW LED LIGHT BARS

Powerful, compact, low-profile light bars with a sleek look.
Available in 27.9 cm & 50.8 cm



CUBE LED LIGHTS

Small size allows mounting in strategic locations for added lighting.
Available in Flood & Spot

SPOT

COMBO

OPTICS

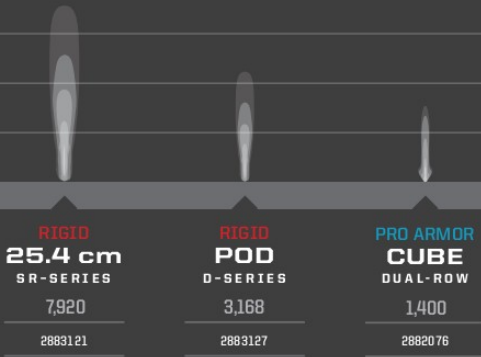

BRAND SIZE
TYPE
RAW LUMENS
PN

LED LIGHTING



NEW LED LIGHT KIT

Upgrade your standard headlights and pod lights to LEDs with this upgrade kit
» 2884859
XP 1000 '21, 850 '21, 570 '21, 450 H.O '21

ACCENT LIGHTING

ACCENT LIGHT KIT

- Durable off-road ready construction that is both dust- and water-resistant
- Features CREE LED for a long-lasting, brilliant light
- Set includes four LED pods

COLOR	LIGHTING KIT
RED	2880500
BLUE	2880506

WIRING HARNESSES

LIGHTBAR HARNESS

- Control one light with one switch
» 2882320
ALL SPORTSMAN MODELS

LED Y-HARNESS

- Y-Harness requires 2882320 to control two cubes or two lights with one switch
» 2879860
ALL SPORTSMAN MODELS

COMMON

WINCHES

450-570

850-XP1000-XP1000S

SCRAMBLER 850-XP1000S

MISC.6-YOUTH

WHEELS & TIRES

TRACKS & PLOWNS

LIGHTING

HUNT & COOLERS

PROTECTING YOUR ESSENTIAL GEAR SINCE 1943

KOLPIN STRONGHOLD SYSTEM

Polaris is proud to partner with Kolpin Outdoors, an industry leader in off-road accessories and the premier name in gun boots and mounts. If you need to secure a firearm while riding, simply attach the auto-latch mount and choose your case.

IDEAL FOR SECURE TRANSPORT OF SCOPED RIFLES AND SHOTGUNS

STEP 1 CHOOSE YOUR MOUNT



STEP 2 CHOOSE YOUR BOOTS



AUTO-LATCH BOOT MOUNT

- Precision angle adjustable for a custom fit
- Provides a quick and secure attachment point

» 2882272

XP 1000 S '20-'21, XP 1000 '17-'21, 850 '17-'21
Does not fit with bodyguard Brushguard (2882090)

NEW

GUN BOOT MOUNT

- The Auto-latching design provides quick and secure Kolpin Stronghold product attachment
- Bracket is made from rugged high impact, reinforced nylon and coated steel with precision angle adjustment for a custom fit
- For use with the Kolpin Stronghold line of products (sold separately)

» 2884846

570 '21, 450 H.O. '21

GUN BOOT XL – TRANSPORT

- Lockable and TSA Approved
- 132.1 cm L x 9.5 cm W x 26.6 cm H

» 2882430

XP 1000 S '20-'21, XP 1000 '17-'21, 850 '17-'21,
570 '19-'21, 450 H.O. '21
Requires Auto-Latch Mount
(2882272 or 2884846)



Never transport a loaded firearm. Verify firearm is unloaded prior to mounting. Please refer to local laws and regulations regarding the requirements for the legal transport of firearms.

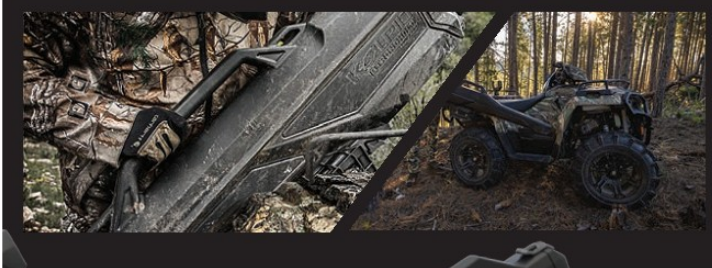

GUN BOOT L

• 132.1 cm L x 12.1 cm W x 23.5 cm H

» 2882426

XP 1000 S '20-21, XP 1000 '17-21, 850 '17-21, 570 '14-21, 450 H.O. '19-21

Requires Auto-Latch Mount (2882272 or 2884846)

KOLPIN RHINO GRIP

IDEAL FOR CARRYING RIFLES, SHOTGUNS, BOWS AND CROSSBOWS.



LOCK & RIDE

RHINO GRIP PRO

» 2884119

» 2884109 • REPLACEMENT RUBBER STRAPS

ALL SPORTSMAN MODELS (EXCEPT UTILITY EDITIONS & YOUTH)



LOCK & RIDE

RATCHETING RHINO GRIP

» 2881157

XP 1000 '15-21, X2 570 '15-21, TOURING XP 1000 '15-21, TOURING 850 '10-20, TOURING 570 '14-21, 850 '09-21, 6X6 570 '17-21, 570 '14-21, 450 H.O. '12-21



NEW LOCK & RIDE

RHINO GRIP XLR

» 2889147

» 2889204 • HEAVY-DUTY XLR REPLACEMENT RUBBER STRAPS (2)

ALL SPORTSMAN MODELS (EXCEPT UTILITY EDITIONS & YOUTH)



NEW LOCK & RIDE

RHINO GRIP XLR - DOUBLES

» 2889148

» 2889204 • HEAVY-DUTY XLR REPLACEMENT RUBBER STRAPS (2)

ALL SPORTSMAN MODELS (EXCEPT UTILITY EDITIONS & YOUTH)



KOLPIN GUN BOOT IV

• For 50mm scopes, rifles with slings attached, or shotguns up to 129.54 cm in length

» BLACK • 2872677

» MOSSY OAK BREAK-UP • 2872677-419



2872677



2872677-419

LOCK & RIDE GUN BOOT MOUNTS

• High-impact case secures firearm over any terrain

• Works with Lock & Ride XL Storage Box, Lock & Ride Rear Cargo Box, and Rear Rack Extenders

» 2878001

TOURING XP 1000 '15-21, TOURING 850 '10-20, TOURING 570 '21

COMMON

WINCHES

450-570

850-XP1000-XP1000S

SCRAMBLER 850-XP1000S

MISC 6-YOUTH

WHEELS & TIRES

TRACKS & PLOW

LIGHTING

HUNT COOLERS

**POLARIS
NORTHSTAR
COOLER**

**KEEP IT
ICE COLD**



**28, 57 & 99
LITER FEATURES**

ComfortCarry
Handles

TravelLock
System

EasyOut
Drain System

NoSlip
Rubber Feet

 5 cm
PolarWall
Insulation

IceLock
Seal



99 LITER

- » GRAPHITE • 2883426
- » DESERT • 2883392



57 LITER







- » GRAPHITE • 2883425
- » DESERT • 2881259

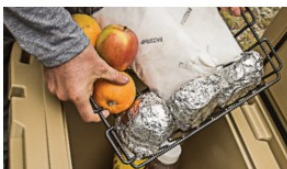

28 LITER

- » GRAPHITE • 2883424
- » DESERT • 2881315

ESSENTIAL ACCESSORIES SO YOUR COOLER WORKS AS HARD AS YOU DO

COOLER ACCESSORIES	99 LITER	57 LITER	28 LITER
 <p>WIRE BASKET</p>	2883648	2882185	2882438
 <p>DIVIDERS Doubles as cutting board</p>	2883468 COMES WITH ONE DIVIDER  1 way to partition	2882184 COMES WITH TWO DIVIDERS  2 ways to partition	2882186 COMES WITH ONE DIVIDER  1 way to partition
 <p>SEAT CUSHION</p>	NOT AVAILABLE	2882179	2882507
<p>WHEELS</p>	2883967	2882180	NOT AVAILABLE

GRIZZLY TESTED. POLARIS APPROVED.



This cooler is IGBC-approved, meaning it withstands the power expended by a typical grizzly bear if it was trying to get inside.

Seriously, there are experts who know what a grizzly is capable of doing, and they certify our coolers can take it.



POLARIS NORTHSTAR COOLERS CAN SURVIVE JUST ABOUT ANYTHING - FROM EXTREME HEAT TO A NASTY TUMBLE OFF A VEHICLE.



14 LITER

» GRAPHITE • 2883968



19 LITER SOFTSIDED COOLER

» GRAPHITE • 2883390

DON'T FORGET THESE ACCESSORIES



887 mL

TUMBLERS

» 887 mL • 2883394
» 591 mL • 2883393



BOTTLE OPENER

» 2882183
ALL COOLERS

COMMON

WINCHES

450 - 570

850 - XP 1000 -
XP 1000 S

SCRAMBLER
850 - XP 1000 S

MISC. 6-YOUTH

WHEELS & TIRES

TRACKS & PLOW

LIGHTING

HUNT & COOLERS

FOR THE LIFE OF YOUR RIDE

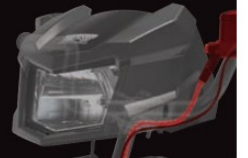

MAINTENANCE TIP

BREAK-IN PERIOD

The break-in period for your new Sportsman is the first 25 hours of operation, or the time it takes to use the first two tanks of fuel. No single action on your part is as important as a proper break-in period. Careful treatment of a new engine will result in more efficient performance and longer life for the engine.

NOTICE: Excessive heat build-up during the first three hours of operation will damage close-fitted engine parts. Do not operate at full throttle or high speeds for extended periods during the first three hours of use.

BATTERIES

To ensure a battery maintains its level of charge when unused for extended periods of time or during freezing weather, the battery should be connected to a suitable battery charger. Consult your dealer to ensure the charger is compatible with your vehicle.

BRAKE PADS

Maintaining and/or replacing brakes are critical to the safety and functionality of a vehicle. Brake pads should be checked for wear and oil or grease (petroleum products) contamination and brake discs should be checked for cracks, excessive corrosion or warping.

HALF SHAFT

Check for tear and punctures in the boot which can lead to CV joint wear that can contribute to axle failure.

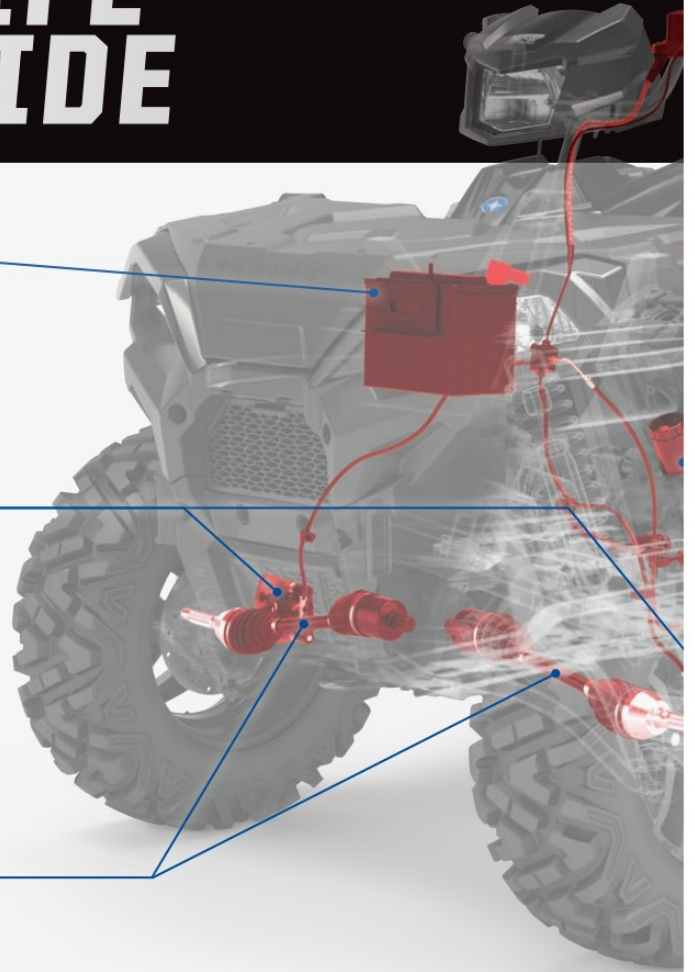

MAINTENANCE SCHEDULE

25 HRS / 400 km

BREAK-IN MAINTENANCE

- ENGINE OIL:**
CHANGE
- GENERAL LUBRICATION:**
ALL FITTINGS, PIVOTS, CABLES, ETC.
- GEARCASES:**
CHECK OIL LEVEL
- AIR FILTER:**
INSPECT & REPLACE AS NEEDED
- EXHAUST SYSTEM:**
INSPECT & CLEAN
INSPECT FOR LEAKAGE OR CARBON BUILD UP AT JOINTS
INSPECT & CLEAN SCREEN TYPE SPARK ARRESTOR

50 HRS / 800 km

6 MONTHS

- EXHAUST SYSTEM:**
INSPECT & CLEAN
INSPECT FOR LEAKAGE OR CARBON BUILD UP AT JOINTS
INSPECT & CLEAN SCREEN TYPE SPARK ARRESTOR
- GENERAL LUBRICATION:**
ALL FITTINGS, PIVOTS, CABLES, ETC.
- DRIVE BELT:**
INSPECT & ADJUST
REPLACE AS NEEDED

100 HRS / 1600 km

12 MONTHS

- ENGINE OIL:**
CHANGE
- DRIVE BELT:**
INSPECT & ADJUST
REPLACE AS NEEDED
- EXHAUST SYSTEM:**
INSPECT & CLEAN
INSPECT FOR LEAKAGE OR CARBON BUILD UP AT JOINTS
INSPECT & CLEAN SCREEN TYPE SPARK ARRESTOR

150 HRS / 2400 km

18 MONTHS

- BATTERY:**
TEST, CLEAN, & CHECK FLUID LEVEL
REPLACE AS NEEDED
- DRIVE BELT:**
INSPECT & ADJUST
REPLACE AS NEEDED
- TIRES:**
INSPECT CONDITION & PRESSURE
- EXHAUST SYSTEM:**
INSPECT & CLEAN
INSPECT FOR LEAKAGE OR CARBON BUILD UP AT JOINTS
INSPECT & CLEAN SCREEN TYPE SPARK ARRESTOR

POLARIS ENGINEERS PARTS THAT PUSH THE LIMITS WITHOUT SACRIFICING STRENGTH AND DURABILITY. We build our products so anyone with the right tools can maintain their vehicle from their own garage - and get them back on the trails where they belong.

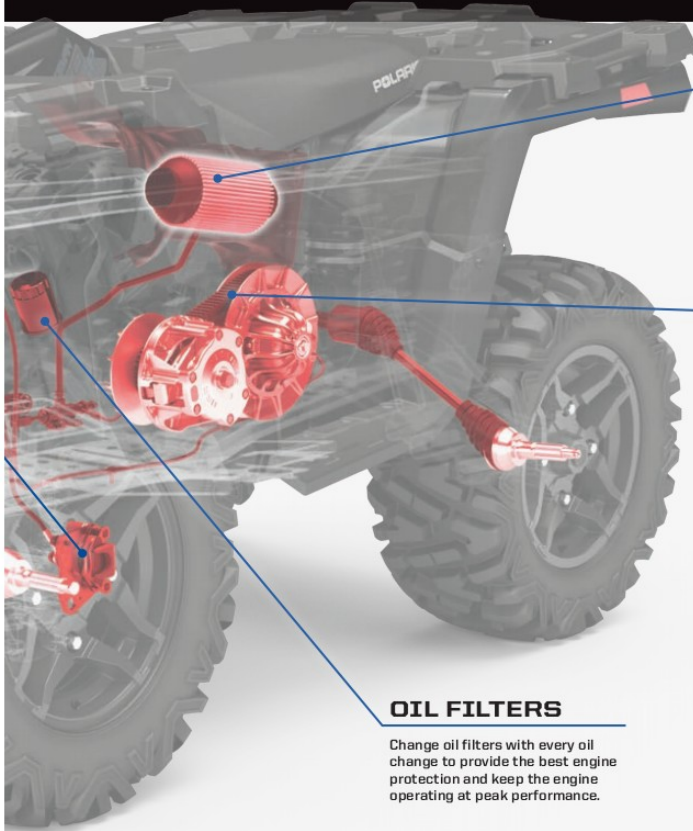

AIR FILTERS

A clogged air filter can restrict air flow to the engine leading to reduced engine performance, engine life or catastrophic failure.

DRIVE BELTS

Polaris Engineered belts deliver unmatched performance for your off-road vehicle. Developed and tested on all our engines for all environments and conditions. Check your belt for delamination, hour glassing and glazing.

BREAK-IN PERIOD

- Use lower gear (if available) while varying speeds and avoiding wide open throttle for 8-16 km
- If no low gear is available, vary at moderate speeds while avoiding wide open throttle for 80 km

OUR INVESTMENT

- 32,187 km of field testing
- Thousands of dyno hours
- 18+ months of development (3,000+ design hours) per belt
- 1200+ vehicle validation hours
- Collaboration with powertrain & clutch engineers

YOUR ADVANTAGE

- No clutch recalibration
- Less wear & tear due to heat
- Ensure maximum vehicle performance
- More time riding, less time wrenching
- Produced in collaboration with powertrain and clutch engineers to ensure a perfect fit, maximum performance and ultimate durability

OIL FILTERS

Change oil filters with every oil change to provide the best engine protection and keep the engine operating at peak performance.

FOLLOW RECOMMENDED SERVICE INTERVALS IN THE OWNER'S MANUAL

200 HRS / 3200 km

24 MONTHS

- ENGINE OIL:** CHANGE
- TRANSMISSION FLUID:** CHANGE
- GEARCASES:** CHECK OIL LEVEL
- BRAKE PADS & FLUID:** INSPECT & CLEAN
REPLACE AS NEEDED
- SPARK PLUGS:** INSPECT
REPLACE AS NEEDED
- EXHAUST SYSTEM:** INSPECT & CLEAN
INSPECT FOR LEAKAGE OR CARBON BUILD UP AT JOINTS
INSPECT & CLEAN SCREEN TYPE SPARK ARRESTOR

250 HRS / 4023 km

30 MONTHS

- ENGINE OIL:** CHANGE
- BATTERY:** TEST, CLEAN, & CHECK FLUID LEVEL
REPLACE AS NEEDED
- DRIVE BELT:** INSPECT & ADJUST
REPLACE AS NEEDED
- GENERAL LUBRICATION:** ALL FITTINGS, PIVOTS, CABLES, ETC.
- EXHAUST SYSTEM:** INSPECT & CLEAN
INSPECT FOR LEAKAGE OR CARBON BUILD UP AT JOINTS
INSPECT & CLEAN SCREEN TYPE SPARK ARRESTOR

300 HRS / 4828 km

36 MONTHS

- ENGINE OIL:** CHANGE
- AIR FILTER:** INSPECT & REPLACE AS NEEDED
- GEARCASES:** CHECK OIL LEVEL
- EXHAUST SYSTEM:** INSPECT & CLEAN
INSPECT FOR LEAKAGE OR CARBON BUILD UP AT JOINTS
INSPECT & CLEAN SCREEN TYPE SPARK ARRESTOR

CHECK YOUR OWNER'S MANUAL FOR ADDITIONAL RECOMMENDED SERVICE ITEMS AND VEHICLE-SPECIFIC TIMING



SPECIFIC NEEDS, *SPECIFIC OILS*

Polaris invests millions in engine development, and part of that investment is making sure its lubricants—critical to engine performance—are the right formula for your specific engine. The amount of testing data and engineering resources used in developing Polaris lubricants would overwhelm an aftermarket company. Therefore, the aftermarket must spec an oil to an industry-wide standard that must account for a variety of operating parameters.

PS-4 is designed specifically for Polaris 4-cycle engines and has high film strength and wear protection under extreme loads and temperatures. Exclusive anti-wear additives protect engine parts with extra rust and corrosion protection.

PS-4 FULL-SYNTHETIC OIL

• PS-4 is optimal for ambient operating temperatures of -40° C to 38° C

- › 1L • 2877263
- › 4L • 2877264
- › 25L • 2877868
- › 60L • 502338
- › 200L • 2878003

PS-4 OIL CHANGE KIT

• Contains the correct amount of oil for your vehicle and correct oil filter

- › 2202166
SINGLE 570, TWIN 600, TWIN 700, TWIN 800
- › 2879323
RANGER/RZR 900/1000
- › 2880913
POLARIS ACE/ETX 325
- › 2877473
330500, SPORTSMAN 550/850/1000

PS-4 EXTREME-DUTY FULL-SYNTHETIC OIL

• PS-4 Extreme Duty is optimal for ambient operating temperatures of -18° C to 53° C

- › 1L • 2879037
- › 4L • 2879251
- › 25L • 2879252
- › 60L • 2879003
- › 200L • 2879038

POLARIS

ENGINEERED PARTS
& LUBRICANTS

FOR THE LIFE OF YOUR RIDE ONLY THE BEST WILL DO

To create the best oil for any terrain, we invest in rigorous testing to ensure our oil delivers the consistency and performance you demand. The results are Polaris Engineered Lubricants that are tested and perfected to deliver excellent total engine protection for the life of your ride.

WHAT COUNTS IN OIL TESTING:

1. Does it protect the engine at high temperatures?
2. Does it keep the engine free from carbon and buildup?
3. Does the oil hold its viscosity over time?

ENGINE CHECKPOINTS

When evaluating an engine oil and its ability to protect and preserve the engine's power output and lifespan, Polaris engineers focus on key areas within the engine, some of the most critical ones include:

RING LANDS: Poor oxidative performance can lead to carbon and varnish buildup, which results in poor ring seal and loss of power, combustion blow by and fuel dilution of the oil.

PISTON RINGS: During the combustion process, extreme pressures are placed on the top ring, forcing it outward toward the cylinder wall, sealing the combustion chamber. With so much force applied, poor oil film strength between the top ring and the cylinder wall can lead to cylinder wear and loss of power.

ROD BEARINGS: Engine bearings ride on an extremely thin hydrodynamic film of oil. Poor oil film strength or using an oil with a thinner viscosity, can lead to premature bearing wear or even engine failure. Using an oil with high film strength and a strong viscosity, like PS-4 full synthetic, will extend the service life of your engine.

CAMSHAFT: Direct Acting Overhead Camshafts are used on many Polaris Prostar Engines. In this application the camshaft pushes directly on the valve, creating very high contact pressures compared to other camshaft configurations. These forces are so great that inferior oil can break down and be forced out of the contact area leading to increased wear. PS-4 full synthetic additives are specifically designed to provide wear protection against this.

OIL DEVELOPMENT

**12 DEDICATED
TEAM MEMBERS**

**FOCUSED ON
POLARIS OIL**

**18+
MONTHS**

**DEVELOPMENT
& TESTING**

**75,000+
HOURS**

**DYNO
TESTING**

**64,374
KILOMETERS**

**FIELD
TESTING**

ENGINEERED TO MAXIMIZE THE LIFE OF YOUR RIDE

All Polaris fluids—from anti-freeze to brake fluid—are developed for your vehicle. Trust the only fluids perfectly engineered for your needs.

DOT 4 BRAKE FLUID

Polaris DOT 4 Brake Fluid is a high-quality brake fluid designed for use in Polaris hydraulic brakes. Superior high-temp characteristics plus anti-corrosive additives extend the life of brake system components and provide consistent, positive braking.

- » 250 mL • 502081

ANTI-FREEZE

Polaris Extended Life Coolant contains organic acid technologies to prevent corrosion on metal components, eliminate scaling, and maximize cooling system performance.

- » 1 L • 502103
- » 25 L • 502271
- » 206 L • 502091

AGL

A proprietary blend of additives designed to optimize Polaris® ORV transmission life. Extreme pressure additives protect gears, drive chain, and bearings from scoring and wear. Unlike typical gear case oils, AGL's unique viscosity range allows instant flow and film protection in extreme cold or high heat environments.

- » 1 L • 502080
- » 200 L • 502151
- » 25 L • 502152

DEMAND DRIVE FLUID

Engineered specifically for Polaris ORV front drive systems. Provides positive 4WD engagement in extreme cold or high heat conditions. Unique friction additives protect internal components under heavy loads and promote positive engagement.

- » 1 L • 502094
- » 200 L • 502264
- » 25 L • 502267

Proper lubricant application and timing will ensure optimal vehicle performance. Please refer to your owner's manual for lubricant change interval schedules.

CARBON CLEAN

Polaris Carbon Clean prevents ethanol corrosion, stabilizes fuel, and cleans fuel injectors, piston ring lands, intake systems, and combustion chambers. Helps maintain peak HP and improves fuel economy.

- » 125 mL • 502082

FUEL STABILIZER

Fuel Stabilizer prevents ethanol corrosion and stabilizes fuel for up to 2 years. Dual-antioxidant formula protects against gum and varnish for easy starting.

- » 125 mL • 502100

ANGLE DRIVE FLUID

- » 1 L • 502089
- » 25 L • 502268
- » 202 L • 502266

SPORTSMAN, RANGER, RZR ANGLE DRIVE GEAR CASE SYSTEMS

PREMIUM GAS SHOCK OIL

- » 1 L • 502098

ALL-SEASON GREASE TUBE

- » 400 g • 502068

SERVICE PARTS

Polaris Engineered service parts deliver unmatched performance and fit for your off-road vehicle.

All service parts are engineered specifically for your machine. Which means everything is designed, tested and perfected to maximize the life of your ride. Getting Polaris Engineered parts is a decision that pays off in the long run, because it ensures there is a long run.



**VISIT YOUR POLARIS DEALER TO
SHOP FOR SERVICE PARTS.**

OVER
100,000
PARTS
AVAILABLE



FOR THE LIFE OF YOUR RIDE

Maintenance is the key to keeping your Polaris off-road vehicle performing at its peak. Items like belts, lubricants, and batteries represent only a few of these critical items engineered specifically by Polaris.



POLARIS ENGINEERED DRIVE BELTS

TESTED, PERFECTED

We test each belt on the intended vehicle - we don't just try to make an existing belt "just work".

- Amery Kuhl, Polaris CVT System Engineer

OUR INVESTMENT

- 32,187 km of field testing
- Thousands of dyno hours
- 18+ months of development (3,000+ design hours) per belt
- 1200+ vehicle validation hours
- Collaboration with powertrain & clutch engineers

YOUR ADVANTAGE

- No clutch recalibration
- Less wear & tear due to heat
- Ensure maximum performance of your vehicle
- More time out riding, less time wrenching

**OUR INVESTMENTS ENSURE POLARIS BELTS
OUTPERFORM YOUR EXPECTATIONS.**

HD HEAVY DUTY PARTS

All Polaris parts are developed and tested to help you get the most out of your ride. Now, we're taking the passion of our riders, workers, and outdoor enthusiasts to the next level with HD Parts.

Engineered & designed for:

- Greater durability
- Enhanced performance
- Greater wear & tear capabilities
- All weather conditions



NEW WHEEL BEARINGS

Fully sealed for added protection against intrusions. Made of a higher grade steel for extended life in extreme conditions.

LOCATION	OEM	HD HEAVY DUTY PARTS
FRONT WHEEL BEARINGS	3514822	3515090
	3514634	3515088
REAR WHEEL BEARINGS	3514917	3515087



NEW BUSHING KITS

Easily update the entire front and rear suspension.

- » **2830562 (SHOWN)**
570 EFI '16-'20, 570 EFI X2 '16-'20, 570 EFI TOURING '16-'20, 570 EPS UTILITY '20, 450 HO '16-'20, 450 UTILITY '20
- » **2830563**
570 SP '16-'19, 570 PREMIUM '19, 570 SP TOURING '16-'20

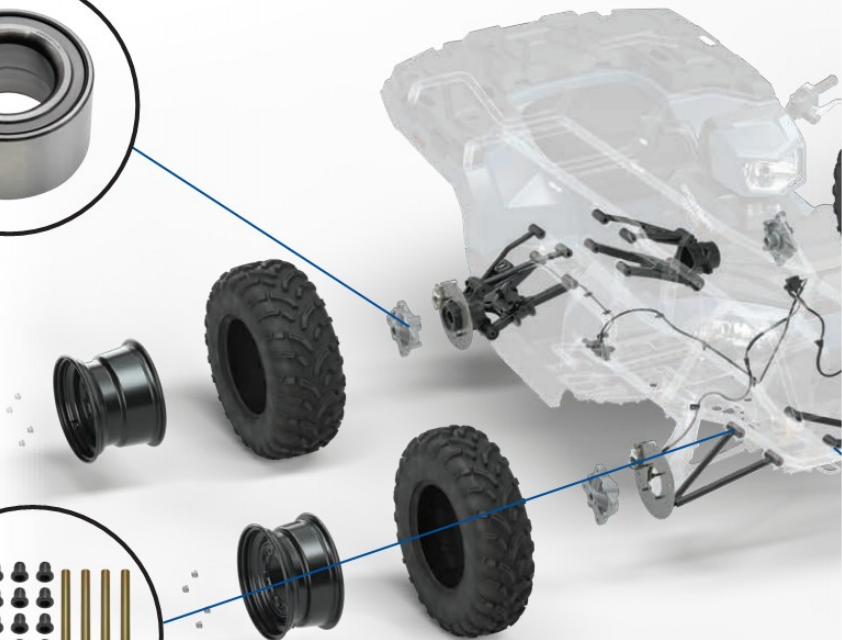

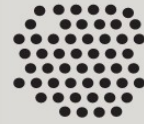

SAND



MUD



WATER



EXTREME COLD



EXTREME HEAT UP TO 54° C



HEAVY PAYLOADS



EXTENDED LIFE

PARTS & GARAGE

OIL & LUBRICANTS

MAINTENANCE

HD PARTS

HD PARTS

BATTERY & LIFTS

VEHICLE CARE & TRAILERING

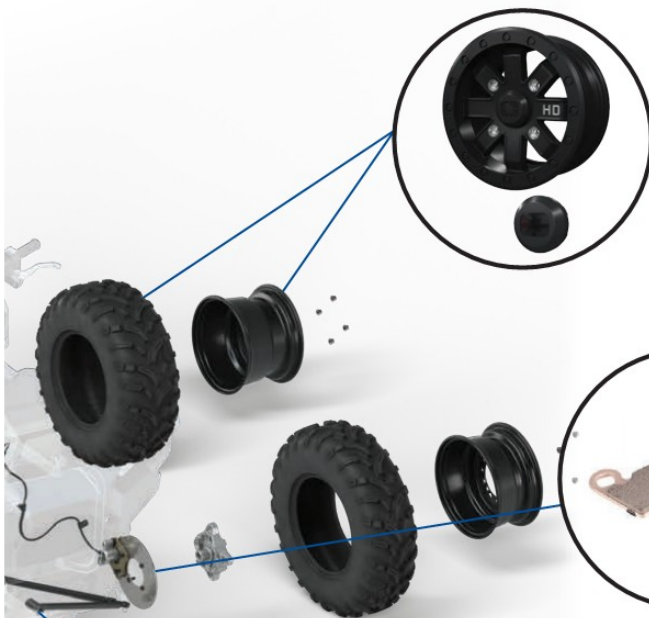

NEW
WHEELS & TIRES

Class leading durability for off-road performance and traction for confident driving in extreme conditions.

- » 1524022-458 • HD WHEEL - 14x7
- » 5457498-458 • HD WHEEL CENTER CAP

COMING SOON
BRAKES

Engineered to provide longer life and better stopping power while riding in extreme conditions.

NEW
BUSHINGS

The advanced material compound of the bushings enables tighter tolerances to reduce overall wear on the system, while the superior triple lip sealing prevents intrusion of the elements.

LOCATION	OE	HD <small>HEAVY DUTY PARTS</small>
FRONT UPPER BUSHINGS	5439874	1543367
FRONT LOWER BUSHINGS	5439874	1543367
	5436973	1543326
REAR UPPER BUSHINGS	5439874	1543367
	5438895	1543326
REAR LOWER BUSHINGS	5439874	1543367
	5436973	1543326

For more information regarding Polaris HD parts including vehicle compatibility, installation, and maintenance, please contact your authorized Polaris ORV dealer.

CV BOOT REPAIR KIT

FIX ON THE GO | TEMPORARY COVERAGE

- A quick trail side fix to increase trail time
- The flexible and durable boot material expands over a cone tool for CV boot repairs, without disassembling CV axles
- Universal fit - works as a temporary fix for most powersports axles
- All components fit inside the cone, and a cover is provided for compact durable storage
- Easily fits in a cargo box, attached to the roll cage, in the glovebox, or many other storage locations



Items shown are contained inside cone

ATV CV BOOT REPAIR KIT

Kit includes the following items:

- (1) Expandable CV Boot
 - (1) Reusable Cone Tool
 - (2) CV Boot Clamps
 - (1) Tube of Silicone Lube
 - (1) Grease Packet
 - (1) Cone Cover
- » 2830528

ATV TRAIL BOOT ONLY

» 2830529

UTV

- » CV REPAIR KIT 2830526
- » TRAIL BOOT ONLY 2830527

HOW TO INSTALL

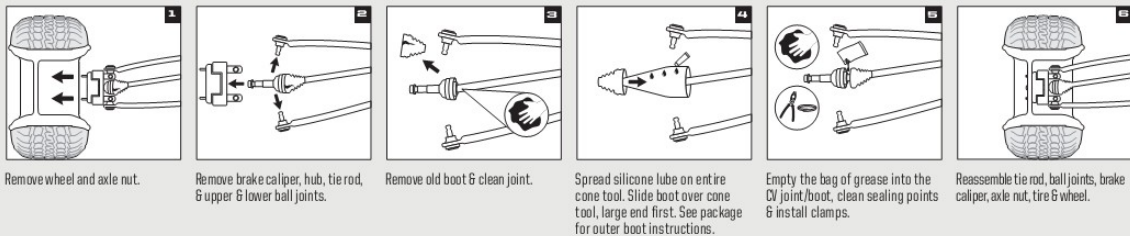

Refer to your service manual for further instructions and torque specifications.
*Designed for temporary CV boot repair. Purchase the OEM CV Boot for a permanent repair.

KEEP IT CLEAN

CLEAN

ALL-PURPOSE CLEANER

- Professional cleaner, which is formulated with a low pH-value. The product spreads well on surfaces and adheres on them for effective cleaning action. Perfectly compatible with rubber, plastic and painted surfaces. The formulation is biodegradable.

» 500 mL • 502309

SHINE

INSTANT SHINE & DETAILER

- The INSTANT SHINE AND DETAILER is developed for cleaning action without water. Removes insects, dust and dirt with almost no effort. Applicable for plastics, visors, windscreens, paint and metal. The wipe and shine formulation makes surfaces shine, works water repellent and also has an antistatic effect. Perfect for customers living in urban areas with no access to water, for bike trips or showroom bikes.

» 500 mL • 502303



BRING IT EVERYWHERE

TRAILERING



CALIBER RAMP PRO

- Designed for ATVs and UTVs up to 127 cm wide
 - Integrated grip glides for ultimate traction
 - Folding sides for easy transportation & storing
- » 132 cm x 229 cm • 2884576



ALUMINUM ARCHED LOADING RAMP

- » 193 cm x 30.5 cm • 907 kg • 2875384
- » 224 cm x 30.5 cm • 1361 kg • 2875386



LIGHTWEIGHT TRI-FOLD RAMP

- Ramp folds up for transport
 - Capacity for up to 680.7 kg
 - Safety straps included
- » 183 cm x 130 cm • 2875385
» 208 cm x 130 cm • 2875860



FOLDING ALUMINUM ARCHED RAMP

- Ramp folds up for transport
 - Capacity up to 1361 kg
 - Safety straps included
- » 224 cm x 30.5 cm • 2875387

HITCHES

3:1 HITCHES VERSATILE 3 IN 1 FUNCTIONALITY

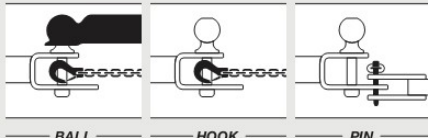

- Ball, pin and hook design
- Durable, rust resistant steel with black powdercoated finish
- Removable ball
- HD 1.6 cm pin and clip



HITCH WITH 5 cm BALL

- » 5 cm x 5 cm RECEIVER 2830522
- » 3 cm x 3 cm RECEIVER 2830523



4.8 cm BALL

- 4.8 cm replacement ball for hitch
 - Designed to work with 3:1 Hitch
- » 2830524



RECEIVER HITCH

- » 5 cm RECEIVER TONGUE 2875320
- » FRONT HITCH RECEIVER 2878846



TRAILER BALL AND SHANK

- » 4.8 cm BALL • 2877602
- » 5 cm BALL • 2877603

STRAPS & ROPES



RECOVERY STRAP

- 5 cm x 9.1 m (8165 kg)
 - Comes with carry bag
- » 2884033



RATCHET STRAP

- 3.8 cm x 4.6 m straps, 2 Pack
 - Heavy duty webbing
 - 2495 kg maximum load, 831 kg working load
- » 2884031



RATCHET STRAP

- 5 cm x 6.1 m Ratchet Straps
 - Heavy duty webbing, floating D-rings, double J-hooks
 - 4536 kg maximum load, 1497 kg working load
- » 2884032



SHOCK STRAPS

- 3.8 cm 1361 kg breaking strength
 - Keeps tension on tie-down straps to secure load, 2 Pack
- » 3.8 cm x 4.6 m • 2883296
» 3.8 cm x 2.1 m • 2883295



TRAILERABLE COVER

- » 2876614
ALL SPORTSMAN EXCEPT 300/400, XP 1000 S, SCRAMBLER XP 1000 S, X2, TOURING REPLACEMENT STRAP 2871912.

- » 2877999
ALL SPORTSMAN TOURING REPLACEMENT STRAP 2871912.

- » 2884188
XP 1000 S, SCRAMBLER XP 1000 S

RIDING GEAR



OFF-ROAD RIDING JERSEYS S-3XL

- Mesh ventilated panels for maximum airflow
- Elastic sleeves with non-restrictive cuffs

OFF-ROAD RIDING GLOVES S-3XL

- Adjustable wrist closure for a custom fit
- Silicon finger grips and neoprene knuckle protection



BLACK
JERSEY | 2860646
GLOVE | 2860641

BLUE/LIME
JERSEY | 2860647
GLOVE | 2860642

MULTICOLOR
JERSEY | 2860648
GLOVE | 2860643



NAVY/PINK
JERSEY | 2860649
GLOVE | 2860644

RED
JERSEY | 2860650
GLOVE | 2860645



YOUTH JERSEY
S-XL
MULTICOLOR | 2860652
BLUE | 2860651



COOLING SHIRTS

**MEN'S LONG SLEEVE
COOLING SHIRT**
S-3XL | 2860638

**WOMEN'S LONG SLEEVE
COOLING SHIRT**
S-3XL | 2860640



FABRIC TECHNOLOGY DESIGNED TO KEEP YOU COOL

Cooling fabric designed with sun protection in mind. Our chemical-free fabric Coolcore reduces the surface temperature on our cooling shirt up to 30%, so you don't overheat. It carries a 50 Ultraviolet Protection Factor rating, the highest attainable, blocking 98% of harmful UV rays.



SHORT SLEEVE COOLING SHIRTS

MEN'S
S-3XL | 2860634

WOMEN'S
S-3XL | 2860636

OUTERWEAR BUILT TO WORK HARD & PLAY HARD

RAIN SUIT



RAIN JACKET
GRAY
S-3XL | 2869527

RAIN PANTS
GRAY
S-3XL | 2869528

- 100% waterproof light weight and packable nylon
- YKK Zippers
- Rainjacket has removable hood

APPAREL & HELMETS

OUTERWEAR & PROTECTION

LIFESTYLE & CAPS

CAMO & GIFTS

HELMETS



RED/BLACK
XS-4XL
2861470



[ALTITUDE]



BLACK
XS-4XL
2861469



BLACK/RED
XS-4XL
2861472



CARBON FIBER
BLACK/LIME
XS-4XL | 2861473

NEW

509 ALTITUDE 2.0 HELMET

Lightweight Design, performance-infused style and features with all-day comfort

SHELL

- Strong, lightweight construction of carbon fiber or fiber glass

WEIGHT

- Composite as low as 1,260g
- Carbon fiber as low as 1,150g

FEATURES

- Superior fit for all-day comfort
- Removable Pro Series breath box provides excellent ventilation and air flow
- One-piece eye-port creates draft-free seal with 509 goggles
- Magnetic Fidlock chin-strap technology and integrated GoPro mount
- DOT- and ECE 22.05-approved



GOGGLES



BLACK
2868669

RED
2868670

LIME
2868671

BLUE
2868667

KINGPIN 509 DIRT GOGGLE



Premium Materials, attractive price

FEATURES

- Oversized spherical lens delivers optimal peripheral vision
- Metal tear off posts provide strength and durability
- Quick-change technology allows you to run the best lens tint for conditions



ORANGE
2868668



BLACK
XS-2XL
2861557



BLACK/GRAY
XS-2XL
2861558



BLACK/WHITE
XS-2XL
2861560



WHITE/RED
XS-2XL
2861561



PINK
XS-2XL
2861562

NEW
TENACITY 4.0 HELMET

Combination of modern style and premium protection with incredible value

SHELL

- Shock-resistant, injection-molded thermoplastic

WEIGHT

- 1,500g

FEATURES

- Through-flow, full-helmet ventilation
- ProClip quick release chin strap allows you to fasten the chin strap in seconds
- Removable breath box
- Tool-less adjustable roost shield
- Removable, washable liner
- DOT- and ECE 22.05-approved

TRAIL GOGGLE



Clear Vision at a Great Value

FEATURES

- Offers a distortion-free view with anti-scratch, anti-fog and UV-blocking technology
- Large lens opening enables greater peripheral vision



BLACK
2867917

OUTERWEAR



FORCE JACKET

WINDBREAKER JACKET

NEW
FORCE JACKET

Versatile, lightweight jacket ideal for layering or wearing as a casual jacket.

MEN'S | S-3XL | 2861432



WOMEN'S
S-3XL | 2861433

NEW
WINDBREAKER JACKET

Lightweight, windproof jacket that provides protection while riding.

- 100% polyester windproof fabric
- 3 external pockets allow for maximum storage

S-3XL | 2861541



FLANNEL JACKET
BRONZE
S-3XL | 2860864

WORK JACKET
FOREST GREEN
S-3XL | 2860862



CHARCOAL
S-3XL | 2860865



NEW
BLACK
S-3XL | 2861608

GRAY
S-3XL | 2860863

FLANNEL JACKET

This stylish flannel jacket is designed to keep you riding on brisk days. Soft yet durable brushed flannel with a Sherpa fleece lining offers excellent insulation without the bulkiness of a winter jacket.

WORK JACKET

This warm and rugged jacket was engineered to be tough enough for work yet stylish enough for play.

External features:

- Constructed of Nylon 6, a durable, tear-resistant non-stretch woven fabric
- Coated with Durable Water Repellency (DWR) to provide water-resistance in the elements
- Four external pockets for maximum gear storage

Internal features:

- 80 gram 3M Thinsulate for added warmth
- Built in action back for increased range of motion
- Internal zipper pocket
- Brushed flannel trim



GRAY/BLUE
S-3XL | 2861439

BLACK
S-3XL | 2861434

NEW
SOFTSHELL JACKET

Lightweight performance that's surprisingly warm and perfect for everyday wear

- DWR prevents precipitation from saturating the jacket's exterior
- Three external and one internal pocket
- Lined with 280 grams of soft fleece for warmth
- Removable hood and underarm venting



MAROON
S-3XL | 2861438

BLACK
S-3XL | 2861437

GRAY
S-3XL | 2861435

BLACK/BLUE
S-3XL | 2861436

WOMEN'S

MEN'S



LAYERING

TECH QUARTER ZIP
PINK
S-3XL | 2861448

NORTHSTAR MID LAYER
BLACK/GRAY
S-3XL | 2869925

NEW
TECH QUARTER ZIP

Excellent for ride layering, comfortable and stylish stand-alone.

WOMEN'S

MEN'S

NORTHSTAR MID LAYER

Breathable fleece mid-layer is perfect for adding warmth or as a stand-alone shirt.



BLACK
S-3XL | 2861447



BLUE
S-3XL | 2861443



BLACK
S-3XL | 2861442



NEW
BLACK/RED
S-3XL | 2861445

LIFESTYLE



NEW

MEN'S ICON HOODIE
S-3XL
BLACK | 2861496
GREEN | 2861495



NEW

WOMEN'S TECH HOODIE
S-3XL
GRAY | 2861508
MAROON | 2861509

NEW
MEN'S CREW SWEATSHIRT
S-3XL
GREEN | 2861498
NAVY | 2861497



NEW
WOMEN'S ICON HOODIE
S-3XL
MAROON | 2861507
BLACK/PINK | 2861506



NEW
MEN'S TECH HOODIE
S-3XL
BLACK/BLUE | 2861494
GRAY | 2861493



NEW
WOMEN'S CHECKERED HOODIE
S-3XL
BLACK | 2861609
BLUE | 2861610



HATS & T-SHIRTS



NEW
MEN'S ALL-IN TEE
 S-3XL
 BLACK | 2861574
 GRAY | 2861575



NEW
BADGE TRUCKER HAT
 One-Size
 GRAY | 2861531
 NAVY | 2861532
 BLACK | 2861533
 PINK | 2861549
 MAROON | 2861537



NEW
TONAL HAT
 L/XL
 BLACK | 2861526
 NAVY | 2861525



NEW
CORE HAT
 One-Size
 NAVY | 2861523
 BLACK | 2861524



NEW
CHECKERED HAT
 One-Size
 NAVY | 2861520
 GRAY | 2861521
 BLACK | 2861522



NEW
WOMEN'S ALL-IN TEE
 S-3XL
 BLACK | 2861598
 OLIVE | 2861599



NEW
MEN'S PERFORMANCE LONG SLEEVE
 S-3XL
 ROYAL | 2861589
 GRAY | 2861588



NEW
MEN'S BACK GRAPHIC TEE
 S-3XL
 GRAY | 2861568
 NAVY | 2861569



NEW
MEN'S STAMP TEE
 S-3XL
 GRAY | 2861565
 GREEN | 2861564



APPAREL & HELMETS

OUTERWEAR & PROTECTION

LIFESTYLE CAPS

CAMO & GIFTS

CAMO

NEW

STEALTH CAMO HAT
One-Size
CAMO | 2861527

NEW

NORTHSTAR MID LAYER
S-3XL
CAMO | 2861542

NEW

CAMO SOFTSHELL JACKET
S-3XL
CAMO | 2861543



CAMO POLY HOODIE
S-3XL
BLACK | 2860718



HUNTER CAMO HOODIE
S-3XL
OLIVE | 2868716
GRAY | 2860728



CAMO FULL ZIP
S-3XL
OLIVE | 2869590



MEN'S CAMO TEE
S-3XL
GRAY | 2860709
BLACK | 2860710



CAMO HOODIE
S-3XL
WOMEN'S | 2867898
MEN'S | 2867879



CAMO TRUCKER HAT
One-Size
BLACK | 2860613
PINK | 2860614

GIFTS & BRANDED MERCHANDISE

POLARIS STEEL SIGN (26.7 cm x 61 cm)
2860868

PINT GLASS (SET OF 2)
2860815

POLARIS WOODEN COASTERS WITH BOTTLE OPENER
2860869

DRINKWARE



PREMIUM COOZIE
2860829



NEW
17oz WATER BOTTLE
2861611



NEW
12oz CAMPER MUG
2861612



NEW
15oz CAMPFIRE MUG
2861613

RECREATION/GARAGE



NEW
EVENT FOLDING CHAIR
2861617



NEW
FOLDING TABLE
2861620



POLARIS WOOD SIGN
(26.7 cm x 61 cm)
2860866



NEW
NECK GAITERS
One-Size
CAMO | 2861948
BLACK | 2861953

COLLECTIBLES



NEW
KEYCHAIN
2861614



NEW
LEATHER KEYCHAIN
2861616



MINI SPORTSMAN TOY
2860821



BOTTLE OPENER
2860818

APPAREL & HELMETS

OUTWEAR & PROTECTION

LIFESTYLE & CAPS

CAMO & GIFTS

FORGE YOUR OWN PATH



Warning: Polaris off-road vehicles can be hazardous to operate and are not intended for on-road use. Driver must be at least 16 years old with a valid driver's license to operate. All riders should always wear helmets, eye protection and protective clothing and footwear. Read, understand and follow your owner's manual. Ride within the limits of your own abilities and never engage in stunt or exhibition driving. Never ride under the influence of drugs or alcohol. All riders should take a safety training course. Call 800-942-3764 for additional information.

UNLESS NOTED, TRADEMARKS ARE THE PROPERTY OF POLARIS INDUSTRIES INC. 3M® and Thinsulate® are registered trademarks of 3M Company. 505® is a registered trademark of Teton Outfitters, LLC. BatteryMinder® is a registered trademark of VDC Electronics Inc. Bluetooth® is a registered trademark of Bluetooth Sig. Inc. Browning® is a registered trademark of BROWNING INTERNATIONAL S.A. Caliber® is a registered trademark of Caliber, Inc. CAMSO® is a registered trademark of Arctic Investments S.A. CREE® is a registered trademark of Cree, Inc. COOLCORE® is a registered trademark of COOLCORE LLC. Fidlock® is a registered trademark of Fidlock GmbH. FOX® is a registered trademark of Fox Factory Inc. High Lifter® is a registered trademark of High Lifter Products, Inc. Kolpin® is a registered trademark of Polaris Industries, Inc. Mossy Oak® is a registered trademark of Mossy Outdoors, Inc. OGIO® is a registered trademark of Ogio International, Inc. Rigid® is a trademark of JST Performance, LLC d/b/a Rigid Industries, LLC. Rockford Fosgate® is a registered trademark of Rockford Corporation. TEKVEST® is a registered trademark of 1181676 ONTARIO INC. Tiger Drylac® is a registered trademark of TIGER COATINGS GMBH & CO. KG. Velcro® is a registered trademark of VELCRO BVA. Yeti® is a registered trademark of Yeti Coolers, LLC. YKK® is a registered trademark of YKK Corporation. YouTube® is a registered trademark of Google Inc. PRCES, FITMENT AND AVAILABILITY ARE SUBJECT TO CHANGE AT ANY MOMENT. COPYRIGHT © 2020 POLARIS INDUSTRIES INC. ALL RIGHTS RESERVED.

Accessories and gear availability is subject to local regulations. Accessories are not available in all countries. Some gear shown may not be available for riding purposes but for casual use only. Please carefully read the instructions on the products or contact your local dealer for more information prior any use of the products. Polaris Industries Inc. reserves the right, without prior notice, to discontinue at any time at its discretion any of the items herein or change specifications or designs without incurring any obligation to the customer. All items are subject to availability and prior sales by our dealers.

POLARIS

MY21 SPTSMN APP ACC EMEA