

EMEA VERSION

# POLARIS GENERAL

POP

ACCESSORIES + APPAREL



## ELEVATE YOUR ADVENTURE

OFF-ROAD'S PREMIER FAMILY OF ADVENTURE SIDE-BY-SIDES. No matter which GENERAL you choose, you begin every adventure with the best performance, the greatest utility, and the most comfortable ride you can get in a side-by-side. When you customize with Polaris Engineered Accessories you have the confidence to take on any task or any trail.



# BRING IT ALL. BRING IT ON.

Introducing all-new, industry-exclusive Rhino-Rack® storage solutions for GENERAL. Transform your vehicle for work, play or anything in between with durable and easy-to-use bed racks and load securing attachments.

# 2022 LINEUP

## GENERAL

### DELUXE (2 & 4 SEAT)



#### GENERAL 1000 DELUXE

##### PREMIUM PLUS:

FOX PODIUM X 2.0 QS3 SHOCKS  
SPORT ROOF  
STAGE 1 AUDIO SYSTEM BY ROCKFORD FOSGATE  
CONVEX REAR VIEW MIRROR

RIDE COMMAND WITH ROCKFORD FOSGATE  
STAGE 3 AUDIO MODEL AVAILABLE.

# CONTENTS

## ACCESSORIES

06

WINDSHIELDS & REAR PANELS.....	08
DOORS.....	10
ROOFS.....	12
VEHICLE & RIDER PROTECTION.....	13
STORAGE.....	14
CAB COMFORT.....	17
HUNT.....	18
POLARIS NORTHSTAR COOLERS.....	20
CONNECTED TECHNOLOGY.....	22
AUDIO.....	24
LIGHTING.....	26
WHEELS & TIRES.....	28
WINCHES.....	36
PLOWS & TRACKS.....	37

## PARTS & GARAGE

38

MAINTENANCE.....	38
OIL & LUBRICANTS.....	40
HO PARTS.....	42
SERVICE PARTS.....	44
CLEANERS & TRAILERING.....	46

## APPAREL

48

RACING COLLECTION.....	48
RIDING GEAR.....	50
HELMETS & GOGGLES.....	52
MEN'S APPAREL.....	54
WOMEN'S APPAREL.....	60
MERCHANDISE.....	62

**POLARIS**  
**ENGINEERED**

## DESIGNED



Designed by the same people who designed your vehicle.

## TESTED



Extensively tested in the field so you ride with 100% confidence.

## INTRODUCING OUR NEWEST PARTNER



**RHINO-RACK®**

Introducing an industry exclusive – Rhino-Rack® storage solutions designed specifically for Polaris GENERAL. From opposite sides of the globe, the most capable machines in the off-road world meet a trusted outdoor adventure brand to deliver industry-exclusive bed racks and accessories to help Polaris GENERAL users have more fun and get more done. Designed for perfect integration and tested to off-road standards, a Rhino-Rack-equipped GENERAL will help you get more storage capacity out of your machine – so you can stay prepared for whatever the day may bring.

**WE HOLD OUR PARTNERS TO THE SAME STANDARDS**

**PRO ARMOR** 

WHEELS, TIRES & LIGHTING DESIGNED WITH POLARIS TO MAXIMIZE PERFORMANCE  
P. 27 & 28

 **Rockford Fosgate**

A GLOBAL LEADER IN AUDIO INNOVATION, DESIGN & ENGINEERING  
P. 24

KEEP YOUR  
**STANDARDS**  
HIGH. WE DO.

# TRUSTED



65 years in the business.  
The #1 name in Off-Road.



**RIGID**

PRODUCTS SO GOOD THEY REPLACE  
OR REPAIR THEM FOR LIFE  
P. 26

**KOLPIN**  
OUTDOORS

MAKING PRODUCTS FOR AVID  
SPORTSMEN SINCE 1943  
P. 18

**NEW**  
**RHINO-RACK**

BRING IT ALL.  
BRING IT ON.  
P. 14

# ENGINEERED TO TAKE ON THE ELEMENTS

## TESTED & PROVEN



**BUILD YOUR CAB SYSTEM  
STARTING ON P. 08**



## COMFORT YOU HAVE TO EXPERIENCE TO BELIEVE

Our cab components create an experience enhancing interior, offering supreme comfort to your vehicle.



**POLARIS ENGINEERED  
ADVANTAGES**

**PROFILE  
TUBE DESIGN**

Contours built into the cage deliver a premium sealing surface.



**PERFECT FIT,  
PERFECT SEAL**

A 360° gasket seal provides our tightest-sealing cab.



**LOCK & RIDE  
EASY ON & OFF**

Adapt to your needs and environment with exclusive tool-less, easy-on, easy-off Lock & Ride components.

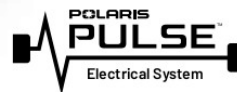

**PLUG & PLAY  
ELECTRICAL**

**EFFORTLESSLY ADD  
LIGHTS, HEAT, WIPERS & AUDIO.**

A revolution in electrical accessory integration, the Polaris PULSE Electrical System allows for a simple plug & play approach for adding power to Polaris Engineered Accessories.

Look for  to identify Polaris PULSE ready accessories.





# ELEVATE

YOUR ADVENTURE

- LOCK & RIDE** Vented Windshield - Hard Coat Poly: P. 08
- Windshield Wiper & Washer System: P. 08
- Rear Sport Bumper: P. 13
- Extreme Kick-Out Rock Sliders: P. 13
- Rhino-Rack Rear Bed Rack: P. 14
- Polaris Northstar 14 L Cooler: P. 20
- Pro Armor 83 cm Combo LED Light Bar: P. 27
- Light Bar Harness: P. 27



# BLAZE A NEW

# TRAIL

- LOCK & RIDE** Vented Windshield - Hard Coat Poly: P. 08
- Sport Roof - Poly: P. 12
- XL Fender Flares: P. 13 **NOT SHOWN**
- LOCK & RIDE** Cargo Box: P. 14
- RIGID SR-Series Combo Light Bar: P. 27
- Pro Armor Wheel & Tire Set: P. 35
- 29" Mud XC 6 14" 4204 - Matte Black
- Winch: P. 36





# PREPARE FOR THE HUNT

- NOT SHOWN** **LOCK & RIDE** Full Windshield - Glass: P. 08
- NOT SHOWN** Windshield Wiper & Washer System: P. 08
- LOCK & RIDE** Rear Panel - Glass: P. 09
- NOT SHOWN** Polaris PULSE LED Light Bar Harness: P. 17
- NOT SHOWN** Pro Armor 83 cm Combo LED Light Bar: P. 27

In addition to stock accessories



# SPORT ESSENTIALS

- LOCK & RIDE** Full Windshield - Glass: P. 08
- Windshield Wiper & Washer System: P. 08
- LOCK & RIDE** Rear Panel - Glass: P. 09
- Premium Roof - Poly: P. 12
- Polaris Northstar 28 L Cooler: P. 20

# WINDSHIELDS

Keep the elements out and control air flow into the cab.

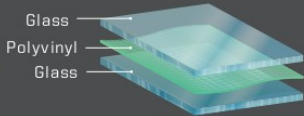

## GLASS VS POLY

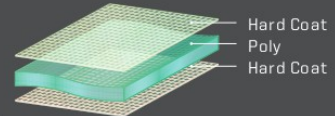

- Superior optical clarity (automotive level)
- Scratch-resistant
- Curved to fit, seals tight
- Cold weather / heavy duty
- Wiper ready (windshield only)

- Lightweight, flexible, easy to store/remove
- Impact-resistant
- Tight seal keeps out rain and dust
- Hard Coat: 30x more scratch resistance than regular poly windshields

### GLASS

### HARD COAT POLY

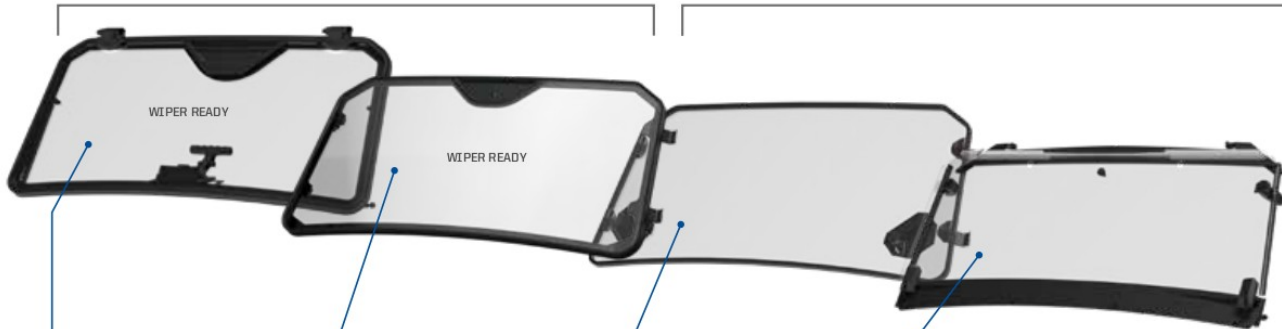

#### TIP-OUT WINDSHIELD - GLASS TOP SELLER

» 2881108  
POLARIS GENERAL XP 1000/4 '20-22  
POLARIS GENERAL 1000/4 '16-22

#### LOCK & RIDE FULL WINDSHIELD - GLASS TOP SELLER

» 2889064  
POLARIS GENERAL XP 1000/4 '20-22  
POLARIS GENERAL 1000/4 '16-22

#### LOCK & RIDE VENTED WINDSHIELD - HARD COAT POLY

» 2884223  
POLARIS GENERAL XP 1000/4 '20-22  
POLARIS GENERAL 1000/4 '16-22

#### FLIP-DOWN WINDSHIELD - HARD COAT POLY

» 2889156  
POLARIS GENERAL XP 1000/4 '20-22  
POLARIS GENERAL 1000/4 '16-22



#### WINDSHIELD WIPER & WASHER SYSTEM TOP SELLER

» 2881090  
POLARIS GENERAL XP 1000/4 '20-22  
POLARIS GENERAL 1000/4 '16-22



Offers fully-sealed or flipped-down venting options. Upper half detaches, leaving lower half for protection with maximum ventilation.



## ADD A REAR PANEL TO REDUCE THE DUST SWIRL

# REAR PANELS

Turbulent air forms above the cargo bed and behind the cab when you add a windshield. This swirl can carry dirt, dust, leaves, and rain into the cab. Eliminate this phenomenon and **control the swirl** by installing a rear panel.

POLARIS ENGINEERED  
ADVANTAGES



**LOCK & RIDE**  
REVOLUTIONARY  
INSTALLATION



**AIR TIGHT  
GASKET SEAL**

ACCESSORIES

WINDSHIELDS &  
REAR PANELS

POLY

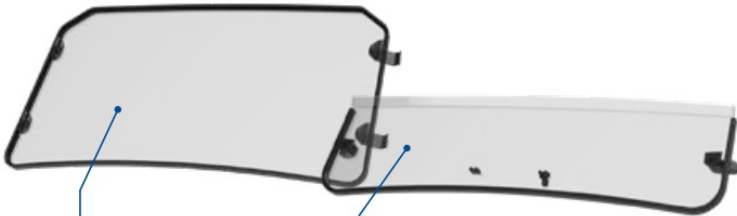

**LOCK & RIDE**  
FULL WINDSHIELD -  
HARD COAT POLY

» 2884337  
POLARIS GENERAL XP 1000/4 '20-22  
POLARIS GENERAL 1000/4 '16-22

**LOCK & RIDE**  
HALF WINDSHIELD -  
POLY

» 2881111  
POLARIS GENERAL XP 1000/4 '20-22  
POLARIS GENERAL 1000/4 '16-22



DOORS

ROOFS &  
PROTECTION

STORAGE, CAB  
COMFORT & HUNT

COOLERS

CONNECTED  
TECHNOLOGY & AUDIO

LIGHTING

WHEELS & TIRES

WINCHES, PLOWS  
& TRACKS



**LOCK & RIDE**  
REAR PANEL - GLASS **TOP SELLER**

» 2881113  
POLARIS GENERAL XP 1000/4 '20-22  
POLARIS GENERAL 1000/4 '16-22



**LOCK & RIDE**  
REAR PANEL - POLY **TOP SELLER**

» 2881112  
POLARIS GENERAL XP 1000/4 '20-22  
POLARIS GENERAL 1000/4 '16-22

# DOORS

**COMPLETE YOUR CAB.** POLARIS GENERAL comes equipped with half doors. To create an enclosed cab for increased protection from the elements, choose from two great Polaris options.



## REPLACE STOCK HALF DOORS

### PREMIUM POLY FULL DOORS

- Impact and scratch-resistant tempered glass
- Fully-sealed design keeps elements out for a premium in-cab environment
- Hinged window adjustability
- Soft-touch, easy-to-clean premium interior liner

#### 2-SEAT

- Six-way glass window adjustability

» 2883717

POLARIS GENERAL XP 1000/4 '20-22  
POLARIS GENERAL 1000/4 '16-22

#### 4-SEAT

- Push-out windows
- Kit includes B-pillar cover seal

» 2883082

POLARIS GENERAL XP 4 1000 '20-22  
POLARIS GENERAL 4 1000 '17-22



POLARIS ENGINEERED ADVANTAGES



PREMIUM INTERIOR HANDLE AND LINER



A PERFECT FIT FOR THE PERFECT SEAL



**ADD UPPER DOORS TO STOCK HALF DOORS**

**ZIP WINDOW UPPER DOORS**

- Durable, rugged canvas stitched over a robust steel frame
- Lightweight, UV-resistant construction
- Retention straps for increased strength
- Zipper windows for increased venting options
- Mounts easily by drilling into stock doors (drill hole plugs included)

**2-SEAT**

- » 2882548  
POLARIS GENERAL XP 1000 '20-'22  
POLARIS GENERAL 1000 '18-'22

NOT SHOWN

**4-SEAT**

- » 2883453  
POLARIS GENERAL XP 4 1000 '20-'22  
POLARIS GENERAL 4 1000 '18-'22

**SEE P. 14 FOR THE NEW RHINO-RACK STORAGE SOLUTIONS**



# ROOFS

Protect yourself from the elements. The right roof shields you from the sun and driving rain.

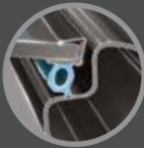

**A PERFECT FIT FOR THE PERFECT SEAL**



**PREMIUM FEATURES & QUIETER RIDE**



**KEEP MOISTURE MOVING**

**POLARIS ENGINEERED ADVANTAGES**

## ALUMINUM vs POLY

- High protection strength
- Lower profile
- Sleek style
- Water run-off
- Pre-existing mounting features
- Liner ready
- Lightweight

### 2-SEAT

#### ROOF - ALUMINUM

» 2881105  
POLARIS GENERAL XP 1000 '20-22  
POLARIS GENERAL 1000 '16-22



#### PREMIUM ROOF - POLY

» 2883800  
POLARIS GENERAL XP 1000 '20-22  
POLARIS GENERAL 1000 '16-22



INCLUDES PREMIUM ROOF LINER

#### TOP SELLER SPORT ROOF - POLY

» 2883780  
POLARIS GENERAL XP 1000 '20-22  
POLARIS GENERAL 1000 '16-22



### 4-SEAT

#### PREMIUM ROOF - POLY

» 2883801  
POLARIS GENERAL XP 4 1000 '20-22  
POLARIS GENERAL 4 1000 '17-22



INCLUDES PREMIUM ROOF LINER

#### TOP SELLER SPORT ROOF - POLY

» 2883781  
POLARIS GENERAL XP 4 1000 '20-22  
POLARIS GENERAL 4 1000 '17-22



#### POLY ROOF LINER

» 2883802  
POLARIS GENERAL XP 4 1000 '20-22  
POLARIS GENERAL 4 1000 '17-22  
Compatible with Sport Roof - Poly (2883781), sold separately



# VEHICLE & RIDER PROTECTION

Arm your POLARIS GENERAL with Polaris Engineered bumpers and guards to take on any challenge. Engineered for easy, secure installation; providing added protection for lights, bodywork and suspension.



## ROCK SLIDERS NOT SHOWN

### LOW PROFILE

- » **2881102**  
POLARIS GENERAL 1000 '16-22  
Not compatible with XL Fender Flares

### EXTREME KICK-OUT

- » **2-SEAT • 2881101**  
POLARIS GENERAL XP 1000 '20-22  
POLARIS GENERAL 1000 '16-22
- » **4-SEAT • 2881992**  
POLARIS GENERAL XP 4 1000 '20-22  
POLARIS GENERAL 4 1000 '17-22

## XL FENDER FLARES

- » **2884220**  
POLARIS GENERAL 1000/4 '16-22  
Not compatible with Low Profile Rock Sliders  
Standard on GENERAL XP models

## HMW A-ARM GUARDS NOT SHOWN

- » **FRONT • 2880274**  
POLARIS GENERAL XP 1000/4 '20-22  
POLARIS GENERAL 1000/4 '16-22
- » **REAR • 2880171**  
POLARIS GENERAL 1000 '16-22

## HIGH CLEARANCE A-ARM GUARDS

- » **FRONT • 2884221**  
POLARIS GENERAL XP 1000/4 '20-22
- » **REAR • 2884222**  
POLARIS GENERAL XP 1000/4 '20-22

## REAR SPORT BUMPER NOT SHOWN

- » **2884345**  
POLARIS GENERAL XP 1000/4 '20-22  
POLARIS GENERAL 1000/4 '16-22

## FRONT BUMPERS

- A** **SPORT LOW PROFILE** TOP SELLER  
» **2881094**  
POLARIS GENERAL XP 1000/4 '20-22  
POLARIS GENERAL 1000/4 '16-22
- B** **SPORT UPPER**  
» **2881525**  
POLARIS GENERAL XP 1000/4 '20-22  
POLARIS GENERAL 1000/4 '16-22  
Requires Sport Low Profile Front Bumper



## EXPANSION ANCHOR MOUNTS

TOUGH EXPANSION ANCHOR MOUNTS DESIGNED FOR POLARIS GENERAL ALLOW FOR QUICK INSTALL OF ROCK SLIDERS AND BUMPERS WITHOUT DAMAGING THE VEHICLE'S FRAME.



ACCESSORIES

WINDSHIELDS & REAR PANELS

DOORS

ROOFS & PROTECTION

STORAGE, CAB COMFORT & HUNT

COOLERS

CONNECTED TECHNOLOGY & AUDIO

LIGHTING

WHEELS & TIRES

WINCHES, PLOWS & TRACKS

# STORAGE



**RHINO-RACK®**

## BRING IT ALL. BRING IT ON.

From opposite sides of the globe, the most capable machines in the off-road world meet a trusted outdoor adventure brand to deliver industry-exclusive purpose-built bed racks and accessories to help Polaris GENERAL users have more fun and get more done. Increase storage capacity so you can go where you want with everything you need, organized to succeed.



### REAR BED RACK



**LOCK & RIDE**   
**REAR BED RACK**

- The ultimate modular load carrying solution
- Strong, lightweight aluminum construction tested in the harshest conditions
- Quickly adapt your vehicle from workday to weekend with a wide array of Rhino-Rack attachments

» 2889443

POLARIS GENERAL XP 1000/4 '20-22  
POLARIS GENERAL 1000/4 '16-22

### ATTACHMENTS



**NEW**  
**GUN MOUNTING BRACKET**

- Bracket used to mount Kolpin Stronghold Gun Boots to Rhino-Rack® systems when paired with Auto-Latch Mount (2884106), sold separately

» 2889327

POLARIS GENERAL XP 1000/4 '20-22  
POLARIS GENERAL 1000/4 '16-22

See P. 18 for more hunt information



**NEW**  
**EYELET TIE-DOWNS**

- Includes one set and hardware (straps not included) and attaches in multiple places on the platform to use as additional tie-down points
- Anti-corrosive galvanized steel for heavy-duty strength and long life

» 2889527

POLARIS GENERAL XP 1000/4 '20-22  
POLARIS GENERAL 1000/4 '16-22



**NEW**  
**MULTI-PURPOSE TOOL HOLDER**

- Carry and protect tools, paddles and more during your ride
- Ratchet-locking mechanism for quick release with rubber inserts to secure accessories into place

» 2889528

POLARIS GENERAL XP 1000/4 '20-22  
POLARIS GENERAL 1000/4 '16-22





**NEW**  
**TRACTION BOARD MOUNT**

- Strong, durable and easy to attach mount
- Traction board not included

» **2889530**  
POLARIS GENERAL XP 1000/4 '20-22  
POLARIS GENERAL 1000/4 '16-22



**NEW**  
**CARGO CORNER BRACKET**

- Bring a Northstar cooler or toolbox while saving space inside your vehicle
- Unique anti-rotation nut for maximum cargo security

» **2889531**  
POLARIS GENERAL XP 1000/4 '20-22  
POLARIS GENERAL 1000/4 '16-22



**NEW**  
**HIGH LIFTING JACK MOUNT**

- Installs simply and quickly with durable brackets
- Rugged, non-corrosive powder-coated steel stands up to the harshest conditions

» **2889533**  
POLARIS GENERAL XP 1000/4 '20-22  
POLARIS GENERAL 1000/4 '16-22

# STORAGE

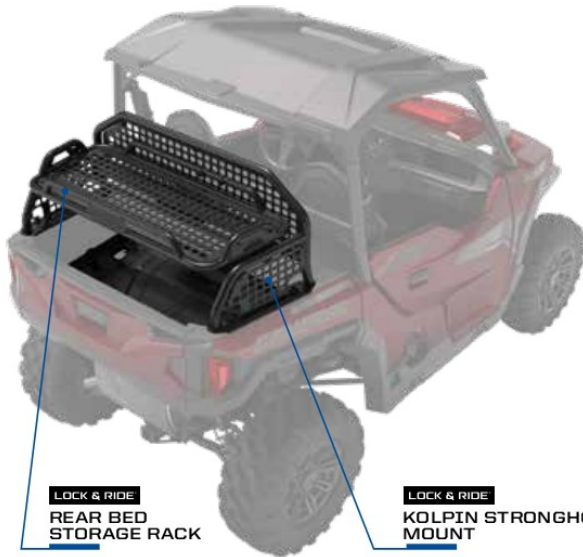

**LOCK & RIDE**  
**REAR BED STORAGE RACK**

» 2885113  
POLARIS GENERAL XP 1000/4 '20-22  
POLARIS GENERAL 1000/4 '16-22  
See P. 18 for more info

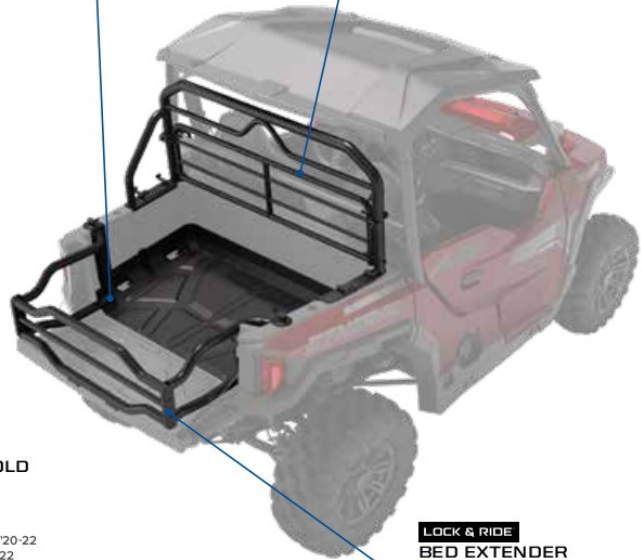

**CARGO BED MAT**

» 2881933  
POLARIS GENERAL XP 1000/4 '20-22  
POLARIS GENERAL 1000/4 '16-22

**LOCK & RIDE**  
**TIP-DOWN HEADACHE RACK**

» 2882144  
POLARIS GENERAL XP 1000/4 '20-22  
POLARIS GENERAL 1000/4 '16-22

**LOCK & RIDE**  
**KOLPIN STRONGHOLD MOUNT**

» 2885114  
POLARIS GENERAL XP 1000/4 '20-22  
POLARIS GENERAL 1000/4 '16-22  
See P. 18 for more info

**LOCK & RIDE**  
**BED EXTENDER**

» 2881547  
POLARIS GENERAL XP 1000/4 '20-22  
POLARIS GENERAL 1000/4 '16-22



**LOCK & RIDE**  
**SPARE TIRE CARRIER**

» 2885122  
POLARIS GENERAL XP 1000/4 '20-22  
POLARIS GENERAL 1000/4 '16-22  
FITS WHEEL UP TO 30"



**BEHIND SEAT STORAGE BAG**

» 2882164  
POLARIS GENERAL XP 1000/4 '20-22  
POLARIS GENERAL 1000/4 '16-22



**IN-DASH STORAGE BAG**

» 2882165  
POLARIS GENERAL XP 1000/4 '20-22  
POLARIS GENERAL 1000/4 '16-22



**EASILY RECONFIGURE FOR ANY TASK OR ANY TRAIL**

**LOCK & RIDE**  
**CARGO BOX**

» 2881527  
POLARIS GENERAL XP 1000/4 '20-22  
POLARIS GENERAL 1000/4 '16-22  
Includes all mounting hardware for secure installation

**LOCK & RIDE**  
**D-RINGS** TOP SELLER

» 2881545  
POLARIS GENERAL XP 1000/4 '20-22  
POLARIS GENERAL 1000/4 '16-22



**FIRE EXTINGUISHER HOLDER** NOT SHOWN

» 2882158  
POLARIS GENERAL XP 1000/4 '20-22  
POLARIS GENERAL 1000/4 '16-22  
Fits most 8.25 cm fire extinguishers (not included)

# CAB COMFORT

ACCESSORIES



## 8-VENT HEATER AND DEFROST SYSTEM TOP SELLER



» 2881316

POLARIS GENERAL XP 1000/4 '20-22  
POLARIS GENERAL 1000/4 '16-22

Not Compatible with Rockford Fosgate Stage 4 Audio Kits  
Audio Bracket (2885112) required to install heater on vehicles with RIDE COMMAND and audio, sold separately



## WINDSHIELD WIPER AND WASHER SYSTEM TOP SELLER



» 2881090

POLARIS GENERAL XP 1000/4 '20-22  
POLARIS GENERAL 1000/4 '16-22

SEE P. 08 FOR WINDSHIELDS

WINDSHIELDS & REAR PANELS

DOORS



## CONVEX REAR VIEW MIRROR

» 2881540

POLARIS GENERAL XP 1000/4 '20-22  
POLARIS GENERAL 1000/4 '16-22



## FLOOR MATS

» 2881934

POLARIS GENERAL XP 1000/4 '20-22  
POLARIS GENERAL 1000/4 '16-22

ROOFS & PROTECTION

STORAGE, CAB COMFORT & HUNT



- Red light is great for reading maps
- Green light is perfect for navigating in the dark
- Blue light is ideal for night riding

## MULTI-FUNCTION CAB LIGHT



- LED dome light provides white, red, green and blue lighting options
- Battery-operated, recharges when vehicle is on
- Remove to use as flashlight in and around vehicle

» 2884047

POLARIS GENERAL XP 1000/4 '20-22  
POLARIS GENERAL 1000/4 '19-22

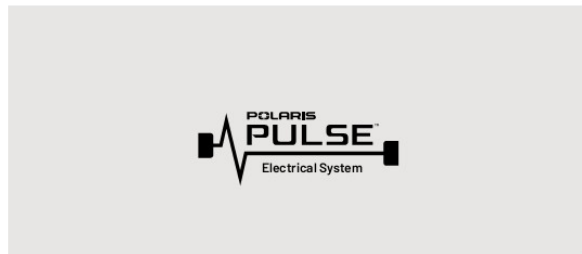

TOP SELLER

## POLARIS PULSE LED LIGHT BAR HARNESS



- Required to easily add electric components

» 2883785

POLARIS GENERAL XP 1000/4 '20-22  
POLARIS GENERAL 1000/4 '19-22

COOLERS

CONNECTED TECHNOLOGY & AUDIO

LIGHTING

WHEELS & TIRES

## POLARIS ENGINEERED ADVANTAGES



## ELECTRICAL INSTALLS

# MADE EASY WITH **PLUG & PLAY**



Look for to identify Polaris PULSE ready accessories.

- To install accessories, simply plug the harness into the Polaris PULSE hub
- No need to remove nuts and stack wire terminals like a three-post terminal setup
- By plugging in your accessories, a secure connection is guaranteed every time

WINCHES, PLOWS & TRACKS

# HUNT



## PROTECTING YOUR ESSENTIAL GEAR SINCE 1943

### KOLPIN STRONGHOLD CASES & MOUNT



**KOLPIN STRONGHOLD  
GUN BOOT XL**

- Includes zippered internal liner
- Lockable

» 2882036\*

POLARIS GENERAL XP 1000/4 '20-22  
POLARIS GENERAL 1000/4 '16-22



**KOLPIN STRONGHOLD  
GUN BOOT L**

» 2882426\*

POLARIS GENERAL XP 1000/4 '20-22  
POLARIS GENERAL 1000/4 '16-22



**KOLPIN STRONGHOLD  
AUTO-LATCH MOUNT**

» 2884106

POLARIS GENERAL XP 1000/4 '20-22  
POLARIS GENERAL 1000/4 '16-22



**KOLPIN STRONGHOLD  
AUTO-LATCH DOUBLE  
GUN BOOT MOUNT**

» 2883970

POLARIS GENERAL XP 1000/4 '20-22  
POLARIS GENERAL 1000/4 '16-22

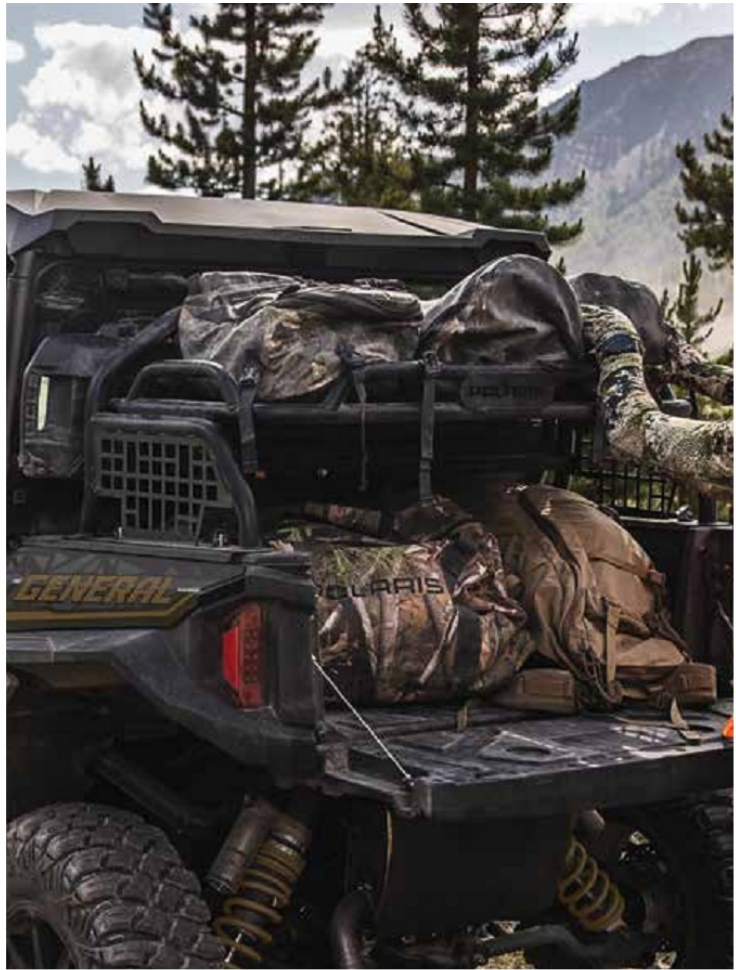

ACCESSORIES

WINDSHIELDS & REAR PANELS

DOORS

ROOF & PROTECTION

STORAGE, CAB COMFORT & HUNT

**STORAGE**

**LOCK & RIDE**

**REAR BED STORAGE RACK**

- Take more gear with integrated MOLLE panels and Lock & Ride installation
- 28 L or 57 L Polaris coolers will still fit in bed with rack installed
- Compatible with (1) Kolpin Stronghold Mount

» 2885113

POLARIS GENERAL XP 1000/4 '20-22  
POLARIS GENERAL 1000/4 '16-22

**LOCK & RIDE**

**KOLPIN STRONGHOLD MOUNT**

- Kolpin Stronghold mount for attaching gun boots or other Kolpin Stronghold items to a General Rear Bed Storage Rack

» 2885114

POLARIS GENERAL XP 1000/4 '20-22  
POLARIS GENERAL 1000/4 '16-22

Never transport a loaded firearm. Verify firearm is unloaded prior to mounting. Please refer to local laws and regulations regarding the requirements for the legal transport of firearms.

**RHINO-RACK MOUNT**      **KOLPIN RHINO GRIPS**      IDEAL FOR BOWS & UNCASSED GUNS



**NEW**

**GUN MOUNTING BRACKET**

- Bracket used to mount Kolpin Stronghold Gun Boots to Rhino-Rack systems when paired with Auto-Latch Mount (2884106), sold separately

» 2889327

POLARIS GENERAL XP 1000/4 '20-22  
POLARIS GENERAL 1000/4 '16-22

See P. 14 for more Rhino-Rack products



**LOCK & RIDE**

**RHINO GRIP PRO**

» 2884107

POLARIS GENERAL XP 1000/4 '20-22  
POLARIS GENERAL 1000/4 '16-22



**NEW**

**LOCK & RIDE**

**RHINO GRIP XLR**

» 2881574 • SINGLE

POLARIS GENERAL XP 1000/4 '20-22  
POLARIS GENERAL 1000/4 '16-22



**RHINO GRIP XLR REPLACEMENT RUBBER STRAPS (2)**

» 2889204

POLARIS GENERAL XP 1000/4 '20-22,  
POLARIS GENERAL 1000/4 '16-22



**LOCK & RIDE**

**RATCHETING RHINO GRIP**

» 2881575

POLARIS GENERAL XP 1000/4 '20-22  
POLARIS GENERAL 1000/4 '16-22



**NEW**

**LOCK & RIDE**

**RHINO GRIP XLR - DOUBLES**

» 2889166

POLARIS GENERAL XP 1000/4 '20-22  
POLARIS GENERAL 1000/4 '16-22



**RHINO GRIP PRO REPLACEMENT RUBBER STRAPS (2)**

» 2884109

POLARIS GENERAL XP 1000/4 '20-22,  
POLARIS GENERAL 1000/4 '16-22

COOLERS

CONNECTED TECHNOLOGY & AUDIO

LIGHTING

WHEELS & TIRES

WINCHES, PLOWS & RACKS

**POLARIS**  
**NORTHSTAR**  
**COOLER**

KEEP IT  
**ICE COLD**

**28, 57 & 99 LITER FEATURES**

- ComfortCarry Handles
- TravelLock System
- EasyOut Drain System
- NoSlip Rubber Feet
- PolarWall Insulation
- IceLock Seal



**99 LITER**

- » GRAPHITE • 2883426
- » DESERT • 2883392



**57 LITER**

- » GRAPHITE • 2883425
- » DESERT • 2881259



**28 LITER**

- » GRAPHITE • 2883424
- » DESERT • 2881315

**ESSENTIAL ACCESSORIES SO YOUR COOLER WORKS AS HARD AS YOU DO**

COOLER ACCESSORIES		99 LITER	57 LITER	28 LITER
	<b>WIRE BASKET</b>	2883648	2882185	2882438
	<b>DIVIDERS</b> Doubles as cutting board	2883468 COMES WITH ONE DIVIDER 	2882184 COMES WITH TWO DIVIDERS 	2882186 COMES WITH ONE DIVIDER 
	<b>SEAT CUSHION</b>	NOT AVAILABLE	2882179	2882507
	<b>WHEELS</b>	2883967	2882180	NOT AVAILABLE

# GRIZZLY TESTED.

## POLARIS APPROVED.



This cooler is IGBC-approved, meaning it withstands the power expended by a typical grizzly bear if it was trying to get inside.

Seriously, there are experts who know what a grizzly is capable of doing, and they certify our coolers can take it.



**POLARIS NORTHSTAR COOLERS CAN SURVIVE JUST ABOUT ANYTHING - FROM EXTREME HEAT TO A NASTY TUMBLE OFF A VEHICLE.**



**14 LITER**

» GRAPHITE • 2883968



**NEW**

**19 LITER SOFT-SIDED COOLER**

» GRAPHITE • 2889285

### DON'T FORGET THESE ACCESSORIES



887 mL

**TUMBLERS**

» 887 mL • 2883394  
» 591 mL • 2883393



**LOCK & RIDE  
QUICKSTRAP**

» 2882187  
ALL COOLERS AND  
POLARIS GENERAL CARGO  
BOXES



**BOTTLE OPENER**

» 2882183  
ALL COOLERS

ACCESSORIES

WINDSHIELDS &  
REAR PANELS

DOORS

ROOFS &  
PROTECTION

STORAGE, CAB  
COMFORT & HUNT

COOLERS

CONNECTED  
TECHNOLOGY & AUDIO

LIGHTING

WHEELS & TIRES

WINCHES, PLOWS  
& TRACKS

# CONNECTED TECHNOLOGY

## POLARIS RIDECOMMAND



## PLAN. TRACK. SHARE. CONNECT.

### PLAN YOUR RIDE

Plan an epic ride with stops along the way, customize and adjust your path to maximize your route. You can even share your planned route with friends.

### DISCOVER NEW TRAILS

With almost 1,000,000 miles of trails available offline, you'll have the confidence to explore further, whether you have cellular coverage or not.

### RELIVE YOUR RIDE

With 3D flyovers you can track and go over your completed rides, and share your favorite routes with friends even after the ride is over.





**7" DISPLAY POWERED BY RIDE COMMAND**



- **Bright, 7" touchscreen** visible in all conditions
- **Pre-Loaded Maps**  
Available offline on the in-dash display so you always know where you are.
- **Route Planning**  
Add points of interest and waypoints to make the most of your off-road adventure.
- **Camera Integration**  
Navigate with full view of your surroundings. Use the integrated rear camera to see others behind you while riding.
- **Personalized Audio Experience**  
Seamlessly pair your display via Bluetooth to wirelessly stream music and stay connected with call and text alerts.
- **Configurable Gauges**  
Customize your ride experience with elevation, travel direction, fuel level and more to create relevant screens for you.

» 2884072  
POLARIS GENERAL XP 1000/4 '20-'22  
POLARIS GENERAL 1000/4 '19-'22

**7" DISPLAY MOUNT KIT**



- Mount RIDE COMMAND seamlessly into the dash for perfect fit and finish
- Comes with required wiring harnesses and accessory components
- Includes front and rear camera, V2V and GPS antenna
- » 2889338  
POLARIS GENERAL XP 1000/4 '20-'22  
POLARIS GENERAL 1000/4 '20-'22  
WHEN REPLACING FACTORY IN-DASH AUDIO: EITHER AMP (2414533) AND RELOCATION KIT (2885112), BOTH REQUIRED SOLD SEPARATELY -OR- STAGE 3 RIDE COMMAND AUDIO KIT & REAR SPEAKERS (2885163), SOLD SEPARATELY, ARE REQUIRED

**AUDIO BRACKET**

- Used to mount an audio amplifier for front and rear speakers when subwoofer is removed
- Required to install a heater on a vehicle with RIDE COMMAND and audio
- » 2885112  
POLARIS GENERAL XP 1000/4 '20-'22  
POLARIS GENERAL 1000/4 '20-'22

# AUDIO



PLUG AND PLAY



ELEMENT READY\*



NO LOSS OF CARGO SPACE



BLUETOOTH CAPABLE

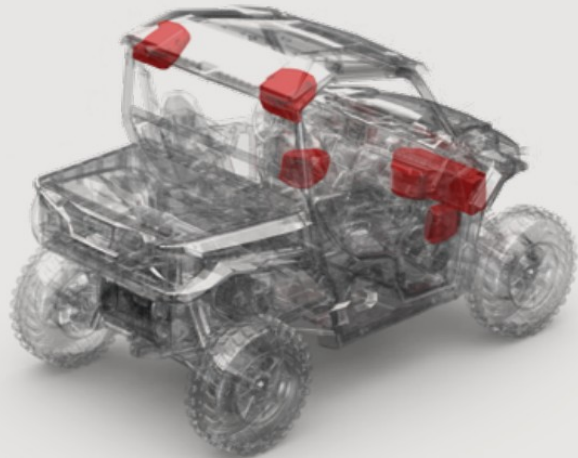

An industry first. A true factory installed integrated off-road audio system. Rockford Fosgate partnered with Polaris to purpose build the highest performing system specifically for the GENERAL platform. Tuned and rider-centric to create a class leading audio experience that is second to none.



**TOP SELLER**  
**STAGE 1 AUDIO KIT**



- PMX-P2 HEAD UNIT & FRONT COAXIAL SPEAKERS & ANTENNA
  - 6.86 cm full color display with AM/FM/WB tuner, Pandora Control and Bluetooth Connectivity\*
  - 50 Watt 16.51 cm front coaxial speakers with enclosures and grilles
- » 2884282  
POLARIS GENERAL XP 1000/4 '20-22  
POLARIS GENERAL 1000/4 '20-22



**STAGE 3 PMX AUDIO KIT + REAR SPEAKERS**



- REAR COAXIAL SPEAKERS & AMP
  - 2,50 Watt 16.51 cm rear coaxial speakers with enclosures and grilles
  - 400 Watt 4-channel full range amplifier
  - IP67 Rating delivering water resistance and dust protection
- » 2885162  
POLARIS GENERAL XP 1000/4 '20-22  
POLARIS GENERAL 1000/4 '16-22



**TOP SELLER**  
**STAGE 3 RIDE COMMAND AUDIO KIT + REAR SPEAKERS**



- FRONT & REAR COAXIAL SPEAKERS, ANTENNA & AMP
  - 2,50 Watt 16.51 cm front and rear coaxial speakers with enclosures and grilles
  - 400 Watt 4-channel full range amplifier
  - IP67 Rating delivering water resistance and dust protection
- » 2885163  
POLARIS GENERAL XP 1000/4 '20-22  
POLARIS GENERAL 1000/4 '16-22  
REQUIRES 7" DISPLAY WITH RIDE COMMAND (2884072) & 7" DISPLAY MOUNT KIT (2884283), BOTH SOLD SEPARATELY



**NEW**  
**STAGE 4 UPGRADE**



- POWERED SUBWOOFER
  - Compatible with Stage 1 and Stage 2 PMX-P2 Audio Kits
  - 400 Watt 25.4 cm subwoofer
  - Compatible with Stage 1 and Stage 3 Audio Kits
- » 2889306  
POLARIS GENERAL XP 1000/4 '20-22  
POLARIS GENERAL 1000/4 '16-22  
NOT COMPATIBLE WITH HEATER KIT (2881316)



## BUILD YOUR SOUND

HEAD UNIT:		<b>PMX-P2</b>		<b>RIDE COMMAND</b>	
AUDIO:		<b>STAGE 1 AUDIO KIT</b>	<b>STAGE 3 + 4 UPGRADES</b>	<b>STAGE 3 RIDE COMMAND AUDIO KIT</b>	
MODEL FITMENT:					
<b>XP</b>		<b>STAGE 1 AUDIO KIT WITH PMX-P2 HEAD UNIT INSTALLED</b>	<b>STAGE 3 + REAR SPEAKERS UPGRADE</b> REAR SPEAKERS, AMP + AUDIO BRACKET 2885162	<b>RIDE COMMAND + STAGE 3 AUDIO SYSTEM BY ROCKFORD FOSGATE MODEL INSTALLED</b>	
<b>DELUXE</b>			<b>OPTIONAL SUBWOOFER</b>	<small>TO ADD 8-VENT HEATER &amp; DEFROST SYSTEM (2881316), SUBWOOFER MUST BE REMOVED AND AMP RELOCATION BRACKET (2885112) MUST BE INSTALLED</small>	
<b>PREMIUM</b>		<b>STAGE 1 AUDIO KIT</b> PMX HEAD UNIT + FRONT COAXIAL SPEAKERS + ANTENNA 2884282	<b>STAGE 4 UPGRADE SUBWOOFER</b> 2889306 <small>NOT COMPATIBLE WITH 8-VENT HEATER &amp; DEFROST SYSTEM (2881316)</small>	<b>7" DISPLAY WITH RIDE COMMAND</b> 2884072	
<b>SPORT</b>				<b>7" DISPLAY MOUNT KIT</b> 2889338 <small>2020-2022 MODELS</small>	
				<b>STAGE 3 UPGRADE</b> REAR SPEAKERS, AMP + AUDIO BRACKET 2885163	
				<b>STAGE 4 UPGRADE SUBWOOFER</b> 2889306 <small>NOT COMPATIBLE WITH 8-VENT HEATER &amp; DEFROST SYSTEM (2881316)</small>	



POLARIS ENGINEERED  
ADVANTAGES

**MOUNTS PERFECTLY**  
Designed for your Polaris Engineered  
bumper, roof or other mounting point

**ADVANCED  
TECH**

RIGID lights are driven by Aluminum PCB Smart Boards, 6063-T5 aircraft aluminum extruded housings and Tiger Drylac UV protection polyester powdercoating.

**EXCLUSIVE  
OPTICS**

RIGID invests heavily in optical science and has patented multiple optics and optics systems, maximizing light output and efficiency.

LIGHT BAR TYPES



**SR-SERIES PRO**

Sleek, powerful, low-profile (under 5 cm tall). Lights extreme distances with low energy usage.  
**Available in 25.4 cm & 81.3 cm**



**D-SERIES PRO**

Compact to fit almost anywhere with high output and low energy usage.  
**Available in Driving, Flood & Spot**

LIGHT BAR OPTIONS

**OPTICS DRIVING FLOOD**

**SPOT**

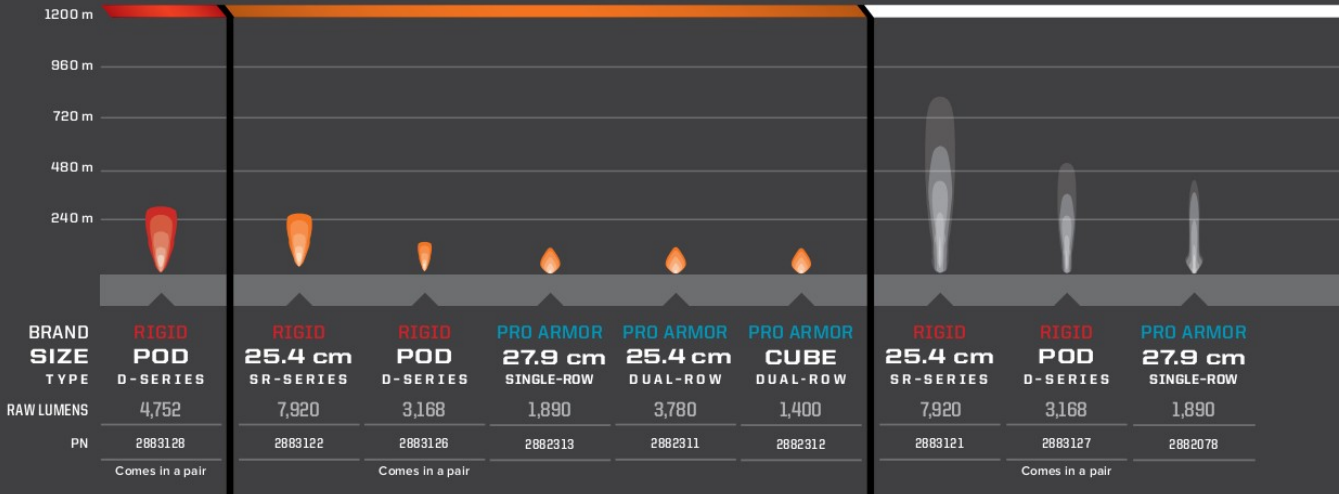

**BUILD YOUR  
VISION**

Consider the optics, angle & how you will use your vehicle to choose the right light or set of lights.

OPTICS LIGHT ANGLE	ACCENT	DRIVING (45°)	FLOOD (25°)	SPOT (10°)	COMBO (25°/10°)
DRIVING SPEED	All	Slow	Medium	Fast	Medium to fast
BEAM	Diffused glow	Extra-wide	Wide/shorter	Concentrated/long	Inner spot & outer flood
RECOMMENDED MOUNTING	Low/wheel well	All points	Low &/or rear	High points	All points
TERRAIN & RIDING STYLE	Added style & personalization in any terrain	All riding & utility	Wide-open terrain or trails & utility	Trail & tight conditions	All riding & utility

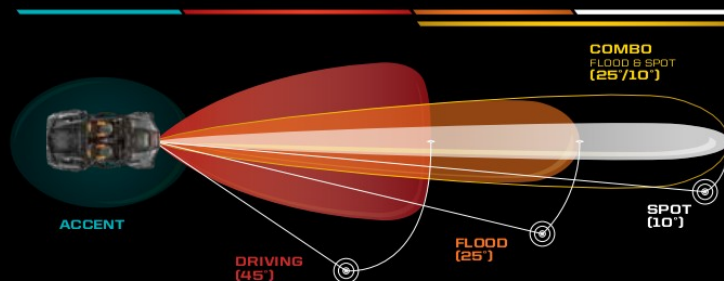

**MAX PERFORMANCE**  
Validated to work as hard as your machine does

**DOESN'T OVERTAX**  
Trust it to work when you need it to



### RUGGED CONSTRUCTION

Pro Armor lights are designed to be big and beefy with an aggressive style all their own, and housed in IP67 marine-grade rated UV polyester powdercoating.

### MASSIVELY BRIGHT

Pro Armor builds bright lights designed for any riding experience. All that power is directed through heat dissipating aluminum for streamlined heat management.



#### DUAL-ROW LED LIGHT BARS

The most spread and farthest illumination downrange. Easy to mount.  
Available in Cube, 25.4 cm, 50.8 cm & 76.2 cm



#### SINGLE-ROW LED LIGHT BARS

Powerful, compact, low-profile light bars with sleek look.  
Available in 27.9 cm, 83.8 cm & 101.6 cm



#### CUBE LED LIGHTS

Small size allows mounting in strategic locations for added lighting.  
Available in Flood & Spot

## COMBO

## OPTICS



### ADD A HARNESS TO MOUNT YOUR LIGHTS

MODEL	LIGHT BAR SET-UPS		
	1 LIGHT IN 1 LOCATION ON 1 SWITCH	2 LIGHTS IN 2 LOCATIONS ON 1 SWITCH	2 LIGHTS IN 2 LOCATIONS ON 2 SWITCHES
2019-2022 ALL MODELS	<p><b>TOP SELLER</b></p> <p>POLARIS PULSE LED LIGHT BAR HARNESS 2883785</p>	<p><b>TOP SELLER</b></p> <p>POLARIS PULSE LED LIGHT BAR HARNESS 2883785</p> <p>Y-HARNESS 2879860</p>	<p><b>TOP SELLER</b></p> <p>POLARIS PULSE LED LIGHT BAR HARNESS (x2) 2883785</p>

⚠ No battery connection cables required on any model/model year POLARIS GENERAL 1000.

All RIGID and Pro Armor lights are Polaris PULSE ready.

## ACCENT LIGHTING

### ACCENT LIGHTS

POLARIS GENERAL XP 1000/4 '20-22  
POLARIS GENERAL 1000/4 '16-22

COLOR	PN
RED (SET OF 4)	2880500
BLUE (SET OF 4)	2880506

ACCESSORIES

WINDSHIELDS & REAR PANELS

DOORS

ROOFS & PROTECTION

STORAGE, CAB COMFORT & HUNT

COOLERS

CONNECTED TECHNOLOGY & AUDIO

LIGHTING

WHEELS & TIRES

WINCHES, PLOWS & TRUCKS

## KNOW YOUR TERRAIN



- Tread patterns optimized for extreme traction
- Ideal for both hard pack and loose trail



- Flexible "grippy" tread
- Aggressive side bite



- Provides traction and durability
- Built to perform in hard sand, jagged rocks or any other extreme terrain

# SUPERIOR PERFORMANCE & DURABILITY



**PRO ARMOR**

## LIFELONG PERFORMANCE

- Every tire is designed and constructed with longevity in mind
- 3,000+ mile rated (4,828 kilometers)

## PREMIUM PROTECTION

- Pro Armor makes tires with extra protection exactly where it's needed most – the sidewall
- Triple-belted sidewalls keep your tires more resistant so you can keep going

## TOUGH TIRES

- Higher ply ratings mean added protection
- Pro Armor builds 8 or 10-ply rated tires for higher puncture-resistance



## KNOW YOUR TIRES

DIMENSIONS			TREAD DEPTH	TIRE WEIGHT	PLY RATING	SIDEWALL BELTS	LOAD RATING
TIRE HEIGHT	TIRE WIDTH	WHEEL DIAMETER					
<b>32" x 9"</b>	<b>R15</b>	<b>FRONT/REAR</b>	<b>30 mm</b>	<b>18 kg</b>	<b>10</b>	<b>3</b>	<b>499 kg</b>
Part Number							
<b>USAGE</b> Where can you use the tire			<b>TREAD DEPTH</b> Deeper treads have more grip in all conditions	<b>TIRE WEIGHT</b> A lighter tire makes for improved vehicle performance	<b>PLY RATING</b> Indicates tire puncture-resistance	<b>SIDEWALL BELTS</b> Increase your resistance to sidewall punctures	<b>LOAD RATING</b> How much weight can the tire handle



- Extra deep treads
- Self-cleaning lugs



- Paddles provide traction and durability in soft sand
- Built to float on top of sand



- Triple-belted sidewalls to resist puncture
- Purpose-built, long lasting tread patterns



- Handles extreme cold
- Holds shape and provides traction

# WAYS TO SHOP

## WHEELS & TIRES

### TIRES BY SIZE

26"	27"	28"	29"	30"
ATTACK	MUD XC	HARVESTER	DUAL-THREAT	CRAWLER XG
DUAL-THREAT	HARVESTER	CRAWLER XR	MUD XC	ATTACK 2.0
HARVESTER		ATTACK 2.0	HD-K	HARVESTER
XD-K		CRAWLER XG		CRAWLER XR
				CRAWLER AT

### TIRES BY TERRAIN

TRAIL	ROCK	DESERT	MUD	UTILITY	SNOW
CRAWLER XR	CRAWLER XR	CRAWLER XR	MUD XC	HARVESTER	ATTACK 2.0
CRAWLER XG	CRAWLER XG	CRAWLER XG		HD-K	ATTACK
MUD XC	DUAL-THREAT	ATTACK 2.0		XD-K	HARVESTER
ATTACK 2.0	ATTACK 2.0	ATTACK			XD-K
ATTACK	CRAWLER AT	DUAL-THREAT			HD-K
DUAL-THREAT		CRAWLER AT			
HARVESTER					
XD-K					
HD-K					
CRAWLER AT					

### WHEELS BY SIZE

14"	15"
40-SERIES (14 TIRE OPTIONS)	50-SERIES (6 TIRE OPTIONS)
4201	5201
4202	5202
4203 BEADLOCK	5203 BEADLOCK
4204	5301 BEADLOCK
4205	
4301 BEADLOCK	
HD DUAL BEADLOCK	

### KNOW YOUR WHEELS

#### STEP 1: SELECT YOUR SERIES

4 = 40-SERIES 5 = 50-SERIES

#### STEP 2: CHOOSE YOUR LOAD RATING

1 = <362.9 KG 2 = 363 - 589.7 KG 3 = 590 - 726+ KG

#### STEP 3: PICK YOUR STYLE

OFFSET / BEADLOCK / COLOR

**INCREASE OFFSET FROM STOCK = NARROWER STANCE**  
**DECREASE OFFSET FROM STOCK = WIDER STANCE**

For off-road use only. Please check fitment with your dealer.

ACCESSORIES

WINDSHIELDS & REAR PANELS

DOORS

ROOF & PROTECTION

STORAGE, CAB COMFORT & HUNT

COOLERS

CONNECTED TECHNOLOGY & AUDIO

LIGHTING

WHEELS & TIRES

WINCHES, PLOWS & TRACKS

# TIRES



FRONT/REAR

## PRO ARMOR CRAWLER XR

- Premium grip for all terrains, from the trail to the rocks
- Square block profile for even surface contact
- A tougher durometer than the XG to take on the toughest the trail has to offer

		TREAD DEPTH	TIRE WEIGHT	PLY RATING	SIDEWALL BELTS	LOAD RATING	
14"	<b>28" x 10" R14</b> 5415536	FRONT/ REAR	16 mm	15 kg	8	3	517 kg



WHEEL SIZE

14"

## WHAT CRAWLER ARE YOU?

### XR

#### SINGLE DUROMETER

- Smaller lug height, added rigidity and lateral stability when cornering
- Unique lug design excels in hard pack, fast terrain



FRONT/REAR

## PRO ARMOR CRAWLER XG

- Built to crawl over all obstacles, both large and small
- A soft, sticky compound makes this tire ideal for both rock crawling and desert running
- 8-ply, triple-belted ballistic sidewalls resist punctures

		TREAD DEPTH	TIRE WEIGHT	PLY RATING	SIDEWALL BELTS	LOAD RATING
14"	<b>30" x 10" R14</b> 5415616	FRONT/ REAR	17 kg	8	3	581 kg
15"	<b>28" x 10" R15</b> 5416346		15 kg			498 kg
16"	<b>30" x 10" R15</b> 5416397		18 kg			581 kg



WHEEL SIZE

14" 15"

### XG

#### DUAL-DUROMETER

- Taller lug height and dual-durometer construction
- Perfect balance between high-speed performance, durability and flex in order to grip slick rock



FRONT/REAR

## PRO ARMOR CRAWLER AT

- Directional tread for optimum performance
- Greater lug separation for easy mud clean out
- 8-ply, triple-belted ballistic sidewalls resist punctures

		TREAD DEPTH	TIRE WEIGHT	PLY RATING	SIDEWALL BELTS	LOAD RATING	
15"	<b>30" x 10" R15</b> 5417534	FRONT/ REAR	18 mm	16 kg	8	3	581 kg



WHEEL SIZE

15"

### AT

#### DIRECTIONAL LUG PATTERN

- The same taller lug height as Crawler XG, providing more grip and better traction
- Wider lug spacing for excellent mud clean-out







FRONT/REAR

## PRO ARMOR ATTACK 2.0

- Engineered for excellent hard pack performance
- Dual-compound technology and radial construction offer performance in all terrains
- Tight thread pattern for a quieter ride

		TREAD DEPTH	TIRE WEIGHT	PLY RATING	SIDEWALL BELTS	LOAD RATING
15"	<b>28" x 10" R15</b> 5416344	FRONT/ REAR	25 mm	10	3	503 kg
15"	<b>30" x 10" R15</b> 5416345					560 kg



WHEEL SIZE

15"

**TIGHTER TREAD PATTERN =**  
Better traction in hard pack

**DUAL-DUROMETER LUG =**  
Increased grip & traction in rough terrain, smoother ride in all terrain

**10-PLY RATED =**  
Increased durability

**LARGER 28" & 30" SIZE OFFERING =**  
More ground clearance & trail traction



FRONT/REAR

## PRO ARMOR ATTACK

- The best all-purpose tire for all-season traction in any terrain
- Unique, full-face tread design
- Harder durometer lugs promote extended wear, increasing tire life
- Wider spaced lugs provide more grip in softer terrain

		TREAD DEPTH	TIRE WEIGHT	PLY RATING	SIDEWALL BELTS	LOAD RATING
14"	<b>26" x 9" R14</b> 5415613	FRONT/ REAR	23 mm	8	3	413 kg
14"	<b>26" x 11" R14</b> 5415614					599 kg



WHEEL SIZE

14"



FRONT/REAR

## PRO ARMOR DUAL-THREAT

- Dual-compound technology and radial construction offer performance in all terrains
- Softer durometer rubber on outer edge for overall superior grip and feel
- Harder durometer rubber in the middle for increased traction during acceleration and longer tread life

		TREAD DEPTH	TIRE WEIGHT	PLY RATING	SIDEWALL BELTS	LOAD RATING
14"	<b>26" x 9" R14</b> 5416340	FRONT/ REAR	16 mm	10	3	413 kg
14"	<b>26" x 11" R14</b> 5416341					499 kg
14"	<b>29" x 9" R14</b> 5416342					499 kg
14"	<b>29" x 11" R14</b> 5416343					599 kg



WHEEL SIZE

14"

**DUAL-COMPOUND = MORE GRIP + LONGER LIFE**



**1** Firmer Durometer Rubber = Longer Life

**2** Softer Durometer Rubber = More Grip

For off-road use only. Please check fitment with your dealer.

# TIRES



FRONT/REAR

## PRO ARMOR MUD XC

- Designed as the perfect mud-trail crossover for a smooth ride on the trail and aggressive traction in the mud
- Dual-compound technology with harder durometer lugs promote extended wear, increasing tire life
- 10-ply construction means added protection in the toughest terrain

		TREAD DEPTH	TIRE WEIGHT	PLY RATING	SEWALL BELTS	LOAD RATING
34"	<b>27" x 9" R14</b> 5416947	FRONT	<b>14 kg</b>			<b>531 kg</b>
34"	<b>27" x 11" R14</b> 5416948	REAR	<b>30 mm</b> <b>15 kg</b>	<b>10</b>	<b>3</b>	<b>599 kg</b>
34"	<b>29" x 10" R14</b> 5416946	FRONT/ REAR	<b>18 kg</b>			<b>630 kg</b>



WHEEL SIZE

14"



## PICKING THE RIGHT UTILITY TIRE

UTILITY FEATURE	HARVESTER	XD-K	HD-K
<b>8,047 Kilometer Rated</b> Long life and performance	X		
<b>10-Ply Rated</b> Higher ply ratings means added protection	X	X	X
<b>Heavy Duty Tread</b> Aggressive tread pattern for all day work on farms or ranches	X	X	X
<b>Turf-Friendly</b> Easy on grass and farm yard	X		
<b>Aramid Fiber Belt</b> 5x times stronger than steel and lighter		X	X
<b>Size Options</b> For exactly how you want to use your machine	26", 27", 28", 30"	26"	29"



FRONT/REAR

### PRO ARMOR HARVESTER

- All-around work horse with tread life of 8047 km
- Tread pattern designed to withstand anything from the farmyard to the pastures and the trail
- With 10-ply, it can carry the load day in and day out

		TREAD DEPTH	TIRE WEIGHT	PLY RATING	SIDEWALL BELTS	LOAD RATING
12"	<b>26" x 8" R12</b> 5416396	FRONT	11 kg			388 kg
12"	<b>26" x 10" R12</b> 5415966	REAR	15 kg			615 kg
14"	<b>27" x 10" R14</b> 5415965	FRONT/REAR	15 kg	10	3	599 kg
14"	<b>28" x 10" R14</b> 5416347	FRONT/REAR	15 kg			630 kg
15"	<b>30" x 10" R15</b> 5417529	FRONT/REAR	17 kg			599 kg



FRONT/REAR

### PRO ARMOR XD-K

- 26" Aramid fiber-belted tire to tackle any terrain
- Unique full-face tread design
- Harder durometer lugs promotes extended wear, increasing tire life

		TREAD DEPTH	TIRE WEIGHT	PLY RATING	SIDEWALL BELTS	LOAD RATING
12"	<b>26" x 9" R12</b> 5415756	FRONT	13 kg	10	3/1 Aramid	388 kg
12"	<b>26" x 11" R12</b> 5415757	REAR	15 kg			499 kg



FRONT/REAR

### PRO ARMOR HD-K

- Designed to provide a smooth ride and aggressive traction in all riding terrains
- Triple-belted sidewall provides extreme protection and extends the tire life
- Quad belt tread core offers superior protection and longer tread life

		TREAD DEPTH	TIRE WEIGHT	PLY RATING	SIDEWALL BELTS	LOAD RATING
14"	<b>29" x 10" R14</b> 5417507	FRONT/REAR	18 kg	10	3/1 Aramid	598 kg



For off-road use only. Please check fitment with your dealer.

# WHEELS



14"

15"

## 40-SERIES

### A 4201 O

FRONT WEIGHT: 5.9 kg | LOAD RATING: 408 kg | OFFSET: +4  
REAR WEIGHT: 6.4 kg | LOAD RATING: 590 kg | OFFSET: -9

ACCENT: FRONT 14" x 7" 1522956-266  
REAR 14" x 8" 1522957-266  
MATTE BLACK: FRONT 14" x 7" 1522956-458  
REAR 14" x 8" 1522957-458

### B 4202 O

FRONT WEIGHT: 5.8 kg | LOAD RATING: 408 kg | OFFSET: +4  
REAR WEIGHT: 6.1 kg | LOAD RATING: 590 kg | OFFSET: -9

ACCENT: FRONT 14" x 7" 1522544-266  
REAR 14" x 8" 1522545-266  
MATTE BLACK: FRONT 14" x 7" 1522544-458  
REAR 14" x 8" 1522545-458

### D 4203 BEADLOCK O O

FRONT WEIGHT: 5.9 kg | LOAD RATING: 408 kg | OFFSET: +4  
REAR WEIGHT: 6.6 kg | LOAD RATING: 590 kg | OFFSET: -9

MATTE BLACK: FRONT 14" x 7" 1522238-458  
REAR 14" x 8" 1522239-458

### E 4204 O

FRONT WEIGHT: 5.9 kg | LOAD RATING: 408 kg | OFFSET: +4  
REAR WEIGHT: 6.4 kg | LOAD RATING: 590 kg | OFFSET: -9

ACCENT: FRONT 14" x 7" 1522546-266  
REAR 14" x 8" 1522547-266  
MATTE BLACK: FRONT 14" x 7" 1522546-458  
REAR 14" x 8" 1522547-458

### F 4205 O

FRONT WEIGHT: 4.8 kg | LOAD RATING: 408 kg | OFFSET: +4  
REAR WEIGHT: 5.7 kg | LOAD RATING: 590 kg | OFFSET: -9

MATTE BLACK: FRONT 14" x 7" 1521507-521  
REAR 14" x 8" 1521508-521  
LUSTER: FRONT 14" x 7" 1521507-410  
REAR 14" x 8" 1521508-410

### G 4301 BEADLOCK

FRONT/REAR WEIGHT: 7.3 kg | LOAD RATING: 729 kg | OFFSET: +38

ACCENT: FRONT/REAR 14" x 7" 1523284  
MATTE BLACK: FRONT/REAR 14" x 7" 1523283

### H HD DUAL BEADLOCK

FRONT/REAR WEIGHT: 18.1 kg | LOAD RATING: 725.7 kg | OFFSET: +38  
MATTE BLACK: FRONT/REAR 14" x 7" 1524022-458

### I 5201

FRONT/REAR WEIGHT: 7.8 kg | LOAD RATING: 590 kg | OFFSET: +4

ACCENT: FRONT/REAR 15" x 7" 1523184-266  
MATTE BLACK: FRONT/REAR 15" x 7" 1523184-458

### J 5202

FRONT/REAR WEIGHT: 8.1 kg | LOAD RATING: 590 kg | OFFSET: +4

ACCENT: FRONT/REAR 15" x 7" 1523102-266  
MATTE BLACK: FRONT/REAR 15" x 7" 1523102-458

### K 5203 BEADLOCK O O

FRONT/REAR WEIGHT: 7.3 kg | LOAD RATING: 590 kg | OFFSET: +38

MATTE BLACK: FRONT/REAR 15" x 7" 1522435-458

### L 5301 BEADLOCK

FRONT/REAR WEIGHT: 7.7 kg | LOAD RATING: 726 kg | OFFSET: +38

ACCENT: FRONT/REAR 15" x 7" 1523282  
MATTE BLACK: FRONT/REAR 15" x 7" 1523266

O LUG NUTS REQUIRED  
O BEADLOCK SOLD SEPARATELY

## BEADLOCK RINGS

14" FORGED BEADLOCK RINGS	PART #
A Machined Fits 4203 Beadlock & HD Dual Beadlock	1522244-266
B Matte Black - Replacement Fits 5301 Beadlock & HD Dual Beadlock	1523146-458
15" FORGED BEADLOCK RINGS	PART #
C Matte Black - Replacement Fits 5203 Beadlock	1523147-458



## KNOW YOUR WHEELS

### STEP 1: SELECT YOUR SERIES

4 = 40-SERIES 5 = 50-SERIES

### STEP 2: CHOOSE YOUR LOAD RATING

1 = <362.9 KG 2 = 363 - 589.7 KG 3 = 590 - 726+ KG

### STEP 3: PICK YOUR STYLE

OFFSET / BEADLOCK / COLOR

INCREASE OFFSET FROM STOCK = NARROWER STANCE  
DECREASE OFFSET FROM STOCK = WIDER STANCE

# KNOW YOUR TERRAIN



- Tread patterns optimized for extreme traction
- Ideal for both hard pack and loose trail



- Extra deep treads
- Self-cleaning lugs



- Triple-belted sidewalls to resist puncture
- Purpose-built, long lasting tread patterns



- Flexible "grippy" tread
- Aggressive side bite

# WHEEL & TIRE SETS

14"

## 40-SERIES

	TRAIL	MUD	MUD	UTILITY	UTILITY	ROCK	ROCK
	DUAL-THREAT 29" 4,828 km	MUD XC 27" 4,828 km	MUD XC 29" 4,828 km	HARVESTER 27" 8,047 km	HARVESTER 28" 8,047 km	CRAWLER XR 28" 4,828 km	CRAWLER XG 30" 4,828 km
4201 Accent	2883146	2884272	2884265	2882388	2883225	2882394	2882396
4201 Matte Black	2883147	2884273	2884266	2882389	2883226	2882395	2882397
4202 Accent	2883148	2884267	2884260	2882383	2883220	2881343	2881560
4202 Matte Black	2883149	2884268	2884261	2882384	2883221	2881344	2881561
4203 BEADLOCK Matte Black BEADLOCKS SOLD SEPARATELY						2881386	
4204 Accent	2883150	2884270	2884263	2882385	2883222	2881355	2881558
4204 Matte Black	2883151	2884271	2884264	2882386	2883223	2881356	2881559
4205 Luster						2881371	2881564
4205 Matte Black	2883152	2884269	2884262	2882387	2883224	2881372	2881563
4301 BEADLOCK Accent BEADLOCKS PRE-MOUNTED	2883219					2883213	2883211
4301 BEADLOCK Matte Black BEADLOCKS PRE-MOUNTED	2883218					2883212	2883210

15"

## 50-SERIES

	TRAIL	TRAIL	UTILITY	UTILITY	ROCK	ROCK
	ATTACK 2.0 28" 4,828 km	ATTACK 2.0 30" 4,828 km	CRAWLER AT 30" 4,828 km	HARVESTER 30" 8,047 km	CRAWLER XG 28" 4,828 km	CRAWLER XG 30" 4,828 km
5201 Accent	2883160	2883169	2889510		2883188	2883179
5201 Matte Black	2883159	2883168	2889511		2883187	2883178
5202 Accent	2883158	2883167	2889512	2885045	2883186	2883177
5202 Matte Black	2883157	2883166	2889513	2885046	2883185	2883176
5203 BEADLOCK Matte Black BEADLOCKS SOLD SEPARATELY	2883154	2883163	2889516	2885048	2883182	2883173
5301 BEADLOCK Accent BEADLOCKS PRE-MOUNTED	2883162	2883171	2889514	2885047	2883190	2883181
5301 BEADLOCK Matte Black BEADLOCKS PRE-MOUNTED	2883161	2883170	2889515	2885048	2883189	2883180

○ LUG NUTS REQUIRED



COLBY SHORT ULTIMATE VALVE (2 PACK)

» 2883292



COLBY VALVE SHORT ULTIMATE VALVE (2 PACK)

» 2883293



COLBY COMBO VALVE KIT (16 PACK)

- Includes eight ultimate valves and eight emergency valves

» 2883294

## REPLACEMENT CAPS

### POLARIS

LUSTER	ALL WHEELS EXCEPT 5203 BEADLOCK & 5204	1521509-410
MATTE BLACK		1521509-521
LUSTER	5203 BEADLOCK	1522243-410
MATTE BLACK		1522243-458
HD MATTE BLACK	ALL WHEELS	9457498-498

### PRO ARMOR

LUSTER	ALL WHEELS EXCEPT 5203 BEADLOCK & 5204	9453209-410
MATTE BLACK		9453209-498
MATTE BLACK	5204	1523063-458
LUSTER	5203 BEADLOCK	1523015-410
MATTE BLACK		1523015-458

## 12mm x 1.5 SPLINED LUG NUTS

○ LUG NUTS REQUIRED

16 SPLINED LUG NUTS WITH WRENCH ADAPTER	2879332
4 SPLINED LUG NUTS WITHOUT WRENCH	2879331
12mm x 1.5 SPLINED LUG WRENCH	2204966

# 2 WAYS TO PURCHASE

INDIVIDUAL WHEELS & TIRES  
- OR -  
COMPLETE SETS AS LISTED

Exclusively at Polaris Authorized Dealers

ACCESSORIES

WINDSHIELDS & REAR PANELS

DOORS

ROOF-SIDE PROTECTION

STORAGE, CAB COMFORT & HUNT

COOLERS

CONNECTED TECHNOLOGY & AUDIO

LIGHTING

WHEELS & TIRES

WINCHES, PLOWS & RACKS

For off-road use only. Please check fitment with your dealer.

# WINCHES

TESTED **1,200+**  
PULLS AT MAX LOAD

**OPERATES FULLY  
SUBMERGED**

BUILT TO WITHSTAND  
**-29° C** TEMPERATURES

**MILITARY  
TESTED & APPROVED**



## FEATURES & BENEFITS

**PRO** PRO HEAVY DUTY SERIES

BEST FOR PLOWING, HEAVY-DUTY OUTDOOR  
CHORES & TRAIL RIDING

**HD** HEAVY DUTY SERIES

BEST FOR THE CASUAL  
OFF-ROAD RIDER

### ALL POLARIS ENGINEERED WINCHES COME WITH:

- ✓ INTEGRATED WIRING, MOUNT, PREASSEMBLED
- ✓ HOOK WITH STRAP
- ✓ CUT STEEL GEARS & SEALED DRIVETRAIN
- ✓ SEALED PERMANENT MAGNET MOTOR

#### RAPID ROPE RECOVERY **5X** FASTER

Retrieve cable 5x as fast as standard mode on other Polaris winches. Get back to riding or complete your task quicker.

1. Set winch dial to N (Neutral) to manually pull the rope out and secure the hook to your anchor point
2. Set winch dial to L (Low) for maximum pulling power while winching your load
3. Set winch dial to H (High) for retrieving the rope 5x faster with Rapid Rope Recovery



NOT AVAILABLE

#### AUTO STOP TECHNOLOGY **AUTO**



Auto Stop technology protects and extends the life of your winch by automatically stopping the winch at the end of pull to prevent over-spooling. While plowing, it prevents the plow frame from bending by stopping the winch once the plow has been lifted.



ADD AUTO STOP UPGRADE

2881288

SYNTHETIC ROPE REQUIRED



#### PREMIUM SYNTHETIC ROPE

With its lightweight, yet extremely strong, design and superior flexibility, this 15 m long synthetic rope is easy to handle and can stand up to any tough job.



ADD SYNTHETIC ROPE

2879187



#### WIRELESS REMOTE

This convenient remote operates your Polaris winch wirelessly from within 15 m of the vehicle. Operate your winch safely outside your vehicle while on the job site or trails.



ADD WIRELESS REMOTE

2881287



MODEL

2,041 kg

2,041 kg

**POLARIS GENERAL XP 1000/4 '20-22**

**2883861**

**POLARIS GENERAL 1000/4 '19-22**

**TOP SELLER**  
**2883860**

# PLOWS & TRACKS

## PLOW SYSTEMS (WINCH REQUIRED, SOLD SEPARATELY)

Choose a Glacier Plow System, designed to help you get the most out of your GENERAL during snowy months. Select a system based on your plowing needs with premium add-ons including a hydraulic lift system or additional plow accessories.

### **NEW** GLACIER PRO HD PLOW SYSTEM WITH HYDRAULICS

System includes:

- Mount (2881763)
- Frame (2880260)
- 183 cm Steel Plow (2880270)
- Hydraulic Angle (2885102)
- Hydraulic Controller (2883391)
- Plow Markers (2872726)
- Plow Deflector (2858541)

» 3880014

POLARIS GENERAL XP 1000/4 '20-22  
POLARIS GENERAL 1000/4 '16-22

Requires lift method:  
see winches below.

### **NEW** GLACIER PRO HD PLOW SYSTEM

System includes:

- Mount (2881763)
- Frame (2880260)
- 168 cm Poly Plow (2880269)

» 3880015

POLARIS GENERAL XP 1000/4 '20-22  
POLARIS GENERAL 1000/4 '16-22

Requires lift method:  
see winches and hydraulic lift options below.

### **NEW** GLACIER HD PLOW SYSTEM

System includes:

- Mount (2883256)
- Frame (2882927)
- 183 cm Steel Plow (2889307)

» 3880016

POLARIS GENERAL XP 1000/4 '20-22  
POLARIS GENERAL 1000/4 '16-22

Requires lift method:  
see winches and hydraulic lift options below.

CHOOSE A PLOW SYSTEM

## GLACIER PRO HD PLOW SYSTEM

## GLACIER PRO HD GIVES YOU

» 183 cm or 168 cm Blades » Choice of poly or steel » Manual angle system standard



168 cm POLY BLADE  
BEST FOR CORROSION RESISTANCE



183 cm STEEL BLADE  
BEST FOR BIG JOBS YEAR AFTER YEAR

CREATE YOUR PLOW SYSTEM	STEP 1 SELECT A MOUNT	STEP 2 SELECT A FRAME	STEP 3 SELECT A LIFT METHOD	STEP 4 SELECT A BLADE	STEP 5 SELECT ACCESSORIES
MODELS	MOUNT	FRAME	WINCH	BLADES	ACCESSORIES
POLARIS GENERAL XP 1000/4 '20-22	2881763	<b>TOP SELLER</b> 2880260	<b>Polaris PRO HD 2,041 kg Winch</b> 2883861 POLARIS GENERAL XP 1000/4 '20-22 POLARIS GENERAL 1000/4 '19-22	<b>TOP SELLER</b> 183 cm Steel 2880270  168 cm Poly 2880269  <b>TOP SELLER</b> 168 cm Steel 2880268	183 cm Blade Snow Deflector 2858541 183 cm HD Wear Bar 2879875 183 cm Wear Bar 2204976 168 cm Blade Snow Deflector 2879866 168 cm HD Wear Bar 2879868 168 cm Wear Bar 2879867 Plow Marker 2872726 168 cm Blade Plow Shoe 2208864 Shear Pin 2205527 Replacement T Shear Pin 2204829 Extension for Tracks 2880267 Heavy Duty Deflector 2884160
POLARIS GENERAL 1000/4 '16-22			<b>Hydraulic Plow Angle</b> 2885102 POLARIS GENERAL 1000/4 '16-18  <b>Hydraulic Plow Controller</b> 2883391 POLARIS GENERAL XP 1000/4 '20-22 POLARIS GENERAL 1000/4 '16-22		

## GLACIER HD PLOW SYSTEM

## GLACIER HD GIVES YOU

» 168 cm Blades » Choice of poly or steel » Manual angle system standard

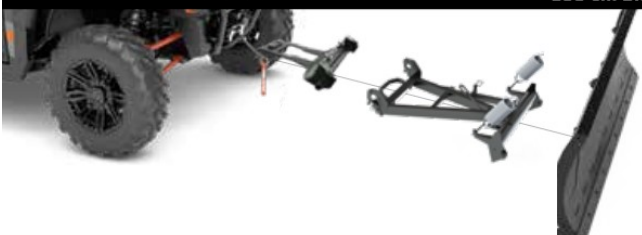

168 cm POLY BLADE  
BEST FOR CORROSION RESISTANCE



168 cm STEEL BLADE  
BEST FOR BIG JOBS YEAR AFTER YEAR

Choose a steel blade for longevity and increased rigidity or a lightweight non-stick, poly blade that's easier on plowing surfaces.

CREATE YOUR PLOW SYSTEM	STEP 1 SELECT A MOUNT	STEP 2 SELECT A FRAME	STEP 3 SELECT A LIFT METHOD	STEP 4 SELECT A BLADE	STEP 5 SELECT ACCESSORIES
MODELS	MOUNT	FRAME	WINCHES	BLADES	ACCESSORIES
POLARIS GENERAL XP 1000/4 '20-22	2883256	2889307	<b>Polaris HD 2,041 kg Winch</b> 2883860 POLARIS GENERAL XP 1000/4 '20-22 POLARIS GENERAL 1000/4 '19-22	168 cm Poly 2880269  168 cm Steel 2880268	168 cm Blade Snow Deflector 2879866 168 cm HD Wear Bar 2879868 168 cm Wear Bar 2879867 Plow Marker 2872726 168 cm Plow Shoe 2208864 Shear Pin 2205527 Replacement T Shear Pin 2204829
POLARIS GENERAL 1000/4 '16-22					



### PROSPECTOR PRO TRACK MOUNTS

• Install in place of tires and wheels. Tracks sold separately.

» 2880649

POLARIS GENERAL 1000/4 '16-22

» 2885117

POLARIS GENERAL XP 1000/4 '20-22

### PROSPECTOR PRO TRACK

» 2880758

POLARIS GENERAL 1000/4 '16-22  
POLARIS GENERAL XP 1000/4 '20-22

If using Glacier Pro Plow System, Track Plow Extension is required (2880267)

ACCESSORIES

WINDSHIELDS & REAR PANELS

DOORS

ROOFS & PROTECTION

STORAGE, CAB COMFORT & HUNT

COOLERS

CONNECTED TECHNOLOGY & AUDIO

LIGHTING

WHEELS & TIRES

WINCHES, PLOWS & TRACKS

# FOR THE LIFE OF YOUR RIDE

## MAINTENANCE TIP

### BREAK-IN PERIOD

The break-in period for your new GENERAL is the first 25 hours of operation, or the time it takes to use the first two tanks of fuel. No single action on your part is as important as a proper break-in period. Careful treatment of a new engine will result in more efficient performance and longer life for the engine.

**NOTICE** Excessive heat build-up during the first three hours of operation will damage close-fitted engine parts. Do not operate at full throttle or high speeds for extended periods during the first three hours of use.

### AIR FILTER

A clogged air filter can restrict air flow to the engine leading to reduced engine performance, engine life or catastrophic failure.

### BRAKE PADS

Maintaining and/or replacing brakes are critical to the safety and functionality of a vehicle. Brake pads should be checked for wear and oil or grease (petroleum products) contamination and brake discs should be checked for cracks, excessive corrosion or warping.

### HALF SHAFT

Check for tears and punctures in the boot, which can lead to CV joint wear that can contribute to axle failure.

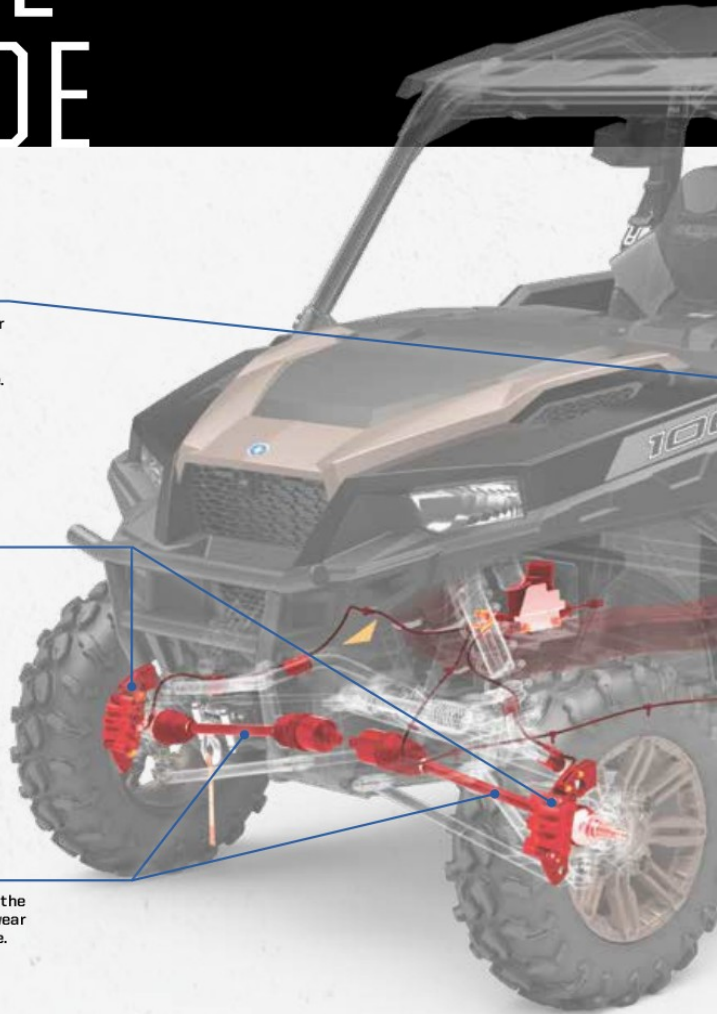

## MAINTENANCE SCHEDULE

25 HRS / 400 km

### BREAK-IN MAINTENANCE

- ENGINE OIL & OIL FILTER:**  
CHANGE
- GENERAL LUBRICATION:**  
ALL FITTINGS, PIVOTS, CABLES, ETC.
- AIR FILTER:**  
INSPECT & REPLACE AS NEEDED
- EXHAUST SYSTEM:**  
INSPECT & CLEAN  
INSPECT FOR LEAKAGE OR CARBON BUILD UP AT JOINTS  
INSPECT & CLEAN SCREEN TYPE SPARK ARRESTOR

50 HRS / 800 km

### 6 MONTHS

- EXHAUST SYSTEM:**  
INSPECT & CLEAN  
INSPECT FOR LEAKAGE OR CARBON BUILD UP AT JOINTS  
INSPECT & CLEAN SCREEN TYPE SPARK ARRESTOR
- GENERAL LUBRICATION:**  
ALL FITTINGS, PIVOTS, CABLES, ETC.
- DRIVE BELT:**  
INSPECT & ADJUST  
REPLACE AS NEEDED

100 HRS / 1,600 km

### 12 MONTHS

- ENGINE OIL & OIL FILTER:**  
CHANGE
- DRIVE BELT:**  
INSPECT & ADJUST  
REPLACE AS NEEDED
- TRANSMISSION FLUID:**  
CHANGE
- AIR FILTER:**  
INSPECT & REPLACE AS NEEDED
- EXHAUST SYSTEM:**  
INSPECT & CLEAN  
INSPECT FOR LEAKAGE OR CARBON BUILD UP AT JOINTS  
INSPECT & CLEAN SCREEN TYPE SPARK ARRESTOR

150 HRS / 2,400 km

### 18 MONTHS

- ENGINE OIL & OIL FILTER:**  
CHANGE
- BATTERY:**  
TEST, CLEAN & CHECK FLUID LEVEL  
REPLACE AS NEEDED
- DRIVE BELT:**  
INSPECT & ADJUST  
REPLACE AS NEEDED
- TIRES:**  
INSPECT CONDITION & PRESSURE
- EXHAUST SYSTEM:**  
INSPECT & CLEAN  
INSPECT FOR LEAKAGE OR CARBON BUILD UP AT JOINTS  
INSPECT & CLEAN SCREEN TYPE SPARK ARRESTOR



**PARTS THAT PUSH THE LIMITS WITHOUT SACRIFICING STRENGTH AND DURABILITY.**

We build our products so anyone with the right tools can maintain their vehicle.

**POLARIS**  
ENGINEERED PARTS & LUBRICANTS

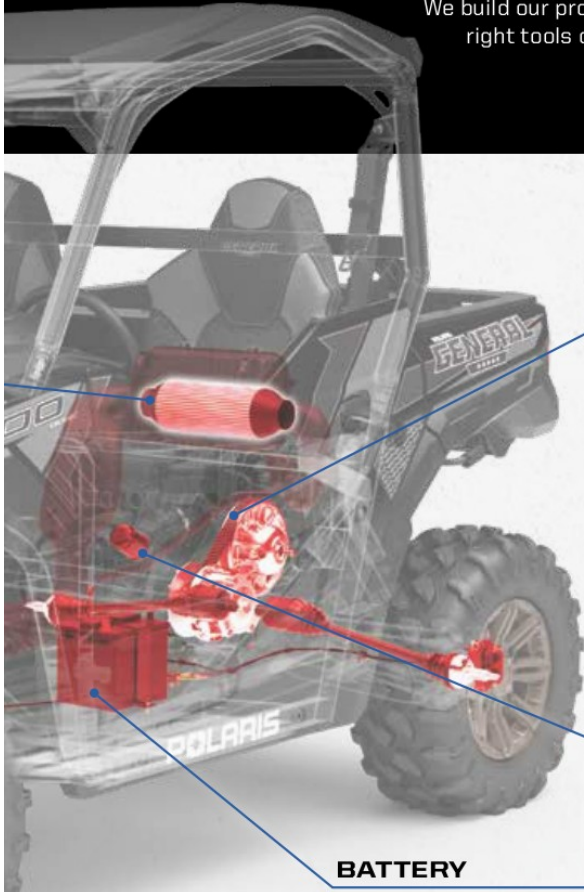

**BATTERY**

To ensure a battery maintains its level of charge when unused for extended periods of time or during freezing weather, the battery should be connected to a suitable battery charger. Be sure to check for corrosion from the terminals to the ends of the cables.

**DRIVE BELT**

Polaris Engineered belts deliver unmatched performance for your off-road vehicle. Developed and tested on all our engines for all environments and conditions. Check your belt for delamination, hour glassing and glazing.

**BREAK-IN PERIOD**

- Use lower gear (if available) while varying speeds and avoid wide open throttle for 8-16 km
- If no low gear is available, vary at moderate speeds while avoiding wide open throttle for 80 km

**OUR INVESTMENT**

- 32,187 km of field testing
- Thousands of dyno hours
- 18+ months of development (13,000+ design hours) per belt
- 1,500+ vehicle validation hours
- Collaboration with powertrain and clutch engineers

**YOUR ADVANTAGE**

- No clutch recalibration
- Less wear and tear due to heat
- Ensure maximum vehicle performance
- More time riding, less time wrenching
- Produced in collaboration with powertrain and clutch engineers to ensure a perfect fit, maximum performance and ultimate durability

**OIL FILTER**

Change oil filters with every oil change to provide the best engine protection and keep the engine operating at peak performance.

**FOLLOW RECOMMENDED SERVICE INTERVALS IN THE OWNER'S MANUAL**

200 HRS / 3,200 km

**24 MONTHS**

- ENGINE OIL & OIL FILTER:** CHANGE
- BRAKE PADS & FLUID:** INSPECT & CLEAN  
REPLACE BRAKE FLUID  
REPLACE AS NEEDED
- SPARK PLUGS:** INSPECT  
REPLACE AS NEEDED
- AIR FILTER:** INSPECT & REPLACE AS NEEDED
- EXHAUST SYSTEM:** INSPECT & CLEAN  
INSPECT FOR LEAKAGE OR CARBON BUILD UP AT JOINTS  
INSPECT & CLEAN SCREEN TYPE SPARK ARRESTOR

250 HRS / 4,023 km

**30 MONTHS**

- ENGINE OIL & OIL FILTER:** CHANGE
- BATTERY:** TEST, CLEAN & CHECK FLUID LEVEL  
REPLACE AS NEEDED
- DRIVE BELT:** INSPECT & ADJUST  
REPLACE AS NEEDED
- GENERAL LUBRICATION:** ALL FITTINGS, PIVOTS, CABLES, ETC.
- EXHAUST SYSTEM:** INSPECT & CLEAN  
INSPECT FOR LEAKAGE OR CARBON BUILD UP AT JOINTS  
INSPECT & CLEAN SCREEN TYPE SPARK ARRESTOR

300 HRS / 4,828 km

**36 MONTHS**

- ENGINE OIL & OIL FILTER:** CHANGE
- AIR FILTER:** INSPECT & REPLACE AS NEEDED
- GEARCASE & TRANSMISSION:** REPLACE FLUIDS
- EXHAUST SYSTEM:** INSPECT & CLEAN  
INSPECT FOR LEAKAGE OR CARBON BUILD UP AT JOINTS  
INSPECT & CLEAN SCREEN TYPE SPARK ARRESTOR

**CHECK YOUR OWNER'S MANUAL FOR ADDITIONAL RECOMMENDED SERVICE ITEMS AND VEHICLE-SPECIFIC TIMING**

# POLARIS

## ENGINEERED PARTS & LUBRICANTS

### FOR THE LIFE OF YOUR RIDE ONLY THE BEST WILL DO

To create the best oil for any terrain, we invest in rigorous testing to ensure our oil delivers the consistency and performance you demand. The results are Polaris Engineered Lubricants that are tested and perfected to deliver excellent total engine protection for the life of your ride.

#### WHAT COUNTS IN OIL TESTING:

1. Does it protect the engine at high temperatures?
2. Does it keep the engine free from carbon and buildup?
3. Does the oil hold its viscosity over time?

#### ENGINE CHECKPOINTS

When evaluating an engine oil and its ability to protect and preserve the engine's power output and lifespan, Polaris engineers focus on key areas within the engine, some of the most critical ones include:

**RING LANDS:** Poor oxidative performance can lead to carbon and varnish buildup, which results in poor ring seal and loss of power, combustion blow by and fuel dilution of the oil.

**PISTON RINGS:** During the combustion process, extreme pressures are placed on the top ring, forcing it outward toward the cylinder wall, sealing the combustion chamber. With so much force applied, poor oil film strength between the top ring and the cylinder wall can lead to cylinder wear and loss of power.

**ROD BEARINGS:** Engine bearings ride on an extremely thin hydrodynamic film of oil. Poor oil film strength or using an oil with a thinner viscosity, can lead to premature bearing wear or even engine failure. Using an oil with high film strength and a strong viscosity, like PS-4 full synthetic, will extend the service life of your engine.

**CAMSHAFT:** Direct Acting Overhead Camshafts are used on many Polaris Prostar Engines. In this application the camshaft pushes directly on the valve, creating very high contact pressures compared to other camshaft configurations. These forces are so great that inferior oil can break down and be forced out of the contact area leading to increased wear. PS-4 full synthetic additives are specifically designed to provide wear protection against this.

#### OIL DEVELOPMENT

**12 DEDICATED  
TEAM MEMBERS**

**FOCUSED ON  
POLARIS OIL**

**64,374  
KILOMETERS**

**FIELD  
TESTING**

**18+  
MONTHS**

**DEVELOPMENT  
& TESTING**

**75,000+  
HOURS**

**DYNO  
TESTING**



# SPECIFIC NEEDS, SPECIFIC OILS

Polaris invests millions in engine development, and part of that investment is making sure its lubricants—critical to engine performance—are the right formula for your specific engine. The amount of testing data and engineering resources used in developing Polaris lubricants would overwhelm an aftermarket company. Therefore, the aftermarket must spec an oil to an industry-wide standard that must account for a variety of operating parameters.

PS-4 is designed specifically for Polaris 4-cycle engines and has high film strength and wear protection under extreme loads and temperatures. Exclusive anti-wear additives protect engine parts with extra rust and corrosion protection.

#### PS-4 SYNTHETIC PERFORMANCE OIL

• PS-4 is optimal for ambient operating temperatures of -40° C to 40° C

- › 1L • 502484
- › 4L • 502485
- › 25 L • 502486
- › 60 L • 502487
- › 200 L • 502488

#### PS-4 OIL CHANGE KIT

• Contains the correct amount of oil for your vehicle and correct oil filter

- › 502541  
SINGLE 570, TWIN 600, TWIN 700, TWIN 800
- › 502543  
RANGER/RZR 900/1000
- › 502542  
330500, SPORTSMAN 550/850/1000

#### PS-4 EXTREME- DUTY SYNTHETIC PERFORMANCE OIL

• PS-4 Extreme Duty is optimal for ambient operating temperatures of -20° C to 55° C

- › 1L • 502491
- › 4L • 502492
- › 25 L • 502494
- › 60 L • 502496
- › 200 L • 502497

# ENGINEERED TO MAXIMIZE THE LIFE OF YOUR RIDE

All Polaris fluids—from anti-freeze to brake fluid—are developed for your vehicle. Trust the only fluids perfectly engineered for your needs.



## DOT 4 BRAKE FLUID

Polaris DOT 4 Brake Fluid is a high-quality brake fluid designed for use in Polaris hydraulic brakes. Superior high-temp characteristics plus anti-corrosive additives extend the life of brake system components and provide consistent, positive braking.

› 250 mL • 502526



## ANTI-FREEZE

Polaris Extended Life Coolant contains organic acid technologies to prevent corrosion on metal components, eliminate scaling, and maximize cooling system performance.

› 1 L • 502566  
› 25 L • 502567  
› 206 L • 502568



## AGL

A proprietary blend of additives designed to optimize Polaris' ORV transmission life. Extreme pressure additives protect gears, drive chain, and bearings from scoring and wear. Unlike typical gear case oils, AGL's unique viscosity range allows instant flow and film protection in extreme cold or high heat environments.

› 1 L • 502505  
› 25 L • 502507  
› 200 L • 502508



## DEMAND DRIVE FLUID

Engineered specifically for Polaris ORV front drive systems. Provides positive 4WD engagement in extreme cold or high heat conditions. Unique friction additives protect internal components under heavy loads and promote positive engagement.

› 1 L • 502563  
› 25 L • 502564  
› 200 L • 502565

Proper lubricant application and timing will ensure optimal vehicle performance. Please refer to your owner's manual for lubricant change interval schedules.



## CARBON CLEAN

Polaris Carbon Clean prevents ethanol corrosion, stabilizes fuel, and cleans fuel injectors, piston ring lands, intake systems, and combustion chambers. Helps maintain peak HP and improves fuel economy.

› 125 mL • 502528



## FUEL STABILIZER

Fuel Stabilizer prevents ethanol corrosion and stabilizes fuel for up to 2 years. Dual-antioxidant formula protects against gum and varnish for easy starting.

› 125 mL • 502519



## ANGLE DRIVE FLUID

› 1 L • 502510  
› 25 L • 502511  
› 202 L • 502512  
SPORTSMAN,  
RANGER, RZR  
ANGLE DRIVE GEAR  
CASE SYSTEMS



## PREMIUM GAS SHOCK OIL

› 1 L • 502518



## ALL-SEASON GREASE TUBE

› 400 g • 502538

# HD HEAVY DUTY PARTS

All Polaris parts are developed and tested to help you get the most out of your ride. We're taking the passion of our riders, workers and outdoor enthusiasts to the next level with HD Parts.

Engineered and designed for:

- Greater durability
- Enhanced performance
- Greater wear and tear capabilities
- All weather conditions



## NEW DRIVE BELTS

The enhanced rubber material compound in these belts keep them cool in extreme heat, while our patented cord treatment process maximizes the transfer of horsepower to the ground for those customers hauling heavy loads.

OE	HD HEAVY DUTY PARTS
3211149	
3211169	3212326
3211196	
3211113	3212328



## NEW OIL FILTERS

The advanced synthetic material built into these filters offers the highest debris holding capacity, maintains oil flow and maximizes performance.

OE	HD HEAVY DUTY PARTS
2540086	2522498



## WHEELS & TIRES

Class leading durability for off-road performance and traction for confident driving in extreme conditions.

- » 1524022-458 • HD WHEEL - 14x7\*
- » 5417507 • PRO ARMOR HD-K - 29x10R14\*
- » 5457498-458 • HD WHEEL CENTER CAP\*
- » 5415756 • PRO ARMOR XD-K FRONT
- » 5415757 • PRO ARMOR XD-K REAR

\* SHOWN

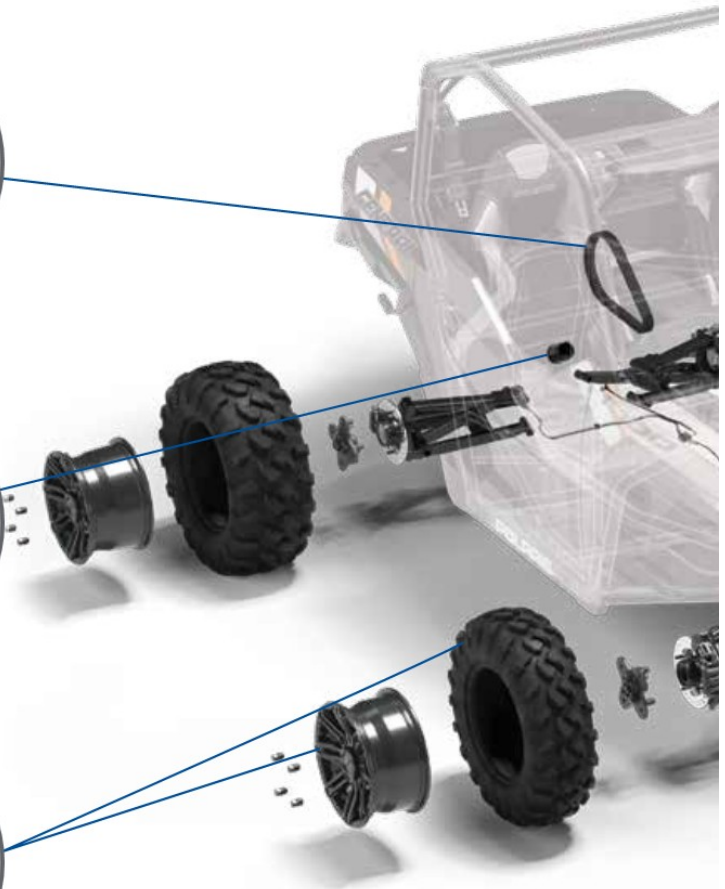

Claims made based off testing and performance of Polaris HD Parts against standard OEM parts made by Polaris and competitor brands under normal use.

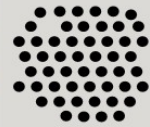

SAND



MUD



WATER



EXTREME COLD



EXTREME HEAT UP TO 54° C



HEAVY PAYLOADS



EXTENDED LIFE

PARTS & GARAGE

MAINTENANCE

OIL & LUBRICANTS

HD PARTS

SERVICE PARTS

CLEANERS & TRAILERING

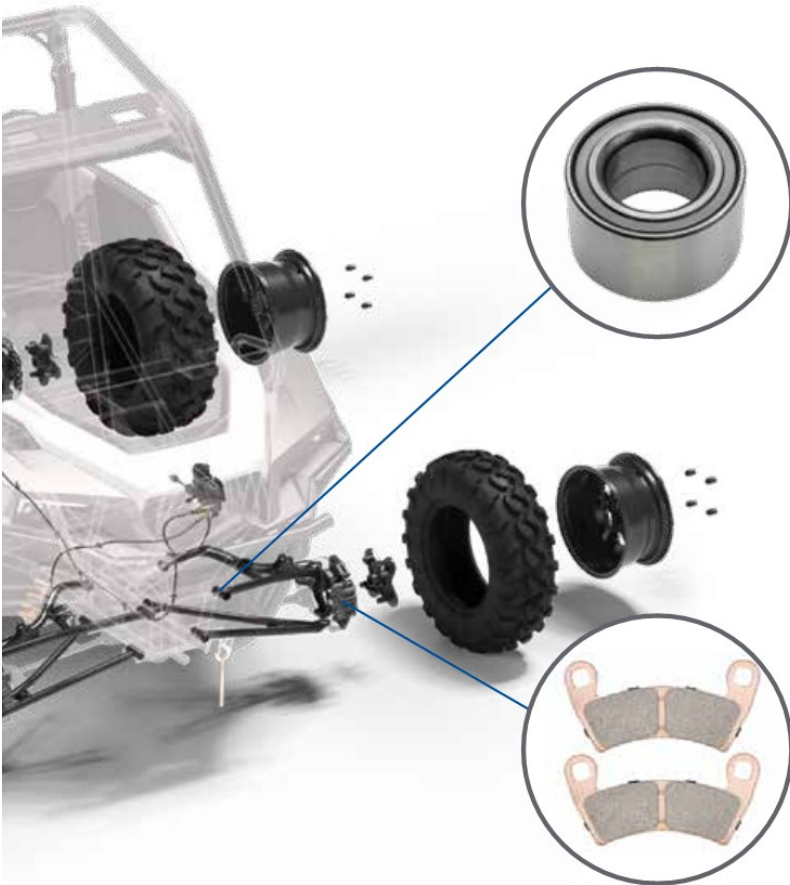

### WHEEL BEARINGS

Fully sealed for added protection against intrusions. Made of a higher grade steel for extended life in extreme conditions.

LOCATION	OE	HD <small>HEAVY DUTY PARTS</small>
FRONT	3514924	3515090
REAR		

### BRAKES

Engineered to provide longer life and better stopping power while riding in extreme conditions.

OE	HD <small>HEAVY DUTY PARTS</small>
2205949	2208933
2202413	2208934
2203318	2208936

For more information regarding Polaris HD parts including vehicle compatibility, installation and maintenance, please contact your authorized Polaris ORV dealer.

# SERVICE PARTS

**Polaris Engineered service parts deliver unmatched performance and fit for your off-road vehicle.**

All service parts are engineered specifically for your machine. Which means everything is designed, tested and perfected to maximize the life of your ride. Getting Polaris Engineered parts is a decision that pays off in the long run, because it ensures there is a long run.



**PARTS  
FINDER**

**VISIT YOUR POLARIS  
DEALER TO SHOP FOR  
SERVICE PARTS.**

**OVER  
100,000  
PARTS  
AVAILABLE!**



# FOR THE LIFE OF YOUR RIDE

Maintenance is the key to keeping your Polaris off-road vehicle performing at its peak. Items like belts, lubricants, and batteries represent only a few of these critical items engineered specifically by Polaris.



## POLARIS ENGINEERED DRIVE BELTS

### TESTED, PERFECTED

We test each belt on the intended vehicle – we don't just try to make an existing belt "just work".

– Amery Kuhl, Polaris CVT System Engineer

#### OUR INVESTMENT

- 32,187 km of field testing
- Thousands of dyno hours
- 18+ months of development (3,000+ design hours) per belt
- 1,200+ vehicle validation hours
- Collaboration with powertrain & clutch engineers

#### YOUR ADVANTAGE

- No clutch recalibration
- Less wear & tear due to heat
- Ensure maximum performance of your vehicle
- More time out riding, less time wrenching

**OUR INVESTMENTS ENSURE POLARIS BELTS  
OUTPERFORM YOUR EXPECTATIONS.**

# CV BOOT REPAIR KIT\*

FIX ON THE GO | TEMPORARY COVERAGE

- A quick trail-side fix to increase trail time
- The flexible and durable boot material expands "over a cone tool for CV boot repairs, without disassembling CV axles
- Universal fit - works as a temporary fix for most powersports axles
- All components fit inside the cone, and a cover is provided for compact durable storage
- Easily fits in a cargo box, attached to the roll cage, in the glovebox or many other storage locations



Items shown are contained inside cone

## UTV CV BOOT REPAIR KIT

Kit includes the following items:

- (1) Expandable XL CV Boot
- (1) Reusable Cone Tool
- (2) CV Boot Clamps
- (1) Tube of Silicone Lube
- (1) Grease Packet
- (1) Cone Cover

› 2830526

## UTV TRAIL BOOT ONLY

› 2830527

## ATV

› CV REPAIR KIT  
2830528

› TRAIL BOOT ONLY  
2830529

### HOW TO INSTALL

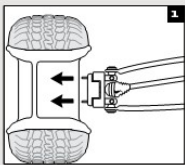

Remove wheel and axle nut.

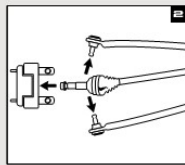

Remove brake caliper, hub, tie rod and upper and lower ball joints.

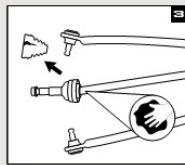

Remove old boot and clean joint.

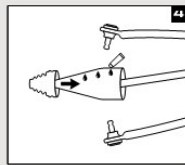

Spread silicone lube on entire cone tool. Slide boot over cone tool, large end first. See package for outer boot instructions.

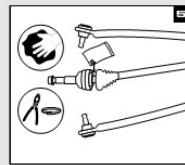

Empty the bag of grease into the CV joint/boot, clean sealing points and install clamps.

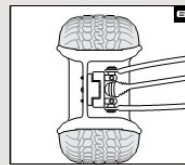

Reassemble tie rod, ball joints, brake caliper, axle nut, tire and wheel.

Refer to your service manual for further instructions and torque specifications.  
\*Designed for temporary CV boot repair. Purchase the OEM CV Boot for a permanent repair.

# KEEP IT CLEAN

## CLEAN

### ALL-PURPOSE CLEANER

- Professional cleaner, which is formulated with a low pH-value. The product spreads well on surfaces and adheres on them for effective cleaning action. Perfectly compatible with rubber, plastic and painted surfaces. The formulation is biodegradable.

› 500 mL • 502309

## SHINE

### INSTANT SHINE & DETAILER

- The INSTANT SHINE AND DETAILER is developed for cleaning action without water. Removes insects, dust and dirt with almost no effort. Applicable for plastics, visors, windscreens, paint and metal. The wipe and shine formulation makes surfaces shine, works water repellent and also has an antistatic effect. Perfect for customers living in urban areas with no access to water, for bike trips or showroom bikes.

› 500 mL • 502303





# BRING IT EVERYWHERE

## TRAILERING



### CALIBER RAMP PRO

- Designed for ATVs and UTVs up to 127 cm wide
  - Integrated grip glides for ultimate traction
  - Folding sides for easy transportation and storing
- » 132 cm x 229 cm • 2884576



### ALUMINUM ARCHED LOADING RAMP

- Capacity for up to 1,361 kg, 680.7 kg per ramp
- » 193 cm x 30.5 cm • 907 kg • 2875384  
» 224 cm x 30.5 cm • 1,361 kg • 2875386



### LIGHTWEIGHT TRI-FOLD RAMP

- Ramp folds up for transport
  - Capacity for up to 680.7 kg
  - Safety straps included
- » 183 cm x 130 cm • 2875385  
» 208 cm x 130 cm • 2875860



### FOLDING ALUMINUM ARCHED RAMP

- Ramp folds up for transport
  - Up to 680 kg total capacity, 340 kg per individual ramp
  - Safety straps included
- » 224 cm x 30.5 cm • 2875387

## HITCHES

### 3:1 HITCHES

VERSATILE 3 IN 1 FUNCTIONALITY

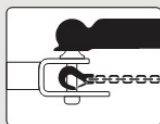

BALL

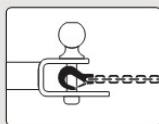

HOOK

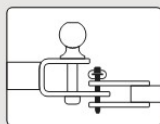

PIN

- Ball, hook and pin design
- Durable, rust resistant steel with black powdercoated finish
- Removable ball
- HD 1.6 cm pin and clip



### HITCH WITH 5 cm BALL

- » 5 cm x 5 cm RECEIVER 2830522
- » 3 cm x 3 cm RECEIVER 2830523



### 4.8 cm BALL

- 4.8 cm replacement ball for hitch
  - Designed to work with 3:1 Hitch
- » 2830524



### RECEIVER HITCH

- » 5 cm RECEIVER TONGUE 2875320



### TRAILER BALL 1.9 cm SHANK

- » 4.8 cm BALL • 2877602
- » 5 cm BALL • 2877603

## STRAPS & ROPES



### RECOVERY STRAP

- 5 cm x 9.1 m
  - 8,165 kg maximum load / 4,082 kg maximum vehicle weight
  - Comes with carry bag
- » 2884033



### RATCHET STRAP

- 3.8 cm x 4.6 m straps, 2 Pack
  - Heavy duty webbing
  - 2,495 kg maximum load, 831 kg working load
- » 2884031



### RATCHET STRAP

- 5 cm x 6.1 m Ratchet Straps
  - Heavy duty webbing, floating D-rings, double J-hooks
  - 4,536 kg maximum load, 1,497 kg working load
- » 2884032



### SHOCK STRAPS

- 3.8 cm 1,361 kg breaking strength
  - Keeps tension on tie-down straps to secure load, 2 Pack
- » 3.8 cm x 4.6 m • 2883296  
» 3.8 cm x 2.1 m • 2883295

## COVERS



### TRAILERABLE COVER BY POLARIS

- » 2-SEAT • 2881841  
POLARIS GENERAL XP 1000 '20-22  
POLARIS GENERAL 1000 '16-22
- » 4-SEAT • 2881787  
POLARIS GENERAL XP 4 1000 '20-22  
POLARIS GENERAL 4 1000 '17-22



### POLARIS SxS CAMO FIELD COVER

- » 2882160  
POLARIS GENERAL XP 1000/4 '20-22  
POLARIS GENERAL 1000/4 '16-21

# RACING COLLECTION



## TECHNICAL JACKET

- Water-resistant jacket
- Ultra-light thanks to polyester ripstop and softshell for optimal comfort
- Ventilated lining
- Hydration hose outlet
- Zip ventilation system on body and back

Black | S-3XL | 2802001



## TECHNICAL PANTS

- Water-resistant pants
- Ultra-light thanks to polyester ripstop, softshell and 1000-D Cordura Stretch fabric on the back for optimal comfort
- 2 cargo type pockets
- Zip ventilation system
- Zip and Velcro adjustment at the bottom of the pants

Black | S-3XL | 2802002



## **NEW** TECHNICAL SHIRT

- 100% polyester
- Indelible sublimated graphics
- Hemmed edging
- Lycra cuffs and collar

Black | S-3XL | 2802104



## **NEW** BODYWARMER

- Upper body and side panels in softshell waterproof and breathable 3000mm/3000g
- Lower body Nylon downproof
- Padding 80 g
- Two external pockets with easy-grab puller

Black | S-3XL | 2802101



## **NEW** SAFETY GLOVES TOUCH CE

- CE-approved motorcycle glove EN 13594:2015
- Touch screen compatible
- Silicon print on fingers to improve grip
- Neoprene cuff with Velcro tightening
- Reinforcement patches for safety and comfort

Black | XS-7,3XL-13 | 2802103



## RACING SOFTSHELL

- Softshell waterproof and breathable 3000mm/3000g
- Removable hood
- Four external pockets with easy-grab puller

Black | S-3XL | 2802003



## HYBRID JACKET

- Sleeves in softshell waterproof and breathable 3000mm/3000g
- Body nylon downproof
- Padding 80 g
- Three external pockets with easy-grab puller

Black | S-3XL | 2802004



## RAIN JACKET

- Polyester ripstop high tearing resistance
- PU coating 1000 mm
- Mesh lining
- Non-removable hood

Black | S-3XL | 2802005



## **NEW** SF TECH GLOVES TOUCH CE

- CE-approved motorcycle glove EN 13594:2015
- Touch screen compatible
- Knuckle-protected
- Silicon print on fingers to improve grip
- Neoprene cuff with Velcro tightening
- Reinforcement patches for safety and comfort

Black | XS-7, 3XL-13 | 2802102

# RIDING GEAR



**NEW**

## OFF-ROAD RIDING JERSEYS

Mesh ventilated panels for maximum air flow  
Elastic sleeves with non-restrictive cuffs

**NEW**

## OFF-ROAD RIDING GLOVES

Adjustable wrist closure for a custom fit  
Silicon finger grips and neoprene knuckle protection



**BLACK**  
JERSEY | S-3XL | 2862718  
GLOVE | S-3XL | 2862726

**ORANGE**  
JERSEY | S-3XL | 2862719  
GLOVE | S-3XL | 2862729

**TEAL**  
JERSEY | S-3XL | 2862720  
GLOVE | S-3XL | 2862727

**GREEN**  
JERSEY | S-3XL | 2862721  
GLOVE | S-3XL | 2862730

**BLUE**  
JERSEY | S-3XL | 2862722  
GLOVE | S-3XL | 2862728

**YOUTH JERSEY**  
S-XL | 2862723

**YOUTH JERSEY**  
S-XL | 2862724

**YOUTH JERSEY**  
S-XL | 2862725



**SHORT SLEEVE**

Men's | S-3XL | 2860634  
Women's | S-3XL | 2860636

**LONG SLEEVE**

Men's | S-3XL | 2860638  
Women's | S-3XL | 2860640



**RAIN JACKET**

Gray | S-3XL | 2869527

**RAIN PANTS**

Gray | S-3XL | 2869528

**COOLING SHIRTS**

**FABRIC TECHNOLOGY DESIGNED TO KEEP YOU COOL**

- Chemical-free fabric, Coolcore reduces the surface temperature up to 30% so you don't overheat
- Carries a 50 Ultraviolet Protection Factor rating, blocking 98% of harmful UV rays



**RAIN JACKET & PANTS**

**PACKABLE WATERPROOF PROTECTION AGAINST UNPREDICTABLE WEATHER**

- 100% waterproof, lightweight and packable nylon
- YKK zippers
- Rain jacket has removable hood

# HELMETS

**FOR**  
**POLARIS**

**NEW**  
TAN  
XS-4XL  
2862472



# ALTITUDE

## 509 ALTITUDE 2.0 HELMET

LIGHTWEIGHT DESIGN, PERFORMANCE-INFUSED  
STYLE AND FEATURES WITH ALL-DAY COMFORT

### SHELL

- Strong, lightweight construction of carbon fiber or fiberglass

### WEIGHT

- Composite as low as 1,260g
- Carbon fiber as low as 1,150g

### FEATURES

- Superior fit for all-day comfort
- Removable Pro Series breath box provides excellent ventilation and air flow
- One-piece eyepoint creates draft-free seal with 509 goggles
- Magnetic Fidlock chin-strap technology and integrated GoPro mount
- DOT and ECE 22.05-approved

**FIDLOCK.**



BLACK  
XS-4XL  
2861469



BLACK/RED  
XS-4XL  
2861472



RED/BLACK  
XS-4XL  
2861470



CARBON FIBER  
BLACK/LIME  
XS-4XL | 2861473

**FOR**  
**POLARIS**

RED/BLACK  
XS-4XL  
2862467



# TACTICAL

## **NEW** TACTICAL 2.0 HELMET

BUILT FROM THE GROUND UP WITH INNOVATIVE  
FEATURES FOR ULTIMATE COMFORT AND CONTROL

### SHELL

- Shock-resistant, injection-molded thermoplastic

### FEATURES

- Venturi vent system generates negative pressure at velocity and pulls moist air from the breath box
- Integrated eyepoint seal is co-integrated with the breath box and creates a draft-free seal with 509 goggles for unparalleled warmth and clear field of view
- Magnetic Fidlock chin-strap technology
- DOT and ECE 22.06-approved

**FIDLOCK.**



MATTE BLACK  
XS-4XL  
2862468



GRAY  
XS-4XL  
2862469



LIME  
XS-4XL  
2862470



ORANGE  
XS-4XL  
2862471

# TENACITY

## TENACITY 4.0 HELMET

COMBINATION OF MODERN STYLE AND PREMIUM PROTECTION WITH INCREDIBLE VALUE

### SHELL

- Shock-resistant, injection-molded thermoplastic

### WEIGHT

- 1,500g

### FEATURES

- Through-flow, full-helmet ventilation
- ProClip quick release chin strap allows you to fasten the chin strap in seconds
- Removable breath box
- Tool-less adjustable roost shield
- Removable, washable liner
- DOT- and ECE 22.05-approved

LIME  
XS-2XL  
2861559



BLACK  
XS-2XL  
2861557

BLACK/GRAY  
XS-2XL  
2861558

BLACK/WHITE  
XS-2XL  
2861560

WHITE/RED  
XS-2XL  
2861561

PINK  
XS-2XL  
2861562

## GOGGLES



ORANGE  
2862561

LIME  
2862559

**NEW**

### 509 KINGPIN OFF-ROAD GOGGLE

PREMIUM MATERIALS, ATTRACTIVE PRICE



#### FEATURES

- Oversized spherical lens delivers optimal peripheral vision
- Metal tear-off posts provide strength and durability
- Quick-change technology allows you to run the best lens tint for conditions



BLUE  
2862562

STEALTH  
2862560

**NEW**

### 509 MX6 OFF-ROAD GOGGLE

SUPER WIDE FIELD OF VIEW, ENGINEERED FOR DIRT



#### FEATURES

- PC outer lens with anti-scratch coating, and internal anti-fog coating
- Outriggers with latch system for quick lens change
- 45mm strap with silicone to hold strap in place



BLACK  
2862557

RED/BLACK  
2862558

# MEN'S APPAREL

**BLACK**  
S-3XL | 2862569

**NEW**  
**RED**  
S-3XL | 2862451



**NAVY**  
S-3XL | 2862570



**BLACK**  
S-3XL | 2861434



**GRAY**  
S-3XL | 2861435

**NEW**  
**WORK VEST**

**RUGGED AND DURABLE VEST THAT'S IDEAL AS AN OUTDOOR LAYER**

- Coated with Durable Water Repellency (DWR) to provide water-resistance
- 3M Thinsulate for added warmth with brushed flannel trim
- Three outer pockets for storage

**SOFTSHELL JACKET**

**VERSATILE LIGHTWEIGHT JACKET THAT'S SURPRISINGLY WARM AND PERFECT FOR EVERYDAY WEAR**

- Casual jacket armed with rugged and warm features for everyday wear
- Superior DWR prevents precipitation from saturating the jacket's exterior
- Lined with 280g of soft fleece for warmth
- Removable hood and underarm venting, three external pockets and one internal chest pocket



**CHARCOAL**  
S-3XL | 2860865



**BRONZE**  
S-3XL | 2860864

**FLANNEL JACKET**

**SHERPA FLEECE LINED JACKET DELIVERS EXCEPTIONAL WARMTH AND COMFORT**

- Warm sherpa lined fleece material
- Insulation to keep you warm
- Plenty of storage for your valuables



**FOREST GREEN**  
S-3XL | 2860862



**GRAY**  
S-3XL | 2860863



**BLACK**  
S-3XL | 2861608

**WORK JACKET**

**WARM AND RUGGED JACKET THAT'S TOUGH FOR WORK AND STYLISH FOR PLAY**

- Coated with Durable Water Repellency (DWR) to provide water-resistance
- Built in action back for increased range of motion
- 80g 3M Thinsulate for added warmth with brushed flannel trim
- One inner and four outer pockets for storage



**NEW**  
**REVOLVE VEST**

REVERSIBLE

**DURABLE AND WARM REVERSIBLE VEST OFFERS TWO STYLES IN ONE**

- Durable windbreak outer fabric helps protect from the elements
- 140g 3M Thinsulate insulation keeps you warm in cold weather
- Reversible vest offers two unique styles in one



**BLUE/ORANGE**  
S-3XL | 2862566

**BLACK/GRAY**  
S-3XL | 2862565



**NEW**  
**WINDBREAKER JACKET**

**LIGHTWEIGHT, WINDPROOF JACKET THAT PROVIDES PROTECTION WHILE RIDING**

- 100% polyester windproof fabric
- Lightweight construction makes it easy to pack
- Three external pockets allow for maximum storage

Black | S-3XL | 2861541



**FORCE JACKET**

**PACKABLE JACKET OFFERS LIGHTWEIGHT PROTECTION, IDEAL FOR ANY ACTIVITY**

- 140g 3M Thinsulate
- Plenty of storage with two external hand pockets and one internal media pocket
- Rugged YKK zippers
- Great for travel, compacts into pocket

Black | S-3XL | 2861432



APPAREL

RACING COLLECTION

RIDING GEAR

HELMETS & GOGGLES

MEN'S APPAREL

WOMEN'S APPAREL

MERCHANDISE

# MEN'S APPAREL

**NEW**

## TITAN MID-LAYER

**EXTREMELY WARM YET BREATHABLE MID-LAYER, PERFECT FOR RIDING**

- 319g Polartec Thermal Pro rib sweater provides great warmth
- Quick drying moisture wicking helps keep you dry
- Breathable material moves sweat to the outer surface
- Nylon overlay is comfortable and light

BLUE/ORANGE  
S-3XL | 2862567



BLACK  
S-3XL | 2862568

**NEW**  
TAN

S-3XL | 2862450

RED/BLACK

S-3XL | 2862490



## NORTHSTAR MID-LAYER

**VERSATILE MID-LAYER CAN BE WORN ALONE OR AS AN EXTRA LAYER**

- 280g of breathable fleece for added warmth
- Offers durable protection against the elements with a wear-resistant polyester face and wind-block layer on chest
- Designed to fit under outer shell when riding

BLACK/RED  
S-3XL | 2862616

BLACK/GRAY  
S-3XL | 2869925

**NEW**

## JOURNEY HOODIE

BLACK  
S-3XL | 2862489

**DURABLE HOODIE DESIGNED FOR EVERY DAY WEAR**

- Keeps the elements out with snug, rib-knit waist and cuffs
- Mock neck collar provides added protection and warmth
- Durable blended material made of 80% cotton, 20% polyester



**TECH FULL-ZIP HOODIE**

■ **NEW** ■ Tan | S-3XL | 2862486  
 Gray | S-3XL | 2861493  
 Black/Blue | S-3XL | 2861494



**CREW SWEATSHIRT**

■ **NEW** ■ Black | S-3XL | 2862488  
 Green | S-3XL | 2861498  
 Navy | S-3XL | 2861497



**ICON HOODIE**

■ **NEW** ■ Gray | S-3XL | 2862487  
 Green | S-3XL | 2861495  
 Black | S-3XL | 2861496



**ICON LONG SLEEVE**

■ **NEW** ■ Gray/Red | S-3XL | 2862505  
 Black | S-3XL | 2861584  
 Blue | S-3XL | 2861585



**DASH LONG SLEEVE**

■ **NEW** ■ Gray | S-3XL | 2862504  
 Navy | S-3XL | 2861583  
 Black | S-3XL | 2861582



**CHECKERED LONG SLEEVE**

■ **NEW** ■ Red | S-3XL | 2862506  
 Gray | S-3XL | 2861587  
 Black | S-3XL | 2861586



**ICON TEE**

■ **NEW** ■ Green | S-3XL | 2862501  
 Black | S-3XL | 2861570  
 Blue | S-3XL | 2861571



**STAMP TEE**

■ **NEW** ■ Black | S-3XL | 2862496  
 Gray | S-3XL | 2861565  
 Green | S-3XL | 2861564



**CORE TEE**

■ **NEW** ■ Red | S-3XL | 2862502  
 Black | S-3XL | 2861572  
 Blue | S-3XL | 2861573

# MEN'S CAMO

## STEALTH CAMO HAT

Camo | One Size | 2861527

## NORTHSTAR MID LAYER

Camo | S-3XL | 2861542

## CAMO SOFTSHELL JACKET

Camo | S-3XL | 2861543



**NEW**

## CAMO REVOLVE VEST

Camo | S-3XL | 2862572



**NEW**

## PURSUIT HOODIE

Camo | S-3XL | 2862494



## CAMO NECK GAITER

Camo | One Size | 2861948



## CAMO TRUCKER HAT

Black | One Size | 2860613



## HUNTER ORANGE HAT

Orange | S/M | 2860892  
Orange | L/XL | 2862545



## HUNTER ORANGE BEANIE

Orange | One Size | 2862595

# MEN'S BALL CAPS



## ELLIPSE PATCH TRUCKER HAT

**NEW** Light Gray | One Size | 2862539  
 Gray | One Size | 2861531  
 Black | One Size | 2861533  
 Navy | One Size | 2861532

## **NEW** HIGHLAND CAP

Tan | One Size | 2860893  
 Gray | One Size | 2862544



## CORE CAP

**NEW** Gray | One Size | 2862594  
 Navy | One Size | 2861523  
 Black | One Size | 2861524



## TONAL HAT

Black/Red | One Size | 2861526  
 Navy | One Size | 2861525



## **NEW** CLASSIC CAP

Gray | One Size | 2862543  
 Navy | One Size | 2862597



## CHECKERED HAT

Blue | One Size | 2861520  
 Black | One Size | 2861522  
 Gray | One Size | 2861521



## RETRO CAP

**NEW** Navy | One Size | 2862538  
 Gray/Red | One Size | 2869542  
 Gray/Orange | One Size | 2861536

APPAREL

RACING COLLECTION

RIDING GEAR

HELMETS & GOGGLES

MEN'S APPAREL

WOMEN'S APPAREL

MERCHANDISE

# WOMEN'S APPAREL

**NEW**

**BLUE**

S-3XL | 2862460

**BLACK**

S-3XL | 2862563



**BLACK**

S-3XL | 2861437

**GRAY/BLUE**

S-3XL | 2861439

**BLUE**

S-3XL | 2862564

## SOFTSHELL JACKET

**LIGHTWEIGHT PERFORMANCE THAT'S SURPRISINGLY WARM AND PERFECT FOR EVERYDAY WEAR**

- Superior DWR prevents precipitation from saturating the jacket's exterior
- Lined with 280g of soft fleece for warmth
- Removable hood and underarm venting, three external pockets and one internal chest pocket

**NEW**

## WORK JACKET

**WARM AND RUGGED JACKET THAT'S TOUGH FOR WORK AND STYLISH FOR PLAY**

- Coated with DWR to provide water-resistance
- Built-in action back for increased range of motion
- 80g 3M Thinsulate for added warmth with brushed flannel trim
- One inner and four outer pockets for storage



**BLACK**

S-3XL | 2862457

**DUSTY ROSE**

S-3XL | 2862456



**BLACK**

S-3XL | 2861433



**BLACK/GRAY**

S-3XL | 2862458

**DUSTY ROSE**

S-3XL | 2862459

**NEW**

## REVOLVE VEST

**DURABLE AND WARM REVERSIBLE VEST OFFERS TWO STYLES IN ONE**

- Durable windbreak outer fabric protects you from the elements
- 140g 3M Thinsulate insulation keeps you warm in cold weather
- Reversible vest offers two unique styles in one

## FORCE JACKET

**PACKABLE JACKET OFFERS LIGHTWEIGHT PROTECTION, IDEAL FOR ANY ACTIVITY**

- 140g 3M Thinsulate
- Plenty of storage with two external hand pockets and one internal media pocket
- Rugged YKK zippers
- Great for travel, compacts into pocket

## TITAN MID-LAYER

**EXTREMELY WARM YET BREATHABLE MID-LAYER, PERFECT FOR RIDING**

- 319g Polartec Thermal Pro rib sweater provides great warmth
- Quick drying moisture wicking helps keep you dry
- Breathable material moves sweat to the outer surface
- Nylon overlay is comfortable and light



**NEW**

**PURSUIT HOODIE**

Camo | S-3XL | 2862517



**NEW**

**JOURNEY HOODIE**

Black | S-3XL | 2862515  
Blue | S-3XL | 2862516



**TECH FULL-ZIP HOODIE**

Maroon | S-3XL | 2861509  
Gray | S-3XL | 2861508



**ICON HOODIE**

**NEW** White | S-3XL | 2862512  
Black | S-3XL | 2861506  
Maroon | S-3XL | 2861507



**NEW**

**ADVENTURE CREW**

Dusty Rose | S-3XL | 2862513  
Black | S-3XL | 2862514



**NEW**

**ADVENTURE TEE**

Teal | S-3XL | 2862629  
Black Frost | S-3XL | 2862628



**THINK OUTSIDE TEE**

**NEW** Pink | S-3XL | 2862518  
Black | S-3XL | 2861590  
Blue | S-3XL | 2861591

# MERCHANDISE



## STEEL SIGN

35.6 cm x 91.4 cm | 2860868

## ALUMINUM SIGN

55.9 cm | 2860867

## WOOD SIGN

26.7 cm x 61 cm | 2860866



## PINT GLASSES (SET OF 2)

2860815



## 12oz CAMPER MUG

2861612



## 17oz WATER BOTTLE

2861611



## **NEW** 23oz WATER BOTTLE

2862685



## 15oz CAMPFIRE MUG

2861613



## KEYCHAIN

2861614



## LEATHER LOOP KEYCHAIN

2861615



## **NEW** LICENSE PLATE HOLDER

2862687





**NEW**  
KICKBACK ROCKER  
2862626



**NEW**  
FREESTYLE ROCKER  
2862625



**NEW**  
EASY CHAIR  
2862627



**NEW**  
QUICK-E-SEAT  
2862624



**NEW**  
FOLDING TABLE  
2861620



**NEW**  
POLARIS PARKING  
SIGN  
2869934



**NEW**  
POLARIS FLAG  
91.4 cm x 152.4 cm | 2869928



**NEW**  
HITCH COVER  
2861623



# FIND YOUR NEXT ADVENTURE



Availability varies by market; check your local dealer for availability. Images taken on private land. The use of vehicles in similar environments in your jurisdiction may be prohibited per locally applicable laws and regulations. Campfires in similar environments in your jurisdiction may be prohibited per locally applicable laws and regulations. Keep your campfire safe, and make sure you can control it at all times. Know your locally applicable laws and regulations. Crossing water in similar environments may be prohibited in your jurisdiction.

Warning: Polaris off-road vehicles can be hazardous to operate and are not intended for on-road use. Driver must be at least 16 years old with a valid driver's license to operate. All riders should always wear helmets, eye protection and protective clothing and footwear. Read, understand and follow your owner's manual. Ride within the limits of your own abilities and never engage in stunt or exhibition driving. Never ride under the influence of drugs or alcohol. All riders should take a safety training course. Call 800-342-3784 for additional information.

UNLESS NOTED, TRADEMARKS ARE THE PROPERTY OF POLARIS INDUSTRIES INC. 3M<sup>®</sup> and 3M Insulate<sup>®</sup> are registered trademarks of 3M Company. 508<sup>®</sup> is a registered trademark of Teton Outfitters, LLC. Apple<sup>®</sup> is a registered trademark of Apple Inc. Apple Store<sup>®</sup> is a registered trademark of Apple Inc. Bose<sup>®</sup> is a registered trademark of Bose Corporation. Bluetooth<sup>®</sup> is a registered trademark of Bluetooth SIG, Inc. Caliber<sup>®</sup> is a registered trademark of Caliber, Inc. Camp Chef<sup>®</sup> is a registered trademark of CAMPSIDE INC. COOLCORE<sup>®</sup> is a registered trademark of COOLCORE LLC. Facebook<sup>®</sup> is a registered trademark of Facebook, Inc. Fidlock<sup>®</sup> is a registered trademark of Fidlock GmbH. FOX<sup>®</sup> is a registered trademark of Fox Factory Inc. Google Play<sup>®</sup> is a registered trademark of Google, Inc. GoPro<sup>®</sup> is a registered trademark of GoPro, Inc. Instagram<sup>®</sup> is a registered trademark of Instagram, LLC. Kolpin<sup>®</sup> is a registered trademark of Polaris Industries Inc. Pandora<sup>®</sup> is a registered trademark of Pandora Media, LLC. Palartec<sup>®</sup> is a registered trademark of MMI-TPCO, LLC. RHINO-RACK<sup>®</sup> is a registered trademark of Rhino Rack Australia Pty Limited. RIGID<sup>®</sup> is a trademark of JST Performance, LLC d/b/a Rigid Industries. Rockford Fosgate<sup>®</sup> is a registered trademark of Rockford Corporation. SMART BOARD<sup>®</sup> is a registered trademark of MARTI TECHNOLOGIES ULC UNLIMITED LIABILITY CORPORATION CANADA. TEKVEST<sup>®</sup> is a registered trademark of TIGER IS ONTARIO INC. The Dryline<sup>®</sup> is a registered trademark of TIGER COATINGS GMBH & CO. Twitter<sup>®</sup> is a registered trademark of Twitter, Inc. WALKER EVANS RACING<sup>®</sup> is a registered trademark of Walker Evans Enterprises Incorporated. Yeti<sup>®</sup> is a registered trademark of Yeti Coolers, LLC. YKK<sup>®</sup> is a registered trademark of YKK Corporation. YouTube<sup>®</sup> is a registered trademark of Google Inc. Prices, Fitment and Availability are subject to change at any moment. Copyright © 2021 Polaris Industries Inc. All rights reserved.



ELEVATE YOUR  
**ADVENTURE**



**POLARIS**

MY22 GENERAL APP ACC EMEA