

EMEA VERSION

POLARIS

RZR

POPP

ACCESSORIES + APPAREL



OUTRUN THE ORDINARY



#RZRLife

LIVE THE LIFESTYLE.
JOIN THE COMMUNITY.

2022 LINEUP

TRAIL

TRAIL S & TRAIL P. 34



RZR TRAIL S

570 P. 86



RZR 570

MULTI-TERRAIN

PRO XP P. 04



RZR PRO XP SPORT



RZR PRO XP ULTIMATE

XP 1000 & RS1 P. 22



RZR XP 1000



RZR XP 4 1000

YOUTH

P. 87

CONTENTS

PRO XP 04

AUDIO	08
WINDSHIELDS & REAR PANELS	10
ROOFS, DOORS & HEATER	12
VEHICLE PROTECTION & LIGHTING	14
STORAGE	16
MISC, MIRRORS & WINCHES.....	18
ACCESSORIZE.....	20

TURBO S & XP 22

WINDSHIELDS & REAR PANELS	24
ROOFS & DOORS	26
VEHICLE PROTECTION & WINCHES.....	28
STORAGE & MIRRORS.....	30
RS1 ACCESSORIES	32

TRAIL 34

WINDSHIELDS & REAR PANELS	38
ROOFS, DOORS & AUDIO.....	40
VEHICLE PROTECTION & STORAGE	42
WINCHES, HEATER & PLOWS	44
LIGHTING & ELECTRICAL & TRACKS	46
ACCESSORIZE	96

2014-2020 TRAIL 50

COMMON ACCESSORIES 52

LIGHTING	52
CONNECTED TECHNOLOGY	58
AUDIO	60
PRO ARMOR WHEELS & TIRES.....	62
VEHICLE & RIDER PROTECTION	78
POLARIS NORTHSTAR COOLERS	80
COCKPIT ACCESSORIES & MIRRORS.....	82
WINCHES.....	84
ADDITIONAL ACCESSORIES & 570	86

YOUTH 87

PARTS & GARAGE 88

MAINTENANCE	88
OIL & LUBRICANTS	90
HD PARTS.....	92
SERVICE PARTS	94
CLEANERS & TRAILERING	96

APPAREL 98

RACING COLLECTION	98
RIDING GEAR	100
HELMETS & GOGGLES	102
MEN'S APPAREL	104
WOMEN'S APPAREL	112
MERCHANDISE	114



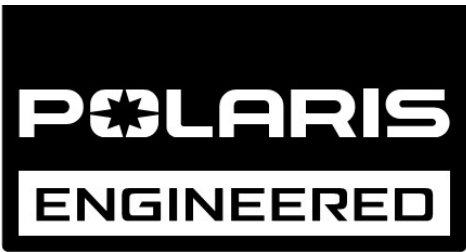

DESIGNED

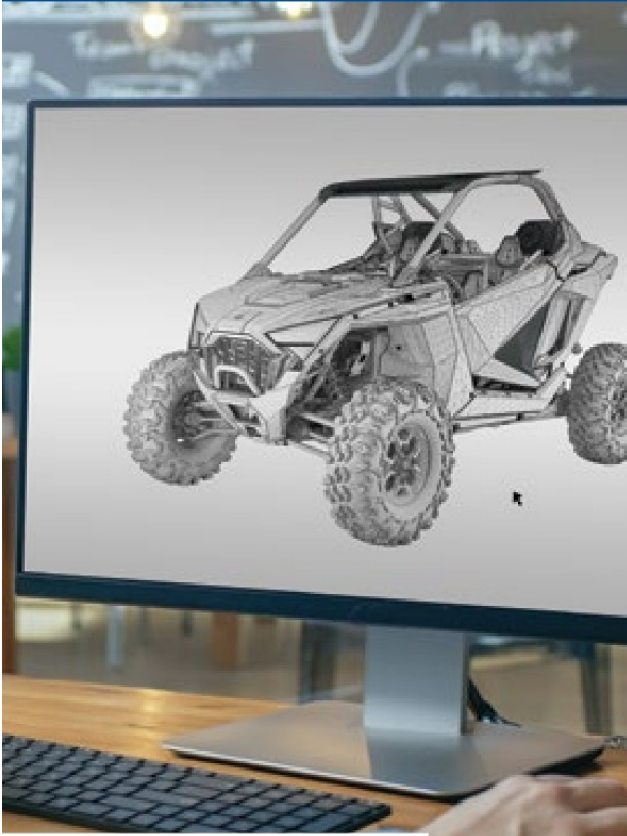

Designed by the same people who designed your vehicle.

TESTED



Extensively tested in the field so you ride with 100% confidence.

WE HOLD OUR PARTNERS TO THE SAME STANDARDS



PREMIUM AFTERMARKET OPTIONS
DESIGNED WITH POLARIS TO
MAXIMIZE PERFORMANCE
P. 57, 62



A GLOBAL LEADER IN AUDIO
INNOVATION, DESIGN &
ENGINEERING
P. 08, 41

KEEP YOUR STANDARDS HIGH. WE DO.

TRUSTED



65 years in the business.
The #1 name in Off-Road.

MBQUART

IGNITE AND FUEL YOUR
PASSION FOR PRECISE QUALITY
SOUND REPRODUCTION
P. 60

RIGID

PRODUCTS SO GOOD
THEY REPLACE OR REPAIR
THEM FOR LIFE
P. 15, 56



MILITARY-GRADE AIR FILTRATION
THAT KEEPS YOUR AIR FILTER CLEAN
AND ENGINE PROTECTED.
P. 18

ASSAULT
INDUSTRIES

RACE PROVEN.
TRAIL READY.
P. 18

PRO XP

POLARIS
RZR PRO XP



CONQUER
ANY TERRAIN



> UNMATCHED ENGINEERING

Next-level innovation makes this RZR unlike anything you've ever owned.

Rockford Fosgate Audio P. 08
RIDE COMMAND P. 08
RIGID Lighting P. 15
Polaris PULSE P. 15
Integrated Winch P. 19



PLUG & PLAY ELECTRICAL

EFFORTLESSLY ADD LIGHTS, AUDIO & WINCH



> VISIONARY DESIGN

Relentless attention to detail delivers extraordinary style and function for the ultimate ride.

Windshields P. 11
Roofs P. 12
Doors P. 13
Mirrors P. 18



> ELEVATED FUNCTIONALITY

An unrivaled selection of accessories gives you even more reason to get out - and stay out - riding.

Protection P. 14
Storage P. 16
Wheels & Tires P. 62

PRO XP

AUDIO

WINDSHIELDS & REAR PANELS

ROOFS, DOORS & HEATER

VEHICLE PROTECTION & LIGHTING

STORAGE

MISC. ACCESSORIES & WINCHES

RIDER ACCESSORY COLLECTIONS



DESERT



TRAIL

Dominate the rocky landscape and charge through endless miles of desert.



Navigate the trails and soak up the old-growth groves, forests, plains and waterways.



2889019	FULL VENTED WINDSHIELD - GLASS	P. 11
2883962	GLASS WINDSHIELD WIPER KIT	P. 11
2883743-458	ALUMINUM ROOF	P. 12
2883749-458	FRONT HIGH COVERAGE BUMPER	P. 14
2884189-458	REAR HIGH COVERAGE BUMPER	P. 14
2884359	RIGID CHASE LIGHT	P. 15
2884896	CHASE LIGHT MOUNT KIT	P. 15
2889034	CHASE LIGHT HARNESS	P. 15
2883751	70L FORWARD CARGO BOX	P. 16
2884623	23 QT REAR COOLER	P. 17
2884666	MULTI-PASSENGER REAR SEAT CARGO BOX	P. 17
2884907-458	PIVOTING SPARE TIRE CARRIER	P. 17

Shown on Pro XP 4-Seat.

2883756	FULL VENTED WINDSHIELD - HARD COAT POLY	P. 11
2883928	POLY SPORT ROOF	P. 12
2883765	DOOR CLOSOFFS*	P. 13
2883749-458	FRONT HIGH COVERAGE BUMPER	P. 14
2884189-458	REAR HIGH COVERAGE BUMPER	P. 14
2889208-458	KICK-OUT ROCK SLIDERS	P. 14
2883751	70L FORWARD CARGO BOX	P. 16
2883752	REAR CARGO BOX	P. 16
2884304	7.25L DOOR STORAGE BAG	P. 17
2884907-458	PIVOTING SPARE TIRE CARRIER	P. 17
2883758	POLARIS PRO HD 4,500 LB WINCH	P. 19

Shown on Pro XP 2-Seat.

*Door Closeoffs come stock on Premium and Ultimate trims

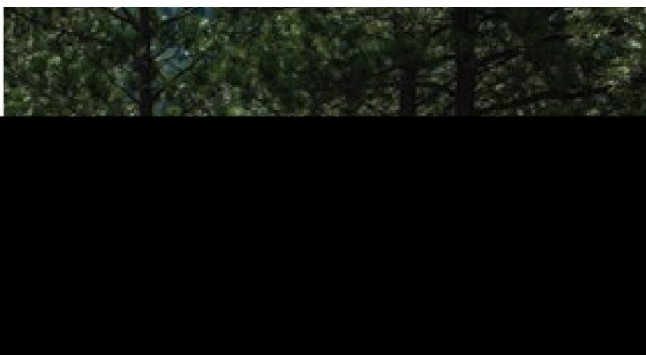

Safely climb pristine mountain trails for an epic view.



2889019	FULL VENTED WINDSHIELD - GLASS	P. 11
2883928	POLY SPORT ROOF	P. 12
2883749-458	FRONT HIGH COVERAGE BUMPER	P. 14
2884189-458	REAR HIGH COVERAGE BUMPER	P. 14
2889208-458	KICK-OUT ROCK SLIDERS	P. 14
2883752	40L REAR COOLER	P. 16
2884304	7.25L DOOR STORAGE BAG	P. 17
2884907-458	PIVOTING SPARE TIRE CARRIER	P. 17
2883758	POLARIS PRO HD 4,500 LB WINCH	P. 19

Shown on Pro XP 2-Seat.

Take advantage of any season with year-round riding.



2889536	TIP OUT WINDSHIELD - HARD COAT POLY	P. 11
2883757	POLY REAR PANEL	P. 11
2883743-458	ALUMINUM ROOF	P. 12
2884664	CANVAS UPPER HALF DOORS	P. 13
2884658	FRONT DOOR INNER CLOSEOFF PANELS	P. 13
2883749-458	FRONT HIGH COVERAGE BUMPER	P. 14
2884189-458	REAR HIGH COVERAGE BUMPER	P. 14
2884685	FULL COVERAGE FENDER FLARES	P. 14
2884386	HEATER KIT	P. 13

Shown on Pro XP 2-Seat.

PRO XP

A NEW AUDIO EXPERIENCE



Rockford Fosgate partnered with Polaris to create the next evolution of factory-installed off-road audio. Purpose-built to stand up to any outdoor environment and designed to perform no matter the ride. Specifically tuned and rider-centric to create an audio experience that is second to none.



PLUG & PLAY



ELEMENT READY



NO LOSS OF CARGO SPACE



BLUETOOTH

SOURCE UNITS

- Designed specifically for the Pro XP platform
- Tuned to combat wind and motor noise, delivering an incredible sound no matter the speed
- Element ready design guards against dust and moisture intrusion

AMPLIFIERS

- Ultra Compact CLEAN technology
- Highly efficient design capable of being pushed hard without overheating

SPEAKERS

- Off-Road Optimized Element Ready speakers that thrive in any outdoor environment
- Specifically tuned enclosures create rich cockpit sound
- Rugged, yet lightweight, materials that don't sacrifice speed for sound

SUBWOOFERS

- High-power, high-excursion subwoofer that acoustically couples with the cockpit for perfect bass response
- Torture tested to ensure long life and performance

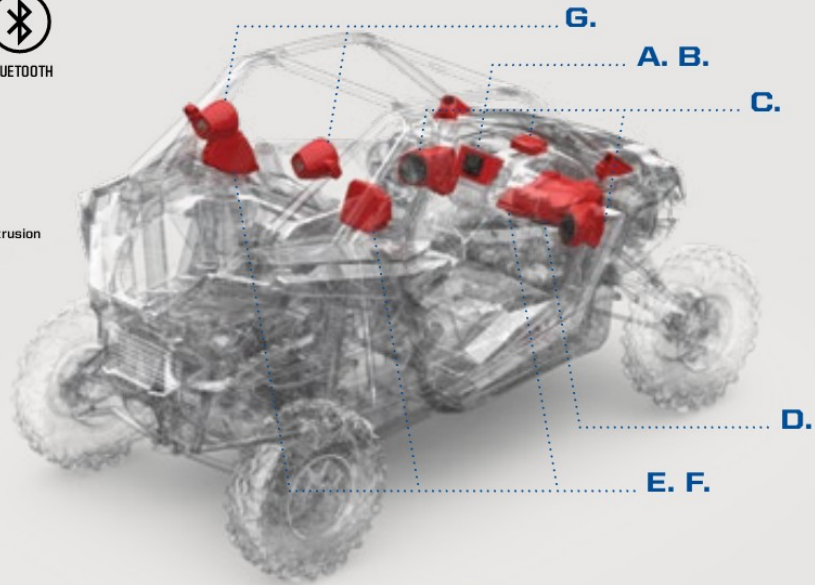

A. 7" DISPLAY POWERED BY RIDE COMMAND

2884072
PRO XP 4 '20-22, PRO XP '20-22
REQUIRES MOUNT KIT 2884584

SEE P. 58 FOR FULL RIDE COMMAND DETAILS



B. PMX-2 HEAD UNIT

- 6.88 cm full color display
- AM/FM/WB tuner*
- Pandora control
- Bluetooth connectivity
- Includes mount kit

2883964
PRO XP 4 '20-22, PRO XP '20-22
NOT COMPATIBLE WITH PRO XP ULTIMATE AND PREMIUM



C. STAGE 2 TOP SELLER FULL RANGE AMPLIFIER AND FRONT UNDER-DASH SPEAKERS

- 400 watt full range amplifier
- 50 watt 16.51 cm component speakers including tweeters with enclosures

2883943
PRO XP 4 '20-22, PRO XP '20-22
STANDARD ON PRO XP ULTIMATE AND PREMIUM



D. STAGE 3 25.4 cm POWERED SUBWOOFER UPGRADE

- 400 watt 25.4 cm subwoofer with enclosure and grille
- 400 watt integrated subwoofer amplifier

2883857
PRO XP 4 '20-22, PRO XP '20-22



E. STAGE 4 25.4 cm POWERED SUBWOOFER WITH REAR COAXIAL SPEAKER UPGRADE

- 400 watt 25.4 cm subwoofer with enclosure and grille
- 400 watt integrated subwoofer amplifier
- 50 watt 16.51 cm coaxial speakers with enclosures and grilles

2884655
PRO XP 4 '20-22, PRO XP '20-22



F. STAGE 5 30 cm POWERED SUBWOOFER WITH FULL SYSTEM SPEAKER UPGRADE

- 400 watt 30 cm subwoofer with enclosure and grille
- 400 watt integrated subwoofer amplifier
- 100 watt 16.51 cm coaxial speakers with enclosures and stainless steel grilles
- 100 watt 16.51 cm front component replacement speakers
- High output tweeters with stainless steel grilles
- 2x more power and sound delivery over the stock system

2889463
PRO XP 4 '20-22, PRO XP '20-22
COMPATIBLE WITH ULTIMATE AND PREMIUM ONLY
NOT COMPATIBLE WITH REAR PODS (2883945)
SUBWOOFER ADDITION ELIMINATES GLOVE BOX STORAGE
'20-21 PRO XP REQUIRES REAR AUDIO HARNESS (2415152), SOLD SEPARATELY



G. REAR PODS USE WITH STAGE 2, STAGE 3 OR STAGE 4

- 50 watt 16.51 cm coaxial speakers with can-enclosures, mounting hardware and grilles
- Stage 2 and 3 require Audio Harness (2415152), sold separately

2883945
PRO XP 4 '20-22, PRO XP '20-22
NOT COMPATIBLE WITH ROCKFORD FOSGATE ULTIMATE LE MODELS

*The FM Frequency range is from 88 to 108 and only on the odds (i.e. 88.1, 88.3, etc.).



> AUDIO

PRO XP

AUDIO

WINDSHIELDS
& REAR PANELS

ROOFS, DOORS
& HEATER

VEHICLE PROTECTION
& LIGHTING

STORAGE

MISC. ACCESSORIES
& WINCHES

BUILD YOUR SOUND

(CHOOSE THE PATH THAT MATCHES YOUR RZR)

FACTORY-INSTALLED

SKIP TO STEP 3



**PRO XP
SPORT LE**

2-SEAT PMX-P2 + STAGE 1	4-SEAT PMX-P2 + STAGE 1 AND REAR SPEAKERS
----------------------------------	---



**PRO XP
PREMIUM & ULTIMATE**

2-SEAT RIDE COMMAND + STAGE 2	4-SEAT RIDE COMMAND + STAGE 2 AND REAR SPEAKERS
--	---

NO FACTORY AUDIO

STEP 1

SELECT HEAD UNIT

**PMX-2
HEAD UNIT**

2883964

PRO XP 4 '20-22, PRO XP '20-22

NOT COMPATIBLE WITH PRO XP
ULTIMATE OR PREMIUM

**MOUNT KIT
INCLUDED**

**7" DISPLAY WITH
RIDE COMMAND**

2884072

PRO XP 4 '20-22, PRO XP '20-22

MOUNT KIT REQUIRED

2884584

PRO XP 4 '20-22, PRO XP '20-22

SEE P. 58 FOR FULL
RIDE COMMAND DETAILS

STEP 2

ADD AUDIO KIT

STAGE 2

FULL RANGE AMPLIFIER AND FRONT UNDER-DASH SPEAKERS

2883943

PRO XP 4 '20-22, PRO XP '20-22 - STANDARD ON PRO XP ULTIMATE AND PREMIUM

STEP 3

UPGRADE AUDIO

**PRO XP
SPORT LE ONLY
AMP UPGRADE
KIT**

2884908

PRO XP 4 SPORT LE '21-22,
PRO XP SPORT LE '21-22

**REQUIRED FOR ANY SPORT LE TO
UPGRADE TO STAGE 3 OR STAGE 4**

STEP 3

UPGRADE AUDIO

STAGE 3

**25.4 cm POWERED
SUBWOOFER
UPGRADE**

2883857

PRO XP 4 '20-22, PRO XP '20-22

NOT COMPATIBLE WITH STAGE 4

STAGE 4

**25.4 cm POWERED
SUBWOOFER WITH REAR
COAXIAL
SPEAKER UPGRADE**

2884655

PRO XP 4 '20-22, PRO XP '20-22

NOT COMPATIBLE WITH STAGE 3

ALL 4-SEAT MODELS WITH FACTORY AUDIO
INCLUDE REAR SPEAKERS

REAR PODS

2883945

PRO XP 4 '20-22, PRO XP '20-22
NOT COMPATIBLE WITH ROCKFORD FOSGATE
ULTIMATE LE MODELS

ADD TO STAGES 1-4

**REAR SPEAKER POD
AUDIO HARNESS**

2415152

REQUIRED FOR STAGES 1-3

PRO XP 4 '20-22, PRO XP '20-22

AUDIO HARNESS NOT REQUIRED ON PRO XP 4
MODELS WITH FACTORY INSTALLED REAR SPEAKERS
AUDIO HARNESS STANDARD ON 2022 MODELS

OR

PRO XP
PREMIUM & ULTIMATE

NEW STAGE 5

**30 cm POWERED SUBWOOFER WITH FULL
SYSTEM SPEAKER UPGRADE**

2889463

PRO XP 4 '20-22, PRO XP '20-22 PREMIUM OR ULTIMATE MODELS ONLY
'20-21 PRO XP REQUIRES REAR AUDIO HARNESS (2415152), SOLD SEPARATELY

NOT COMPATIBLE WITH REAR PODS (2883945), STAGE 3 OR STAGE 4

PRO XP



> BUILD YOUR CAB

ADD COMFORT AND STYLE WITH END-TO-END PROTECTION

ADD A WINDSHIELD

Protect all riders with optical clarity.

ADD A ROOF

Shield from harsh elements while adding style.

ADD A REAR PANEL

Maintain rear visibility while reducing rear air swirl.



ADD DOORS

Keep the cab free of debris and water.

RECOMMENDED 2-SEAT CAB

2889019	FULL VENTED WINDSHIELD - GLASS
2883962	GLASS WINDSHIELD WIPER KIT
2883757	POLY REAR PANEL
2883928	POLY SPORT ROOF
2884664	CANVAS UPPER HALF DOORS
2884658	FRONT DOOR INNER CLOSEOFF PANELS

Available on 2-Seat and 4-Seat vehicles.

RECOMMENDED 4-SEAT CAB

2884305	FULL VENTED WINDSHIELD - HARD COAT POLY
2884147	POLY REAR PANEL
2883990-458	ALUMINUM ROOF
2884660-458	ALUMINUM DOORS
2884665	CANVAS UPPER HALF DOORS

Available on 2-Seat and 4-Seat vehicles.



POLARIS ENGINEERED ADVANTAGES



LOCK & RIDE

REVOLUTIONARY INSTALLATION

Lock & Ride clamps make for easy on-off and eliminate the risk of cracking.



GASKETED SEAL

Keeps drafts and moisture out. Reduces ride chatter on full glass windshields.

WINDSHIELDS

GLASS

HARD COAT POLY



WIPER READY

FULL VENTED WINDSHIELD - GLASS

TOP SELLER

- Double-layer, laminated and tempered glass windshield with steel, powder-coated frame and adjustable center vent

» 2889019

PRO XP 4 '20-22, PRO XP '20-22
NOT COMPATIBLE WITH LIGHT POCKET ALUMINUM ROOF (2883961, 2883991)



LOCK & RIDE

FULL VENTED WINDSHIELD - HARD COAT POLY

- Impact-resistant, long-lasting .64 cm durable hard coated polycarbonate
- Full protection with airflow vents that quickly open for cockpit ventilation

» 2884305

PRO XP 4 '20-22, PRO XP '20-22
COMPATIBLE WITH ALUMINUM ROOF ONLY (2883961, 2883743, 2883991, 2883990)

» 2883756

PRO XP 4 '20-22, PRO XP '20-22
COMPATIBLE WITH POLY SPORT ROOF ONLY (2883928, 2883946)



TIP OUT WINDSHIELD - HARD COAT POLY

- Hard coated polycarbonate panel windshield with closed, vented and fully open positions

» 2889536

PRO XP 4 '20-22, PRO XP '20-22
NOT COMPATIBLE WITH LIGHT POCKET ALUMINUM ROOF (2883961, 2883991)



GLASS WINDSHIELD WIPER KIT

- Simple to control with a multi-speed, dash-mounted switch
- Includes a washer fluid reservoir

» 2883962

PRO XP 4 '20-22, PRO XP '20-22
COMPATIBLE WITH GLASS WINDSHIELD ONLY



LOCK & RIDE

HALF WINDSHIELD - HARD COAT POLY, MID

- Impact-resistant, long-lasting .64 cm durable hard coated polycarbonate
- Provides both protection and airflow into the cab
- 30.48 cm tall

» 2884966

PRO XP 4 '20-22, PRO XP '20-22



LOCK & RIDE

HALF WINDSHIELD - HARD COAT POLY, LOW

- Provides added protection from the elements, while allowing optimum airflow and visibility

• 12.7 cm tall

» 2884746

PRO XP 4 '20-22, PRO XP '20-22

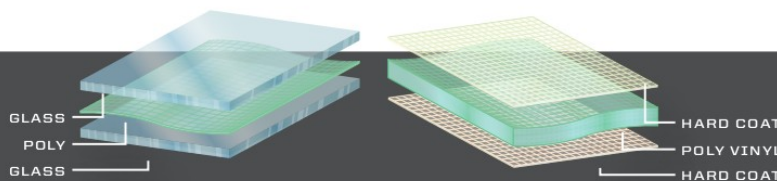

GLASS VS HARD COAT POLY

- Superior optical clarity (automotive level)
- Scratch-resistant
- Seals tight
- Cold weather/heavy duty

- Lightweight, flexible, easy to store/remove
- Impact-resistant
- 30x more scratch resistance than regular poly windshields

REAR PANEL



LOCK & RIDE

POLY REAR PANEL

- Drape formed 3mm polycarbonate for lightweight, impact-resistant durability
- Maintains rear visibility and reduces rear air swirl from entering the cockpit
- Fully compatible with all accessories
- If installed, Rear Audio Pods should project backwards

2-SEAT

2883757

PRO XP '20-22

4-SEAT NET SHOWN

2884147

PRO XP 4 '20-22

PRO XP

AUDIO

WINDSHIELDS & REAR PANELS

ROOF, DOORS & HEATER

VEHICLE PROTECTION & LIGHTING

STORAGE

MISC. ACCESSORIES & WINCHES

PRO XP

> ROOFS

POLY

POLY SPORT ROOF

- Durable, lightweight polypropylene with contoured design for water run-off
- Maximum protection with full seal for a leak-free barrier and reduced chatter

COLOR	2-SEAT	4-SEAT	NOT SHOWN
■ MATTE BLACK	2883928	2883946	
	PRO XP '20-22	PRO XP 4 '20-22	

ALUMINUM

ALUMINUM ROOF

- .32 cm lightweight aluminum stamped sheet with full seal for a leak-free barrier and vibration elimination
- Quick install, low-profile design with maximum protection and durability from the harshest conditions

COLOR	2-SEAT	4-SEAT	NOT SHOWN
■ MATTE BLACK	2883743-458	2883990-458	
■ INDY RED	2883743-293	2883990-293	
■ ZENITH BLUE	2883743-849	2883990-849	
	PRO XP '20-22	PRO XP 4 '20-22	

LIGHT POCKET ALUMINUM ROOF

- .32 cm lightweight aluminum stamped sheet with full seal for a leak-free barrier and vibration elimination
- Low-profile with light pocket
- Quick installation with maximum protection and durability from the harshest conditions
- Not compatible with Full Vented Windshield - Glass (2889109) or Tip Out Windshield - Hard Coat Poly (2889536)

COLOR	2-SEAT	4-SEAT	NOT SHOWN
■ MATTE BLACK	2883961-458	2883991-458	
	PRO XP '20-22	PRO XP 4 '20-22	

ADD THE 71.12 cm RIGID SINGLE ROW LED LIGHT BAR, WHICH FITS PERFECTLY INTO THE ROOF POCKET. SEE P. 15 FOR MORE DETAILS



VISIONARY DESIGN

Relentless attention to detail delivers extraordinary style and function for the ultimate ride.

ALUMINUM VS HARD COAT POLY

- High protection strength
- Lower profile
- Sleek style

- Water run-off
- Pre-existing mounting features
- Lightweight



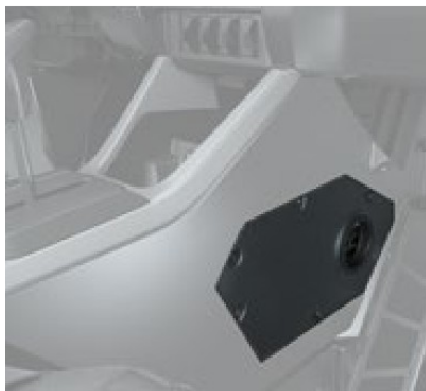

> DOORS

DOOR CLOSEOFFS

- Lightweight plastic door closeoffs provide riders protection from mud, rocks and water
- Quick installation and seamless fit into door opening
- Retains front ventilation

► 2883765

PRO XP '20-22

STANDARD ON PRO XP 4, PREMIUM/ULTIMATE PRO XP

ALUMINUM DOORS

- 12-gauge thick, stamped aluminum with full lower coverage and seal to keep out water, mud, dust and debris
- Uses factory door frames, with 4-Seat option providing an additional seal between front and rear doors
- Compatible with Front Door Inner Closeoff Panels (2884658, 2884831) and Canvas Upper Half Doors (2884664, 2884665)

COLOR	2-SEAT <small>NOT SHOWN</small>	4-SEAT
■ MATTE BLACK	2884659-458 PRO XP '20-22	2884660-458 PRO XP 4 '20-22 NOT COMPATIBLE WITH LOW PROFILE ROCK SLIDERS (2883987)

FRONT DOOR INNER CLOSEOFF PANELS

- Vacuum formed polyethylene with full lower coverage and seal that keeps out water, mud, dust and debris
- Built-in armrest
- 2-Seat option maintains color accent boomerang
- Compatible with Door Closeoffs (2883765) and Aluminum Doors (2884659-458, 2884660-458)

► 2-SEAT • 2884658

PRO XP '20-22

NOT COMPATIBLE WITH ROCK SLIDERS (2883760, 2883997)

► 4-SEAT • 2884831 NOT SHOWN

PRO XP 4 '20-22

NOT COMPATIBLE WITH ROCK SLIDERS (2883987, 2883988)

CANVAS UPPER HALF DOORS

- High quality compression molded doors nest into thermoformed high-density polyethylene side shrouds for excellent sealing
- Includes zip-down 30-gauge clear vinyl windows
- Provides profiled cab edge for superior fit and finish
- Includes seals for key closeoff areas

► 2-SEAT • 2884664

PRO XP '20-22

► 4-SEAT • 2884665 NOT SHOWN

PRO XP 4 '20-22

SOME DRIVERS MAY EXPERIENCE PASSENGER SIDE MIRROR OBSTRUCTION WHEN USED WITH UPPER HALF DOORS. USE WITH CAUTION.

> HEATER

HEATER KIT

- Connects to Polaris PULSE bus bar to provide reliable, steady heat to your cab with fan speed and temperature control
- Closeable driver and passenger floor vents and electronic demist vent shutoff

► 2884386

PRO XP 4 '20-22, PRO XP '20-22

PRO XP

AUDIO

WINDSHIELDS
& REAR PANELS

ROOF, DOORS
& HEATER

VEHICLE PROTECTION
& LIGHTING

STORAGE

MISC. ACCESSORIES
& WINCHES

CHOOSE YOUR DOOR

ADD DOOR ACCESSORIES

PRO XP

> BUMPERS / FENDER FLARES



LOW PROFILE BUMPER

- Durable, powder-coated 3.8 cm - 4.5 cm tube steel with sleek lower profile

COLOR	FRONT	REAR
■ MATTE BLACK	2883746-458	2883748-458
■ INDY RED	2883746-293	2883748-293
■ BLUE METALLIC	2883746-751	2883748-751

PRO XP 4 '20-22, PRO XP '20-22
BUMPER BRACKET (2889566) REQUIRED FOR FRONT LOW PROFILE BUMPER (2883746-XXX) WHEN USED ON PRO XP SPORT '22

HIGH COVERAGE BUMPER

- Durable 12-gauge, powder-coated steel with extended high-coverage design for maximum vehicle protection

COLOR	FRONT	REAR
■ MATTE BLACK	2883749-458	2884189-458
■ INDY RED	2883749-293	2884189-293
■ ZENITH BLUE	2883749-849	2884189-849

PRO XP 4 '20-22, PRO XP '20-22

INTEGRATED WINCH SEE P. 19



RIGID 15.24 cm LIGHT BAR SEE P. 15



Next-level style and function. Front bumpers are designed to effortlessly integrate a winch or 15.2 cm RIGID light bar.



FULL COVERAGE FENDER FLARES

- Covers the rear body opening to prevent mud from flying into the vehicle
- Maximum protection with 15.2 cm of additional coverage and extended, removable mud flaps
- Front and rear included

» 2884685
PRO XP 4 '20-22, PRO XP '20-22

> ROCK SLIDERS



10-GAUGE STAMPED STEEL
NO LOSS IN GROUND CLEARANCE

LOW PROFILE

COLOR	2-SEAT	4-SEAT
■ MATTE BLACK	2883760-458	2883987-458
■ INDY RED	2883760-293	2883987-293

PRO XP '20-22
NOT COMPATIBLE WITH FRONT DOOR INNER CLOSEOFF PANELS (2884658)

PRO XP 4 '20-22
NOT COMPATIBLE WITH FRONT DOOR INNER CLOSEOFF PANELS (2884831) OR ALUMINUM DOORS (2884660-458)



4.5CM STEEL TUBE CONSTRUCTION
EXTENDS FROM MACHINE FOR MAX PROTECTION
THROUGH ROUGH TERRAIN

EXTREME KICK-OUT

COLOR	2-SEAT	4-SEAT
■ MATTE BLACK	2889208-458	2889209-458
■ INDY RED	2883997-293	2883988-293

PRO XP '20-22
NOT COMPATIBLE WITH FRONT DOOR INNER CLOSEOFF PANELS (2884658)

PRO XP 4 '20-22
NOT COMPATIBLE WITH FRONT DOOR INNER CLOSEOFF PANELS (2884831)

SEAMLESS INSTALLATION

Reusable anchors allow for easy installation of rock sliders into the built-in, dedicated chassis location.



CLOSED/
UNLOCKED

OPEN/
LOCKED

> LIGHTING



ACCENT LIGHT

- Durable construction resists dust and water while on the trails
- Front fascia LED accent light

» 2884346

PRO XP 4 '20-22, PRO XP '20-22
STANDARD ON PRO XP ULTIMATE AND PREMIUM



RIGID

ADVANCED TECH

RIGID lights are driven by Aluminum PCB Smart Boards™, 6063-T5 aircraft aluminum extruded housings and Tiger Drylac UV protection polyester powdercoating.

EXCLUSIVE OPTICS

RIGID invests heavily in optical science and has patented multiple optics and optics systems, maximizing light output and efficiency.

LIGHT BAR OPTIONS

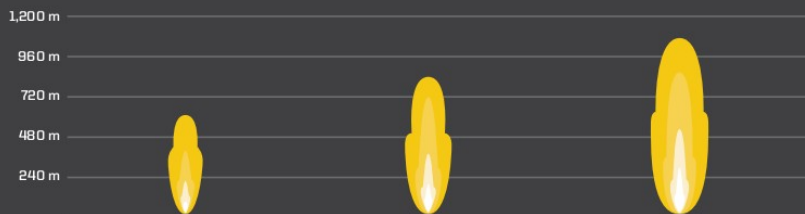

BRAND SIZE TYPE	RIGID 15.2 cm DUAL-ROW E-SERIES	RIGID 71.1 cm SR-SERIES	RIGID 81.3 cm SR-SERIES
RAW LUMENS	9,504	17,556	20,064
PN	2884649	2884074	2884648
FITMENT	PRO XP 4 '20-22, PRO XP '20-22	PRO XP 4 '20-22, PRO XP '20-22	PRO XP 4 '20-22, PRO XP '20-22

MOUNTS IN WINCH POCKET FOR SEAMLESS INTEGRATION IN FRONT BUMPERS

DESIGNED FOR USE WITH LIGHT POCKET ALUMINUM ROOF

MOUNTS TO ROOF FOR MAXIMUM VISIBILITY



RIGID CHASE LIGHT

- Bright, daylight visible lighting with eleven selectable modes, including white scene lighting for accessing cargo bed in the dark
- Connects into brake light system for additional high mount brake light

» 2884359

PRO XP 4 '20-22, PRO XP '20-22

1. CHOOSE YOUR LIGHT BAR

MOUNT OPTIONS

15.2 cm LIGHT BAR MOUNT

» 2884654

PRO XP 4 '20-22, PRO XP '20-22

71.1 cm LIGHT

MOUNT INCLUDED WITH LIGHT

81.3 cm LIGHT BAR MOUNT

» 2884650

PRO XP 4 '20-22, PRO XP '20-22

CHASE LIGHT MOUNT KIT

» 2884896

PRO XP 4 '20-22, PRO XP '20-22

2. ADD A MOUNT

HARNESS OPTIONS

MODEL	LIGHT BAR SET-UPS		CHASE LIGHT
	1 LIGHT IN 1 LOCATION ON 1 SWITCH	2 LIGHTS IN 2 LOCATIONS ON 2 SWITCHES	
PRO XP 4 '20-22 PRO XP '20-22	POLARIS PULSE LIGHT BAR HARNESS 2883949	POLARIS PULSE LIGHT BAR HARNESS (x2) 2883949	CHASE LIGHT HARNESS 2889034
	POLARIS PULSE HD LIGHT BAR HARNESS 2889130	POLARIS PULSE HD LIGHT BAR HARNESS (x2) 2889130	
	FOR LIGHTS THAT DRAW OVER 20A	FOR LIGHTS THAT DRAW OVER 20A	

3. ADD A HARNESS

POLARIS ENGINEERED ADVANTAGES



PLUG & PLAY ELECTRICAL

POLARIS PULSE IS A REVOLUTIONARY way to provide power to your vehicle and makes adding electrical accessories a snap.

SEE P. 56 FOR FULL LIGHTING OPTIONS

PRO XP



HAVE IT ALL

> STORAGE

ACCESSORY	PART NUMBER
28 L NORTHSTAR COOLER - GRAPHITE	2883424
LOCK & RIDE 28 L NORTHSTAR COOLER BRACKET	2884070
LOCK & RIDE 40L REAR CARGO BOX	2883752
PIVOTING SPARE TIRE CARRIER	2884907-458
7.25L DOOR STORAGE BAG	2884304
9.5L SHOULDER STORAGE BAG	2884286

LOCK & RIDE

70L FORWARD CARGO BOX TOP SELLER

- Protect your gear with lockable latches and side handles
- Durable polypropylene, engineered to seal out dust and water
- Lock & Ride strongly secures the box to the cargo bed

» 2883751
PRO XP 4 '20-'22, PRO XP '20-'22

FIT:
2 Full-Size Helmets
Tool Kit
Jacket/Coat
Food & Drinks



LOCK & RIDE

40L REAR CARGO BOX

- Protect your gear with lockable latches and side handles
- Durable polypropylene, engineered to seal out dust and water
- Lock & Ride strongly secures the box to the cargo bed

» 2883752
PRO XP 4 '20-'22, PRO XP '20-'22

FIT:
Sleeping Bag
First Aid Kit
Snacks
Sunscreen



FORWARD CARGO AND REAR CARGO STORAGE BOXES NEST PERFECTLY TOGETHER

REAR CARGO STORAGE BOX AND 28 L NORTHSTAR COOLER NEST PERFECTLY TOGETHER





LOCK & RIDE

72 L MULTI-PASSENGER REAR SEAT CARGO BOX

- Single wall base and dual wall lid that seal out dust and water
- Lock & Ride mounting for easy installation and removal
- Includes a drain plug and mounting hardware, with a location to add a padlock for increased security
- Only compatible with flip forward/fold flat storage in Premium/Ultimate models
- Fits full size off-road vehicle helmet

» 2884666
PRO XP 4 '20-22



PIVOTING SPARE TIRE CARRIER

- Secure mounting with dual latches
- Steel mounts and rack
- Holds up to a 32" tire and supports 34 kg of weight
- Single-handed release mechanism

» 2884907-458
PRO XP 4 '20-22, PRO XP '20-22

LOCK & RIDE

28 L REAR COOLER

- Lid locks securely in place with rubber latches to protect cargo
- Provides plenty of storage without weighing you down
- Keeps your food, beverages and bait fresh while out on the trails
- Nests with forward cargo box

» 2884623
PRO XP 4 '20-22, PRO XP '20-22



POLARIS NORTHSTAR 28 L COOLER

- Nests with rear cargo box

» GRAPHITE • 2883424
» DESERT • 2881315
PRO XP 4 '20-22, PRO XP '20-22



LOCK & RIDE

NORTHSTAR 28 L COOLER BRACKET

» 2884070
PRO XP 4 '20-22, PRO XP '20-22

SEE P. 80 FOR FULL DETAILS ON
POLARIS NORTHSTAR COOLERS



9.5L SHOULDER STORAGE BAG

- Keeps your belongings safe and secure
- Molded sides, lid inserts, waterproof zipper and a nylon mesh pocket for versatile storage options
- Easy install and quick access with a sleek cockpit look

» 2884286
PRO XP 4 '20-22, PRO XP '20-22
FITS BETWEEN REAR SEATS ONLY



FIT:
Flashlight
Snacks
Sunglasses
Bug Spray

7.25L DOOR STORAGE BAG

- Quick reach access to keep supplies and gear secure
- Waterproof zipper keeps everything enclosed, clean and dry
- Molded face with EVA carbon fiber vinyl cover design

» 2884304
PRO XP 4 '20-22, PRO XP '20-22
COMPATIBLE WITH FRONT DOORS ONLY
NOT COMPATIBLE WITH FRONT DOOR INNER
CLOSEOFF PANELS (2884658, 2884831)



FIT:
Cell Phone
Gloves
Sunscreen

SEE P. 97 FOR STRAPS AND COVERS

PRO XP



> MISC

ASSAULT GRILL

- Constructed from high quality aluminum for lasting quality
- Enhanced style with a sleek colored badge

■ INDY RED 2884646-293
■ BLUE METALLIC 2884646-751

PRO XP 4 '20-22, PRO XP '20-22

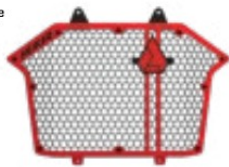

S&B PARTICLE SEPARATOR

- Separates over 94% of dust before it reaches the air filter
- Integrated hidden design in the fender to stay out of sight
- Variable fan based on engine speed to keep noise levels low

▶ 2884629
 PRO XP 4 '20-22, PRO XP '20-22
 ORDERABLE THROUGH
 LOCAL DEALER ONLY



SECONDARY BATTERY MOUNT KIT

- Provides longer lasting 12V output
- Battery sold separately

▶ 2884347
 PRO XP '20-22
 ▶ 2884391
 PRO XP 4 '20-22



> MIRRORS

ASSAULT BOMBER MIRRORS

- Billet aluminum construction to endure even the toughest trail conditions
- Colored accent bezels enhance the vehicle style

■ INDY RED 2884624-293
■ BLUE METALLIC 2884624-751

PRO XP 4 '20-22, PRO XP '20-22



ADJUSTABLE FOLDING SIDE MIRRORS

- Installs in minutes and integrates into a designated mounting position
- Laminated safety glass for excellent scratch resistance

▶ 2883762
 PRO XP 4 '20-22, PRO XP '20-22



PREMIUM CONVEX REARVIEW MIRROR

TOP SELLER

- Installs in minutes and integrates into a designated mounting position
- Laminated safety glass for excellent scratch resistance

▶ 2883763
 PRO XP 4 '20-22, PRO XP '20-22





PRO XP

AUDIO

WINDSHIELDS
& REAR PANELS

ROOFS, DOORS
& HEATER

VEHICLE PROTECTION
& LIGHTING

STORAGE

MISC. ACCESSORIES
& WINCHES

> WINCHES



FEATURES	PRO PRO HEAVY DUTY SERIES		REPLACEMENT PARTS
RAPID ROPE RECOVERY	STANDARD		
AUTO STOP TECHNOLOGY	STANDARD		
WINCH LINE	SYNTHETIC ROPE		
CONTROL	WIRELESS & WIRED STANDARD		
MODEL	2,721 kg	2,041 kg	
PRO XP 4 / PRO XP '20-22 Includes both wired and wireless remote	2883759	2883758	

SEE P. 84 FOR ADDITIONAL WINCH INFORMATION

PRO XP



ACCESSORIZE YOUR RZR
TO MAKE IT YOURS



PRO XP

AUDIO

WINDSHIELDS
& REAR PANELS

ROOFS, DOORS
& HEATER

VEHICLE PROTECTION
& LIGHTING

STORAGE

MISC. ACCESSORIES
& WINCHES

TURBO S & XP



TURBO S

LOWER DOOR INSERTS	P. 27
FRONT & REAR LOW PROFILE BUMPER	P. 28
RIGID SR-SERIES 81.3 cm COMBO LIGHT BAR + ACCENT LIGHTING	P. 56
PRO ARMOR WHEELS & TIRES	P. 62

XP TURBO

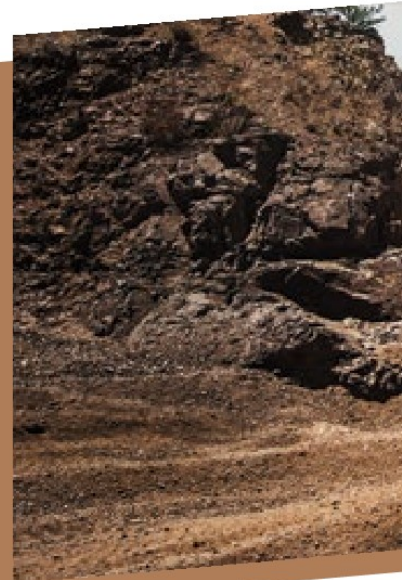

XP 1000

LOCK & RIDE HALF WINDSHIELD - HARD COAT POLY	P. 24
GRAPHIC SPORT ROOF	P. 26
FRONT & REAR BUMPERS	P. 28
LOW PROFILE ROCK SLIDERS	P. 28
MIRRORS	P. 31
TRAILBLAZER LED ADJUSTABLE HEADLIGHTS	P. 52
RIGID LIGHTING	P. 56

RS1



LOCK & RIDE FULL WINDSHIELD - HARD COAT POLY	P. 24
ALUMINUM ROOF	P. 26
REAR RACE NET	P. 25
FRONT & REAR BUMPERS	P. 28
FULL COVERAGE FENDER FLARES	P. 79
PRO ARMOR DUAL-ROW 76.2 cm COMBO LIGHT BAR	P. 56
POLARIS PRO HD 2,041 kg WINCH	P. 84
PRO ARMOR WHEELS & TIRES	P. 62



LOCK & RIDE FULL WINDSHIELD - HARD COAT POLY & REAR PANEL	P. 32
ALUMINUM ROOF	P. 32
FRONT LOW PROFILE SPORT BUMPER	P. 33
EXTREME DUTY BUMPER	P. 32
EXTREME KICK-OUT ROCK SLIDERS	P. 32
RZR SUBZERO 4 HARNESSES	P. 32
PRO ARMOR 50.8 cm DUAL-ROW COMBO LIGHT BAR	P. 56
IN-COCKPIT STORAGE	P. 33
POLARIS PRO HD 2,041 kg WINCH	P. 84
PRO ARMOR WHEELS & TIRES	P. 62

POLARIS RZR

MAKE IT YOURS

Whatever your style, however you ride, Polaris Engineered Accessories help you create your one-of-a-kind RZR.

ESSENTIALS TO KEEP YOU RIDING LONGER

- Windshields P. 24
- Rear Panels P. 25
- Roofs P. 26
- Doors P. 27
- Protection P. 28

ADD STYLE • ADD FUNCTION • ADD YOU

- Storage P. 30
- Mirrors P. 31
- Lighting P. 56
- Audio P. 60
- Wheels & Tires P. 62
- Winches P. 84

THE RIGHT STUFF TO MAINTAIN YOUR RZR

- Maintenance P. 88
- Oil & Lubricants P. 90

EVERYTHING YOU NEED TO GEAR UP

- Riding Gear P. 100
- Casualwear P. 104

TURBO S & XP



> WINDSHIELDS

HARD COAT POLY



LOCK & RIDE

FULL VENTED WINDSHIELD - HARD COAT POLY

- Impact-resistant, long-lasting .64 cm durable hard coated polycarbonate
- Full protection with airflow vents that quickly open for cockpit ventilation

» 2884330

XP TURBO '19-21, XP 4 TURBO '19-21, XP 4 1000 '19-22, XP 1000 '19-22



LOCK & RIDE

FULL WINDSHIELD - HARD COAT POLY TOP SELLER

- Durable, optical-grade polycarbonate provides maximum impact resistance

» 2884018

XP TURBO '19-21, XP 4 TURBO '19-21, XP 4 1000 '19-22, XP 1000 '19-22



LOCK & RIDE

HALF WINDSHIELD - HARD COAT POLY

- Impact-resistant, long-lasting .64 cm durable hard coated polycarbonate
- Provides protection and airflow into the cab

• 17.8 cm tall

» 2884768

TURBO S '19-21, XP TURBO '19-21, TURBO S 4 '19-21, XP 4 TURBO '19-21, XP 4 1000 '19-22, XP 1000 '19-22

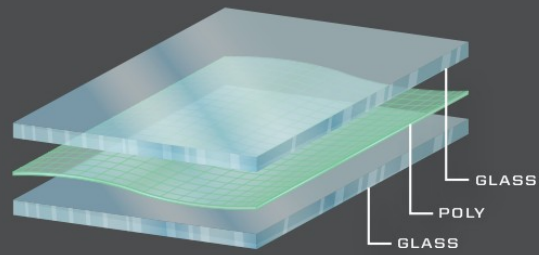
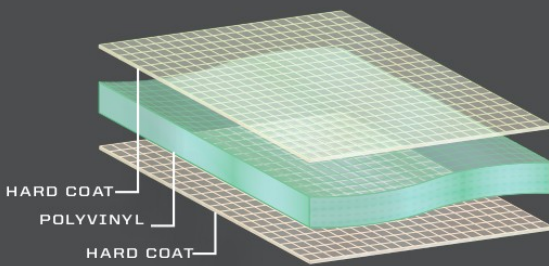

HARD COAT POLY VS GLASS

- Lightweight, flexible, easy to store/remove
- Impact-resistant
- 30x more scratch resistance than regular poly windshields

- Superior optical clarity (automotive level)
- Scratch-resistant
- Seals tight
- Cold weather/heavy duty

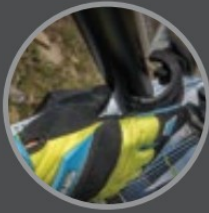

LOCK & RIDE

**REVOLUTIONARY
INSTALLATION**

Lock & Ride clamps make for easy on-off and eliminate the risk of cracking.



**GASKETED
SEAL**

Keeps drafts and moisture out. Reduces ride chatter on full glass windshields.

GLASS



**FULL WINDSHIELD -
GLASS**

- Double layer laminated, tempered glass windshield
- Fits seamlessly with the roof and hood of your vehicle to form a complete seal for maximum durability and reduced chatter

» 2884331

XP TURBO '19-21, XP 4 TURBO '19-21,
XP 4 1000 '19-22, XP 1000 '19-22



ADD A REAR PANEL TO
**REDUCE THE
DUST SWIRL**

> **REAR PANELS**

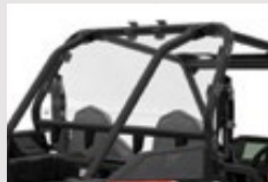

LOCK & RIDE

POLY REAR PANEL TOPSELLER

» 2881614
XP TURBO '15-21, XP 4 TURBO '15-21,
XP 4 1000 '14-22, XP 1000 '14-22
NOT COMPATIBLE WITH EXTREME
AUDIO PODS (2883739)



MESH REAR PANEL

» 2879507
XP TURBO '15-21, XP 4 TURBO '16-21,
XP 4 1000 '14-22, XP 1000 '14-22



REAR RACE NET

» 2879936
XP TURBO '15-21, XP 4 TURBO '16-21,
XP 4 1000 '14-22, XP 1000 '14-22

TURBO S & XP

> ROOFS

ALUMINUM VS POLY

- High protection strength
- Lower profile
- Sleek style

- Water run-off channels
- Quick on/off install
- Lightweight

POLY

LOCK & RIDE

POLY SPORT ROOF TOP SELLER

- Rigid, injection-molded design to eliminate warping in high-heat conditions
- Integrated mounting locations for lighting
- Rugged, textured polyethylene construction for impact and abrasion resistance
- Not compatible with upper or full doors

COLOR	2-SEAT	4-SEAT <small>NOT SHOWN</small>
■ MATTE BLACK	2883073	2883074
	XP TURBO '15-21, XP 1000 '14-22	XP 4 TURBO '15-21, XP 4 1000 '14-22

GRAPHIC SPORT ROOF

- Weighs only 5 kg (30% lighter than aluminum)
- Won't bend or break upon impact with debris or other obstacles
- Sunroof lets in sunlight while keeping you shaded from the heat

COLOR	2-SEAT	4-SEAT <small>NOT SHOWN</small>
■ MATTE BLACK	2881206	2881935
■ INDY RED	2881607	2881936
	XP TURBO '15-21, XP 1000 '14-22	XP 4 TURBO '15-21, XP 4 1000 '14-22
	COMES STOCK ON TURBO S AND TURBO S 4 DYNAMIX	

ALUMINUM

ALUMINUM ROOF TOP SELLER

- Seals to the vehicle frame for the best protection and great integration with other RZR accessories
- Strong and durable 5051 aluminum construction for long-lasting, reliable protection

COLOR	2-SEAT	4-SEAT <small>NOT SHOWN</small>
■ MATTE BLACK	2881582-458	2881592-458
■ INDY RED	2881582-293	2881592-293
	XP TURBO '15-21, XP 1000 '14-22	XP 4 TURBO '15-21, XP 4 1000 '14-22

COLOR	2-SEAT	4-SEAT
■ MATTE BLACK	2884086-458	2884087-458
	TURBO S '18-21	TURBO S 4 '19-21
	COMES STOCK ON TURBO S AND TURBO S 4 DYNAMIX	





> DOORS

ALUMINUM DOORS

- Single-piece stamped aluminum maximizes quality, fit and finish
- More cockpit room with wide berth
- Gasket design eliminates rattling and creates a firm seal
- Graphics not included

2-SEAT • 2879510 NOT SHOWN

TURBO S '18-21, XP TURBO '15-21, XP 1000 '14-22

4-SEAT • 2879943

TURBO S 4 '19-21, XP 4 TURBO '16-21, XP 4 1000 '14-22

LOWER DOOR INSERTS TOP SELLER

- Covers the bottom of the door opening, shutting out water and dust
- Durable plastic construction with steel frame

2-SEAT • 2879509 NOT SHOWN

TURBO S '18-21, XP TURBO '15-21, XP 1000 '14-22

4-SEAT • 2879942

TURBO S 4 '19-21, XP 4 TURBO '16-21, XP 4 1000 '14-22

CANVAS UPPER DOORS

- Easy install with stock door panels using pre-designated mounting points
- 23 OZ mold-resistant, UV-stable and crack-resistant materials for lasting durability and protection
- Install with roof, full windshield, rear panel and lower doors to create a full cab enclosure for colder weather and/or increased protection
- Not compatible with Poly Sport Roof or Audio Roof options

2-SEAT • 2884333

XP TURBO '19-21, XP 1000 '19-22

4-SEAT • 2884332 NOT SHOWN

XP 4 TURBO '19-21, XP 4 1000 '19-22

TURBO S & XP

WINDSHIELDS
& REAR PANELS

ROOFS & DOORS

VEHICLE PROTECTION
& WINCHES

STORAGE
& MIRRORS

RZR RSL ACCESSORIES

TURBO S & XP



> BUMPERS & ROCK SLIDERS

LOW PROFILE BUMPER TOP SELLER

- Perfect for heavy-duty protection, with an aggressive style and mounting for lights



FRONT



4.4 cm DIAMETER STEEL TUBE CONSTRUCTION



REAR

COLOR	FRONT	REAR
MATTE BLACK	2884019-458	2884020-458
INDY RED	2884019-293	2884020-293
TITANIUM	2884019-632	2884020-632
SKY BLUE	2884019-737	2884020-737

XP TURBO '15-21, XP 4 TURBO '16-21, XP 4 1000 '14-22, XP 1000 '14-22

COLOR	FRONT	REAR
MATTE BLACK	2883132-458	2883133-458

TURBO S '18-21, TURBO S 4 '19-21

LOW PROFILE ROCK SLIDERS

- Plated steel construction, durable powdercoat finish
- Easy installation with expanded anchor mount



2-SEAT

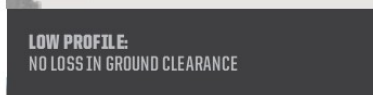

4-SEAT

COLOR	2-SEAT	4-SEAT
MATTE BLACK	2879498-458	2879940-458
INDY RED	2881587-293	2881593-293
SKY BLUE	2881587-737	2881593-737

2-SEAT: TURBO S '18-21, XP TURBO '15-21, XP 1000 '14-22

4-SEAT: TURBO S 4 '19-21, XP 4 TURBO '16-21, XP 4 1000 '14-22

EXTREME KICK-OUT ROCK SLIDERS

- Rugged steel protection and race-inspired styling
- Low-profile mounting location will not diminish ground clearance



2-SEAT

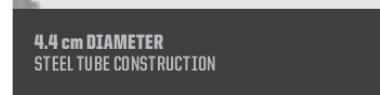

4-SEAT

COLOR	2-SEAT	4-SEAT
MATTE BLACK	2879456-458	2882079-458
INDY RED	2881586-293	2882079-293
SKY BLUE	2881586-737	2882079-737

2-SEAT: TURBO S '18-21, XP TURBO '15-21, XP 1000 '14-22

4-SEAT: TURBO S 4 '19-21, XP 4 TURBO '16-21, XP 4 1000 '14-22

ANCHOR MOUNTS

Tougher than conventional nuts and bolts, Expansion Anchor Mounts are engineered into every RZR, allowing for a fast install.

BUMPER ANCHOR PACK

- Four anchors and two bumper end caps included
- 2205114

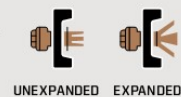

UNEXPANDED EXPANDED



TURBO S & XP

WINDSHIELDS
& REAR PANELS

ROOFS & DOORS

VEHICLE PROTECTION
& WINCHES

STORAGE
& MIRRORS

RZR RSL ACCESSORIES

> WINCHES



FEATURES	PRO PRO HEAVY DUTY SERIES	HD HEAVY DUTY SERIES	
RAPID ROPE RECOVERY	STANDARD	NOT AVAILABLE	
AUTO STOP TECHNOLOGY	STANDARD	OPTION	
WINCH LINE	SYNTHETIC ROPE	STEEL CABLE	
CONTROL	WIRELESS STANDARD, WIRED OPTION	WIRED STANDARD, WIRELESS OPTION	
MODEL	2,041 kg	1,588 kg	ADD REQUIRED CABLES
XP 4 1000 '14-22 XP 4 TURBO '16-21 XP 1000 '14-22 XP TURBO '15-21	TOP SELLER 2882240	TOP SELLER 2881671	XP 4 1000 / XP 1000 '19-22, XP 4 TURBO / XP TURBO '19-21 REQUIRE WINCH COVER KIT 2884118
TURBO S '18-21 TURBO S 4 '19-21	2883828		INCLUDED WITH WINCH
RSL '18-22	2883825 EXTREME BUMPER (2883783-458) REQUIRED, SOLD SEPARATELY		INCLUDED WITH WINCH

See P. 57 for Bus Bar Harness fitment

REPLACEMENT PARTS

SYNTHETIC ROPE

2,041 kg SERIES
 » 2879187



STEEL CABLE

1,588 kg SERIES
 » 2878890



UPGRADE YOUR CONTROLS

WIRED REMOTE CONTROL

• Must order remote handle and socket together

» REMOTE HANDLE 4013466 » SOCKET 4017102 » SOCKET 4014228
 WORKS WITH 2882240, 2883825 WORKS WITH 2883825 WORKS WITH 2882240, 2883828

UPGRADE YOUR HD WINCH

WIRELESS REMOTE

• Up to 15 m range with LED indicator
 • Direct plug & play operation
 » 2879316



AUTO STOP UPGRADE

• Billeted aluminum
 • Replaces stock fairlead
 » 2881693
 SYNTHETIC ROPE REQUIRED

TURBO S & XP

> STORAGE



LOCK & RIDE 45 L COOLER BOX

- One-piece rotomolded construction for extreme durability
- Lid locks securely in place with rubber latches to protect cargo
- Heavy-duty hinges and weatherproof seal block moisture and dust
- Keeps food and beverages cool for 48+ hours, depending on conditions
- UV-fade resistant
- Installs quickly and easily without tools
- Easy to carry with integrated grab handles

» 45.4 L2881555

TURBO S '18-21, XP TURBO '15-21, TURBO S 4 '19-21, XP 4 TURBO '16-21, XP 4 1000 '14-22, XP 1000 '14-22

LOCK & RIDE D-RINGS

» 2881544

LOCK & RIDE EXPANSION ANCHOR

» 2876420

BED D-RINGS

» 2877460

TURBO S '18-21, XP TURBO '15-21, TURBO S 4 '19-21, XP 4 TURBO '16-21, XP 4 1000 '14-22, XP 1000 '14-22



LOCK & RIDE 65 L CARGO BOX TOP SELLER

- Secure latching lid with taut rubber strap tie-downs
- Lightweight design integrates seamlessly into the rear cargo bed
- Includes all mounting hardware for complete installation

» 2881193

TURBO S '18-21, XP TURBO '15-21, TURBO S 4 '19-21, XP 4 TURBO '16-21, XP 4 1000 '14-22, XP 1000 '14-22



SPARE TIRE CARRIER

- Easily carry a spare tire without sacrificing valuable cargo box capacity
- Mounts to the rear cab frame extension in less than five minutes using four fasteners and an integrated, built-in lug wrench
- Remove two of the quick-release pins to pivot the carrier and gain access to the cargo box

» 2883487

TURBO S '18-21, TURBO S 4 '19-21

» 2879464

XP TURBO '15-21, XP 4 TURBO '16-21, XP 1000 '14-22, XP 4 1000 '14-22



LOWER DOOR STORAGE BAG

» 2880613

TURBO S '18-21, XP TURBO '16-21, TURBO S 4 '19-21, XP 4 TURBO '16-21, XP 4 1000 '14-22, XP 1000 '14-22
REQUIRES LOWER DOOR INSERTS (2879509, 2879942)
ONLY COMPATIBLE WITH FRONT DOORS

> MIRRORS



ADJUSTABLE FOLDING SIDE MIRRORS

- Left and right mirrors included
- Installs in minutes and integrates into a designed mounting position
- Laminated safety glass for excellent scratch resistance

» 2884524

TRAIL S '21-22, TRAIL '21-22, TURBO S '18-21, XP TURBO '19-21, XP 1000 '14-22, TURBO S 4 '20-21, XP 4 TURBO '19-21, XP 4 1000 '14-22, S 900 '15-20, S 4 1000 '19-20, S 1000 '16-20, 900 '14-20



CONVEX DESIGN DELIVERS
WIDE REAR VIEW

REARVIEW MIRROR TOP SELLER

- Works with all roofs, soft tops and windshields

» 2877945

TURBO S '18-21, XP TURBO '15-21, TURBO S 4 '19-21, XP 4 TURBO '16-21, XP 4 1000 '14-22, XP 1000 '14-22



SCRATCH-RESISTANT
GLASS MIRROR LENS

CONVEX REARVIEW MIRROR TOP SELLER

- Bolts into your choice of pre-designated mounting locations on the vehicle frame for easy install
- Convex design provides broad, expanded view of what's behind or alongside the vehicle

» 2881540

TURBO S '18-21, XP TURBO '15-21, TURBO S 4 '19-21, XP 4 TURBO '16-21, XP 4 1000 '14-22, XP 1000 '14-22



QUICK GLANCE,
WIDE-ANGLE VIEWING FOR
MAXIMUM VISIBILITY

WIDE-ANGLE REARVIEW MIRROR

- Stamped steel frame and backing plate with large 6.4 cm x 35.6 cm convex mirror
- Up to 10° of range to adjust for rider height or view preference
- Easy over-structure installation with stamped steel mounts

» 2881199

TURBO S '18-21, XP TURBO '15-21, TURBO S 4 '19-21, XP 4 TURBO '16-21, XP 4 1000 '14-22, XP 1000 '14-22

TURBO S & XP

POLARIS RZR R51

ALUMINUM ROOF

- Strong, durable 5051 aluminum construction
- 360-degree sealed to eliminate vibration

» 2882698-458 • BLACK
RS1 18-22

RZR SUBZERO 4-PT HARNESS

- Exclusive, controlled deceleration technology
- Better vehicle control, less ride fatigue and reduced submarining
- CAPE and Polaris validated

» 2882709
RS1 18-22

EXTREME DUTY BUMPER

- Front bumper required for winch installation
- Easy installation into factory mounts
- Fully e-coated and powder-coated for premium protection
- Includes all mounting hardware

» FRONT • 2883783-458 • BLACK
» REAR • 2882694-458 • BLACK
RS1 18-22

SPORT SIDE TIRE CARRIER

- Mounts directly to Extreme Kick-Out Rock Sliders (2882695-458)

» 2882738
RS1 18-22

EXTREME KICK-OUT ROCK SLIDERS

- Fully e-coated and powder-coated for premium protection
- Stock ground clearance is maintained
- Required for the Sport Side Tire Carrier (2882738)

» 2882695-458 • BLACK
RS1 18-22

SEE P. 56
FOR LIGHTING
& HARNESES

LOCK & RIDE

FULL WINDSHIELD - HARD COAT POLY

- Frameless design fully seals around cab frame
- Premium, optical-grade impact-resistant poly material

» 2882703
RS1 18-22

LOCK & RIDE

HALF WINDSHIELD - POLY NOT SHOWN

» 2882704
RS1 18-22



SEE P. 76 FOR
PRO ARMOR
WHEEL & TIRE SETS

POLARIS PRO HD 2,041 KG WINCH

» 2883825
RS1 18-22

See P. 84 for full winch details

POLARIS ENGINEERED ADVANTAGES



PLUG & PLAY ELECTRICAL

EFFORTLESSLY ADD LIGHTS

POLARIS PULSE LIGHT BAR HARNESS
2883388

SEE P. 56 FOR
MORE INFORMATION

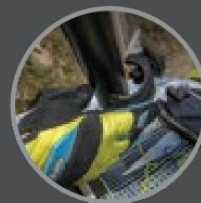

LOCK & RIDE

REVOLUTIONARY INSTALLATION

Lock & Ride clamps make for easy on-off and eliminate the risk of cracking.



49L
1 Helmet
2 Goggles/Gloves
12 Beverage Cans

LOCK & RIDE

**49L REAR COOLER/
STORAGE COMBO**

- Seamless mounting to the rear cargo platform

» 2882701
RS1 '18-22



13L
10 Beverage Cans

**13L UNDERHOOD COOLER/
STORAGE COMBO**

- Fits in the underhood compartment
- Removable, waterproof cooler liner for easy cleaning

» 2882700
RS1 '18-22



10L
1 Goggles
2 Cell Phones
3 Small Items

QUIKREACH 10L DOORPAK

- Three storage compartments
- "Quick to Reach" and mounted directly to driver-side door

» 2882697
RS1 '18-22



8L
2 Cell Phones
2 Gloves
1 Small Item

QUIKREACH 8L DASHPAKS

- "Quick to Reach" storage on both sides of steering wheel

» 2883332
RS1 '18-22



**FRONT LOW PROFILE
SPORT BUMPER**

- Tough, tubular steel design
- Easy installation into factory mounts
- Fully e-coated and powder-coated for premium protection
- Includes all mounting hardware

» 2882692-458
RS1 '18-22



**BLUETOOTH INTEGRATED 200
WATT AUDIO SYSTEM BY MB
QUART**

- 5.1 cm x 13.3 cm speakers and 1.9 cm titanium dome tweeters with dash enclosures
- Fully-integrated Bluetooth audio system
- Bluetooth remote fits seamlessly into switch panel
- Includes all necessary wiring, harnesses and mounting hardware

» 2882696
RS1 '18-22



FULL COVERAGE FENDER FLARES

- Extra-wide design protects you and your vehicle from kicked-up debris
- Easily and seamlessly attaches to existing plastic
- Front and rear included

» 2883488
RS1 '18-22



LOCK & RIDE

POLY REAR PANEL

» 2882706
RS1 '18-22

TRAILERABLE COVER (NOT SHOWN)

- Strong, durable, weatherproof canvas construction
- UV-stable to resist fading from prolonged exposure to sunlight

» 2882705
RS1 '18-22



**ADD A REAR PANEL TO REDUCE
THE DUST SWIRL**

With a windshield and roof installed, turbulent air develops behind the cab. Add a rear panel to reduce dust intrusion from this swirl.

TRAIL

POLARIS
RZR TRAIL



TRAIL AGILITY.
ENDLESS COMFORT.



> COMFORT

All the essentials to customize your cab for comfortable riding in any element.

Windshields P. 39
Roofs P. 40
Doors P. 40
Heater Kit P. 44



> PREMIUM TECHNOLOGY

Take on the trails with unrivaled tech components, ranging from functional to fun.

Rockford Fosgate Audio P. 41
Polaris PULSE P. 46
Lighting P. 46
RIDE COMMAND P. 58



PLUG & PLAY ELECTRICAL

EFFORTLESSLY ADD LIGHTS, AUDIO & WINCH



> ULTIMATE DURABILITY

Cover your bases with ease and protection, giving you confidence to stay riding longer.

Protection P. 42
Storage P. 43
Wheels & Tires P. 62

TRAIL

> COLLECTIONS



Feel confident to take on the trails with all the **essentials** you need.

2889537	TIP OUT WINDSHIELD - HARD COAT POLY	P. 39
2884729	LOCK & RIDE POLY SPORT ROOF	P. 40
2884732-458	FRONT HIGH COVERAGE BUMPER	P. 42
2880164-458	REAR DELUXE BUMPER (EU MODELS)	P. 42
2883763	PREMIUM CONVEX REARVIEW MIRROR	P. 83
2884524	FOLDING SIDE MIRRORS	P. 83
2884912	STAGE 1 PMX AUDIO KIT BY ROCKFORD FOSGATE	P. 41
2883945	REAR SPEAKER PODS BY ROCKFORD FOSGATE	P. 41
2415652	REAR SPEAKER POD AUDIO HARNESS	P. 41
2884871	FANG ACCENT LIGHTS*	P. 53
2883123	RIGID SR-SERIES 10" COMBO LED LIGHT	P. 57
2884657	LIGHT BAR HARNESS	P. 57
2883216	PRO ARMOR WHEEL & TIRE SET: 4301 BEADLOCK & DUAL THREAT, 26"***	P. 76

Shown on Trail.
*Fang accent lights come stock on Premium and Ultimate trims (US models).
**May widen vehicle beyond 50".

Lead the charge with ultimate **protection** to enjoy the turns of the trails.

2884911	LOCK & RIDE FULL VENTED WINDSHIELD - HARD COAT POLY	P. 39
2884765	LOCK & RIDE POLY REAR PANEL	P. 39
2884761-458	ALUMINUM ROOF	P. 40
2884868-458	FRONT WINCH BUMPER	P. 42
2880164-458	REAR DELUXE BUMPER (EU MODELS)	P. 42
2879456-458	EXTREME KICK-OUT ROCK SLIDERS	P. 42
2881985	FULL COVERAGE FENDER FLARES	P. 79
2883763	PREMIUM CONVEX REARVIEW MIRROR	P. 83
2884524	FOLDING SIDE MIRRORS	P. 83
2881193	LOCK & RIDE 65 L CARGO BOX	P. 43
2885126	POLARIS PRO HD 4,500 LB WINCH WITH RAPID ROPE RECOVERY	P. 44
2883157	PRO ARMOR WHEEL & TIRE SET: 5202 & ATTACK 2.0, 28"	P. 76
2879332	12MM x 1.5 SPLINED LUG NUTS WITH WRENCH ADAPTER	P. 74

Shown on Trail S.



TRAILBLAZER

ADVENTURER

TRAIL ACCESSORIES

WINDSHIELDS
& REAR PANELS

ROOF'S, DOORS
& AUDIO

VEHICLE PROTECTION
& STORAGE

WINDSHIELD HEATER
& PLOWES

LIGHTING & ELECTRICAL
& TRACKS

ACCESSORIES

2014-2020 TRAIL

All-day riding made easy, with added **comfort** and maximum visibility.

2884756	FULL VENTED WINDSHIELD - GLASS	P. 39
2884755	WINDSHIELD WIPER - WASHER KIT	P. 39
2884765	LOCK & RIDE POLY REAR PANEL	P. 39
2884729	LOCK & RIDE POLY SPORT ROOF	P. 40
2884733	CANVAS UPPER DOORS, 60"	P. 40
2884019-293	FRONT LOW PROFILE BUMPER	P. 42
2881587-293	LOW PROFILE ROCK SLIDERS	P. 42
2883763	PREMIUM CONVEX REARVIEW MIRROR	P. 83
2884735	HEATER KIT	P. 44
2884917	FACTORY AUDIO STAGE 3 UPGRADE BY ROCKFORD FOSGATE	P. 41
2884648	RIGID SR-SERIES 81 CM COMBO LED LIGHT BAR	P. 46
2884650	81 CM LIGHT BAR MOUNT	P. 46
2884657	LIGHT BAR HARNESS	P. 46
2884183	POLARIS PULSE UNDERHOOD BUS BAR - 6 POSITION	P. 46
2881556	LOCK & RIDE 48 L COOLER BOX	P. 43
2885126	POLARIS PRO HD 4,500 LB WINCH WITH RAPID ROPE RECOVERY	P. 44
2883182	PRO ARMOR WHEEL & TIRE SET: 5203 BEADLOCK & CRAWLER XG, 28"	P. 76
1522240	15" FORGED BEADLOCK RING	P. 75
2879332	12MM x 1.5 SPLINED LUG NUTS WITH WRENCH ADAPTER	P. 74

Shown on Trail S.

TRAIL



> BUILD YOUR CAB

ADD COMFORT AND STYLE WITH END-TO-END PROTECTION

ADD A WINDSHIELD
Protect yourself and your passenger with optical clarity.

ADD A ROOF
Shield from harsh elements while adding style.

ADD A REAR PANEL
Maintain rear visibility while reducing rear air swirl.



ADD DOORS
Keep the cab free of debris and water.

RECOMMENDED BUILD 1

2889537	TIP OUT WINDSHIELD - HARD COAT POLY
2884765	LOCK & RIDE POLY REAR PANEL
2884761-458	ALUMINUM ROOF
2884733	CANVAS UPPER DOORS, 60" *

RECOMMENDED BUILD 2

2884756	FULL VENTED WINDSHIELD - GLASS
2884755	WINDSHIELD WIPER - WASHER KIT
2884765	LOCK & RIDE POLY REAR PANEL
2884729	LOCK & RIDE POLY SPORT ROOF
2884733	CANVAS UPPER DOORS, 60" *

*Trail models should use Canvas Upper Doors, 50" (2884758)



LOCK & RIDE
REVOLUTIONARY INSTALLATION

Lock & Ride clamps make for easy on-off and eliminate the risk of cracking.



GASKETED SEAL

Keeps drafts and moisture out. Reduces ride chatter on full glass windshields.

WINDSHIELDS

GLASS



WIPER READY

FULL VENTED WINDSHIELD - GLASS

- Double layer laminated, tempered glass windshield with steel powder-coated frame and center adjustable vent

» 2884756

TRAIL S '21-22, TRAIL '21-22

HARD COAT POLY



LOCK & RIDE

FULL VENTED WINDSHIELD - HARD COAT POLY

- Impact-resistant, long-lasting .64 cm durable hard coated polycarbonate
- Full protection with airflow vents that quickly open for cockpit ventilation

» 2884911

TRAIL S '21-22, TRAIL '21-22



TIP OUT WINDSHIELD - HARD COAT POLY

- Hard coated polycarbonate panel windshield that offers three positions: closed, vented and full open

» 2889537

TRAIL S '21-22, TRAIL '21-22



WINDSHIELD WIPER - WASHER KIT

- Simple to control, featuring a multi-speed dash-mounted rocker switch
- Includes a washer fluid reservoir

» 2884755

TRAIL S '21-22, TRAIL '21-22
COMPATIBLE WITH GLASS WINDSHIELD ONLY



LOCK & RIDE

FULL WINDSHIELD - HARD COAT POLY

- Impact-resistant, long-lasting .64 cm durable hard coated polycarbonate
- No frame design offers maximum visibility
- Integrates with all cab components

» 2884757

TRAIL S '21-22, TRAIL '21-22



LOCK & RIDE

HALF WINDSHIELD - HARD COAT POLY

- Impact-resistant, long-lasting .64 cm durable hard coated polycarbonate
- Provides protection and airflow into the cab
- 17.8 cm tall

» 2884768

TRAIL S '21-22, TRAIL '21-22

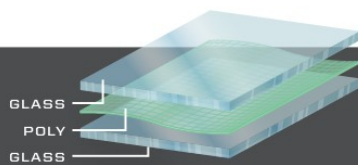

GLASS
POLY
GLASS

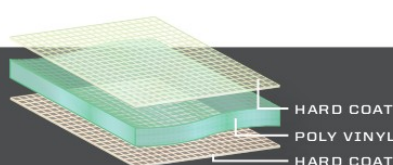

HARD COAT
POLY VINYL
HARD COAT

GLASS VS HARD COAT POLY

- Superior optical clarity (automotive level)
- Scratch-resistant
- Seals tight
- Cold weather/heavy duty

- Lightweight, flexible, easy to store/remove
- Impact-resistant
- 30x more scratch resistance than regular poly windshields

REAR PANEL



LOCK & RIDE

POLY REAR PANEL

- Maintains rear visibility and reduces rear air swirl from entering the cockpit
- Fully compatible with all accessories
- If installed, Rear Audio Pods should project backwards

» 2884765

TRAIL S '21-22, TRAIL '21-22

TRAIL



> ROOFS

ALUMINUM VS POLY

- High protection strength
- Lower profile
- Sleek style

- Water run-off channels
- Quick install
- Lightweight

ALUMINUM

ALUMINUM ROOF

- Seals to the roll cage for the best protection, while seamlessly integrating with other RZR accessories
- Strong and durable aluminum construction for long-lasting, reliable protection

COLOR	PART NUMBER
■ MATTE BLACK	2884761-458
■ INDY RED	2884761-293

TRAIL S '21-'22, TRAIL '21-'22



POLY

LOCK & RIDE POLY SPORT ROOF

- Rigid, injection-molded design to eliminate warping in high-heat conditions
- Integrated mounting locations for lighting
- Rugged, textured polyethylene construction for impact and abrasion resistance

COLOR	PART NUMBER
■ MATTE BLACK	2884729

TRAIL S '21-'22, TRAIL '21-'22
STANDARD ON ULTIMATE TRIM

> DOORS



CANVAS UPPER DOORS

- Pre-loaded tubular aluminum frame provides a tight seal along the roll cage
- Zip-down vinyl windows offer increased comfort in warmer conditions
- Zippered access ports for easy ingress and egress

- » 60" • 2884733
TRAIL S '21-'22
- » 50" • 2884758 NOT SHOWN
TRAIL '21-'22

ALUMINUM LOWER HALF DOORS

- Single-piece stamped aluminum maximizes quality, fit and finish
- Gasket design eliminates rattling and creates a firm seal

- » 2879510
TRAIL S '21-'22

A NEW AUDIO EXPERIENCE



Rockford Fosgate partnered with Polaris to create the next evolution of factory-installed off-road audio. Purpose built to stand up to any outdoor environment and designed to perform no matter the ride. Specifically tuned and rider-centric to create a class-leading audio experience that is second to none.

> AUDIO

BUILD YOUR SOUND (CHOOSE THE PATH THAT MATCHES YOUR RZR)

NO FACTORY AUDIO

STEP 1

SELECT HEAD UNIT & ADD AUDIO

7" DISPLAY POWERED BY RIDE COMMAND

2884072
TRAIL S '22

MOUNT KIT REQUIRED

2884731
TRAIL S '22

SEE P. 58 FOR FULL RIDE COMMAND DETAILS



STAGE 3 RIDE COMMAND AUDIO KIT

2884914
TRAIL S '22

OR

STAGE 1 PMX AUDIO KIT

2884912
TRAIL S '21-22, TRAIL '21-22

MOUNT KIT INCLUDED

STEP 2

UPGRADE AUDIO

REAR SPEAKER PODS

2883945
TRAIL S '21-22, TRAIL '21-22

REAR SPEAKER POD AUDIO HARNESS

2415652
TRAIL S '21-22, TRAIL '21-22
REQUIRED TO ADD PODS TO STAGE 1 OR STAGE 3



7" DISPLAY POWERED BY RIDE COMMAND

» 2884072
TRAIL S '22
REQUIRES MOUNT KIT (2884731)

SEE P. 58 FOR FULL RIDE COMMAND DETAILS



STAGE 1 PMX AUDIO KIT

- 6.86 cm full color display
- AM/FM/WB tuner w/ antenna*
- Bluetooth connectivity
- Includes mount kit
- Two front 16.5 cm coaxial speakers with enclosures

» 2884912
TRAIL S '21-22, TRAIL '21-22
NOT COMPATIBLE WITH ULTIMATE TRIM



STAGE 3 RIDE COMMAND AUDIO KIT FRONT SPEAKERS & SUBWOOFER

- **200 watt** 25.4 cm subwoofer with enclosure
- **400 watt** full range amplifier
- **Two 50 watt** 16.51 cm component speakers with enclosures

» 2884914
TRAIL S '22
NOT COMPATIBLE WITH ULTIMATE TRIM OR STAGE 1 PMX AUDIO KIT



REAR SPEAKER PODS USE WITH STAGE 1 OR STAGE 3

- **50 watt** 16.51 cm coaxial speakers with can-enclosures, mounting hardware and grilles
- Audio Harness (2415652) required, sold separately

» 2883945
TRAIL S '21-22, TRAIL '21-22

* The FM Frequency range is from 88 to 108 and only on the odds (i.e. 88.1, 88.3, etc.).

TRAIL

> BUMPERS / FENDER FLARES



FRONT HIGH COVERAGE BUMPER

- Durable, powder-coated 4.45 cm tube steel with sleek profile for full coverage with headlight protection
- Does not cover Fang Accent Lights

COLOR	PART NUMBER
■ MATTE BLACK	2884732-458
■ INDY RED	2884732-293

TRAIL S '21-22, TRAIL '21-22



FRONT LOW PROFILE BUMPER

- 4.45 cm powder-coated steel tubing provides impact protection and aggressive styling

COLOR	PART NUMBER
■ MATTE BLACK	2884019-458
■ INDY RED	2884019-293

TRAIL S '21-22, TRAIL '21-22



FRONT WINCH BUMPER

- Elevated mounting location on bumper for easy access to 2,041 kg winch

COLOR	PART NUMBER
■ MATTE BLACK	2884868-458

TRAIL S '21-22, TRAIL '21-22



REAR BUMPER EXTENSION

- Bumper extension quickly attaches to rear ROPS to provide additional taillight protection

COLOR	PART NUMBER
■ MATTE BLACK	2884734-458

TRAIL S '21-22, TRAIL '21-22 (US MODEL ONLY)



REAR DELUXE BUMPER

- Rear bumper extension expressly developed for EU-Models

COLOR	PART NUMBER
■ MATTE BLACK	2880164-458

TRAIL S '21-22 EU MODEL

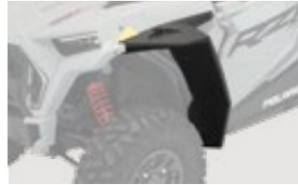

FULL COVERAGE FENDER FLARES

- Keep the mud, dirt and debris from launching off the tires and into your face
- Includes two, front only

» 2881985

TRAIL S '21-22, TRAIL '21-22

> ROCK SLIDERS



10-GAUGE STAMPED STEEL
NO LOSS IN GROUND CLEARANCE

LOW PROFILE

COLOR	PART NUMBER
■ MATTE BLACK	2879488-458
■ INDY RED	2881587-293

TRAIL S '21-22, TRAIL '21-22



4.5cm STEEL TUBE CONSTRUCTION
EXTENDS FROM MACHINE FOR MAX
PROTECTION THROUGH ROUGH TERRAIN

EXTREME KICK-OUT

COLOR	PART NUMBER
■ MATTE BLACK	2879456-458
■ INDY RED	2881586-293

TRAIL S '21-22, TRAIL '21-22

ANCHOR MOUNTS

Tougher than conventional nuts and bolts, Expansion Anchor Mounts are engineered into every RZR, allowing for a fast install.

BUMPER ANCHOR PACK

- Four anchors and two bumper end caps included

» 2205114



UNEXPANDED



EXPANDED



> STORAGE

TRAIL ACCESSORIES

WINDSHIELDS
& REAR PANELS

ROOF DOORS
& AUDIO

VEHICLE PROTECTION
& STORAGE

WINDRES HEATER
& PLOWES

LIGHTING & ELECTRICAL
& TRACKS

ACCESSORIZE IT

2014-2020 TRAIL



LOCK & RIDE

48 L COOLER BOX

- One-piece, rotomolded construction for extreme durability
- Lid locks securely in place with rubber latches to protect cargo
- Heavy-duty hinges and weatherproof seal block moisture and dust
- Keeps food and beverages cool for 48+ hours, depending on conditions
- UV-fade resistant
- Installs quickly and easily without tools
- Easy to carry with integrated grab handles

» 2881556
TRAIL S '21-22, TRAIL '21-22

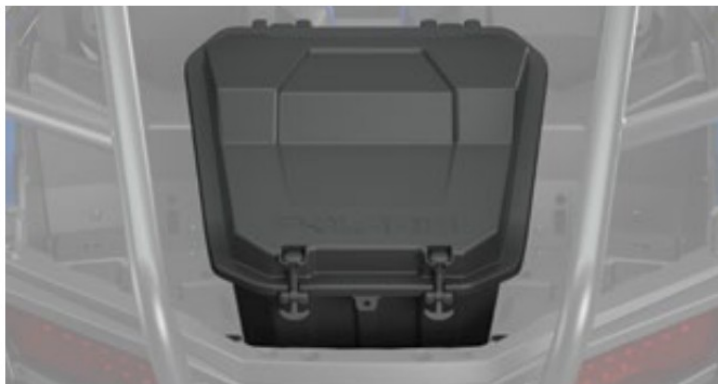

LOCK & RIDE

65 L CARGO BOX

TOP SELLER

- Integrated rear cargo box, touting 65 L of storage
- Secure latching lid with taut rubber strap tie-downs
- Lightweight design integrates seamlessly into the rear cargo bed
- Includes all mounting hardware for complete installation

» 2881193
TRAIL S '21-22, TRAIL '21-22



SPARE TIRE CARRIER

- Mounts to rear ROPS to keep cargo bed free
- Compatible with Rear Bumper Extension (2884734-458)
- Quick installation

» 2884762
TRAIL S '21-22, TRAIL '21-22
(US MODEL ONLY)

BED D-RINGS

» 2877460
TRAIL S '21-22, TRAIL '21-22

LOCK & RIDE D-RINGS

» 2881544
TRAIL S '21-22, TRAIL '21-22



SEE P. 83 FOR MIRRORS

TRAIL



> WINCHES

FEATURES	PRO PRO HEAVY DUTY SERIES	HD HEAVY DUTY SERIES	
RAPID ROPE RECOVERY	STANDARD	NOT AVAILABLE	
AUTO STOP TECHNOLOGY	STANDARD	OPTION	
WINCH LINE	SYNTHETIC ROPE	STEEL CABLE	
CONTROL	WIRELESS & WIRED STANDARD	WIRED STANDARD, WIRELESS OPTION	
MODEL	2,041 kg	1,588 kg	ADD REQUIRED CABLES
TRAIL S '21-'22 TRAIL '21-'22	2885126 	2885127 	SEE P. 57 FOR BUS BAR HARNESS FITMENT WINCH COVER KIT REQUIRED 2884118 <small>TRAIL S '21-'22, TRAIL '21-'22</small>

REPLACEMENT PARTS



15 M SYNTHETIC ROPE
2,041 kg SERIES
» 2879187



15 M STEEL CABLE
1,588 kg SERIES
» 2878890

UPGRADE YOUR HD WINCH

WIRELESS REMOTE

- Up to 15 m range with LED indicator
- Direct plug & play operation
- » 2879316



AUTO STOP UPGRADE

- Billeted aluminum
 - Replaces stock fairlead
 - » 2881693
- SYNTHETIC ROPE REQUIRED

> HEATER



HEATER KIT

- Connects to Polaris PULSE Bus Bar to provide reliable, steady heat to your cab with fan speed and temperature control
- Selectable vent positions include driver/passenger, defrost or a combination of both
- Includes two defrost vents and two cabin vents
- Compatible with subwoofer upgrade

» 2884735

TRAIL S '21-'22, TRAIL '21-'22



> PLOWS

TRAIL ACCESSORIES

WINDSHIELDS
& REAR PANELS

ROOF DOORS
& AUDIO

VEHICLE PROTECTION
& STORAGE

WINCHES, HEATER
& PLOWS

LIGHTING & ELECTRICAL
& TRACKS

ACCESSORISZETT

2014-2020 TRAIL

GLACIER[®] HD PLOW SYSTEM

MAKE QUICK WORK OF SMALLER JOBS

Move snow with the tough and capable Glacier HD plow system and discover why a major snowfall can be the highlight of your week. With a robust frame, beefy poly and steel blade options, dismounting and amazing value, Glacier HD is a great choice in the dead of winter.



GLACIER HD GIVES YOU

- » 168 cm blades
- » Choice of poly or steel
- » Manual angle system standard

BUILD A PLOW SYSTEM

	STEP 1 SELECT A MOUNT	STEP 2 SELECT A FRAME	STEP 3 SELECT A LIFT METHOD	STEP 4 SELECT A BLADE	STEP 5 SELECT ACCESSORIES
MODELS	MOUNT	FRAME	WINCH	BLADES	ACCESSORIES
Trail S '21-22 Trail '21-22	Glacier Pro Plow Mount 2884764 2014-2020 Models: Glacier Pro Plow Mount 2880262 \$ 900 '15-20, \$ 4 1000 '19-20, \$ 1000 '16-20, 900 '14-20	Glacier Pro HD Push Frame 2880260	Polaris Pro HD 2,041 kg Winch with Rapid Rope Recovery See P. 44 for details Polaris HD 1,588 kg Winch See P. 44 for details	Glacier Pro Plow Blade 168 cm Poly 2880269 Glacier Pro Plow Blade 168 cm Steel 2880268	168 cm Snow Deflector 2879866 168 cm HD Wear Bar 2879868 168 cm Wear Bar 2879867 Plow Marker 2872726 Skid Shoe 2208864 Shear Pin 2205527 Plow Extension 2880267

BUY A PLOW SYSTEM

NEW
GLACIER HD PLOW SYSTEM

System includes:

- Mount (2884764)
- Frame (2880260)
- 168 cm Poly Plow (2880269)
- Plow Markers (2872726)

» 3880017
TRAIL S '21-22, TRAIL '21-22
REQUIRES WINCH



> LIGHTING & ELECTRICAL



RIGID SR-SERIES 81 CM COMBO LED LIGHT BAR

» LIGHT BAR
2884648

TRAIL S '21-22, TRAIL '21-22

» MOUNT (REQUIRED)
2884650

TRAIL S '21-22, TRAIL '21-22

» HARNESS (REQUIRED)
2884657

TRAIL S '21-22, TRAIL '21-22



POLARIS PULSE UNDERHOOD BUS BAR - 6 POSITION

• If upgrading to have more than three accessories attaching to the underhood PULSE location, replace the 3 Position Bus Bar with the 6 Position Bus Bar

» 2884183

TRAIL S '21-22, TRAIL '21-22

SEE P. 56 FOR ADDITIONAL LIGHTING OPTIONS



PLUG & PLAY ELECTRICAL

POLARIS PULSE IS A REVOLUTIONARY way to provide power to your vehicle, and makes adding electrical accessories a snap.



> TRACKS

Polaris-specific gearing provides 1:1 ratio to:

- Minimize track slip, providing better climbing ability and improved traction in deep snow
- Improve top speed over prior models by approximately 5%
- Reduce operating RPM for a quieter ride
- Improve driveline durability, which allows vehicle to run at a lower RPM, decreasing engine wear

New front dual stabilizer for improved stability

Polaris exclusive optimized hub geometry that minimizes feedback and eases steering effort

Lightweight design provides for better flotation, eases steering effort and provides better vehicle control

Flexible lug design provides the highest level of deep snow performance by lifting up, as opposed to digging down



TRACKS

» NON-EPS MODELS • 2880757

20 FRONT, 18 REAR
FOR USE ON MODELS WITHOUT FACTORY EPS:
TRAIL S '21-'22, TRAIL '21-'22, S 900 '15-'20, S 4 1000 '19-'20,
S 1000 '18-'20, 900 '15-'20

» EPS MODELS • 2880758

18 FRONT, 18 REAR
FOR USE ON MODELS WITH FACTORY-INSTALLED EPS:
TRAIL S '21-'22, TRAIL '21-'22, S 900 '15-'20,
S 4 1000 '19-'20, S 1000 '16-'20, 900 '15-'20

MOUNTS

» NON-EPS MODELS • 2880648

FITS THE FOLLOWING 50" WIDE MODELS:
TRAIL '21-'22, 900 '14-'20

» EPS MODELS • 2880649

FITS THE FOLLOWING 60" WIDE MODELS:
TRAIL S '21-'22, S 900 '15-'20, S 4 1000 '19-'20,
S 1000 '16-'20, 900 '15-'20

PLOW EXTENSION (2880267) REQUIRED FOR USING A PLOW WITH TRACKS
ONLY COMPATIBLE WITH GLACIER PRO HD SYSTEM

TRAIL



ACCESSORIZE YOUR RZR
TO MAKE IT YOURS



TRAIL ACCESSORIES

WINDSHIELDS
& REAR PANELS

ROOF, DOORS
& AUDIO

VEHICLE PROTECTION
& STORAGE

WINCHES, HEATER
& PLOW

LIGHTING & ELECTRICAL
& TRACKS

ACCESSORIZE IT

2014-2020 TRAIL

2014-2020 TRAIL

> ROOFS



LOCK & RIDE

POLY SPORT ROOF TOP SELLER

- Rigid, injection-molded design to eliminate warping in high-heat conditions
- Integrated mounting locations for lighting
- Rugged, textured polyethylene construction for impact and abrasion resistance
- Not compatible with Canvas Upper Doors

COLOR	2-SEAT	4-SEAT <small>NOT SHOWN</small>
MATTE BLACK	2883073	2883074
	S 900 '15-20, S 1000 '16-20, 900 '15-20	S 4 1000 '19-20

GRAPHIC SPORT ROOF

- Weighs only 5 kg (30% lighter than aluminum)
- Won't bend or break upon impact with debris or obstacles
- Sunroof lets in sunlight while keeping you shaded from heat

COLOR	2-SEAT	4-SEAT <small>NOT SHOWN</small>
MATTE BLACK	2881206	2881935
INDY RED	2881607	2881936
	S 900 '15-20, S 1000 '16-20, 900 '14-20	S 4 1000 '19-20

ALUMINUM ROOF TOP SELLER

- Seals to the vehicle frame for the best protection and great integration with other RZR accessories
- Strong and durable 5051 aluminum construction for long-lasting, reliable protection

COLOR	2-SEAT	4-SEAT <small>NOT SHOWN</small>
MATTE BLACK	2881582-458	2881592-458
INDY RED	2881582-293	2881592-293
	S 900 '15-20, S 1000 '16-20, 900 '14-20	S 4 1000 '19-20

> DOORS



ALUMINUM DOORS

- Single-piece stamped aluminum maximizes quality, fit and finish
- Gasket design eliminates rattling and creates a firm seal
- Available with RZR-matched graphics

- » 2-SEAT • 2879510
S 900 '15-20, S 1000 '16-20, 900 '15-20
- » 4-SEAT • 2879843
S 4 1000 '19-20



LOWER DOOR INSERTS TOP SELLER

- Covers the bottom of the door opening, shutting out water and dust
- Durable plastic construction with steel frame
- Includes optional rear bolster panels, not compatible on some models

- » 2-SEAT • 2879509
S 900 '15-20, S 1000 '16-20
- » 4-SEAT • 2879842
S 4 1000 '19-20

> STORAGE



LOWER DOOR STORAGE BAG

- » 127 cm • 2880616
900 '14-20
REQUIRES LOWER DOOR (2880207)
ONLY COMPATIBLE WITH FRONT DOORS



OVERHEAD BAG

- » 2879516
S 900 '15-20, S 4 1000 '19-20, S 1000 '16-20, 900 '14-20



SEE P. 83 FOR MIRRORS

> WINCHES

FEATURES	PRO PRO HEAVY DUTY SERIES	HD HEAVY DUTY SERIES	
RAPID ROPE RECOVERY	STANDARD	NOT AVAILABLE	
AUTO STOP TECHNOLOGY	STANDARD	OPTION	
WINCH LINE	SYNTHETIC ROPE	STEEL CABLE	
CONTROL	WIRELESS STANDARD, WIRED OPTION	WIRED STANDARD, WIRELESS OPTION	
MODEL	2,041 kg	1,588 kg	ADD REQUIRED CABLES
S 900 '15-21, 900 '14-21 S 4 1000 '19-20, S 1000 '16-21	 <p>TOP SELLER 2882240</p>	 <p>2881671</p>	SEE P. 57 FOR BUS BAR HARNESS FITMENT

REPLACEMENT PARTS

15 M SYNTHETIC ROPE	15 M STEEL CABLE
2,041 kg SERIES » 2879187	1,588 kg SERIES » 2878890
	

UPGRADE YOUR CONTROLS UPGRADE YOUR HD WINCH

WIRED REMOTE CONTROL	WIRELESS REMOTE	AUTO STOP UPGRADE
<ul style="list-style-type: none"> Must order remote handle and socket together » REMOTE HANDLE 4013466 » SOCKET 4014228 <p>WORKS WITH 2882240 WORKS WITH 2882240</p>	<ul style="list-style-type: none"> Up to 15 m range with LED indicator Direct plug & play operation » 2879316 	<ul style="list-style-type: none"> Billeted aluminum Replaces stock fairlead » 2881693 <p>SYNTHETIC ROPE REQUIRED</p>

> ROCK SLIDERS

LOW PROFILE ROCK SLIDERS

- Plated steel construction, durable powdercoat finish
- Easy installation with expanded anchor mount



COLOR	2-SEAT	4-SEAT
MATTE BLACK	2879498-458	2879940-458
INDY RED	2881587-293	2881593-293
SKY BLUE	2881587-737	2881593-737

S 900 '15-20, S 1000 '16-20, 900 '14-20 S 4 1000 '19-20

EXTREME KICK-OUT ROCK SLIDERS

- Rugged steel protection and race-inspired styling
- Low-profile mounting location will not diminish ground clearance

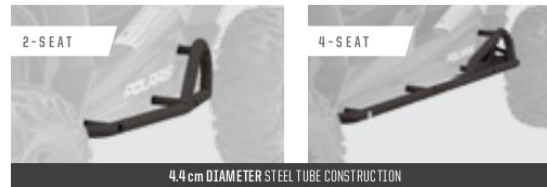

COLOR	2-SEAT	4-SEAT
MATTE BLACK	2879456-458	2882079-458
INDY RED	2881586-293	2882079-293
SKY BLUE	2881586-737	2882079-737

S 900 '15-20, S 1000 '16-20, 900 '14-20 S 4 1000 '19-20

> BUMPERS

LOW PROFILE BUMPER

- Provides more protection and allows for accessory mounting



COLOR	PART NUMBER
MATTE BLACK	2879449-458
INDY RED	2881583-293

S 900 '15-20, S 4 1000 '19-20, S 1000 '16-20, 900 '14-20

EXTREME BUMPER ATTACHMENT

- Provides increased protection around lighting and fenders



COLOR	PART NUMBER
MATTE BLACK	2879451-458

S 900 '15-20, S 4 1000 '19-20, S 1000 '16-20, 900 '14-20
REQUIRES LOW PROFILE FRONT BUMPER (2879449-458, 2881583-293)

FROM DUSK

Extend your ride time and be more visible to others with the brightest light bars in the industry.

RIGID LIGHT BARS P.56

A trusted name in the off-road lighting industry, RIGID delivers unmatched technology and superior performance.



POLARIS HEADLIGHTS AND ACCENTS

Replace your stock headlights, add more lumens to the trail and keep the ride going into the night.

TRAILBLAZER LED ADJUSTABLE HEADLIGHTS

- Direct replacement for factory headlight
- 6,000 lumen total output; 20-watt CREE XHP LED Chips
- Durable construction is waterproof, dustproof and fade resistant
- Integrated LED daytime running light
- Includes six black bezels

» 2882073

TURBO S '18-21, XP TURBO '19-21, TURBO S 4 '20-21, XP 4 TURBO '19-21, XP 4 1000 '14-22, XP 1000 '14-22, S 900 '15-20, S 4 1000 '19-20, S 1000 '16-20, RS1 '18-22, PRO XP '21-22, 900 '14-20

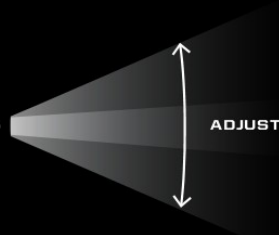

CONTROL BEAM PATTERNS

The Trailblazer LED Headlight features adjustable beams on the inside and outside reflectors. Set the beam to your desired width or focus to dial in your beam pattern.

MIX & MATCH COLOR BEZELS

- Personalize the look of your Trailblazer lights with interchangeable color-matched bezels
- Choose from a variety of colors, or mix and match



COLOR	2-PACK
INDY RED	2882479-293
VELOCITY BLUE	2882479-689

TURBO S '18-21, XP TURBO '15-21, TURBO S 4 '19-21, XP 4 TURBO '16-21, XP 4 1000 '14-22, XP 1000 '14-22, S 900 '15-20, S 4 1000 '19-20, S 1000 '16-20, RS1 '18-22

'TIL DAWN

PRO ARMOR LIGHT BARS P.57

Pro Armor gives you aggressive styling, rugged protection and lighting solutions for your riding needs.

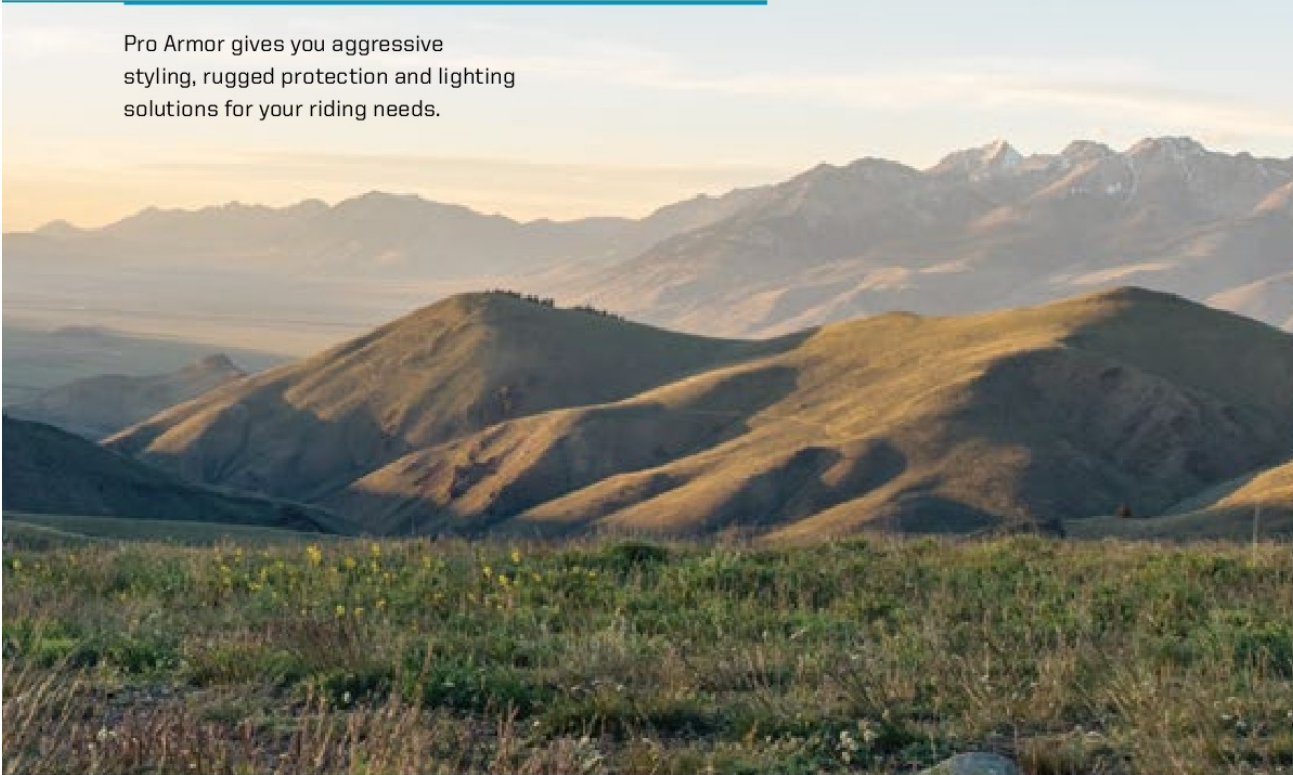

SHOWCASE YOUR STYLE

Be a shining beacon of color when you ride at night. With our colorful line of LED accent lights and headlight bezels, you can stand out from the rest of the pack and create an iconic ride.

FANG ACCENT LIGHTS TOP SELLER

- Includes a pair of front fascia accent lights and a rear, center taillight (rear light with kit only)
- Durable dust and waterproof construction

» FRONT/REAR KIT • 2884053

TURBO S '19-21, XP TURBO '19-21, TURBO S 4 '19-21, XP 4 TURBO '19-21, XP 4 1000 '19-22, XP 1000 '19-22

» FRONT • 2884671

TRAIL S '21-22, TRAIL '21-22, TURBO S '19-21, XP TURBO '19-21, TURBO S 4 '19-21, XP 4 TURBO '19-21, XP 4 1000 '19-22, XP 1000 '19-22



FRONT



REAR

COMMON

LIGHTING

CONNECTED
TECHNOLOGY

AUDIO

WHEELS & TIRES

VEHICLE & RIDER
PROTECTION

COOLERS

COCKPIT ACCESSORIES
& MIRRORS

WINCHES

MISC. STV & YOUTH

BUILD YOUR VISION

OPTICS

ACCENT

DRIVING

FLOOD

USAGE

DIFFUSED COLORED LIGHT ADDED FOR STYLE & PERSONALIZATION

- Durable, dust and water resistant construction
- Ideal for showcasing your lifted vehicle or custom suspension

GREAT FOR ALL RIDING STYLES, TERRAINS OR WORK APPLICATIONS

- Beam: Extra-wide, moderate center intensity
- Recommended Mounting: All points

BEST FOR WIDE-OPEN TERRAINS OR WORK APPLICATIONS REQUIRING BROAD LIGHT

- Beam: Wide, shorter
- Recommended Mounting: Low & rear
- Ideal for medium speeds when peripheral vision is important



DRIVING SPEED

ALL

SLOW TO MEDIUM

SLOW TO MEDIUM

LIGHT ANGLE

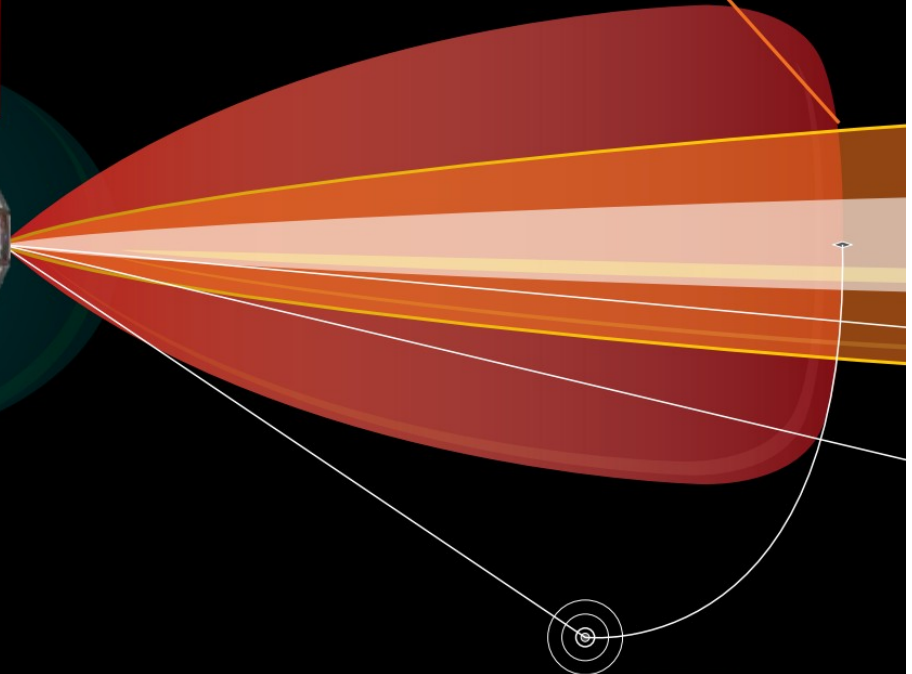
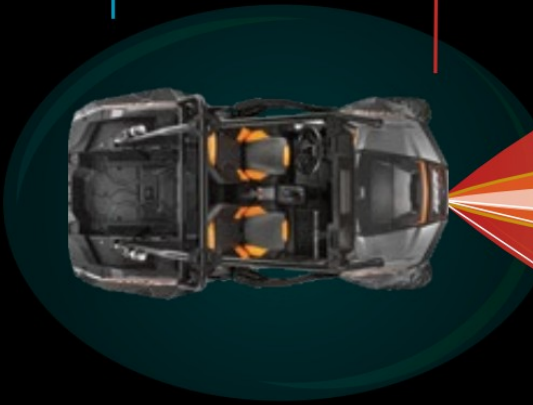

DRIVING
(45°)

SPOT

BEST FOR TIGHT RIDING TERRAINS AND CONDITIONS REQUIRING LONG-DISTANCE VISIBILITY

- Beam: Concentrated long beam
- Recommended Mounting: High
- Ideal for high speeds so you can see and react to your environment

COMBO

ALL-AROUND VERSATILITY FOR ANY RIDING TERRAIN, CONDITION OR WORK APPLICATION

- Beam: Combination of flood and spot optics
- Recommended Mounting: All points
- Ideal for all-around distance visibility



HIGH



ALL

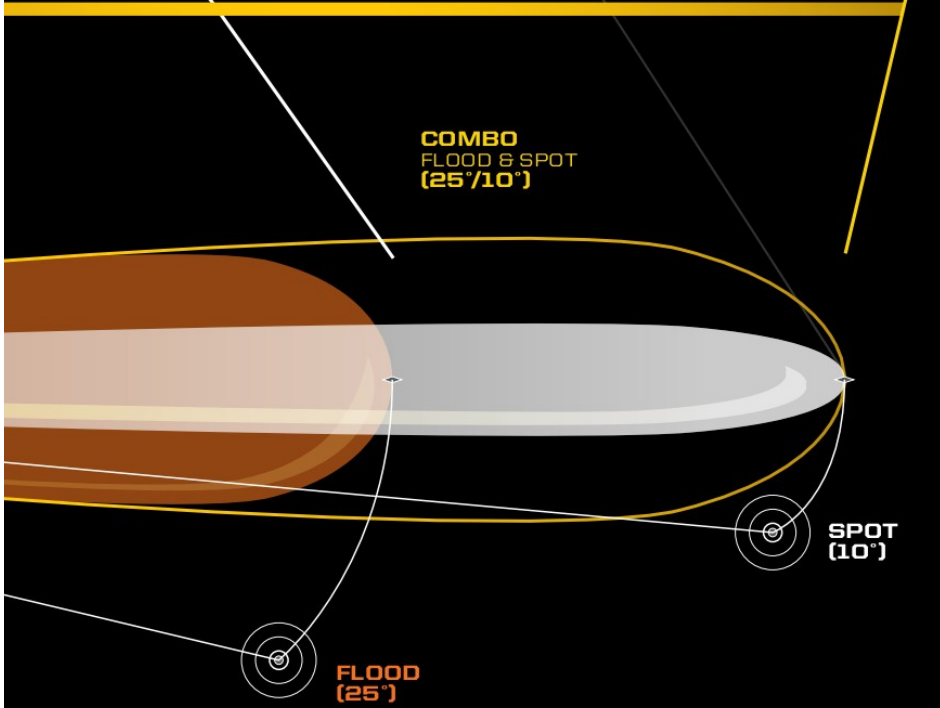



POLARIS ENGINEERED
ADVANTAGES

MOUNTS PERFECTLY
Designed for your Polaris Engineered
bumper, roof or other mounting point

**ADVANCED
TECH**

RIGID lights are driven by Aluminum PCB Smart Boards, 6063-T5 aircraft aluminum extruded housings and Tiger Drylac UV protection polyester powder-coating.

**EXCLUSIVE
OPTICS**

RIGID invests heavily in optical science and has patented multiple optics and optics systems, maximizing light output and efficiency.

LIGHT BAR TYPES



SR-SERIES PRO

Sleek, powerful, low-profile (under 5 cm tall). Lights extreme distances with low energy usage.
Available in 25.4 cm & 81.3 cm



D-SERIES PRO

Compact to fit almost anywhere with high output and low energy usage.
Available in Driving, Flood & Spot

LIGHT BAR OPTIONS

OPTICS

DRIVING FLOOD

SPOT

1200 m
960 m
720 m
480 m
240 m

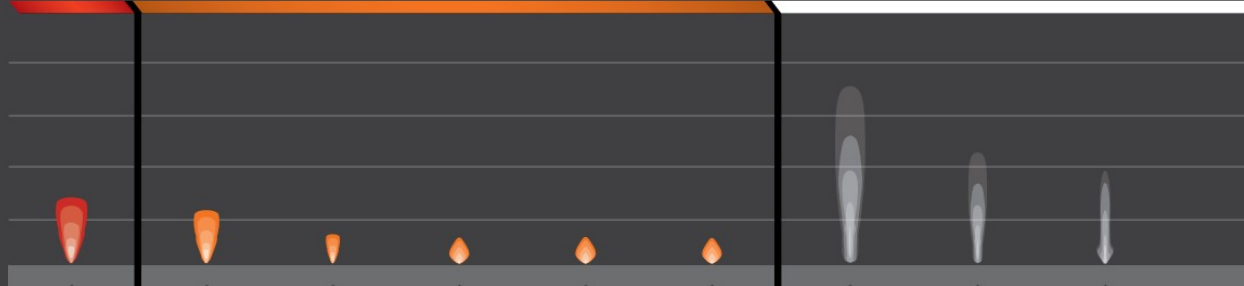

BRAND	RIGID	RIGID	RIGID	PRO ARMOR	PRO ARMOR	PRO ARMOR	RIGID	RIGID	PRO ARMOR
SIZE	POD	25.4 cm	POD	27.9 cm	25.4 cm	CUBE	25.4 cm	POD	27.9 cm
TYPE	D-SERIES	SR-SERIES	D-SERIES	SINGLE-ROW	DUAL-ROW	DUAL-ROW	SR-SERIES	D-SERIES	SINGLE-ROW
RAW LUMENS	4,752	7,920	3,168	1,890	3,780	1,400	7,920	3,168	1,890
PN	2883128	2883122	2883126	2882313	2882311	2882312	2883121	2883127	2882078
	<small>Comes in a pair</small>		<small>Comes in a pair</small>					<small>Comes in a pair</small>	



MAX PERFORMANCE
Validated to work as hard
as your machine does

DOESN'T OVERTAX
Trust it to work when
you need it to

PRO ARMOR



RUGGED CONSTRUCTION

Pro Armor lights are designed to be big and beefy with an aggressive style all their own, and housed in IP67 marine-grade rated UV polyester powder-coating.

MASSIVELY BRIGHT

Pro Armor builds bright lights designed for any riding experience. All that power is directed through heat dissipating aluminum for streamlined heat management.



DUAL-ROW LED LIGHT BARS

The most spread and farthest illumination downrange. Easy to mount.
Available in Cube, 25.4 cm, 50.8 cm & 76.2 cm



SINGLE-ROW LED LIGHT BARS

Powerful, compact, low-profile light bars with a sleek look.
Available in 27.9 cm & 83.8 cm



CUBE LED LIGHTS

Small size allows mounting in strategic locations for added lighting.
Available in Flood & Spot

COMBO

OPTICS

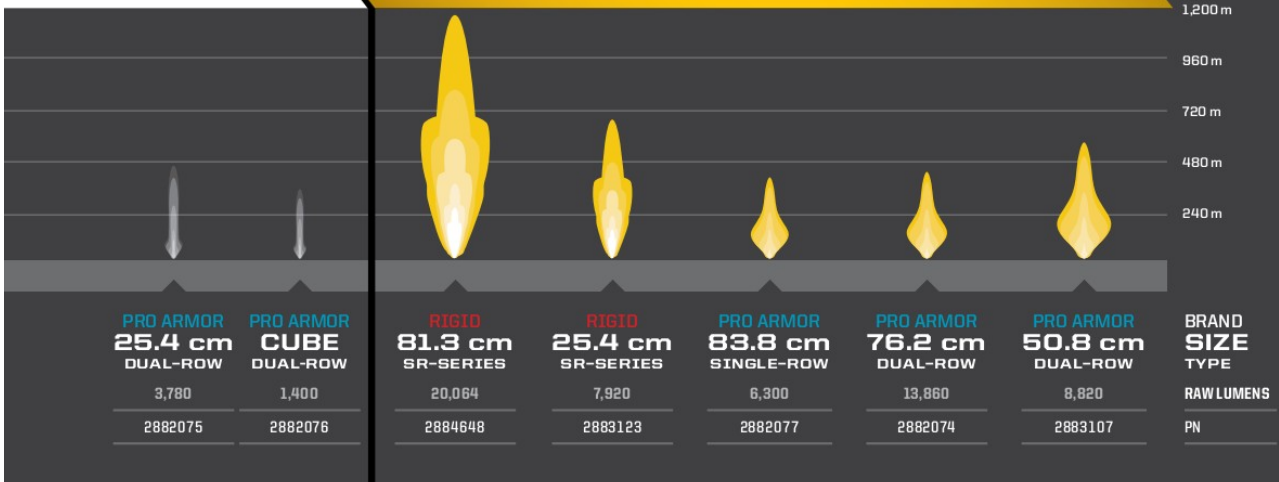

ADD A HARNESS TO MOUNT YOUR LIGHTS

MODEL	LIGHT BAR SET-UPS		
	1 LIGHT IN 1 LOCATION ON 1 SWITCH	2 LIGHTS IN 2 LOCATIONS ON 1 SWITCH	2 LIGHTS IN 2 LOCATIONS ON 2 SWITCHES
TRAILS S '21-22 TRAIL '21-22	LIGHT BAR HARNESS 2884657	LIGHT BAR HARNESS 2884657 ADAPTER HARNESS 2412616 LED Y-HARNESS 2879860	LIGHT BAR HARNESS (x2) 2884657
PRO XP 4 '20-22 PRO XP '20-22	LIGHT BAR HARNESS 2883949 ADAPTER HARNESS 2412616	LIGHT BAR HARNESS 2883949 ADAPTER HARNESS 2412616 LED Y-HARNESS 2879860	LIGHT BAR HARNESS (x2) 2883949 ADAPTER HARNESS (x2) 2412616
RST '18-22	LIGHT BAR HARNESS 2883388	LIGHT BAR HARNESS 2883388 LED Y-HARNESS 2879860	LIGHT BAR HARNESS (x2) 2883388
TURBO S '18-21, TURBO S 4 '19-21 XP TURBO '15-21, XP 4 TURBO '16-21 XP 1000 '14-22, XP 4 1000 '14-22 S 1000 '16-20, S 4 1000 '19-20 S 900 '15-20, 900 '14-20	LIGHT BAR HARNESS 2883486	LIGHT BAR HARNESS 2883486 LED Y-HARNESS 2879860	LIGHT BAR HARNESS (x2) 2883486

ADD BATTERY CONNECTION CABLES FOR POWER

MODEL	BUS BAR HARNESS
PRO XP 4/PRO XP '20-22 TRAIL S '21-22, TRAIL '21-22 RST '18-22 XP 4 TURBO/XP TURBO '17-21 XP 4 1000/XP 1000 '18-22 TURBO S 4 '19-21, TURBO S '18-21	HARNESS NOT REQUIRED
S 900 '16-20 S 1000 '16-20 900 '15-20	2881551
S 4 1000 '19-20	2881646



All RIGID and Pro Armor lights are Polaris PULSE ready.

SEE P. 15 FOR PRO XP LIGHT BAR OPTIONS

COMMON

LIGHTING

CONNECTED TECHNOLOGY

AUDIO

WHEELS & TIRES

VEHICLE & RIDER PROTECTION

COOLERS

COCKPIT ACCESSORIES & MIRRORS

WINCHES

MISC. STV & YOUTH

> CONNECTED TECHNOLOGY



POLARIS RIDECOMMAND

PLAN. TRACK. SHARE. CONNECT.

PLAN YOUR RIDE

Plan an epic ride with stops along the way, customize and adjust your path to maximize your route. You can even share your planned route with friends.

7" DISPLAY POWERED BY RIDE COMMAND

- **Bright, 7" touchscreen** visible in all conditions
- **Pre-Loaded Maps**
Available offline on the in-dash display so you always know where you are.
- **Route Planning**
Add points of interest and waypoints to make the most of your off-road adventure.
- **Camera Integration**
Navigate with full view of your surroundings. Use the integrated rear camera to see others behind you while riding.
- **Personalized Audio Experience**
Seamlessly pair your display via Bluetooth to wirelessly stream music and stay connected with call and text alerts.
- **Configurable Gauges**
Customize your ride experience with elevation, travel direction, fuel level and more to create relevant screens for you.

▶ 2884072

TRAIL S '22, TURBO S '19-21, XP TURBO '19-21, TURBO S 4 '19-21, XP 4 TURBO '19-21, XP 4 1000 '19-22, XP 1000 '19-22, PRO XP 4 '20-22, PRO XP '20-22

7" DISPLAY MOUNT KIT

- Replaces dash for seamless fit and finish
- Includes front and rear cameras with mounts
- Comes with wiring harnesses needed for RZR accessory components
- **RIDE COMMAND Audio Adapter (2883232)** required when adding audio to an XP

▶ 2884584

PRO XP 4 '20-22, PRO XP '20-22

▶ 2884731

TRAIL S '22

▶ 2884021

TURBO S '19-21, XP TURBO '19-21, TURBO S 4 '19-21, XP 4 TURBO '19-21, XP 4 1000 '19-22, XP 1000 '19-22



DISCOVER NEW TRAILS

With almost 1,000,000 miles of trails available offline, you'll have the confidence to explore further, whether you have cellular coverage or not.

RELIVE YOUR RIDE

With 3D flyovers you can track and go over your completed rides, and share your favorite routes with friends even after the ride is over.

FRONT CAMERA KIT TOP SELLER

- Front camera upgrade for increased visibility and safety
- Increases driver awareness of obstacles and terrain for enhanced riding
- All wiring harnesses included on vehicle

» 2884432

TRAILS '22, TURBO S '19-21,
XP TURBO '19-21, TURBO S 4 '19-21, XP 4 TURBO '19-21, XP 4 '1000 '19-22, XP
'1000 '19-22, PRO XP 4 '20-22, PRO XP '20-22

SEE NEXT PAGE TO ADD AUDIO

OFF-ROAD GRADE AUDIO

BUILD YOUR AUDIO SYSTEM

MBQUART®

1 CHOOSE A HEAD UNIT Control all aspects of your sound system. Choose what to listen to and how loud.



7" DISPLAY POWERED BY RIDE COMMAND

- Total command center for a world of connection at your fingertips
- Media player with built in AM/FM tuner for all your favorite music*
- Built in GPS with topography maps to see your location and plan your ride
- Track and share ride stats on the display or in the RIDE COMMAND mobile app

» 2884072

TRAIL S '22, TURBO S '19-21, XP TURBO '19-21, TURBO S 4 '19-21, XP 4 TURBO '19-21, XP 4 1000 '19-22, XP 1000 '19-22
SEE P. 58 FOR REQUIRED MOUNT OPTIONS

SEE P. 58 FOR MORE INFO



BASE UNIT OR ADD SPEAKERS

AUDIO ROOF

- Use as an all-in-one solution or a base unit to build your system
- Four high-efficiency 16.5 cm coaxial speakers for unbeatable sound
- Built in push-button dash radio with Bluetooth and AUX
- Modular design for improved serviceability and access
- Not compatible with RIDE COMMAND

S4 AUDIO ROOF

» 2882064

XP TURBO '15-21, XP 1000 '14-22, S 900 '15-20, S 1000 '16-20, 900 '14-20

S8 AUDIO ROOF

» 2882065

XP TURBO '15-21, XP 1000 '14-22, S 900 '15-20, S 1000 '16-20, 900 '14-20

S10 AUDIO ROOF

» 2882066

XP TURBO '15-21, XP 1000 '14-22, S 900 '15-20, S 1000 '16-20, 900 '14-20

MODEL: S4 S8 S10

(4) 16.5 cm COAXIAL SPEAKERS	✗	✗	✗
(4) 16.5 cm COMPONENT SPEAKERS, MIDS & TWEETERS		✗	✗
(2) 15.2 cm x 22.9 cm COAXIAL SPEAKERS			✗
4-CHANNEL, 2-OHM, 300W AMPLIFIER		✗	✗
83.8 cm SINGLE-ROW PRO ARMOR LIGHT BAR		✗	
76.2 cm DUAL-ROW PRO ARMOR LIGHT BAR			✗
DOME LIGHT		✗	✗



DASH RADIO

- Seamless dash integration and convenient push-button design
- Bluetooth connectivity
- Remote-mounted USB/3.5mm plug for external device connection

» 2881988

XP 1000 '14-22, XP 4 1000 '14-22, XP TURBO '15-21, XP 4 TURBO '16-21, TURBO S '18-21, TURBO S 4 '19-21



Sound Bar 8



Sound Bar 4

SOUND BAR

NOT COMPATIBLE WITH ADDITIONAL/EXTERNAL SPEAKERS OR RIDE COMMAND

- All-in-one solution for a quick and easy audio upgrade to your machine

SOUND BAR 8

- Six mid-range/mid-bass speakers and two dedicated tweeters
- Fully waterproof with large, easy-to-use external controls

» 2881465

XP TURBO '15-21, XP 1000 '14-22, XP 4 TURBO '16-21, XP 4 1000 '14-22, S 900 '15-20, S 4 1000 '19-20, S 1000 '16-20, 900 '14-20
SPEAKER BAR HARNESS (2882280) REQUIRED

SOUND BAR 4

- Two mid-range/mid-bass speakers and two dedicated tweeters

» 2881230

XP TURBO '15-21, XP 1000 '14-22, XP 4 TURBO '16-21, XP 4 1000 '14-22, S 900 '15-20, S 4 1000 '19-20, S 1000 '16-20, 900 '14-20
SPEAKER BAR HARNESS (2882280) REQUIRED

When you research audio solutions, you'll see manufacturers bragging about how their audio equipment is "Marine Grade." Or worse yet, you'll discover they are repackaged components built for automotive applications. MB Quart, in partnership with Polaris, engineers Off-Road Grade Audio equipment that's proven to deliver the loudest, crispest sound in the harshest conditions. Rain, snow, mud, heat, cold, dust –

ANY PLACE YOUR RZR EXCELS, SO WILL YOUR AUDIO.

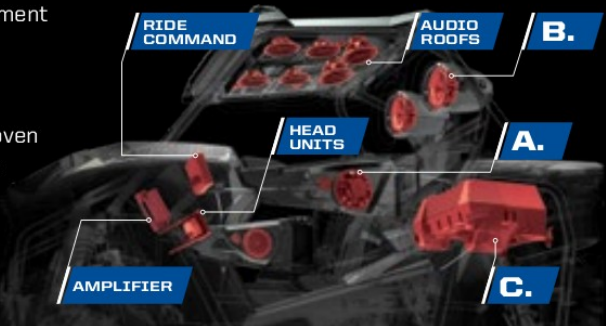

COMMON

LIGHTING

CONNECTED TECHNOLOGY

AUDIO

WHEELS & TIRES

VEHICLE & RIDER PROTECTION

COOLERS

COCKPIT ACCESSORIES & MIRRORS

WINCHES

MISC. STV & YOUTH

2 ADD SPEAKERS - MIX AND MATCH

Build your dream audio system. From a simple setup with only door speakers, to a complex system with door speakers, audio pods and a subwoofer – BUILD IT YOUR WAY.



A. DOOR SPEAKERS TOP SELLER

- High performance 16.5 cm component speakers with 1.9 cm titanium dome tweeters
 - Harnessing included to connect to audio amplifier
 - Works with Polaris Aluminum Door kits or Polaris Lower Door kits
 - Requires Audio Amplifier (2883738, 2884064) when used with RIDE COMMAND
- » **FRONT • 2881989** (Set of two)
TURBO S '18-21, XP TURBO '15-21, TURBO S 4 '19-21, XP 4 TURBO '15-21, XP 4 1000 '14-22, XP 1000 '14-22, S 900 '15-20, S 4 1000 '19-20, S 1000 '16-20
Not compatible with DYNAMIX ACTIVE SUSPENSION MODELS
- » **REAR • 2883116** (Set of two)
TURBO S 4 '19-21, XP 4 TURBO '16-21, XP 4 1000 '14-22, S 4 1000 '19-20
REQUIRES FRONT DOOR SPEAKERS (2881989). CONNECTS DIRECTLY TO AUDIO AMPLIFIER (2884064). NO ADDITIONAL AMPLIFIER NEEDED. NOT COMPATIBLE WITH AUDIO ROOFS.



B. EXTREME AUDIO PODS

- Two 20.3 cm coaxial speakers with 2.5 cm titanium tweeters in weatherproof enclosures
 - Self-amplified 200-watt per speaker output
 - Rear Audio Harness included
- » **2883739**
TURBO S '18-21, XP TURBO '15-21, TURBO S 4 '19-21, XP 4 TURBO '16-21, XP 4 1000 '14-22, XP 1000 '14-22, S 900 '15-20, S 4 1000 '19-20, S 1000 '16-20, 900 '15-20



C. 30.5 cm MAXBOOST SUBWOOFER

- High-strength molded enclosure for optimal acoustics and superior fit
 - Lock & Ride connectivity to cargo bed
 - Integrated 250-watt Class D amplifier
 - Deep bass 30.5 cm subwoofer with 5.1 cm voice coil
 - Wiring harness included
- » **2882063**
TURBO S '18-21, XP TURBO '15-21, TURBO S 4 '19-21, XP 4 TURBO '16-21, XP 4 1000 '14-22, XP 1000 '14-22, S 900 '15-20, S 4 1000 '19-20, S 1000 '16-20, 900 '15-20

3 MAKE IT WORK

BUS BAR HARNESS

VEHICLE FITMENT	BUS BAR HARNESS
RS1 '18-22 XP TURBO/XP 4 TURBO '17-21 XP 1000/XP 4 1000 '18-22 TURBO S '18-21, TURBO S 4 '19-21	HARNESS NOT REQUIRED
S 900 '16-20, 900 '15-20 S 1000 '16-20	2881551
S 4 1000 '19-20	2881646

AUDIO Y-HARNESS

- Y-Harness splits the audio signal to allow for additional audio components to be added
- » **2883269**
TURBO S '18-21, XP TURBO '19-21, TURBO S 4 '20-21, XP 4 TURBO '19-21, XP 4 1000 '14-22, XP 1000 '14-22, S 900 '15-20, S 4 1000 '19-20, S 1000 '16-20, 900 '14-20

LINE-OUT AUDIO HARNESS

- Designed to extend JST audio signal from rear of audio roof to the front of the vehicle
- » **2881652**
TURBO S '18-21, XP TURBO '19-21, TURBO S 4 '20-21, XP 4 TURBO '19-21, XP 4 1000 '14-22, XP 1000 '14-22, S 900 '15-20, S 4 1000 '19-20, S 1000 '16-20, 900 '14-20

RIDE COMMAND ONLY

RIDE COMMAND AUDIO ADAPTER

- Required to hook up any audio RIDE COMMAND system
 - Connect up to two speaker options and subwoofer
 - Specifically designed for subwoofer
- » **2883232**
TURBO S '18-21, XP TURBO '19-21, TURBO S 4 '20-21, XP 4 TURBO '19-21, XP 4 1000 '14-22, XP 1000 '14-22, S 900 '15-20, S 4 1000 '19-20, S 1000 '16-20, 900 '15-20
REQUIRED WHEN ADDING AUDIO TO 7" DISPLAY (2884072)
DOOR SPEAKERS AND AUDIO AMPLIFIER NOT RECOMMENDED WITH DYNAMIX ACTIVE SUSPENSION MODELS

SOUND BARS ONLY

SPEAKER BAR HARNESS

- Used to connect sound bar to accessory bus bar for power
- » **2882280**
TURBO S '18-21, XP TURBO '19-21, TURBO S 4 '20-21, XP 4 TURBO '19-21, XP 4 1000 '14-22, XP 1000 '14-22, S 900 '15-20, S 4 1000 '19-20, S 1000 '16-20, 900 '14-20
BUS BAR HARNESS (2881551, 2881646) REQUIRED

DOOR SPEAKERS ONLY

AUDIO AMPLIFIER

- 200-watt, TDA-based, full-range, Class D amplifier with fixed connections for power, ground and turn-on and Delphi connectors for door speakers
 - Required with Door Speakers (2881989, 2883116)
- » **2883738**
S 900 '15-20, S 4 1000 '19-20, S 1000 '16-20, 900 '15-20
- » **2884064**
TURBO S '18-21, XP TURBO '19-21, TURBO S 4 '20-21, XP 4 TURBO '19-21, XP 4 1000 '19-22, XP 1000 '19-22



PRO ARMOR[®]

TIRES





DOMINATE ANY ENVIRONMENT

FIND THE RIGHT PRO ARMOR TIRE FOR YOUR RZR

Developed and tested with Polaris engineers, ensuring the perfect fit and optimal performance mile after mile.



For off-road use only. Please check fitment with your dealer.

COMMON

LIGHTING

CONNECTED TECHNOLOGY

AUDIO

WHEELS & TIRES

VEHICLE & RIDER PROTECTION

COOLERS

COCKPIT ACCESSORIES & MIRRORS

WINCHES

MISC. STV & YOUTH

KNOW YOUR TERRAIN



- Tread patterns optimized for extreme traction
- Ideal for both hard pack and loose trail



- Flexible "grippy" tread
- Aggressive side bite



- Provides traction and durability
- Built to perform in hard sand, jagged rocks or any other extreme terrain

SUPERIOR PERFORMANCE & DURABILITY

LIFELONG PERFORMANCE

- Every tire is designed and constructed with longevity in mind
- 3,000+ mile rated (4,828 kilometers)

PREMIUM PROTECTION

- Pro Armor makes tires with extra protection exactly where it's needed most – the sidewall
- Triple-belted sidewalls keep your tires more resistant so you can keep going

TOUGH TIRES

- Higher ply ratings mean added protection
- Pro Armor builds 8 or 10-ply rated tires for higher puncture-resistance



KNOW YOUR TIRES

DIMENSIONS

TIRE HEIGHT TIRE WIDTH WHEEL DIAMETER

32" x 9" R15
Part Number

FRONT/
REAR

TREAD DEPTH

30mm

TIRE WEIGHT

18 kg

PLY RATING

10

SIDEWALL BELTS

3

LOAD RATING

499 kg

TREAD DEPTH

Deeper treads have more grip in all conditions

PLY RATING

Indicates tire puncture-resistance

LOAD RATING

How much weight can the tire handle

USAGE

Where can you use the tire

TIRE WEIGHT

A lighter tire makes for improved vehicle performance

SIDEWALL BELTS

Increase your resistance to sidewall punctures



- Extra deep treads
- Self-cleaning lugs



- Paddles provide traction and durability in soft sand
- Built to float on top of sand



- Triple-belted sidewalls to resist puncture
- Purpose-built, long lasting tread patterns



- Handles extreme cold
- Holds shape and provides traction

WAYS TO SHOP

WHEELS & TIRES

TIRES BY SIZE

26"	27"	28"	29"	30"	32"	33"
DUAL-THREAT	MUD XC	ATTACK 2.0	MUD XC	ATTACK 2.0	DUAL-THREAT	CRAWLER XR
ATTACK	WHITEOUT	CRAWLER XR	DUAL-THREAT	SAND 12XT	CRAWLER XG	PRO RUNNER
		CRAWLER XG	HD-K	CRAWLER XG	CRAWLER XR	
				WHITEOUT	SAND 16XT	
				PRO RUNNER	PRO RUNNER	
				CRAWLER AT	MUD XT	
				SAND 16XT	CRAWLER AT	

TIRES BY TERRAIN

TRAIL	ROCK	DESERT	MUD	SAND	SNOW
ATTACK 2.0	ATTACK 2.0	ATTACK 2.0	MUD XC	SAND 12XT	ATTACK 2.0
ATTACK	DUAL-THREAT	ATTACK	MUD XT	SAND 16XT	ATTACK
DUAL-THREAT	CRAWLER XR	DUAL-THREAT			WHITEOUT
MUD XC	CRAWLER XG	CRAWLER XR			HD-K
CRAWLER XR	PRO RUNNER	CRAWLER XG			
CRAWLER XG	CRAWLER AT	PRO RUNNER			
PRO RUNNER		CRAWLER AT			
HD-K					
CRAWLER AT					

WHEELS BY SIZE

14"	15"	16"
40-SERIES (8 TIRE OPTIONS)	50-SERIES (9 TIRE OPTIONS)	60-SERIES (1 TIRE OPTION)
4201	5101	6301 BEADLOCK
4202	5201	
4203 BEADLOCK	5202	
4204	5203 BEADLOCK	
4205	5204	
4206	5205	
4301 BEADLOCK	5301 BEADLOCK	
4302 BEADLOCK		
4303		
HD DUAL BEADLOCK		

KNOW YOUR WHEELS

STEP 1: SELECT YOUR SERIES

4 = 40-SERIES 5 = 50-SERIES 6 = 60-SERIES

STEP 2: CHOOSE YOUR LOAD RATING

1 = <362.9 kg 2 = 363 - 589.7 kg 3 = 590 - 726+ kg

STEP 3: PICK YOUR STYLE

OFFSET / BEADLOCK / COLOR

INCREASE OFFSET FROM STOCK = NARROWER STANCE
DECREASE OFFSET FROM STOCK = WIDER STANCE

For off-road use only. Please check fitment with your dealer.

COMMON

LIGHTING

CONNECTED TECHNOLOGY

AUDIO

WHEELS & TIRES

VEHICLE & RIDER PROTECTION

COOLERS

COCKPIT ACCESSORIES & MIRRORS

WINCHES

MISC. STV & YOUTH

TIRES



FRONT/REAR

PRO ARMOR ATTACK 2.0

- Engineered for excellent hard pack performance
- Dual-compound technology and radial construction offer performance in all terrains
- Tight thread pattern for quieter ride

			TREAD DEPTH	TIRE WEIGHT	PLY RATING	SIDEWALL BELTS	LOAD RATING
15"	28" x 10" R15 5416344	FRONT/ REAR	25mm	15 kg	10	3	499 kg
15"	30" x 10" R15 5416345			17 kg			560 kg



WHEEL SIZE

15"

ATTACK 2.0

TIGHTER TREAD PATTERN =
Better traction in hard pack

DUAL-DUROMETER LUG =
Increased grip & traction in rough terrain, smoother ride in all terrain

10-PLY RATED =
Increased durability

LARGER 28" & 30" SIZE OFFERING =
More ground clearance & trail traction



FRONT/REAR

PRO ARMOR ATTACK

- The best all-purpose tire for all-season traction in any terrain
- Unique, full-face tread design
- Harder durometer lugs promote extended wear, increasing tire life
- Wider spaced lugs provide more grip in softer terrain

			TREAD DEPTH	TIRE WEIGHT	PLY RATING	SIDEWALL BELTS	LOAD RATING
14"	26" x 9" R14 5415613	FRONT	23mm	13 kg	8	3	413 kg
14"	26" x 11" R14 5415614	REAR		15 kg			599 kg



WHEEL SIZE

14"



FRONT/REAR

PRO ARMOR DUAL-THREAT

- Dual-compound technology and radial construction offer performance in all terrains
- Softer durometer rubber on outer edge for overall superior grip and feel
- Harder durometer rubber in the middle for increased traction during acceleration and longer tread life

		TREAD DEPTH	TIRE WEIGHT	PLY RATING	SIDEWALL BELTS	LOAD RATING
14"	26" x 9" R14 5416340	FRONT	12 kg			413 kg
14"	26" x 11" R14 5416341	REAR	14 kg			504 kg
14"	29" x 9" R14 5416342	FRONT	14 kg	10	3	504 kg
14"	29" x 11" R14 5416343	REAR	16 kg			599 kg
15"	32" x 10" R15 5416753	FRONT/REAR	17 kg			902 kg



WHEEL SIZE

14" 15"

DUAL-COMPOUND =
MORE GRIP + LONGER LIFE

Firmer Durometer Rubber = Longer Life



Softer Durometer Rubber = More Grip



FRONT/REAR

PRO ARMOR PRO RUNNER

- Designed to be lightweight, high-performance and quicker in corners/flats
- Triple-belted sidewalls offer extra protection where it's needed the most
- Lug separation provides a great grip and an easy clean in mud and sand

		TREAD DEPTH	TIRE WEIGHT	PLY RATING	SIDEWALL BELTS	LOAD RATING
15"	30" x 9" R15 5417531		13 kg			531 kg
15"	32" x 9.5" R15 5417532	FRONT/REAR	16 kg	8	3	630 kg
15"	33" x 9.5" R15 5417533		17 kg			671 kg



WHEEL SIZE

15"

For off-road use only. Please check fitment with your dealer.

TIRES



FRONT/REAR

PRO ARMOR CRAWLER XR

- Premium grip for all terrains, from the trail to the rocks
- Square block profile for even surface contact
- A tougher durometer than the XG to take on the toughest a trail has to offer

		TREAD DEPTH	TIRE WEIGHT	PLY RATING	SIDEWALL BELTS	LOAD RATING			
14"	28" x 10" R14 5415536	FRONT/ REAR	16mm	15 kg	8	3	517 kg		
14"	32" x 10" R15 5416114							18 kg	630 kg
15"	33" x 10" R15 5417174							18 kg	630 kg



WHEEL SIZE

14"

15"



FRONT/REAR

NEW PRO ARMOR CRAWLER AT

- Directional tread for optimal performance
- Greater lug separation for easy mud clean out
- 8-ply, triple-belted ballistic sidewalls resist punctures

		TREAD DEPTH	TIRE WEIGHT	PLY RATING	SIDEWALL BELTS	LOAD RATING	
14"	30" x 10" R15 5417534	FRONT/ REAR	18mm	16 kg	8	3	580 kg
15"	32" x 10" R15 5417535						



WHEEL SIZE

15"



FRONT/REAR

PRO ARMOR CRAWLER XG

- Built to crawl over all obstacles, both large and small
- A soft, sticky compound makes this tire ideal for both rock crawling and desert running
- 8-ply, triple-belted ballistic sidewalls resist punctures

		TREAD DEPTH	TIRE WEIGHT	PLY RATING	SIDEWALL BELTS	LOAD RATING
14"	30" x 10" R14 5416616	FRONT/ REAR	20mm	8	3	17 kg
14"	32" x 10" R14 5416113					19 kg
15"	28" x 10" R15 5416346					15 kg
15"	30" x 10" R15 5416397					18 kg
16"	32" x 10.5" R16 5416401					20 kg
						581 kg
						644 kg
						499 kg
						581 kg
						644 kg



WHAT CRAWLER ARE YOU?



XR

SINGLE DUROMETER

- Smaller lug height and single durometer gives this high-speed tire added rigidity and lateral stability when cornering
- Unique lug design excels in hard pack, fast terrain



XG

DUAL-DUROMETER

- Taller lug height and dual-durometer construction
- Perfect balance between high-speed performance, durability and flex in order to grip slick rock



AT

DIRECTIONAL LUG PATTERN

- The same taller lug height as Crawler XG, providing more grip and better traction
- Wider lug spacing for excellent mud clean-out

For off-road use only. Please check fitment with your dealer.

TIRES



FRONT

REAR

PRO ARMOR SAND 12XT

- Unique 3-tier concave design on front tires
- Wider rear tires for more traction, plus better grip and flotation on the sand
- 12 paddles for optimized performance on non-Turbo models
- 28mm paddle depth specifically designed for increased traction, while limiting sand throw

		TREAD DEPTH	TIRE WEIGHT	PLY RATING	SIDEWALL BELTS	LOAD RATING
14"	30" x 11" R14 5415251	FRONT 12.8mm	10 kg	8	2	388 kg
14"	30" x 13" R14 5416949	REAR 28mm	11 kg	4		476 kg



WHEEL SIZE

14"

WHAT PADDLE ARE YOU?



12 PADDLE

- 30" (Non-turbo RZR models)
- Fewer paddles for non-turbo/ lower HP applications
- Perfect grip balance to maintain wheel speed



16 PADDLE

- 30" (Turbo RZR models)
- 32" (Turbo S and Velocity)
- Plenty of aggressive paddles for high HP vehicles
- Superior grip for wide-open sand riding



FRONT

REAR

PRO ARMOR SAND 16XT

- Unique 3-tier concave design on front tires
- Wider rear tires with additional paddles for more traction, better grip and flotation on the sand
- 16 paddles for optimized performance and traction on Turbo models
- 28mm paddle depth specifically designed for increased traction, while limiting sand throw

		TREAD DEPTH	TIRE WEIGHT	PLY RATING	SIDEWALL BELTS	LOAD RATING	
15"	30" x 11" R15 5416951	FRONT	13mm	10 kg	4	2	388 kg
15"	30" x 14" R15 5416953	REAR	28mm	15 kg			420 kg
15"	32" x 12" R15 5416952	FRONT	13mm	12 kg			463 kg
15"	32" x 15" R15 5416950	REAR	28mm	16 kg			581 kg



WHEEL SIZE

15"

For off-road use only. Please check fitment with your dealer.

TIRES



FRONT/REAR

PRO ARMOR MUD XC

- Designed as the perfect mud-trail crossover for a smooth ride on the trail and aggressive traction in the mud
- Dual-compound technology with harder durometer lugs promote extended wear, increasing tire life
- 10-ply construction means added protection in the toughest terrain

		TREAD DEPTH	TIRE WEIGHT	PLY RATING	SIDEWALL BELTS	LOAD RATING
14"	27" x 9" R14 5416947	FRONT	14 kg	10	3	531 kg
14"	27" x 11" R14 5416948	REAR	14.5 kg			599 kg
14"	29" x 10" R14 5416946	FRONT/ REAR	18 kg			41 kg



WHEEL SIZE

14"



FRONT/REAR

PRO ARMOR MUD XT

- Aggressive traction in the mud
- Dual-compound technology with harder durometer lugs to promote extended wear and increase tire life
- 10-ply construction for added protection in the toughest terrain

		TREAD DEPTH	TIRE WEIGHT	PLY RATING	SIDEWALL BELTS	LOAD RATING	
15"	32" x 9" R15 5417530	FRONT/ REAR	30mm	18 kg	10	3	599 kg



WHEEL SIZE

15"



FRONT/REAR

PRO ARMOR HD-K

- Designed to provide a smooth ride and aggressive traction in all riding terrains
- Triple-belted sidewall provides extreme protection and extends the tire life
- Quad belt tread core offers superior protection and longer tread life

		TREAD DEPTH	TIRE WEIGHT	PLY RATING	SIDEWALL BELTS	LOAD RATING	
14"	29" x 10" R14 5417507	FRONT/ REAR	3175mm	18 kg	10	3/1 Aramid	599 kg

WHEEL SIZE

14"



FRONT/REAR

PRO ARMOR WHITEOUT

- Extra wide tires for flotation in snow
- Cross-hatched tread pattern designed for superior snow traction with limited digging
- 2-ply sidewall designed to balloon for maximum use of its 15" wide contact patch
- Stud compatible

		TREAD DEPTH	TIRE WEIGHT	PLY RATING	SIDEWALL BELTS	LOAD RATING
14"	27" x 14" R14 5416032	FRONT	16mm	11 kg	8	424 kg
15"	30" x 15" R15 5416395	FRONT/ REAR	17mm	21 kg	2	531 kg

WHEEL SIZE

14"

15"



MORE SURFACE AREA FOR BETTER FLOTATION ON SNOW

Snow-specific tire for trails and deep powder. Features an extra wide, bias-ply construction that can run at low pressures for maximum flexibility. High-flotation performance maintains critical vehicle ground clearance in the snow.



BEADLOCK INCLUDED



BEADLOCK REQUIRED



BEADLOCK INCLUDED

16"

15"

60-SERIES

A 6301 BEADLOCK

WEIGHT: 8.6 kg | LOAD RATING: 726 kg | OFFSET: -98

ACCENT: FRONT/REAR 16" x 7" 1523286
MATTE BLACK: FRONT/REAR 16" x 7" 1523285

50-SERIES

B 5101 O

WEIGHT: 6.6 kg | LOAD RATING: 363 kg | OFFSET: -5

MATTE BLACK: FRONT/REAR 15" x 10" 1523149-458

C 5201

WEIGHT: 7.8 kg | LOAD RATING: 590 kg | OFFSET: +4

ACCENT: FRONT/REAR 15" x 7" 1523184-266
MATTE BLACK: FRONT/REAR 15" x 7" 1523184-458

D 5202

WEIGHT: 8.1 kg | LOAD RATING: 590 kg | OFFSET: +4

ACCENT: FRONT/REAR 15" x 7" 1523102-266
MATTE BLACK: FRONT/REAR 15" x 7" 1523102-458

E 5203 BEADLOCK O O

WEIGHT: 7.3 kg | LOAD RATING: 590 kg | OFFSET: +38

MATTE BLACK: FRONT/REAR 15" x 7" 1522435-458

F 5204 O

WEIGHT: 6.1 kg | LOAD RATING: 690 kg | OFFSET: +55

MATTE BLACK: FRONT/REAR 15" x 7" 1522550-458

G 5205

FRONT WEIGHT: 6.8 kg | LOAD RATING: 408.2 kg | OFFSET: -4
REAR WEIGHT: 9.1 kg | LOAD RATING: 408.2 kg | OFFSET: -38

MATTE BLACK: FRONT 15" x 8" 1523727-458
REAR 15" x 10" 1523728-458

H 5301 BEADLOCK

WEIGHT: 7.7 kg | LOAD RATING: 726 kg | OFFSET: +38

ACCENT: FRONT/REAR 15" x 7" 1523282
MATTE BLACK: FRONT/REAR 15" x 7" 1523286

KNOW YOUR WHEELS

STEP 1: SELECT SERIES

- 4 = 40-SERIES
- 5 = 50-SERIES
- 6 = 60-SERIES

STEP 2: CHOOSE LOAD RATING

- 1 = <362.9 kg
- 2 = 363 - 589.7 kg
- 3 = 590 - 726+ kg

STEP 3: PICK STYLE

OFFSET / BEADLOCK / COLOR

INCREASE OFFSET FROM STOCK = NARROWER STANCE
DECREASE OFFSET FROM STOCK = WIDER STANCE

REPLACEMENT CAPS					
POLARIS CAPS			PRO ARMOR CAPS		
LUSTER	ALL WHEELS EXCEPT 5204 & 5203 BEADLOCK	1521509-410	LUSTER	ALL WHEELS EXCEPT 5204 & 5203 BEADLOCK	5453209-410
MATTE BLACK		1521509-521	MATTE BLACK		5453209-458
LUSTER	5203 BEADLOCK	1522243-410	MATTE BLACK	5204	1523063-458
MATTE BLACK		1522243-458	LUSTER	5203 BEADLOCK	1523015-410
HD MATTE BLACK	ALL WHEELS	5457498-458	MATTE BLACK		

LUG NUTS

12mm x 1.5 SPLINED LUG NUTS

16 LUG NUTS WITH WRENCH	TRAIL S '21-22, TRAIL '21-22, TURBO S '18-21, XP TURBO '19-21, TURBO S 4 '20-21, XP 4 TURBO '19-21	2879332
4 LUG NUTS WITHOUT WRENCH	XP 4 1000 '14-22, XP 1000 '14-22, S 900 '15-20, S 4 1000 '19-20, S 1000 '16-20, PRO XP '21-22, 900 '14-20	2879331
SPLINED LUG WRENCH	TRAIL S '21-22, TRAIL '21-22, TURBO S '18-21, XP TURBO '19-21, TURBO S 4 '20-21, XP 4 TURBO '19-21, XP 4 1000 '14-22, XP 1000 '14-22, S 900 '15-20, S 4 1000 '19-20, S 1000 '16-20, RS1 '18-22, PRO XP '21-22, 900 '14-20	2204966

WHEELS

COMMON

LIGHTING

CONNECTED TECHNOLOGY

AUDIO

WHEELS & TIRES

VEHICLE & RIDER PROTECTION

COOLERS

COCKPIT ACCESSORIES & MIRRORS

WINCHES

MISC. STV & YOUTH



40-SERIES

I 4201

FRONT WEIGHT: 5.9 kg | LOAD RATING: 408.2 kg | OFFSET: -4
REAR WEIGHT: 6.4 kg | LOAD RATING: 590 kg | OFFSET: -9

ACCENT: FRONT 14" x 7" 1522956-266
REAR 14" x 8" 1522957-266

MATTE BLACK: FRONT 14" x 7" 1522956-458
REAR 14" x 8" 1522957-458

NOT COMPATIBLE WITH XP 4 1000/1000 '18-22, XP 4 TURBO/TURBO '18-19

J 4202

FRONT WEIGHT: 5.8 kg | LOAD RATING: 408.2 kg | OFFSET: -4
REAR WEIGHT: 6.1 kg | LOAD RATING: 590 kg | OFFSET: -9

ACCENT: FRONT 14" x 7" 1522544-266
REAR 14" x 8" 1522545-266

MATTE BLACK: FRONT 14" x 7" 1522544-458
REAR 14" x 8" 1522545-458

NOT COMPATIBLE WITH XP 4 1000/1000 '18-22, XP 4 TURBO/TURBO '18-19

K 4203 BEADLOCK

FRONT WEIGHT: 5.9 kg | LOAD RATING: 408.2 kg | OFFSET: -4
REAR WEIGHT: 6.6 kg | LOAD RATING: 590 kg | OFFSET: -9

MATTE BLACK: FRONT 14" x 7" 1522238-458
REAR 14" x 8" 1522239-458

L 4204

FRONT WEIGHT: 5.9 kg | LOAD RATING: 408.2 kg | OFFSET: -4
REAR WEIGHT: 6.4 kg | LOAD RATING: 590 kg | OFFSET: -9

ACCENT: FRONT 14" x 7" 1522546-266
REAR 14" x 8" 1522547-266

MATTE BLACK: FRONT 14" x 7" 1522546-458
REAR 14" x 8" 1522547-458

M 4205

FRONT WEIGHT: 4.8 kg | LOAD RATING: 408.3 kg | OFFSET: -4
REAR WEIGHT: 5.7 kg | LOAD RATING: 590 kg | OFFSET: -9

MATTE BLACK: FRONT 14" x 7" 1521507-521
REAR 14" x 8" 1521508-521

LUSTER: FRONT 14" x 7" 1521507-410
REAR 14" x 8" 1521508-410

N 4206

FRONT WEIGHT: 4.3 kg | LOAD RATING: 408.2 kg | OFFSET: -4
REAR WEIGHT: 4.9 kg | LOAD RATING: 590 kg | OFFSET: -9

MATTE BLACK: FRONT 14" x 6" 1522542-458
REAR 14" x 8" 1522543-458

O 4301 BEADLOCK

WEIGHT: 7.3 kg | LOAD RATING: 726 kg | OFFSET: +38

ACCENT: FRONT/REAR 14" x 7" 1523284

MATTE BLACK: FRONT/REAR 14" x 7" 1523283

NOT COMPATIBLE WITH XP 4 1000/1000 '18-22, XP 4 TURBO/TURBO '18-19

P 4302 BEADLOCK

WEIGHT: 18.1 kg | LOAD RATING: 725.7 kg | OFFSET: +58

MATTE BLACK: FRONT/REAR 14" x 7" 5418036

Q 4303

WEIGHT: 18.1 kg | LOAD RATING: 725.7 kg | OFFSET: +58

MATTE BLACK: FRONT/REAR 14" x 7" 5418037

R HD DUAL BEADLOCK

WEIGHT: 18.1 kg | LOAD RATING: 725.7 kg | OFFSET: +28

MATTE BLACK: FRONT/REAR 14" x 7" 1524022-458

LUG NUTS REQUIRED

.95 cm - 24 HEX LUG NUTS

16 HEX LUG NUTS	570 '13-22	2877409
4 HEX LUG NUTS		2876754



FORGED BEADLOCK RINGS

BEADLOCK REQUIRED

14" BEADLOCK RINGS

4203 BEADLOCK & HD DUAL BEADLOCK (INCLUDES BOLTS)
MACHINED: 1522244-266

4301 BEADLOCK REPLACEMENT & HD DUAL BEADLOCK
MACHINED: 1523146-458



15" BEADLOCK RINGS

5203 BEADLOCK (INCLUDES BOLTS)
MACHINED: 1522240-266

5301 BEADLOCK REPLACEMENT
MACHINED: 1523147-458



For off-road use only. Please check fitment with your dealer.

KNOW YOUR TERRAIN



- Tread patterns optimized for extreme traction
- Ideal for both hard pack and loose trail



- Flexible "grippy" tread
- Aggressive side bite



- Provides traction and durability
- Built to perform in hard sand, jagged rocks or any other extreme terrain

WHEEL & TIRE SETS



40-SERIES

BACKCOUNTRY/TRAIL

MUD

	DUAL-THREAT 26"	DUAL-THREAT 29"	ATTACK 26"	MUD XC 27"	MUD XC 29"
4201 Accent	2883138	2883146	2882390	2884272	2884265
4201 Matte Black	2883139	2883147	2882391	2884273	2884266
4202 Accent	2883140	2883148	2881335	2884267	2884260
4202 Matte Black	2883141	2883149	2881336	2884268	2884261
4203 BEADLOCK Matte Black BEADLOCKS SOLD SEPARATELY			2881381		
4204 Accent	2883142	2883150	2881347	2884270	2884263
4204 Matte Black	2883143	2883151	2881348	2884271	2884264
4205 Luster			2881359		
4205 Matte Black	2883144	2883152	2881360	2884269	2884262
4206 Matte Black	2883145	2883153	2881404		
4301 BEADLOCK Accent BEADLOCKS PRE-MOUNTED	2883217	2883219			
4301 BEADLOCK Matte Black BEADLOCKS PRE-MOUNTED	2883216	2883218			
NEW 4302 BEADLOCK Matte Black BEADLOCKS PRE-MOUNTED	2889550	2889551	2889549	2889552	2889553
NEW 4303 Matte Black	2889542	2889543	2889541	2889544	2889545



50-SERIES

BACKCOUNTRY/TRAIL

MUD

DESERT/ROCK

	DUAL-THREAT 32"	ATTACK 2.0 28"	ATTACK 2.0 30"	MUD XT 32"	PRO RUNNER 30"	PRO RUNNER 32"	PRO RUNNER 33"	CRAWLER XG 28"
5201 Accent	2883694	2883160	2883169					2883188
5201 Matte Black	2883693	2883159	2883168					2883187
5202 Accent	2883696	2883158	2883167	2885052	2885024	2885031	2885038	2883186
5202 Matte Black	2883695	2883157	2883166	2885053	2885025	2885032	2885039	2883185
5203 BEADLOCK Matte Black BEADLOCKS SOLD SEPARATELY	2883699	2883154	2883163	2885056	2885028	2885035	2885042	2883182
5204 Matte Black	2883700	2883155	2883164	2885058	2885030	2885037	2885044	2883183
5301 BEADLOCK Accent BEADLOCKS PRE-MOUNTED	2883698	2883162	2883171	2885054	2885026	2885033	2885040	2883190
5301 BEADLOCK Matte Black BEADLOCKS PRE-MOUNTED	2883697	2883161	2883170	2885055	2885027	2885034	2885041	2883189



60-SERIES

ROCK/RACE

	CRAWLER XG 32"
6301 BEADLOCK Accent BEADLOCKS PRE-MOUNTED	2883703
6301 BEADLOCK Matte Black BEADLOCKS PRE-MOUNTED	2883702

2 WAYS TO PURCHASE

INDIVIDUAL WHEELS & TIRES
- OR -
COMPLETE SETS AS LISTED

Exclusively at Polaris Authorized Dealers

⊙ LUG NUTS REQUIRED. SEE P. 62 FOR CAPS, BEADLOCK RINGS & LUG NUTS



- Extra deep treads
- Self-cleaning lugs



- Paddles provide traction and durability in soft sand
- Built to float on top of sand



- Triple-belted sidewalls to resist puncture
- Purpose-built, long lasting tread patterns



- Handles extreme cold
- Holds shape and provides traction

COMMON

DESERT/ROCK

SAND

CRAWLER XG 30"	CRAWLER XG 32"	CRAWLER XR 28"	SAND 12XT 30"
2882396	2882452	2882394	
2882397	2882451	2882395	
2881560	2882448	2881343	
2881561	2882447	2881344	
	2881382	2881386	
2881558	2882450	2881355	
2881559	2882449	2881356	2884034
2881564		2881371	
2881563	2882453	2881372	
2883211	2883215	2883213	
2883210	2883214	2883212	
2889555	2889556	2889554	
2889547	2889548	2889546	

PERFORMANCE

FRONT SWAY BAR KIT

» 2881205-458

XP TURBO '15-21, XP 4 TURBO '16-21, XP 4 1000 '16-22, XP 1000 '16-22
NOT COMPATIBLE WITH HIGH CLEARANCE A-ARMS

LIGHTING

CONNECTED TECHNOLOGY

AUDIO

WHEELS & TIRES

VEHICLE & RIDER PROTECTION

COOLERS

COCKPIT ACCESSORIES & MIRRORS

WINCHES

MISC. STV & YOUTH

CRAWLER XG 30"	CRAWLER XR 32"	CRAWLER XR 33"	NEW CRAWLER AT 30"	NEW CRAWLER AT 32"	15" 5101 Matte Black	SNOW WHITEOUT 30"	15" 5205 Matte Black	SAND SAND 16XT 30"	SAND 16XT 32"
2883179	2883194	2884744	2889510	2889518		2883172		2884035	2884036
2883178	2883193	2884736	2889511	2889519					
2883177	2883192	2884737	2889512	2889520					
2883176	2883191	2884738	2889513	2889521					
2883173	2882444	2884741	2889516	2889524					
2883174	2882445	2884743	2889517	2889525					
2883181	2883196	2884739	2889514	2889522					
2883180	2883195	2884740	2889515	2889523					

VALVES



COLBY SHORT ULTIMATE VALVE (2 PACK)

» 2883292



COLBY EMERGENCY VALVE (2 PACK)

» 2883293



COLBY COMBO VALVE KIT (16 PACK)

• Includes eight ultimate valves and eight emergency valves

» 2883294

TURBO S '18-21, XP TURBO '19-21, TURBO S 4 '20-21, XP 4 TURBO '19-21, XP 4 1000 '14-22, XP 1000 '14-22, S 900 '15-20, S 4 1000 '19-20, S 1000 '16-20, PRO XP '21-22, 900 '14-20

For off-road use only. Please check fitment with your dealer.

77



> VEHICLE & RIDER PROTECTION

WHEN PUSHING LIMITS

in punishing off-road environments, keep your RZR protected from harsh hits and damage with an added layer of protection and peace of mind.

HMW FRONT ARM GUARDS

- » 2880274
TRAIL S '21-22, TRAIL '21-22, S 900 '15-20, S 4 1000 '19-20, S 1000 '16-20, 900 '15-20
- » 2880170
900 '14-20
- » 2879454
XP TURBO '15-21, XP 4 TURBO '16-21, XP 4 1000 '14-22, XP 1000 '14-22

TOUGH .91 cm THICK
DESIGN WITHSTANDS THE
TOUGHEST IMPACTS

HMW SKID PLATE

- » 2-SEAT - 2880290
TRAIL S '21-22, TRAIL '21-22, S 900 '15-20, S 1000 '16-20, 900 '14-20
- » 2-SEAT - 2881615
XP TURBO '15-21, XP 1000 '14-22
- » 4-SEAT - 2881725
XP 4 TURBO '16-21, XP 4 1000 '14-22
TO FIT '14-15 ADAPTER BRACKET KIT, 2206329 IS REQUIRED

CUSTOM CONTOURED FOR
A PERFECT FIT TO **RETAIN**
MAXIMUM GROUND CLEARANCE

HMW REAR TRAILING ARM GUARDS

- » 2879496
XP 4 1000 '14-22, XP 1000 '14-22, XP 4 TURBO '16-21, XP TURBO '15-21, RS1 '18-22

HMW REAR GUARDS

- » 2880172
TRAIL '21-22, 900 '14-20



COMMON

LIGHTING

CONNECTED TECHNOLOGY

AUDIO

WHEELS & TIRES

VEHICLE & RIDER PROTECTION

COOLERS

COCKPIT ACCESSORIES & MIRRORS

WINCHES

MISC. STV & YOUTH



FULL COVERAGE FENDER FLARES

- Keep the mud, dirt and debris from launching off the tires and into your face
- Includes two, front only

» 2881985

TRAIL S '21-'22, TRAIL '21-'22, TURBO S '18-'21, TURBO S 4 '19-'21, XP TURBO '15-'21, XP 4 TURBO '16-'21, XP 1000 '14-'22, XP 4 1000 '14-'22, S 900 '15-'20, S 4 1000 '19-'20, S 1000 '16-'20, 900 '14-'20



MUD FLAPS

- Keeps the front wheels from flipping mud into the cab
- Rigid, injection-molded design to eliminate warping in high-heat conditions
- Designed to specifically integrate into front fender flares
- Includes two, front only

» 2879938

TURBO S '18-'21, TURBO S 4 '19-'21, XP TURBO '15-'21, XP 4 TURBO '16-'21, XP 1000 '14-'22, XP 4 1000 '14-'22, S 900 '15-'20, S 4 1000 '19-'20, S 1000 '16-'20, 900 '14-'20



152.4 cm STYLE FENDER FLARES

- Stock replacement for Trail S
- Includes four, front and rear

» 2879434

TRAIL S '21-'22, TRAIL '21-'22, 900 '14-'20



INTRUSION BAR

» 2879181

S 900 '15-'20, S 4 1000 '19-'20, S 1000 '16-'20, 900 '14-'20
NOT COMPATIBLE WITH FULL WINDSHIELDS
NOT COMPATIBLE WITH LED UNDER ROOF LIGHT BAR MOUNT (2881203, 2881553)

POLARIS
NORTHSTAR
COOLER

KEEP IT
ICE COLD



28, 57 & 99
LITER FEATURES



ComfortCarry
Handles



TravelLock
System



EasyOut
Drain System



NoSlip
Rubber Feet



PolarWall
Insulation



IceLock
Seal



99 LITER

- » GRAPHITE • 2883426
- » DESERT • 2883392



57 LITER







- » GRAPHITE • 2883425
- » DESERT • 2881259



28 LITER

- » GRAPHITE • 2883424
- » DESERT • 2881315

ESSENTIAL ACCESSORIES SO YOUR COOLER WORKS AS HARD AS YOU DO

COOLER ACCESSORIES		99 LITER	57 LITER	28 LITER
	WIRE BASKET	2883648	2882185	2882438
	DIVIDERS Doubles as cutting board	2883468 COMES WITH ONE DIVIDER  1 way to partition	2882184 COMES WITH TWO DIVIDERS  2 ways to partition	2882186 COMES WITH ONE DIVIDER  1 way to partition
	SEAT CUSHION	NOT AVAILABLE	2882179	2882507
	WHEELS	2883967	2882180	NOT AVAILABLE

GRIZZLY TESTED. POLARIS APPROVED.



This cooler is IGBC-approved, meaning it withstands the power expended by a typical grizzly bear if it was trying to get inside.

Seriously, there are experts who know what a grizzly is capable of doing, and they certify our coolers can take it.



POLARIS NORTHSTAR COOLERS CAN SURVIVE JUST ABOUT ANYTHING - FROM EXTREME HEAT TO A NASTY TUMBLE OFF A VEHICLE.



14 LITER

› GRAPHITE • 2883968



NEW
19 LITER SOFT-SIDED COOLER

› GRAPHITE • 2889285

DON'T FORGET THESE ACCESSORIES



887 mL

TUMBLERS

› 887 mL • 2883394
› 591 mL • 2883393



LOCK & RIDE
28 L COOLER
BRACKET

› 2884070
PRO XP 4 '20-'22, PRO XP '20-'22



BOTTLE
OPENER

› 2882183
ALL COOLERS

COMMON

LIGHTING

CONNECTED
TECHNOLOGY

AUDIO

WHEELS & TIRES

VEHICLE & RIDER
PROTECTION

COOLERS

COCKPIT ACCESSORIES
& MIRRORS

WINCHES

MISC. STD. & YOUTH

> COCKPIT ACCESSORIES



HARNESSES

Not available in Europe



CLICK-6 HARNESS TOP SELLER

- Racing-quality, premium construction for the greatest security and protection
- Six straps hold a driver securely in place in all riding conditions
- One-click, quick-release buckle releases straps, allowing easy egress
- Fully adjustable to fit riders of all sizes
- Easy to buckle and adjust, even while wearing helmet and gloves

DRIVER SIDE

» 2882244

TRAIL S '21-22, TRAIL '21-22,
TURBO S '18-21, XP TURBO '19-21,
TURBO S 4 '20-21, XP 4 TURBO '21,
XP 1000 '14-22, S 900 '15-20, S 4 1000 '20,
S 1000 '16-20, 900 '14-20

DOES NOT FIT 4-SEAT MODELS OR
HIGHLIFTER MODEL

» 2884075

PRO XP '20-22

» 2884077

PRO XP 4 '20-22

PASSENGER SIDE

» 2882245

TRAIL S '21-22, TRAIL '21-22,
TURBO S '18-21, XP TURBO '19-21,
TURBO S 4 '20-21, XP 4 TURBO '21,
XP 1000 '14-22, S 900 '15-20, S 4 1000 '20,
S 1000 '16-20, 900 '14-20

DOES NOT FIT 4-SEAT MODELS OR
HIGHLIFTER MODEL

» 2884076

PRO XP '20-22

» 2884078

PRO XP 4 '20-22

REAR PASSENGER

» 2884079

PRO XP 4 '20-22



RZR SUBZERO 4-PT HARNESS TOP SELLER

» DRIVER SIDE

2882281

TRAIL S '21-22, TRAIL '21-22, TURBO S '18-21,
XP TURBO '15-21, XP 1000 '14-22, TURBO S 4 '19-21,
XP 4 TURBO '15-21, XP 4 1000 '14-22, S 900 '15-20,
S 4 1000 '19-20, S 1000 '16-20, 900 '14-20,
PRO XP 4 '20-22, PRO XP 4 '20-22

» PASSENGER SIDE

2882282

TRAIL S '21-22, TRAIL '21-22, TURBO S '18-21,
XP TURBO '15-21, XP 1000 '14-22, TURBO S 4 '19-21,
XP 4 TURBO '15-21, XP 4 1000 '14-22, S 900 '15-20,
S 4 1000 '19-20, S 1000 '16-20, 900 '14-20,
PRO XP 4 '20-22, PRO XP '20-22

MIRRORS



NEW ADJUSTABLE FOLDING SIDE MIRRORS

- Left and right mirrors included
- Installs in minutes and integrates into a designated mounting position
- Laminated safety glass for excellent scratch resistance

» 2884524

TRAIL S '21-22, TRAIL '21-22, TURBO S '18-21, XP TURBO '19-21, XP 1000 '14-22, TURBO S 4 '20-21, XP 4 TURBO '19-21, XP 4 1000 '14-22, S 900 '15-20, S 4 1000 '19-20, S 1000 '16-20, 900 '14-20



PREMIUM CONVEX REARVIEW MIRROR TOP SELLER

- Installs in minutes and integrates into a designated mounting position
- Laminated safety glass for excellent scratch resistance

» 2883763

TRAIL S '21-22, TRAIL '21-22, PRO XP 4 '20-22, PRO XP '20-22



CONVEX DESIGN DELIVERS WIDE REAR VIEW

REARVIEW MIRROR TOP SELLER

- Works with all roofs, soft tops and windshields

» 2877945

TURBO S '18-21, XP TURBO '15-21, XP 1000 '14-22, TURBO S 4 '19-21, XP 4 TURBO '15-21, XP 4 1000 '14-22, S 900 '15-20, S 4 1000 '19-20, S 1000 '16-20, 900 '14-20



SCRATCH-RESISTANT GLASS MIRROR LENS

CONVEX REARVIEW MIRROR TOP SELLER

- Bolts into your choice of pre-designated mounting locations on the vehicle frame for easy install
- Convex design provides broad, expanded view of what's behind or alongside the vehicle

» 2881540

TURBO S '18-21, XP TURBO '15-21, XP 1000 '14-22, TURBO S 4 '19-21, XP 4 TURBO '15-21, XP 4 1000 '14-22, S 900 '15-20, S 4 1000 '19-20, S 1000 '16-20, 900 '14-20



QUICK GLANCE, WIDE-ANGLE VIEWING FOR MAXIMUM VISIBILITY

WIDE-ANGLE REARVIEW MIRROR

- Stamped steel frame and backing plate with large 6.4 cm x 35.6 cm convex mirror
- Up to 10° of range to adjust for rider height or view preference
- Easy over-structure installation with stamped steel mounts

» 2881199

TURBO S '18-21, XP TURBO '15-21, XP 1000 '14-22, TURBO S 4 '19-21, XP 4 TURBO '15-21, XP 4 1000 '14-22, S 900 '15-20, S 4 1000 '19-20, S 1000 '16-20, 900 '14-20

MISC

SEAT SLIDER

» 2879460

TURBO S '18-21, XP TURBO '15-21, XP 1000 '14-22, TURBO S 4 '19-21, XP 4 TURBO '15-21, XP 4 1000 '14-22, S 900 '15-20, S 4 1000 '19-20, S 1000 '16-20, 900 '14-20

SWITCH PANEL

- Adds five spaces for rocker switches without blocking storage

» 2881987

TURBO S '18-21, XP TURBO '15-21, XP 1000 '14-22, TURBO S 4 '19-21, XP 4 TURBO '15-21, XP 4 1000 '14-22, S 900 '15-20, S 4 1000 '19-20, S 1000 '16-20, 900 '14-20

COMMON

LIGHTING

CONNECTED TECHNOLOGY

AUDIO

WHEELS & TIRES

VEHICLE & RIDER PROTECTION

COOLERS

COCKPIT ACCESSORIES
BATTERIES

WINCHES

MISC, STV & YOUTH



> WINCHES

DEPENDABLE. TOUGH. BUILT FOR THE OFF-ROAD.

A Polaris Engineered winch is designed to help you get the job done right, get you on your way faster and prepare you for the unexpected.

WHY POLARIS?

Polaris off-road vehicles are engineered with designated mounting points and wiring for seamless install of Polaris Engineered winches.



TESTED **1,200+**
PULLS AT MAX LOAD



BUILT TO WITHSTAND
-29° C TEMPERATURES



**OPERATES FULLY
SUBMERGED**



**MILITARY
TESTED & APPROVED**

UPGRADE YOUR CONTROLS

WIRED REMOTE CONTROL

• Must order remote handle and socket together

» REMOTE HANDLE
4013466

» SOCKET
4017102

» SOCKET
4014228

WORKS WITH 2882240,
2883828, 2883825

WORKS WITH 2883825

WORKS WITH 2882240, 2883828

REPLACEMENT PARTS

1.5 M STEEL CABLE

1,588 kg SERIES
» 2878890

15 M SYNTHETIC ROPE

1,588 kg SERIES
» 2878888

2,041 kg SERIES
» 2879187

FEATURES & BENEFITS

ALL POLARIS ENGINEERED WINCHES COME WITH:

- ✓ INTEGRATED WIRING, MOUNT, PREASSEMBLED
- ✓ HOOK WITH STRAP
- ✓ CUT STEEL GEARS & SEALED DRIVETRAIN
- ✓ SEALED PERMANENT MAGNET MOTOR



Retrieve cable 5x as fast as standard mode on other Polaris winches. Get back to riding or complete your task quicker.

1. Set winch dial to N (Neutral) to manually pull the rope out and secure the hook to your anchor point
2. Set winch dial to L (Low) for maximum pulling power while winching your load
3. Set winch dial to H (High) for retrieving the rope 5x faster with Rapid Rope Recovery

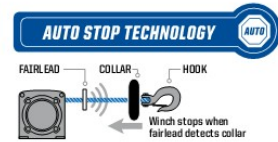

AUTO STOP TECHNOLOGY

Auto Stop technology protects and extends the life of your winch by automatically stopping the winch at the end of pull to prevent over-spooling. While plowing, it prevents the plow frame from bending by stopping the winch once the plow has been lifted.



PREMIUM SYNTHETIC ROPE

With its lightweight, yet extremely strong, design and superior flexibility, this 15 m long synthetic rope is easy to handle and can stand up to any tough job.



WIRELESS REMOTE

This convenient remote operates your Polaris winch wirelessly from within 15 m of the vehicle. Operate your winch safely outside your vehicle while on the job site or trails.

MODEL

TRAIL S '21-22
TRAIL '21-22

PRO XP 4 / PRO XP '20-22
Includes both wired and wireless remote

XP 1000 '14-22, **XP 4 1000** '14-22
XP TURBO '19-21, **XP 4 TURBO** '15-21
S 900 '15-20, **900** '14-20
S 4 1000 '19-20, **S 1000** '16-20

TURBO S 4 '19-21
TURBO S '18-21

RS1 '18-22

PRO PRO HEAVY DUTY SERIES

TOP-OF-THE-LINE FEATURES

BEST FOR PLOWING, HEAVY-DUTY OUTDOOR CHORES & TRAIL RIDING



HD HEAVY DUTY SERIES

BUILT FOR THE OFF-ROAD

BEST FOR THE CASUAL OFF-ROAD RIDER



PRO PRO HEAVY DUTY SERIES

HD HEAVY DUTY SERIES



NOT AVAILABLE



ADD AUTO STOP UPGRADE

2881693

SYNTHETIC ROPE REQUIRED



ADD SYNTHETIC ROPE

2878888



ADD WIRELESS REMOTE

2879316



2,721 kg	2,041 kg	1,588 kg	REQUIRED CABLES
	2885126	2885127	CABLES INCLUDED WITH WINCH WINCH COVER KIT REQUIRED 2884118
2883759	2883758		INCLUDED WITH WINCH
	TOP SELLER 2882240	TOP SELLER 2881671	2884118 TURBO S/4 '18-21, XP TURBO/4 '19-21, XP 1000/4 '19-22
	2883828		2881551 S 900 '16-20, S 1000 '16-20, 900 '15-20
	2883825		2881646 S 4 1000 '19-20
	EXTREME BUMPER (2883783-458) REQUIRED, SOLD SEPARATELY		INCLUDED WITH WINCH
			INCLUDED WITH WINCH

COMMON

LIGHTING

CONNECTED TECHNOLOGY

AUDIO

WHEELS & TIRES

VEHICLE & RIDER PROTECTION

COOLERS

COCKPIT ACCESSORIES & MIRRORS

WINCHES

MISC. STV & YOUTH

> ADDITIONAL ACCESSORIES

MISC

FIRE EXTINGUISHER MOUNT

» 2881200

TRAIL S '21-22, TRAIL '21-22, TURBO S '18-21, XP TURBO '15-21, XP 1000 '14-22, TURBO S 4 '19-21, XP 4 TURBO '15-21, XP 4 1000 '14-22, S 900 '15-20, S 4 1000 '19-20, S 1000 '16-20, 900 '14-20, PRO XP 4 '20-22, PRO XP '20-22



LOCK & RIDE

RZR WHIP FLAG & POLE

» FLAG & POLE • 2881468

» MOUNT • 2877502

TRAIL S '21-22, TRAIL '21-22, TURBO S '18-21, XP TURBO '15-21, XP 1000 '14-22, TURBO S 4 '19-21, XP 4 TURBO '15-21, XP 4 1000 '14-22, S 900 '15-20, S 4 1000 '19-20, S 1000 '16-20, 900 '14-20, PRO XP 4 '20-22, PRO XP '20-22



RIDE & REPAIR ESSENTIALS KIT

» 2881207

TRAIL S '21-22, TRAIL '21-22, TURBO S '18-21, XP TURBO '15-21, XP 1000 '14-22, TURBO S 4 '19-21, XP 4 TURBO '15-21, XP 4 1000 '14-22, S 900 '15-20, S 4 1000 '19-20, S 1000 '16-20, 900 '14-20, PRO XP 4 '20-22, PRO XP '20-22



PREMIUM FILTER KIT

TOP SELLER

- Polaris Ultraweb high performance air filter
- Provides superior engine protection with 99.99% efficiency
- Superior dust-holding capacity
- Lower restriction offers better performance for high horsepower, torque and acceleration

» 2882233

S 900 '15-20, S 4 1000 '19-20, S 1000 '16-20, 900 '14-20

» 2882234

TURBO S '18-21, XP TURBO '19-21, TURBO S 4 '20-21, XP 4 TURBO '19-21, XP 4 1000 '14-22, XP 1000 '14-22, PRO XP '21-22

570

LOCK & RIDE

SPORT ROOF

» BLACK • 2878748

570 '12-22

LOCK & RIDE

FULL WINDSHIELD - POLY

» 2879492

570 '12-22

HALF WINDSHIELD - POLY

» 2879493

570 '12-22

FRONT BUMPER

» 2878284

570 '12-22

POLARIS HD 1,588 kg WINCH

- All power cables included in the kit

» 2879334

570 '12-22

BUS BAR HARNESS REQUIRED, SOLD SEPARATELY

SEAT ADJUSTER KIT

» 2877390

570 '12-22

HORN KIT

» 2877788

570 '12-22

LOCK & RIDE

POLY REAR PANEL

» 2878752

570 '12-22

REAR BUMPER

» 2878697

570 '12-22

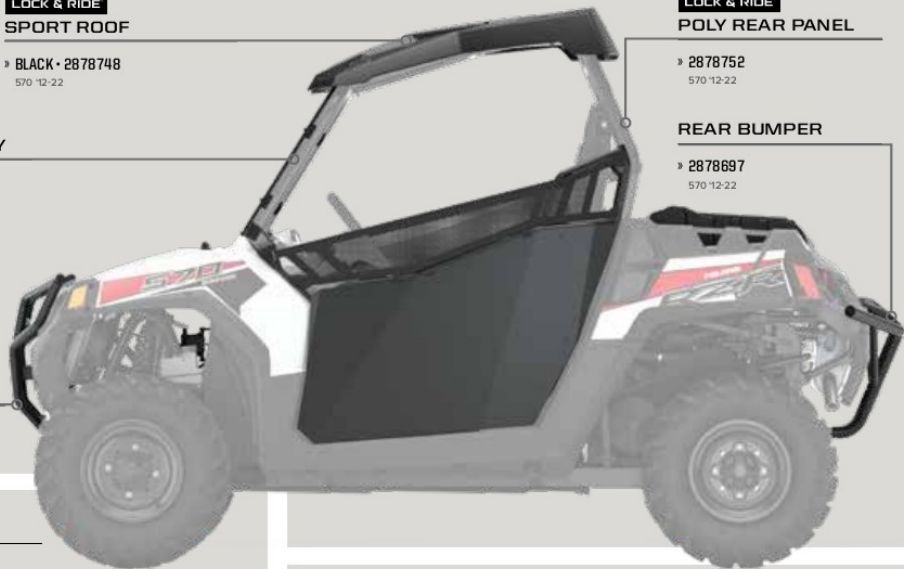

LOCK & RIDE CARGO BOX

- Holds and protects gear
- Attaches to the rear cargo bed in 10 seconds
- Rubber gasket seal to keep dirt and moisture out
- Lockable latches, heavy duty hinges, side handles

» 2876439-070

570 '12-22

> YOUTH



200 EFI

- COMMON
- LIGHTING
- CONNECTED TECHNOLOGY
- AUDIO
- WHEELS & TIRES
- VEHICLE & RIDER PROTECTION
- COOLERS
- COCKPIT ACCESSORIES & MIRRORS
- WINDSHIELDS
- MISC. 570 & YOUTH



NEW
LOCK & RIDE
FULL WINDSHIELD

- Made of durable polycarbonate to protect the cab from debris, dust, rain and wind
 - Lock & Ride offers easy, toolless installation
 - Integrates with the roof to prevent rain from entering the cab
- » 2884570



NEW
LOCK & RIDE
HALF WINDSHIELD

- Made of durable polycarbonate to protect the cab from debris, dust, rain and wind
 - Lock & Ride offers easy, toolless installation
 - Fully seals at the base for lower protection from the elements, while the open top-half enables airflow
- » 2884571



NEW
POLY ROOF FALL AVAILABILITY

- Durable HDPE material provides protection from the weather
 - 4-bolt installation
 - Integrates with full windshield to provide complete cab coverage
- » 2884572



NEW
BUMPERS

- Made of durable steel to provide great protection
 - Chassis integrated mounting
 - Front bumper offers integrated tow hook
- » FRONT • 2884577
» REAR • 2885144



NEW
ROCK SLIDERS

- Add durable protection from rocks, stumps or other debris with steel rock sliders
 - Chassis integrated mounting for easy install
 - Comes with two steel rock sliders
- » 2885146



NEW
REAR STORAGE BAG

- 3 L storage capacity
 - Mounts to rear ROPS with a Velcro wrap
 - Made to withstand the elements and wear with durable ballistic nylon construction
- » 2885145

NEW
PRO ARMOR YOUTH CRAWLER TIRE

- 25" design provides additional ground clearance
 - Improved performance in all types of applications, from rock crawling to desert running
 - Triple-belted sidewall for additional puncture-resistance
- » FRONT/REAR • 25" x 9.5" R12 • 5417953



NEW
PRO ARMOR YOUTH COMBAT WHEEL

- Designed specifically for youth vehicles
 - Increased strength and lightweight performance helps overcome obstacles on the trail
 - Compatible with stock lug nuts
- » FRONT • 12" x 7" • 1525222
» REAR • 12" x 7" • 1525223



NEW
PRO ARMOR WHEEL & TIRE SET: COMBAT & YOUTH CRAWLER

- Compatible with stock lug nuts
- » FOUR WHEELS & TIRES • 2889410



TREAD DEPTH	TIRE WEIGHT	PLY RATING	SIDEWALL BELTS	LOAD RATING
13mm	10.5 kgs	8	3	437 kgs

FOR THE LIFE OF YOUR RIDE

MAINTENANCE TIP

BREAK-IN PERIOD

The break-in period for your new RZR is the first 25 hours of operation, 1 month, or the time it takes to use the first two tanks of fuel (whichever comes first). No single action on your part is as important as a proper break-in period. Careful treatment of a new engine will result in more efficient performance and longer life for the engine.

NOTICE: Excessive heat build-up during the first three hours of operation will damage close-fitted engine parts. Do not operate at full throttle or high speeds for extended periods during the first three hours of use.

AIR FILTER

A clogged air filter can restrict air flow to the engine leading to reduced engine performance, engine life or catastrophic failure.

BRAKE PADS

Maintaining and/or replacing brakes are critical to the safety and functionality of a vehicle. Brake pads should be checked for wear and oil or grease (petroleum products) contamination and brake discs should be checked for cracks, excessive corrosion or warping.

HALF SHAFT

Check for tears and punctures in the boot, which can lead to CV joint wear that can contribute to axle failure.

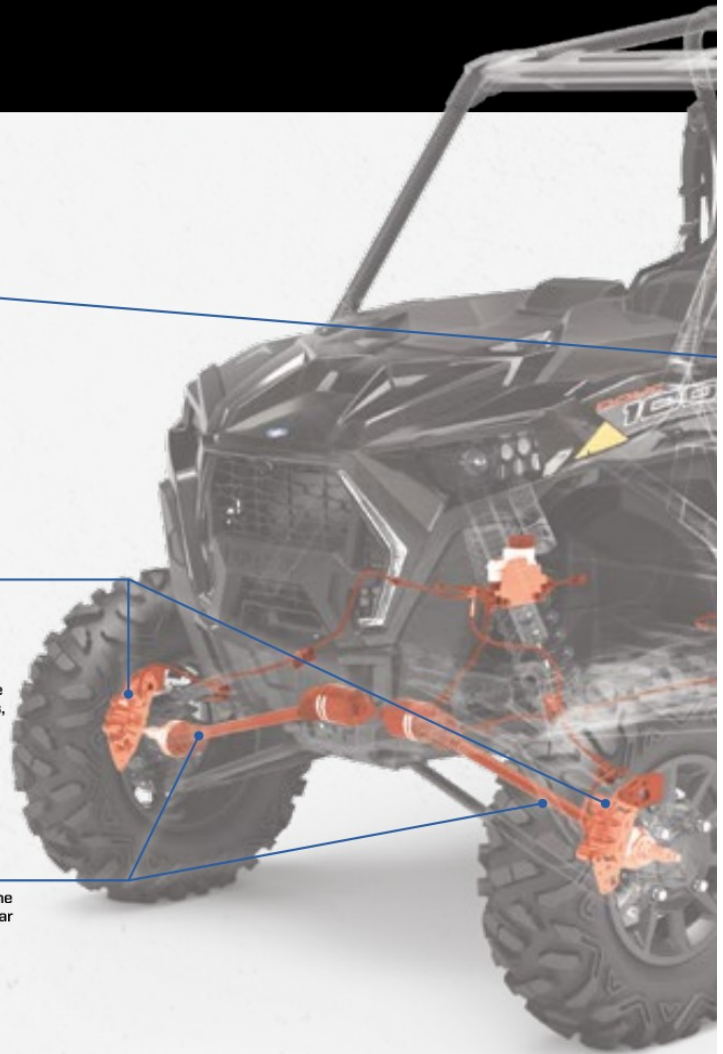

MAINTENANCE SCHEDULE

25 HRS / 400 km

BREAK-IN MAINTENANCE

- ENGINE OIL & OIL FILTER:**
CHANGE
- GENERAL LUBRICATION:**
ALL FITTINGS, PIVOTS, CABLES, ETC.
- AIR FILTER:**
INSPECT & REPLACE AS NEEDED
- EXHAUST SYSTEM:**
INSPECT & CLEAN
INSPECT FOR LEAKAGE OR CARBON BUILD UP AT JOINTS
INSPECT & CLEAN SCREEN TYPE SPARK ARRESTOR

50 HRS / 800 km

6 MONTHS

- EXHAUST SYSTEM:**
INSPECT & CLEAN
INSPECT FOR LEAKAGE OR CARBON BUILD UP AT JOINTS
INSPECT & CLEAN SCREEN TYPE SPARK ARRESTOR
- GENERAL LUBRICATION:**
ALL FITTINGS, PIVOTS, CABLES, ETC.
- DRIVE BELT:**
INSPECT & ADJUST
REPLACE AS NEEDED

100 HRS / 1,600 km

12 MONTHS

- ENGINE OIL & OIL FILTER:**
CHANGE
- DRIVE BELT:**
INSPECT & CLEAN
REPLACE AS NEEDED
- TRANSMISSION FLUID:**
CHANGE
- AIR FILTER:**
INSPECT & REPLACE AS NEEDED
- FRONT GEARCASE FLUID:**
CHANGE

150 HRS / 2,400 km

18 MONTHS

- ENGINE OIL & OIL FILTER:**
CHANGE
- BATTERY:**
TEST & CLEAN
REPLACE AS NEEDED
- DRIVE BELT:**
INSPECT & CLEAN
REPLACE AS NEEDED
- TIRES:**
INSPECT CONDITION & PRESSURE
- EXHAUST SYSTEM:**
INSPECT & CLEAN
INSPECT FOR LEAKAGE OR CARBON BUILD UP AT JOINTS
INSPECT & CLEAN SCREEN TYPE SPARK ARRESTOR

PARTS THAT PUSH THE LIMITS WITHOUT SACRIFICING STRENGTH AND DURABILITY.

We build our products so anyone with the right tools can maintain their vehicle.

POLARIS

ENGINEERED PARTS & LUBRICANTS

PARTS & GARAGE

MAINTENANCE

OIL & LUBRICANTS

HO PARTS

SERVICE PARTS

CLEANERS & TRAILERING

DRIVE BELT

Polaris Engineered belts deliver unmatched performance for your off-road vehicle. Developed and tested on all our engines for all environments and conditions. Check your belt for delamination, hour glassing and glazing.

BREAK-IN PERIOD

- Use lower gear (if available) while varying speeds and avoid wide open throttle for 8-16 km
- If no low gear is available, vary at moderate speeds while avoiding wide open throttle for 80 km

OUR INVESTMENT

- 32,187 km of field testing
- Thousands of dyno hours
- 18+ months of development (13,000+ design hours) per belt
- 1,500+ vehicle validation hours
- Collaboration with powertrain and clutch engineers

YOUR ADVANTAGE

- No clutch recalibration
- Less wear and tear due to heat
- Ensure maximum vehicle performance
- More time riding, less time wrenching
- Produced in collaboration with powertrain and clutch engineers to ensure a perfect fit, maximum performance and ultimate durability

OIL FILTER

Change oil filters with every oil change to provide the best engine protection and keep the engine operating at peak performance.

BATTERY

To ensure a battery maintains its level of charge when unused for extended periods of time or during freezing weather, the battery should be connected to a suitable battery charger. Be sure to check for corrosion from the terminals to the ends of the cables.

FOLLOW RECOMMENDED SERVICE INTERVALS IN THE OWNER'S MANUAL

200 HRS / 3,200 km

24 MONTHS

- ENGINE OIL & OIL FILTER:** CHANGE
- BRAKE PADS & FLUID:** REPLACE BRAKE FLUID
- SPARK PLUGS:** INSPECT
REPLACE AS NEEDED
- AIR FILTER:** INSPECT & REPLACE AS NEEDED
- EXHAUST SYSTEM:** INSPECT & CLEAN
INSPECT FOR LEAKAGE OR CARBON BUILD UP AT JOINTS
INSPECT & CLEAN SCREEN TYPE SPARK ARRESTOR

250 HRS / 4,023 km

30 MONTHS

- ENGINE OIL & OIL FILTER:** CHANGE
- BATTERY:** TEST & CLEAN
REPLACE AS NEEDED
- SHOCK ABSORBERS:** REPLACE & OIL SEALS
- DRIVE BELT:** INSPECT & CLEAN
REPLACE AS NEEDED
- GENERAL LUBRICATION:** ALL FITTINGS, PIVOTS, CABLES, ETC.
- EXHAUST SYSTEM:** INSPECT & CLEAN
INSPECT FOR LEAKAGE OR CARBON BUILD UP AT JOINTS
INSPECT & CLEAN SCREEN TYPE SPARK ARRESTOR

300 HRS / 4,828 km

36 MONTHS

- ENGINE OIL & OIL FILTER:** CHANGE
- AIR FILTER:** INSPECT & REPLACE AS NEEDED
- TRANSMISSION & FRONT GEARCASE:** REPLACE FLUIDS
- EXHAUST SYSTEM:** INSPECT & CLEAN
INSPECT FOR LEAKAGE OR CARBON BUILD UP AT JOINTS
INSPECT & CLEAN SCREEN TYPE SPARK ARRESTOR

CHECK YOUR OWNER'S MANUAL FOR ADDITIONAL RECOMMENDED SERVICE ITEMS AND VEHICLE-SPECIFIC TIMING

POLARIS

ENGINEERED PARTS & LUBRICANTS

FOR THE LIFE OF YOUR RIDE ONLY THE BEST WILL DO

To create the best oil for any terrain, we invest in rigorous testing to ensure our oil delivers the consistency and performance you demand. The results are Polaris Engineered Lubricants that are tested and perfected to deliver excellent total engine protection for the life of your ride.

WHAT COUNTS IN OIL TESTING:

1. Does it protect the engine at high temperatures?
2. Does it keep the engine free from carbon and buildup?
3. Does the oil hold its viscosity over time?

ENGINE CHECKPOINTS

When evaluating an engine oil and its ability to protect and preserve the engine's power output and lifespan, Polaris engineers focus on key areas within the engine, some of the most critical ones include:

RING LANDS: Poor oxidative performance can lead to carbon and varnish buildup, which results in poor ring seal and loss of power, combustion blow by and fuel dilution of the oil.

PISTON RINGS: During the combustion process, extreme pressures are placed on the top ring, forcing it outward toward the cylinder wall, sealing the combustion chamber. With so much force applied, poor oil film strength between the top ring and the cylinder wall can lead to cylinder wear and loss of power.

ROD BEARINGS: Engine bearings ride on an extremely thin hydrodynamic film of oil. Poor oil film strength or using an oil with a thinner viscosity, can lead to premature bearing wear or even engine failure. Using an oil with high film strength and a strong viscosity, like PS-4 full synthetic, will extend the service life of your engine.

CAMSHAFT: Direct Acting Overhead Camshafts are used on many Polaris Prostar Engines. In this application the camshaft pushes directly on the valve, creating very high contact pressures compared to other camshaft configurations. These forces are so great that inferior oil can break down and be forced out of the contact area leading to increased wear. PS-4 full synthetic additives are specifically designed to provide wear protection against this.

OIL DEVELOPMENT

**12 DEDICATED
TEAM MEMBERS**

**FOCUSED ON
POLARIS OIL**

**64,374
KILOMETERS**

**FIELD
TESTING**

**18+
MONTHS**

**DEVELOPMENT
& TESTING**

**75,000+
HOURS**

**DYNO
TESTING**



SPECIFIC NEEDS, SPECIFIC OILS

Polaris invests millions in engine development, and part of that investment is making sure its lubricants—critical to engine performance—are the right formula for your specific engine. The amount of testing data and engineering resources used in developing Polaris lubricants would overwhelm an aftermarket company. Therefore, the aftermarket must spec an oil to an industry-wide standard that must account for a variety of operating parameters.

PS-4 is designed specifically for Polaris 4-cycle engines and has high film strength and wear protection under extreme loads and temperatures. Exclusive anti-wear additives protect engine parts with extra rust and corrosion protection.

PS-4 SYNTHETIC PERFORMANCE OIL

• PS-4 is optimal for ambient operating temperatures of -40° C to 40° C

- › 1L • 502484
- › 4L • 502485
- › 25 L • 502486
- › 60 L • 502487
- › 200 L • 502488

PS-4 OIL CHANGE KIT

• Contains the correct amount of oil for your vehicle and correct oil filter

- › 502541
SINGLE 570, TWIN 600, TWIN 700, TWIN 800
- › 502543
RANGER/RZR 900/1000
- › 502542
330500, SPORTSMAN 550/850/1000

PS-4 EXTREME- DUTY SYNTHETIC PERFORMANCE OIL

• PS-4 Extreme Duty is optimal for ambient operating temperatures of -20° C to 55° C

- › 1L • 502491
- › 4L • 502492
- › 25 L • 502494
- › 60 L • 502496
- › 200 L • 502497

ENGINEERED TO MAXIMIZE THE LIFE OF YOUR RIDE

All Polaris fluids—from anti-freeze to brake fluid—are developed for your vehicle. Trust the only fluids perfectly engineered for your needs.

DOT 4 BRAKE FLUID

Polaris DOT 4 Brake Fluid is a high-quality brake fluid designed for use in Polaris hydraulic brakes. Superior high-temp characteristics plus anti-corrosive additives extend the life of brake system components and provide consistent, positive braking.

- › 250 mL • 502526

ANTI-FREEZE

Polaris Extended Life Coolant contains organic acid technologies to prevent corrosion on metal components, eliminate scaling, and maximize cooling system performance.

- › 1 L • 502566
- › 25 L • 502567
- › 206 L • 502568

AGL

A proprietary blend of additives designed to optimize Polaris' ORV transmission life. Extreme pressure additives protect gears, drive chain, and bearings from scoring and wear. Unlike typical gear case oils, AGL's unique viscosity range allows instant flow and film protection in extreme cold or high heat environments.

- › 1 L • 502505
- › 25 L • 502507
- › 200 L • 502508

DEMAND DRIVE FLUID

Engineered specifically for Polaris ORV front drive systems. Provides positive 4WD engagement in extreme cold or high heat conditions. Unique friction additives protect internal components under heavy loads and promote positive engagement.

- › 1 L • 502563
- › 25 L • 502564
- › 200 L • 502565

Proper lubricant application and timing will ensure optimal vehicle performance. Please refer to your owner's manual for lubricant change interval schedules.

CARBON CLEAN

Polaris Carbon Clean prevents ethanol corrosion, stabilizes fuel, and cleans fuel injectors, piston ring lands, intake systems, and combustion chambers. Helps maintain peak HP and improves fuel economy.

- › 125 mL • 502528

FUEL STABILIZER

Fuel Stabilizer prevents ethanol corrosion and stabilizes fuel for up to 2 years. Dual-antioxidant formula protects against gum and varnish for easy starting.

- › 125 mL • 502519

ANGLE DRIVE FLUID

- › 1 L • 502510
- › 25 L • 502511
- › 202 L • 502512

SPORTSMAN, RANGER, RZR ANGLE DRIVE GEAR CASE SYSTEMS

PREMIUM GAS SHOCK OIL

- › 1 L • 502518

ALL-SEASON GREASE TUBE

- › 400 g • 502538

HD HEAVY DUTY PARTS

All Polaris parts are developed and tested to help you get the most out of your ride. We're taking the passion of our riders, workers and outdoor enthusiasts to the next level with HD Parts.

Engineered and designed for:

- Greater durability
- Enhanced performance
- Greater wear and tear capabilities
- All weather conditions



NEW OIL FILTERS

The advanced synthetic material built into these filters offers the highest debris holding capacity, maintains oil flow and maximizes performance.

OE	HD HEAVY DUTY PARTS
2520799	2522485
2540086	2522498



NEW DRIVE BELTS

The enhanced rubber material compound in these belts keep them cool in extreme heat, while our patented cord treatment process maximizes the transfer of horsepower to the ground for those customers hauling heavy loads.

OE	HD HEAVY DUTY PARTS
3211148	3212326
3211113	3212328



WHEEL BEARINGS

Fully sealed for added protection against intrusions. Made of a higher grade steel for extended life in extreme conditions.

LOCATION	OE	HD HEAVY DUTY PARTS
FRONT WHEEL BEARINGS	3514924	3515090
REAR WHEEL BEARINGS	3414924	3515090



WHEELS & TIRES

Class leading durability for off-road performance and traction for confident driving in extreme conditions.

- » 1524022-458 • HD WHEEL - 14x7*
- » 5417507 • PRO ARMOR HD-K - 29x10R14*
- » 5457498-458 • HD WHEEL CENTER CAP*
- » 5415756 • PRO ARMOR XD-K FRONT
- » 5415757 • PRO ARMOR XD-K REAR

* SHOWN

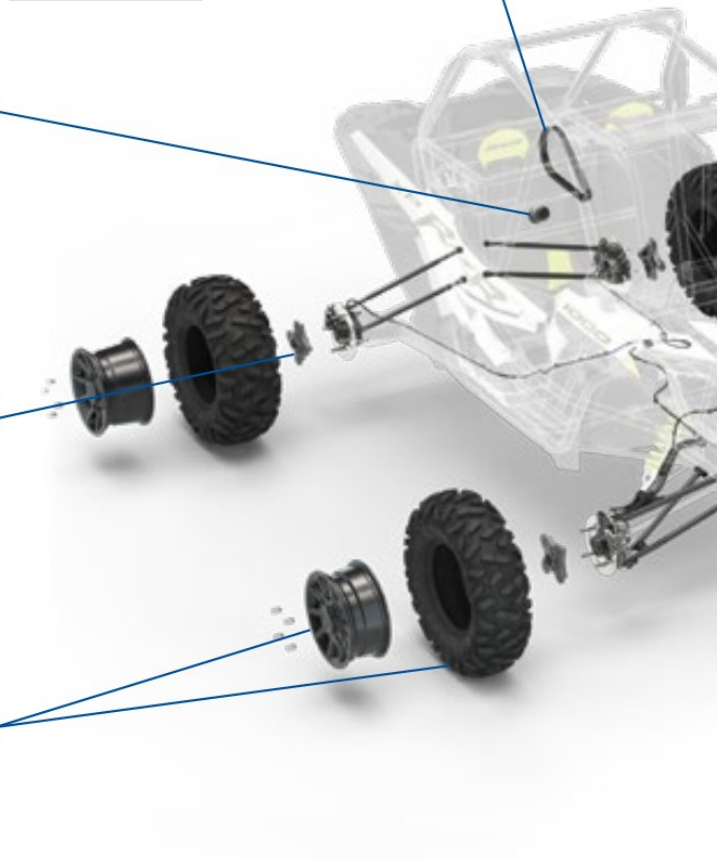

Claims made based off testing and performance of Polaris HD Parts against standard OEM parts made by Polaris and competitor brands under normal use.



BUSHINGS

The advanced material compound of the bushings enables tighter tolerances to reduce overall wear on the system, while the superior triple lip sealing prevents intrusion of the elements.

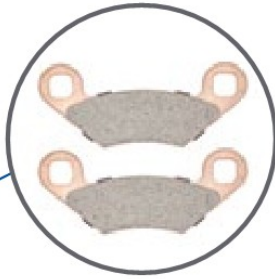
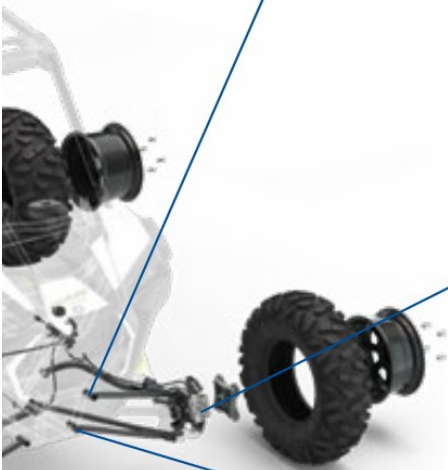

BRAKES

Engineered to provide longer life and better stopping power while riding in extreme conditions.

OE	HD HEAVY DUTY PARTS
2205949	2208933
2203318	2208936
2202413	2208934
2202412	2208935

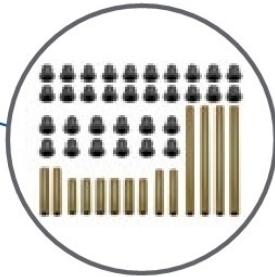

BUSHING KITS

Easily update the entire front and rear suspension.

» 2830564
RZR 800 '08-'14, RZR 800 S '09-'14



SAND



MUD



WATER



EXTREME COLD



EXTREME HEAT UP TO 54° C



HEAVY PAYLOADS



EXTENDED LIFE

PARTS & GARAGE

MAINTENANCE

OIL & LUBRICANTS

HD PARTS

SERVICE PARTS

CLEANERS & TRAILERING

For more information regarding Polaris HD parts including vehicle compatibility, installation and maintenance, please contact your authorized Polaris ORV dealer.

SERVICE PARTS

Polaris Engineered service parts deliver unmatched performance and fit for your off-road vehicle.

All service parts are engineered specifically for your machine. Which means everything is designed, tested and perfected to maximize the life of your ride. Getting Polaris Engineered parts is a decision that pays off in the long run, because it ensures there is a long run.



**VISIT YOUR POLARIS
DEALER TO SHOP FOR
SERVICE PARTS.**

**OVER
100,000
PARTS
AVAILABLE!**



FOR THE LIFE OF YOUR RIDE

Maintenance is the key to keeping your Polaris off-road vehicle performing at its peak. Items like belts, lubricants, and batteries represent only a few of these critical items engineered specifically by Polaris.



POLARIS ENGINEERED DRIVE BELTS

TESTED, PERFECTED

We test each belt on the intended vehicle – we don't just try to make an existing belt "just work".

– Amery Kuhl, Polaris CVT System Engineer

OUR INVESTMENT

- 32,187 km of field testing
- Thousands of dyno hours
- 18+ months of development (3,000+ design hours) per belt
- 1,200+ vehicle validation hours
- Collaboration with powertrain & clutch engineers

YOUR ADVANTAGE

- No clutch recalibration
- Less wear & tear due to heat
- Ensure maximum performance of your vehicle
- More time out riding, less time wrenching

**OUR INVESTMENTS ENSURE POLARIS BELTS
OUTPERFORM YOUR EXPECTATIONS.**

CV BOOT REPAIR KIT*

FIX ON THE GO | TEMPORARY COVERAGE

- A quick trail-side fix to increase trail time
- The flexible and durable boot material expands "over a cone tool for CV boot repairs, without disassembling CV axles
- Universal fit - works as a temporary fix for most powersports axles
- All components fit inside the cone, and a cover is provided for compact durable storage
- Easily fits in a cargo box, attached to the roll cage, in the glovebox or many other storage locations



Items shown are contained inside cone

UTV CV BOOT REPAIR KIT

Kit includes the following items:

- (1) Expandable XL CV Boot
- (1) Reusable Cone Tool
- (2) CV Boot Clamps
- (1) Tube of Silicone Lube
- (1) Grease Packet
- (1) Cone Cover

» 2830526

UTV TRAIL BOOT ONLY

» 2830527

ATV

» CV REPAIR KIT
2830528

» TRAIL BOOT ONLY
2830529

HOW TO INSTALL

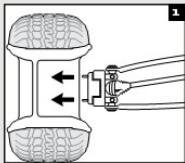

Remove wheel and axle nut.

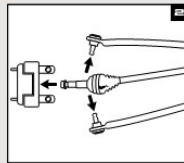

Remove brake caliper, hub, tie rod and upper and lower ball joints.

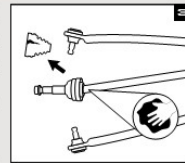

Remove old boot and clean joint.

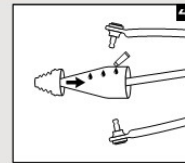

Spread silicone lube on entire cone tool. Slide boot over cone tool, large end first. See package for outer boot instructions.

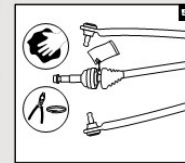

Empty the bag of grease into the CV joint/boot, clean sealing points and install clamps.

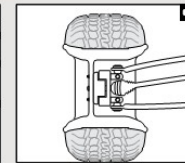

Reassemble tie rod, ball joints, brake caliper, axle nut, tire and wheel.

Refer to your service manual for further instructions and torque specifications.
*Designed for temporary CV boot repair. Purchase the OEM CV Boot for a permanent repair.

KEEP IT CLEAN

CLEAN

ALL-PURPOSE CLEANER

- Professional cleaner, which is formulated with a low pH-value. The product spreads well on surfaces and adheres on them for effective cleaning action. Perfectly compatible with rubber, plastic and painted surfaces. The formulation is biodegradable.

» 500 mL • 502309

SHINE

INSTANT SHINE & DETAILER

- The INSTANT SHINE AND DETAILER is developed for cleaning action without water. Removes insects, dust and dirt with almost no effort. Applicable for plastics, visors, windscreens, paint and metal. The wipe and shine formulation makes surfaces shine, works water repellent and also has an antistatic effect. Perfect for customers living in urban areas with no access to water, for bike trips or showroom bikes.

» 500 mL • 502303



BRING IT EVERYWHERE

TRAILERING



CALIBER RAMP PRO

- Designed for ATVs and UTVs up to 127 cm wide
 - Integrated grip glides for ultimate traction
 - Folding sides for easy transportation and storing
- » 132 cm x 229 cm • 2884576



ALUMINUM ARCHED LOADING RAMPS

- Capacity for up to 1,361 kg
- » 193 cm x 30.5 cm • 907 kg • 2875384
- » 224 cm x 30.5 cm • 1,361 kg • 2875386



LIGHTWEIGHT TRI-FOLD RAMPS

- Ramp folds up for transport
- Capacity for up to 681 kg
- Safety straps included
- » 183 cm x 130 cm • 2875385
- » 208 cm x 130 cm • 2875860

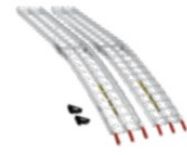

FOLDING ALUMINUM ARCHED RAMPS

- Ramp folds up for transport
- Up to 680 kg total capacity, 340 kg per individual ramp
- Safety straps included
- » 224 cm x 30.5 cm • 2875387

HITCHES

3:1 HITCHES

VERSATILE 3 IN 1 FUNCTIONALITY

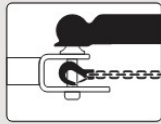

BALL

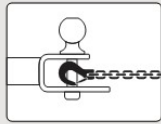

HOOK

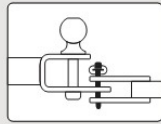

PIN

- Ball, hook and pin design
- Durable, rust resistant steel with black powdercoated finish
- Removable ball
- HD 1.6 cm pin and clip



HITCH WITH 5 cm BALL

- 5 cm x 5 cm RECEIVER 2830522
- 3 cm x 3 cm RECEIVER 2830523



4.8 cm BALL

- 4.8 cm replacement ball for hitch
- Designed to work with 3:1 Hitch
- » 2830524



RECEIVER HITCH

- 5 cm RECEIVER TONGUE 2875320



TRAILER BALL 1.9 cm SHANK

- 4.8 cm BALL • 2877602
- 5 cm BALL • 2877603

STRAPS & ROPES



RECOVERY STRAP

- 5 cm x 9 m
- 8,165 kg maximum load / 4,082 kg maximum vehicle weight
- Comes with carry bag
- » 2884033



SPARE TIRE RATCHETING Y-STRAP

- » 2689506



RATCHET STRAP

- 5 cm x 6.1 m Ratchet Straps
- Heavy duty webbing, floating D-rings, double J-hooks
- 4,536 kg maximum load, 1,497 kg working load
- » 2884032



RATCHET STRAP

- 3.8 cm x 4.6 m straps, 2-Pack
- Heavy duty webbing
- 2,495 kg maximum load, working load
- » 2884031



SHOCK STRAP

- 3.8 cm 1,361 kg breaking strength
- Keeps tension on tie-down straps to secure load
- 2-Pack
- » 3.8 cm x 4.6 m • 2883296



SHOCK STRAP

- 3.8 cm 1,361 kg breaking strength
- Keeps tension on tie-down straps to secure load
- 2-Pack
- » 3.8 cm x 2.1 m • 2883295

COVERS

TRAILERABLE COVER BY POLARIS

- 4-SEAT • 2883989
PRO XP 4 '20-'22
- 2-SEAT • 2885092
TRAIL S '21-'22, TRAIL '21-'22
- 2-SEAT • 2880325
900 '14-'20 [SHOW](#)
- 2-SEAT • 2876526
570 '12-'22
- 2-SEAT • 2883764
PRO XP '20-'22
- 2-SEAT • 2880327
S 900 '15-'20, S 1000 '16-'20, 900 '15-'20
- 2-SEAT • 2879373
XP TURBO '16-'21, XP 1000 '14-'22
- 4-SEAT • 2879949
XP 4 TURBO '16-'21, XP 4 1000 '14-'22
- 4-SEAT • 2880326
S 4 1000 '19-'21





TECHNICAL JACKET

- Water-resistant jacket
- Ultra-light thanks to polyester ripstop and softshell for optimal comfort
- Ventilated lining
- Hydration hose outlet
- Zip ventilation system on body and back

Black | S-3XL | 2802001



TECHNICAL PANTS

- Water-resistant pants
- Ultra-light thanks to polyester ripstop, softshell and 1000-D Cordura Stretch fabric on the back for optimal comfort
- 2 cargo type pockets
- Zip ventilation system
- Zip and Velcro adjustment at the bottom of the pants

Black | S-3XL | 2802002



NEW TECHNICAL SHIRT

- 100% polyester
- Indelible sublimated graphics
- Hemmed edging
- Lycra cuffs and collar

Black | S-3XL | 2802104



NEW BODYWARMER

- Upper body and side panels in softshell waterproof and breathable 3000mm/3000g
- Lower body Nylon downproof
- Padding 80 g
- Two external pockets with easy-grab puller

Black | S-3XL | 2802101



NEW SAFETY GLOVES TOUCH CE

- CE-approved motorcycle glove EN 13594:2015
- Touch screen compatible
- Silicon print on fingers to improve grip
- Neoprene cuff with Velcro tightening
- Reinforcement patches for safety and comfort

Black | XS-7,3XL-13 | 2802103



RACING SOFTSHELL

- Softshell waterproof and breathable 3000mm/3000g
- Removable hood
- Four external pockets with easy-grab puller

Black | S-3XL | 2802003



HYBRID JACKET

- Sleeves in softshell waterproof and breathable 3000mm/3000g
- Body nylon downproof
- Padding 80 g
- Three external pockets with easy-grab puller

Black | S-3XL | 2802004



RAIN JACKET

- Polyester ripstop high tearing resistance
- PU coating 1000 mm
- Mesh lining
- Non-removable hood

Black | S-3XL | 2802005



NEW SF TECH GLOVES TOUCH CE

- CE-approved motorcycle glove EN 13594:2015
- Touch screen compatible
- Knuckle-protected
- Silicon print on fingers to improve grip
- Neoprene cuff with Velcro tightening
- Reinforcement patches for safety and comfort

Black | XS-7, 3XL-13 | 2802102

> RIDING GEAR



NEW

OFF-ROAD RIDING JERSEYS

Mesh ventilated panels for maximum air flow
Elastic sleeves with non-restrictive cuffs

NEW

OFF-ROAD RIDING GLOVES

Adjustable wrist closure for a custom fit
Silicon finger grips and neoprene knuckle protection

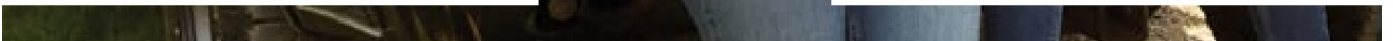

BLACK
JERSEY | S-3XL | 2862718
GLOVE | S-3XL | 2862726

ORANGE
JERSEY | S-3XL | 2862719
GLOVE | S-3XL | 2862729

TEAL
JERSEY | S-3XL | 2862720
GLOVE | S-3XL | 2862727

GREEN
JERSEY | S-3XL | 2862721
GLOVE | S-3XL | 2862730

BLUE
JERSEY | S-3XL | 2862722
GLOVE | S-3XL | 2862728

YOUTH JERSEY
S-XL | 2862723

YOUTH JERSEY
S-XL | 2862724

YOUTH JERSEY
S-XL | 2862725



SHORT SLEEVE

Men's | S-3XL | 2860634
Women's | S-3XL | 2860636

LONG SLEEVE

Men's | S-3XL | 2860638
Women's | S-3XL | 2860640



RAIN JACKET

Gray | S-3XL | 2869527

RAIN PANTS

Gray | S-3XL | 2869528

COOLING SHIRTS

FABRIC TECHNOLOGY DESIGNED TO KEEP YOU COOL

- Chemical-free fabric, Coolcore reduces the surface temperature up to 30% so you don't overheat
- Carries a 50 Ultraviolet Protection Factor rating, blocking 98% of harmful UV rays



RAIN JACKET & PANTS

PACKABLE WATERPROOF PROTECTION AGAINST UNPREDICTABLE WEATHER

- 100% waterproof, lightweight and packable nylon
- YKK zippers
- Rain jacket has removable hood

> HELMETS

FOR
POLARIS

NEW
TAN
XS-4XL
2862472



ALTITUDE

509 ALTITUDE 2.0 HELMET

LIGHTWEIGHT DESIGN, PERFORMANCE-INFUSED
STYLE AND FEATURES WITH ALL-DAY COMFORT

SHELL

- Strong, lightweight construction of carbon fiber or fiberglass

WEIGHT

- Composite as low as 1,260g
- Carbon fiber as low as 1,150g

FEATURES

- Superior fit for all-day comfort
- Removable Pro Series breath box provides excellent ventilation and air flow
- One-piece eyepoint creates draft-free seal with 509 goggles
- Magnetic Fidlock chin-strap technology and integrated GoPro mount
- DOT and ECE 22.05-approved

FIDLOCK.



BLACK
XS-4XL
2861469



BLACK/RED
XS-4XL
2861472



RED/BLACK
XS-4XL
2861470



CARBON FIBER
BLACK/LIME
XS-4XL | 2861473

FOR
POLARIS

RED/BLACK
XS-4XL
2862467



TACTICAL

NEW TACTICAL 2.0 HELMET

BUILT FROM THE GROUND UP WITH INNOVATIVE
FEATURES FOR ULTIMATE COMFORT AND CONTROL

SHELL

- Shock-resistant, injection-molded thermoplastic

FEATURES

- Venturi vent system generates negative pressure at velocity and pulls moist air from the breath box
- Integrated eyepoint seal is co-integrated with the breath box and creates a draft-free seal with 509 goggles for unparalleled warmth and clear field of view
- Magnetic Fidlock chin-strap technology
- DOT and ECE 22.06-approved

FIDLOCK.



MATTE BLACK
XS-4XL
2862468



GRAY
XS-4XL
2862469



LIME
XS-4XL
2862470



ORANGE
XS-4XL
2862471

TENACITY

TENACITY 4.0 HELMET

COMBINATION OF MODERN STYLE AND PREMIUM PROTECTION WITH INCREDIBLE VALUE

SHELL

- Shock-resistant, injection-molded thermoplastic

WEIGHT

- 1,500g

FEATURES

- Through-flow, full-helmet ventilation
- ProClip quick release chin strap allows you to fasten the chin strap in seconds
- Removable breath box
- Tool-less adjustable roost shield
- Removable, washable liner
- DOT- and ECE 22.05-approved

LIME
XS-2XL
2861559



BLACK
XS-2XL
2861557

BLACK/GRAY
XS-2XL
2861558

BLACK/WHITE
XS-2XL
2861560

WHITE/RED
XS-2XL
2861561

PINK
XS-2XL
2861562

GOGGLES



ORANGE
2862561

LIME
2862559

NEW

509 KINGPIN OFF-ROAD GOGGLE

PREMIUM MATERIALS, ATTRACTIVE PRICE



FEATURES

- Oversized spherical lens delivers optimal peripheral vision
- Metal tear-off posts provide strength and durability
- Quick-change technology allows you to run the best lens tint for conditions



BLUE
2862562

STEALTH
2862560

NEW

509 MX6 OFF-ROAD GOGGLE

SUPER WIDE FIELD OF VIEW, ENGINEERED FOR DIRT



FEATURES

- PC outer lens with anti-scratch coating, and internal anti-fog coating
- Outriggers with latch system for quick lens change
- 45mm strap with silicone to hold strap in place



BLACK
2862557

RED/BLACK
2862558

> MEN'S APPAREL

BLACK
S-3XL | 2862569

NEW
RED
S-3XL | 2862451



NAVY
S-3XL | 2862570



BLACK
S-3XL | 2861434



GRAY
S-3XL | 2861435

NEW
WORK VEST

RUGGED AND DURABLE VEST THAT'S IDEAL AS AN OUTDOOR LAYER

- Coated with Durable Water Repellency (DWR) to provide water-resistance
- 3M Thinsulate for added warmth with brushed flannel trim
- Three outer pockets for storage

SOFTSHELL JACKET

VERSATILE LIGHTWEIGHT JACKET THAT'S SURPRISINGLY WARM AND PERFECT FOR EVERYDAY WEAR

- Casual jacket armed with rugged and warm features for everyday wear
- Superior DWR prevents precipitation from saturating the jacket's exterior
- Lined with 280g of soft fleece for warmth
- Removable hood and underarm venting, three external pockets and one internal chest pocket



CHARCOAL
S-3XL | 2860865



BRONZE
S-3XL | 2860864



FOREST GREEN
S-3XL | 2860862



GRAY
S-3XL | 2860863



BLACK
S-3XL | 2861608

FLANNEL JACKET

SHERPA FLEECE LINED JACKET DELIVERS EXCEPTIONAL WARMTH AND COMFORT

- Warm sherpa lined fleece material
- Insulation to keep you warm
- Plenty of storage for your valuables

WORK JACKET

WARM AND RUGGED JACKET THAT'S TOUGH FOR WORK AND STYLISH FOR PLAY

- Coated with Durable Water Repellency (DWR) to provide water-resistance
- Built in action back for increased range of motion
- 80g 3M Thinsulate for added warmth with brushed flannel trim
- One inner and four outer pockets for storage

NEW
REVOLVE VEST

REVERSIBLE

**DURABLE AND WARM REVERSIBLE VEST
OFFERS TWO STYLES IN ONE**

- Durable windbreak outer fabric helps protect from the elements
- 140g 3M Thinsulate insulation keeps you warm in cold weather
- Reversible vest offers two unique styles in one



BLUE/ORANGE
S-3XL | 2862566

BLACK/GRAY
S-3XL | 2862565



NEW
WINDBREAKER JACKET

**LIGHTWEIGHT, WINDPROOF JACKET THAT
PROVIDES PROTECTION WHILE RIDING**

- 100% polyester windproof fabric
- Lightweight construction makes it easy to pack
- Three external pockets allow for maximum storage

Black | S-3XL | 2861541



FORCE JACKET

**PACKABLE JACKET OFFERS LIGHTWEIGHT
PROTECTION, IDEAL FOR ANY ACTIVITY**

- 140g 3M Thinsulate
- Plenty of storage with two external hand pockets and one internal media pocket
- Rugged YKK zippers
- Great for travel, compacts into pocket

Black | S-3XL | 2861432



APPAREL

RACING COLLECTION

RIDING GEAR

HELMETS & GOGGLES

MEN'S APPAREL

WOMEN'S APPAREL

MERCHANDISE

> MEN'S APPAREL

NEW

TITAN MID-LAYER

**EXTREMELY WARM YET BREATHABLE
MID-LAYER, PERFECT FOR RIDING**

- 319g Polartec Thermal Pro rib sweater provides great warmth
- Quick drying moisture wicking helps keep you dry
- Breathable material moves sweat to the outer surface
- Nylon overlay is comfortable and light

BLUE/ORANGE
S-3XL | 2862567



BLACK
S-3XL | 2862568



NEW
TAN
S-3XL | 2862450

RED/BLACK
S-3XL | 2862490



NORTHSTAR MID-LAYER

**VERSATILE MID-LAYER CAN BE WORN
ALONE OR AS AN EXTRA LAYER**

- 280g of breathable fleece for added warmth
- Offers durable protection against the elements with a wear-resistant polyester face and wind-block layer on chest
- Designed to fit under outer shell when riding

BLACK/RED
S-3XL | 2862616

BLACK/GRAY
S-3XL | 2869925

NEW

JOURNEY HOODIE

BLACK
S-3XL | 2862489

DURABLE HOODIE DESIGNED FOR EVERY DAY WEAR

- Keeps the elements out with snug, rib-knit waist and cuffs
- Mock neck collar provides added protection and warmth
- Durable blended material made of 80% cotton, 20% polyester



TECH FULL-ZIP HOODIE

■ **NEW** ■ Tan | S-3XL | 2862486
Gray | S-3XL | 2861493
Black/Blue | S-3XL | 2861494



CREW SWEATSHIRT

■ **NEW** ■ Black | S-3XL | 2862488
Green | S-3XL | 2861498
Navy | S-3XL | 2861497



ICON HOODIE

■ **NEW** ■ Gray | S-3XL | 2862487
Green | S-3XL | 2861495
Black | S-3XL | 2861496



ICON LONG SLEEVE

■ **NEW** ■ Gray/Red | S-3XL | 2862505
Black | S-3XL | 2861584
Blue | S-3XL | 2861585



DASH LONG SLEEVE

■ **NEW** ■ Gray | S-3XL | 2862504
Navy | S-3XL | 2861583
Black | S-3XL | 2861582



CHECKERED LONG SLEEVE

■ **NEW** ■ Red | S-3XL | 2862506
Gray | S-3XL | 2861587
Black | S-3XL | 2861586



ICON TEE

■ **NEW** ■ Green | S-3XL | 2862501
Black | S-3XL | 2861570
Blue | S-3XL | 2861571



STAMP TEE

■ **NEW** ■ Black | S-3XL | 2862496
Gray | S-3XL | 2861565
Green | S-3XL | 2861564



CORE TEE

■ **NEW** ■ Red | S-3XL | 2862502
Black | S-3XL | 2861572
Blue | S-3XL | 2861573

APPAREL

RACING COLLECTION

RIDING GEAR

HELMETS & GOGGLES

MEN'S APPAREL

WOMEN'S APPAREL

MERCHANDISE

> MEN'S APPAREL

RZR TECH HOODIE

Black/Red | S-3XL | 2861544
Gray/Blue | S-3XL | 2861545



RZR LONG SLEEVE

NEW Red | S-3XL | 2862508
Royal | S-3XL | 2861935
Black | S-3XL | 2861934

RZR TEE

NEW Gray | S-3XL | 2862509
Black/Red | S-3XL | 2861936
Royal | S-3XL | 2861937





**RZR
FULL ZIP HOODIE**
Charcoal Heather | S-3XL | 2860720
Black | S-3XL | 2860719



RZR LOGO HOODIE
Navy/Orange | S-3XL | 2869586
Gray/Lime | S-3XL | 2860704
Black/Red | S-3XL | 2869587



**RZR
VAPOR HOODIE**
NEW Black | S-3XL | 2862495
Gray | S-3XL | 2869593



RZR AIR TEE
Black | S-3XL | 2869591



NEW
RZR BOLT TEE
Navy | S-3XL | 2862510



RZR EDGE TEE
Gray | S-3XL | 2861940
Black | S-3XL | 2860729



NEW
RZR PRO CAP
Gray | One Size | 2862546



RZR PATCH HAT
Gray/Blue | S/M | 2861547
Gray/Blue | L/XL | 2861548
Black/Red | S/M | 2860607
Black/Red | L/XL | 2860608



RZR FLAT BILL
NEW Gray | One Size | 2862547
NEW Black | One Size | 2862596
Navy | One Size | 2861546

> MEN'S CAMO

STEALTH CAMO HAT

Camo | One Size | 2861527

NORTHSTAR MID LAYER

Camo | S-3XL | 2861542

CAMO SOFTSHELL JACKET

Camo | S-3XL | 2861543



NEW

CAMO REVOLVE VEST

Camo | S-3XL | 2862572



NEW

PURSUIT HOODIE

Camo | S-3XL | 2862494



CAMO NECK GAITER

Camo | One Size | 2861948



CAMO TRUCKER HAT

Black | One Size | 2860613



HUNTER ORANGE HAT

Orange | S/M | 2860892
Orange | L/XL | 2862545



HUNTER ORANGE BEANIE

Orange | One Size | 2862595

> MEN'S BALL CAPS



ELLIPSE PATCH TRUCKER HAT

NEW Light Gray | One Size | 2862539
 Gray | One Size | 2861531
 Black | One Size | 2861533
 Navy | One Size | 2861532

NEW HIGHLAND CAP

Tan | One Size | 2860893
 Gray | One Size | 2862544



CORE CAP

NEW Gray | One Size | 2862594
 Navy | One Size | 2861523
 Black | One Size | 2861524

TONAL HAT

Black/Red | One Size | 2861526
 Navy | One Size | 2861525

NEW CLASSIC CAP

Gray | One Size | 2862543
 Navy | One Size | 2862597



CHECKERED HAT

Blue | One Size | 2861520
 Black | One Size | 2861522
 Gray | One Size | 2861521

RETRO CAP

NEW Navy | One Size | 2862538
 Gray/Red | One Size | 2869542
 Gray/Orange | One Size | 2861536

APPAREL

RACING COLLECTION

RIDING GEAR

HELMETS & GOGGLES

MEN'S APPAREL

WOMEN'S APPAREL

MERCHANDISE

> WOMEN'S APPAREL

NEW

BLUE

S-3XL | 2862460

BLACK

S-3XL | 2862563



BLACK

S-3XL | 2861437

GRAY/BLUE

S-3XL | 2861439

BLUE

S-3XL | 2862564

SOFTSHELL JACKET

LIGHTWEIGHT PERFORMANCE THAT'S SURPRISINGLY WARM AND PERFECT FOR EVERYDAY WEAR

- Superior DWR prevents precipitation from saturating the jacket's exterior
- Lined with 280g of soft fleece for warmth
- Removable hood and underarm venting, three external pockets and one internal chest pocket

NEW

WORK JACKET

WARM AND RUGGED JACKET THAT'S TOUGH FOR WORK AND STYLISH FOR PLAY

- Coated with DWR to provide water-resistance
- Built-in action back for increased range of motion
- 80g 3M Thinsulate for added warmth with brushed flannel trim
- One inner and four outer pockets for storage



BLACK

S-3XL | 2862457

DUSTY ROSE

S-3XL | 2862456



BLACK

S-3XL | 2861433



BLACK/GRAY

S-3XL | 2862458

DUSTY ROSE

S-3XL | 2862459

NEW

REVOLVE VEST

DURABLE AND WARM REVERSIBLE VEST OFFERS TWO STYLES IN ONE

- Durable windbreak outer fabric protects you from the elements
- 140g 3M Thinsulate insulation keeps you warm in cold weather
- Reversible vest offers two unique styles in one

FORCE JACKET

PACKABLE JACKET OFFERS LIGHTWEIGHT PROTECTION, IDEAL FOR ANY ACTIVITY

- 140g 3M Thinsulate
- Plenty of storage with two external hand pockets and one internal media pocket
- Rugged YKK zippers
- Great for travel, compacts into pocket

TITAN MID-LAYER

EXTREMELY WARM YET BREATHABLE MID-LAYER, PERFECT FOR RIDING

- 319g Polartec Thermal Pro rib sweater provides great warmth
- Quick drying moisture wicking helps keep you dry
- Breathable material moves sweat to the outer surface
- Nylon overlay is comfortable and light



NEW
JOURNEY HOODIE
 Black | S-3XL | 2862515
 Blue | S-3XL | 2862516



TECH FULL-ZIP HOODIE
NEW Navy | S-3XL | 2862511
 Gray | S-3XL | 2861508
 Maroon | S-3XL | 2861509



ICON HOODIE
NEW White | S-3XL | 2862512
 Black | S-3XL | 2861506
 Maroon | S-3XL | 2861507



NEW
ADVENTURE CREW
 Dusty Rose | S-3XL | 2862513
 Black | S-3XL | 2862514



NEW
ADVENTURE TEE
 Teal | S-3XL | 2862629
 Black Frost | S-3XL | 2862628



THINK OUTSIDE TEE
NEW Pink | S-3XL | 2862518
 Black | S-3XL | 2861590
 Blue | S-3XL | 2861591



NEW
RZR LIGHTWEIGHT HOODIE
 Dusty Rose | S-3XL | 2862571
 Sage | S-3XL | 2862731



RZR TANK TOP
 Black | S-3XL | 2861945
 Gray | S-3XL | 2861944



RZR SCENIC TEE
 Gray | S-3XL | 2861943
 Maritime | S-3XL | 2860715
 Black | S-3XL | 2860714

> MERCHANDISE



STEEL SIGN

35.6 cm x 91.4 cm | 2860868



ALUMINUM SIGN

55.9 cm | 2860867



WOOD SIGN

26.7 cm x 61 cm | 2860866



PINT GLASSES (SET OF 2)

2860815



12oz CAMPER MUG

2861612



17oz WATER BOTTLE

2861611



NEW
23oz WATER BOTTLE

2862685



15oz CAMPFIRE MUG

2861613



KEYCHAIN

2861614



**LEATHER LOOP
KEYCHAIN**

2861615



NEW
**LICENSE PLATE
HOLDER**

2862687



NEW
KICKBACK ROCKER
2862626



NEW
FREESTYLE ROCKER
2862625



NEW
EASY CHAIR
2862627



NEW
QUICK-E-SEAT
2862624



NEW
FOLDING TABLE
2861620

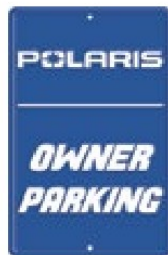

NEW
POLARIS PARKING
SIGN
2869934



NEW
POLARIS FLAG
91.4 cm x 152.4 cm | 2869928



NEW
HITCH COVER
2861623





MAKE IT YOUR RZR

DUNES

LIGHTING	P. 52
RZR SUBZERO 4-PT HARNESS	P. 82
PRO ARMOR WHEELS & TIRES	P. 62
ROOFS	P. 26
DOORS	P. 27

MUD

PRO ARMOR WHEELS & TIRES	P. 62
WINCH & MIRRORS	P. 18
DOORS	P. 13
ROOFS	P. 12
LIGHTING	P. 15
AUDIO	P. 08
STORAGE / COOLERS	P. 16



ROCK

PRO ARMOR WHEELS & TIRES	P. 62
VEHICLE PROTECTION	P. 28
WINCHES	P. 84
MIRRORS	P. 31
RIDE COMMAND	P. 58

Availability varies by market, check your local dealer for availability. Images taken on private land. The use of vehicles in similar environments in your jurisdiction may be prohibited per locally applicable laws and regulations. Campfires in similar environments in your jurisdiction may be prohibited per locally applicable laws and regulations. Keep your campfire safe, and make sure you can control it at all times. Know your locally applicable laws and regulations. Crossing water in similar environments may be prohibited in your jurisdiction.

Warning: Polaris off-road vehicles can be hazardous to operate and are not intended for on-road use. Driver must be at least 16 years old with a valid driver's license to operate. All riders should always wear helmets, eye protection and protective clothing and footwear. Read, understand and follow your owner's manual. Ride within the limits of your own abilities and never engage in stunt or exhibition driving. Never ride under the influence of drugs or alcohol. All riders should take a safety training course. Call 800 342-3764 for additional information.

UNLESS NOTED, TRADEMARKS ARE THE PROPERTY OF POLARIS INDUSTRIES INC. 3M® and Thinsulate® are registered trademarks of 3M Company. 509® is a registered trademark of Teton Outfitters, LLC. App Store® is a registered trademark of Apple Inc. BatteryMinder® is a registered trademark of VIC Electronics Inc. Bluetooth® is a registered trademark of Bluetooth Sig. Caliber® is a registered trademark of Caliber Products Inc. COOLCORE® is a registered trademark of COOLCORE LLC. CREE® is a registered trademark of Cree, Inc. Facebook® is a registered trademark of Facebook, Inc. FANG® is a registered trademark of CIRQ, LLC. Fidlock® is a registered trademark of Fidlock GmbH. Google Play® is a registered trademark of Google, Inc. GoPro® is a registered trademark of GoPro Inc. High Lifter® is a registered trademark of NIVEL PARTS & MANUFACTURING CO. Instagram® is a registered trademark of Instagram, LLC. KING OF THE HAMMERS® is a registered trademark of Hammering Productions, Inc. MB Quart® is a registered trademark of Maxsonics USA Inc. Pandora® is a registered trademark of Pandora Media, LLC. Polartec® is a registered trademark of MME:IPCO, LLC. Proline Wrap® are a registered trademark of Andrew Madrid. RIGID® is a trademark of JST Performance, LLC d/b/a Rigid Industries. Rockford Fosgate® is a registered trademark of Rockford Corporation. S&B® is a registered trademark of S&B Filters, Inc. SMART BOARD® is a registered trademark of MART TECHNOLOGIES ULC UNLIMITED LIABILITY CORPORATION CANADA. Sparco® is a registered trademark of Sparco S.P.A. TEKVEST® is a registered trademark of 1181576 ONTARIO INC. The Mint 400® is a registered trademark of THE MINT 400 CORPORATION. Tiger Drylac® is a registered trademark of TIGER COATINGS GMBH & CO. Twitter® is a registered trademark of Twitter, Inc. Velcro® is a registered trademark of VELCRO BYVA PRIVATE LLC BELGIUM. WALKER EVANS RACING® is a registered trademark of Walker Evans Enterprises Incorporated. Yeti® is a registered trademark of Yeti Coolers, LLC. YKK® is a registered trademark of YKK Corporation. YouTube® is a registered trademark of Google Inc. Prices, Fitment and Availability are subject to change at any moment. COPYRIGHT © 2021 POLARIS INDUSTRIES INC. ALL RIGHTS RESERVED.

RIDE OF YOUR LIFE



POLARIS

MY22 RZR APP ACC EMEA