

POLARIS **GENERAL**

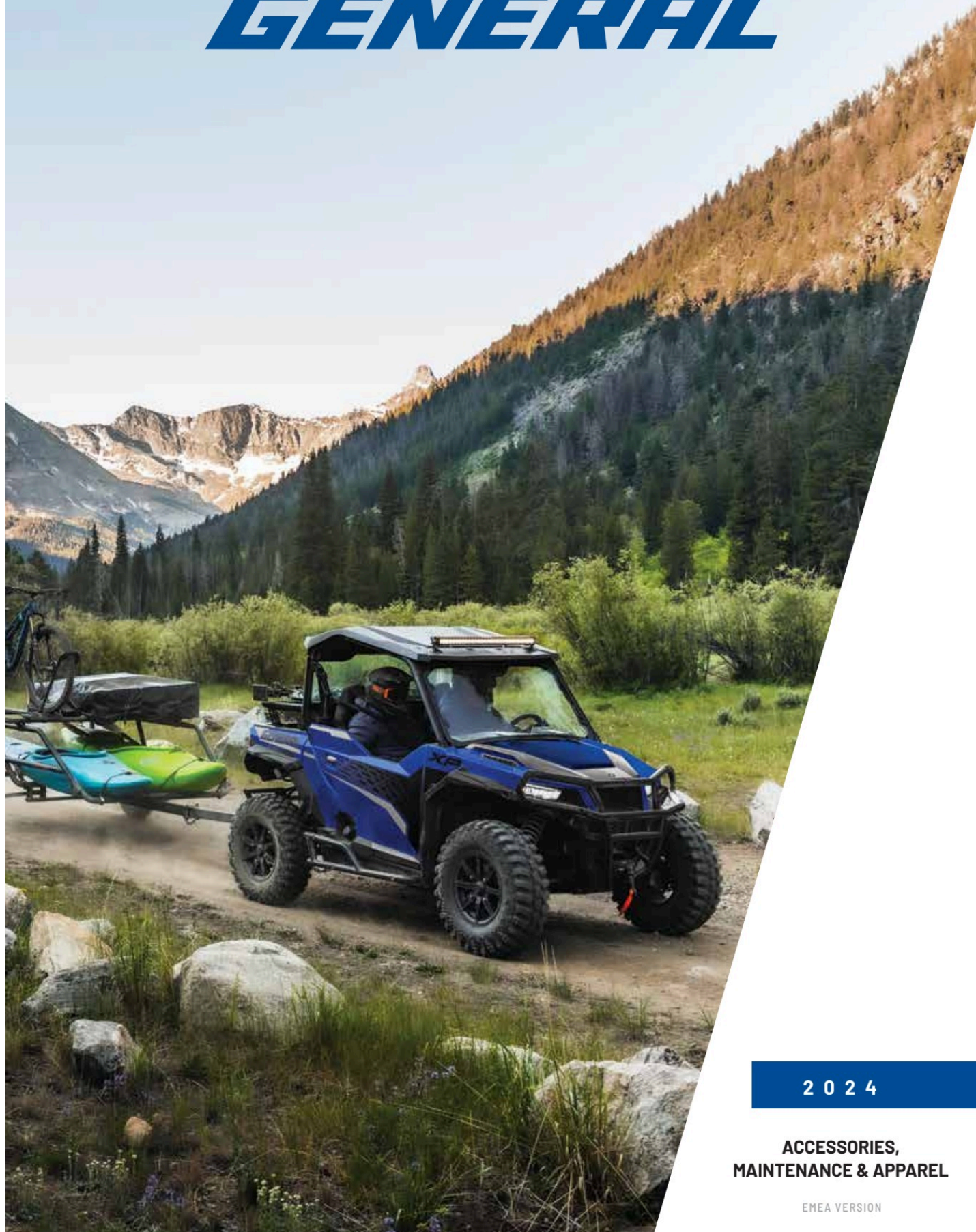

2024

**ACCESSORIES,
MAINTENANCE & APPAREL**

EMEA VERSION

UNLOCK MORE ADVENTURE

Off-road's premier family of adventure side-by-sides. No matter which GENERAL you choose, you begin every adventure with ultimate versatility for play and work, comfort for the long haul, and performance where it matters. When you customize with Polaris Engineered Accessories you have the confidence to take on any task or any trail.

**BRING IT ALL.
BRING IT ON.**

Industry-exclusive Rhino-Rack storage solutions for GENERAL. Transform your vehicle for work, play or anything in between with durable and easy-to-use bed racks and load securing attachments.

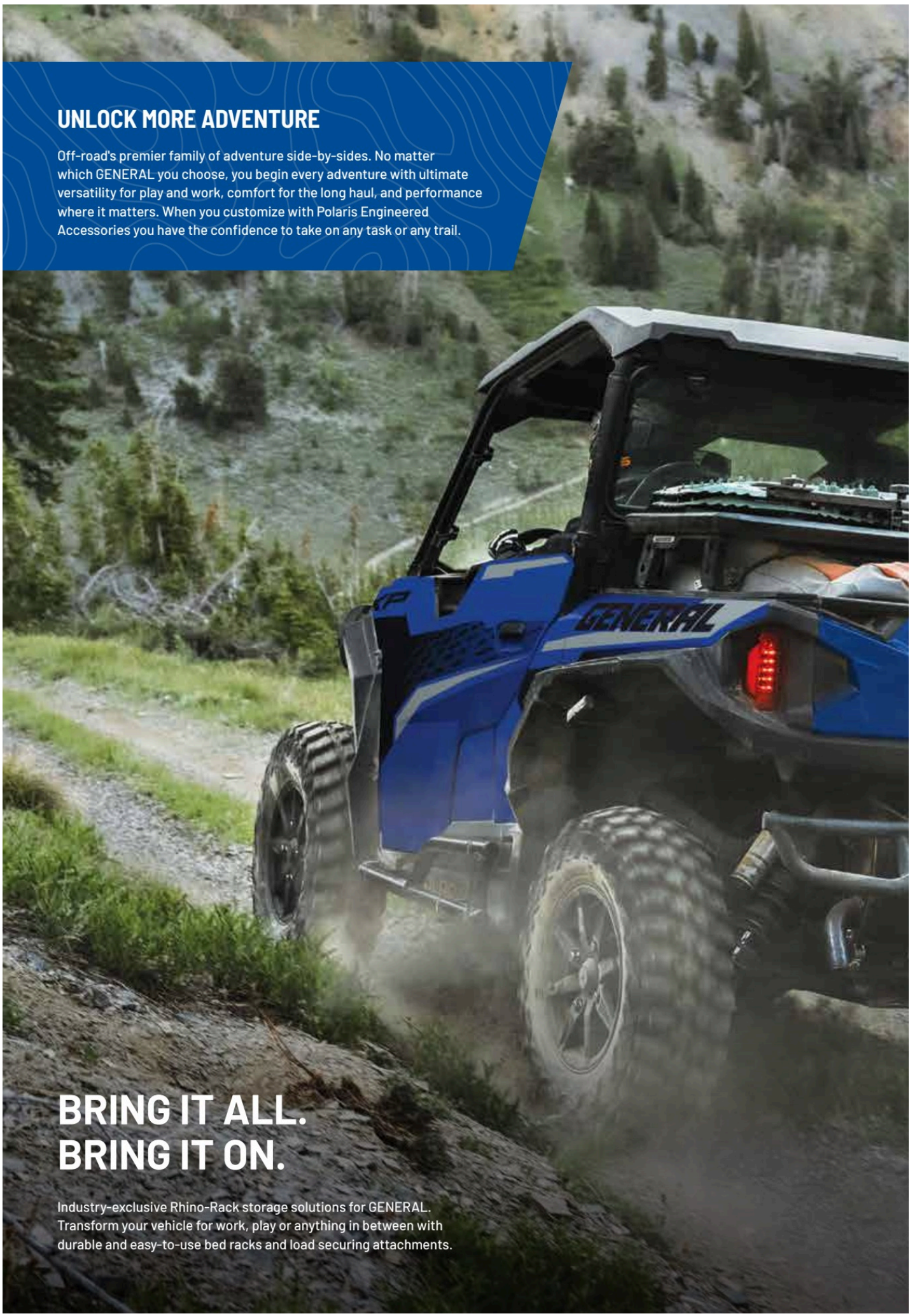

08 ACCESSORIES

- 12 WINDSHIELDS & REAR PANELS
- 14 DOORS
- 16 ROOFS
- 17 VEHICLE & RIDER PROTECTION
- 18 STORAGE
- 21 CAB COMFORT
- 22 HUNT
- 24 POLARIS NORTHSTAR COOLERS
- 26 CONNECTED TECHNOLOGY
- 28 AUDIO
- 30 LIGHTING
- 32 WHEELS & TIRES
- 40 WINCHES
- 41 PLOWS & TRACKS

42 MAINTENANCE & GARAGE

- 44 MAINTENANCE
- 46 OIL & LUBRICANTS
- 48 MAINTENANCE FLUIDS
- 50 HD PARTS
- 52 SERVICE PARTS
- 54 CLEANERS & TRAILERING

56 APPAREL

- 58 RACING COLLECTION
- 60 JERSEYS & GLOVES & HEATED APPAREL
- 62 HELMETS & GOGGLES
- 64 MEN'S APPAREL
- 68 BALL CAPS & BEANIES
- 70 WOMEN'S APPAREL
- 72 HOME & COLLECTIBLES

IMPORTANT: Adding accessories may impact the vehicle's conformity to its homologation or type approval. Polaris recommends consulting with local authorities and/or your local dealer to understand the requirements and restrictions related to the installation of accessories on your vehicle.

DESIGNED by the people who designed your vehicle.



TESTED extensively in the field so you ride with 100% confidence.



WE HOLD OUR PARTNERS TO THE SAME STANDARDS



WHEELS, TIRES & LIGHTING DESIGNED WITH POLARIS TO MAXIMIZE PERFORMANCE
P. 31, 32



A GLOBAL LEADER IN AUDIO INNOVATION, DESIGN & ENGINEERING
P. 28

KEEP YOUR STANDARDS HIGH. WE DO.

TRUSTED 65+ years in the business.
The #1 name in off-road.



RHINO-RACK

From opposite sides of the globe, some of the most capable machines in the off-road world meet a trusted outdoor adventure brand to deliver industry-exclusive Rhino-Rack® bed racks and accessories designed specifically for GENERAL. Perfectly integrated and tested to off-road standards, Rhino-Rack® storage solutions will help you get more storage capacity out of your GENERAL, so you can stay prepared for whatever the day may bring.

RIGID

PRODUCTS SO GOOD THEY REPLACE
OR REPAIR THEM FOR LIFE
P. 30

KOLPIN
OUTDOORS

PROTECTING YOUR
ESSENTIAL GEAR SINCE 1943
P. 22

 **RHINO-RACK**

BRING IT ALL.
BRING IT ON.
P. 18

ENGINEERED TO TAKE ON THE ELEMENTS

TESTED & PROVEN



DUST



WIND

BUILD YOUR CAB SYSTEM

STARTING ON P. 12



COMFORT YOU HAVE TO EXPERIENCE TO BELIEVE

Our cab components create an experience enhancing interior, offering supreme comfort to your vehicle.



PROFILE TUBE DESIGN

Contours built into the cage deliver a premium sealing surface.



PERFECT FIT, PERFECT SEAL

A 360° gasket seal provides our tightest-sealing cab.



EASY ON & OFF

Adapt to your needs and environment with exclusive toolless, easy on/off Lock & Ride components.

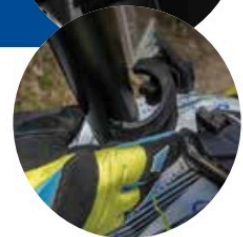

PLUG & PLAY ELECTRICAL

EFFORTLESSLY ADD LIGHTS, HEAT, WIPERS & AUDIO.

A revolution in electrical accessory integration, the Polaris PULSE Electrical System allows for a simple plug & play approach for adding power to Polaris Engineered Accessories.

Look for  to identify Polaris PULSE ready accessories.



UNLOCK

MORE ADVENTURE



 Vented Windshield - Hard Coat Poly: P. 12

Windshield Wiper & Washer System: P. 12

Rear Sport Bumper: P. 17

Extreme Kick-Out Rock Sliders: P. 17

Rhino-Rack Rear Bed Rack: P. 19

Polaris NorthStar 14 L Cooler: P. 25

Pro Armor 83 cm Combo LED Light Bar: P. 31

Light Bar Harness: P. 31

NAVIGATE THE TRAILS

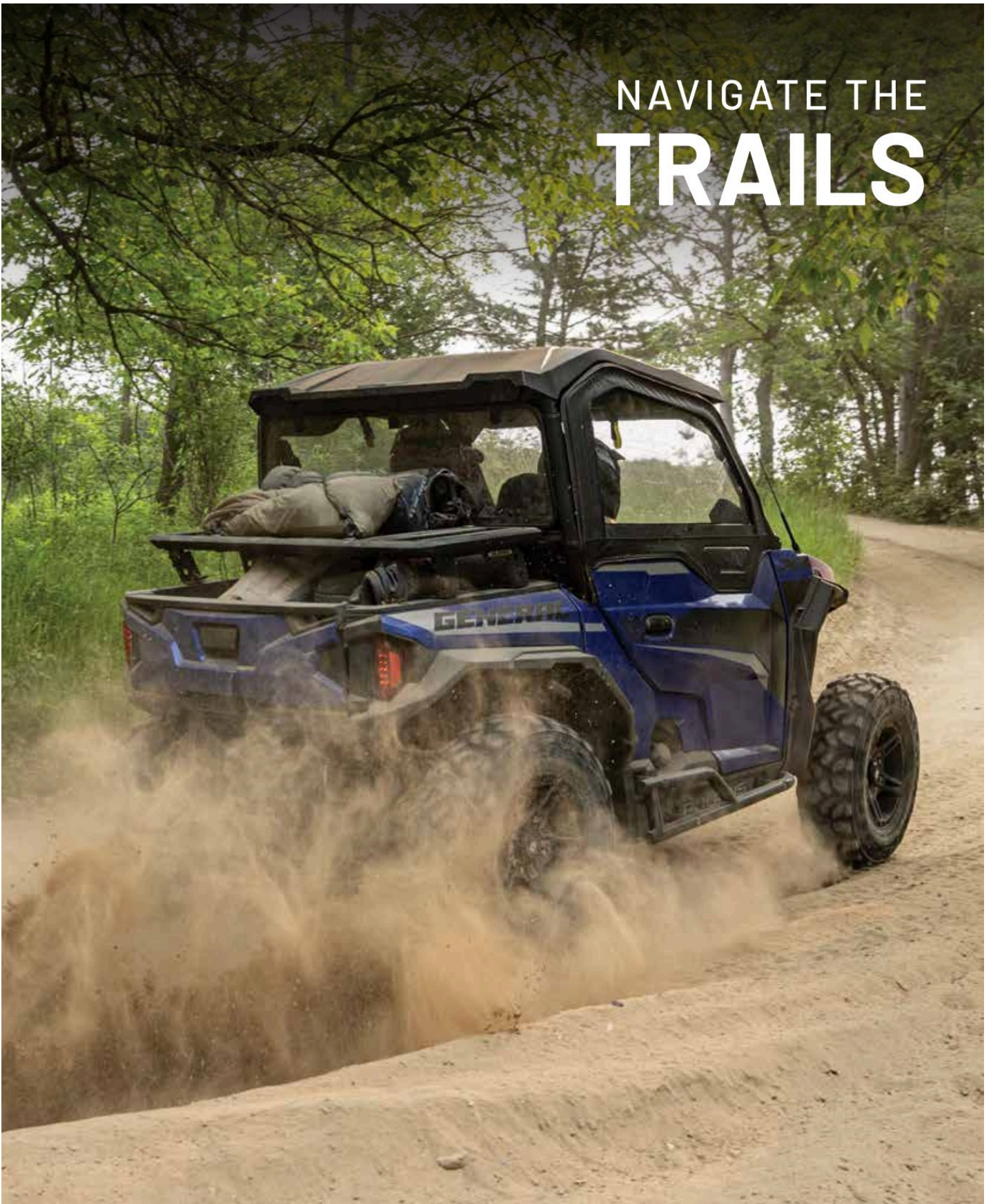

 Vented Windshield - Hard Coat Poly: P. 12

Sport Roof - Poly: P. 16

XL Fender Flares: P. 17 NOT SHOWN

 Cargo Box: P. 20

RIGID 32"81.3cm SR-Series Combo Light Bar: P. 31

Pro Armor Wheel & Tire Set

29" Mud XC & 14" 4204 - Matte Black: P. 39

Polaris Pro HD 2,041 kg Winch: P. 40

PREPARE FOR THE HUNT



 Full Windshield - Glass: P. 12 NOT SHOWN

Windshield Wiper & Washer System: P. 12 NOT SHOWN

 Rear Panel - Glass: P. 13

Polaris PULSE LED Light Bar Harness: P. 21 NOT SHOWN

Rear Adventure Rack: P. 23

Pro Armor 83 cm Combo LED Light Bar: P. 31 NOT SHOWN

In addition to stock accessories

SPORT

ESSENTIALS



 Full Windshield - Glass: P. 12

Windshield Wiper & Washer System: P. 12

 Rear Panel - Glass: P. 13

Premium Roof - Poly: P. 16

Polaris NorthStar 28 L Cooler: P. 24

WINDSHIELDS

Keep the elements out and control air flow into the cab.

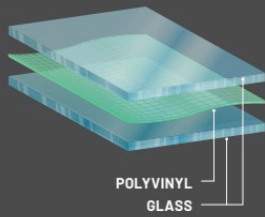

GLASS vs POLY

Superior optical clarity (automotive level)
Scratch-resistant
Curved to fit, seals tight
Cold weather / heavy duty
Wiper-ready

Lightweight, flexible, easy to store/remove
Impact-resistant
Tight seal keeps out rain and dust
Hard Coat: 30x more scratch resistance than regular poly

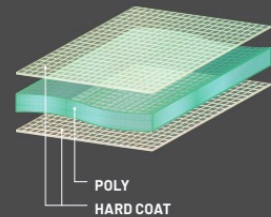

GLASS



TIP-OUT WINDSHIELD - GLASS TOP SELLER

» 2881108
GENERAL XP 1000/4 '20-24
GENERAL 1000/4 '16-24



FULL WINDSHIELD - GLASS TOP SELLER

» 2889064
GENERAL XP 1000/4 '20-24
GENERAL 1000/4 '16-24

HARD COAT POLY

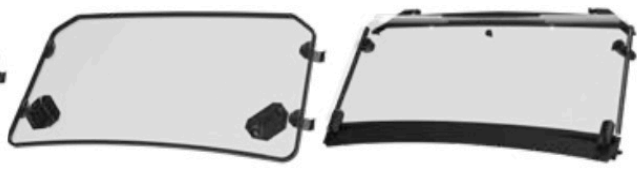

VENTED WINDSHIELD - HARD COAT POLY

» 2884223
GENERAL XP 1000/4 '20-24
GENERAL 1000/4 '16-24

FLIP-DOWN WINDSHIELD - HARD COAT POLY

» 2889156
GENERAL XP 1000/4 '20-24
GENERAL 1000/4 '16-24



WINDSHIELD WIPER & WASHER SYSTEM TOP SELLER

» 2881090
GENERAL XP 1000/4 '20-24
GENERAL 1000/4 '16-24



Integrated vents give you the ability to add extra airflow on hot summer days or defrost your windshield on the coldest winter mornings



Offers fully-sealed or flipped-down venting options. Upper half detaches, leaving lower half for protection with maximum ventilation.

REAR PANELS

Turbulent air forms above the cargo bed and behind the cab when you add a windshield. This swirl can carry dirt, dust, leaves, and rain into the cab. Eliminate this phenomenon and control the swirl by installing a rear panel.



ADD A REAR PANEL TO REDUCE
DUST SWIRL

**POLARIS ENGINEERED
ADVANTAGES**



**REVOLUTIONARY
INSTALLATION**



**AIRTIGHT
GASKET SEAL**

ACCESSORIES

WINDSHIELDS &
REAR PANELS

DOORS

ROOFS &
PROTECTION

STORAGE, CAB
COMFORT & HUNT

COOLERS

CONNECTED TECHNOLOGY
& AUDIO

LIGHTING

WHEELS & TIRES

WINCHES, PLOWS
& TRACKS

POLY

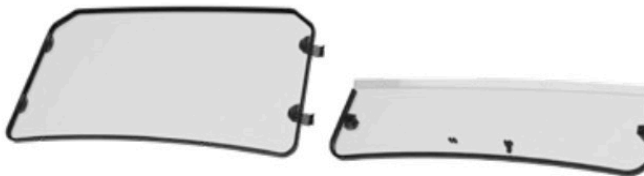

**FULL WINDSHIELD -
HARD COAT POLY**

» 2884337
GENERAL XP 1000/4 '20-24
GENERAL 1000/4 '16-24



**HALF WINDSHIELD -
POLY**

» 2881111
GENERAL XP 1000/4 '20-24
GENERAL 1000/4 '16-24

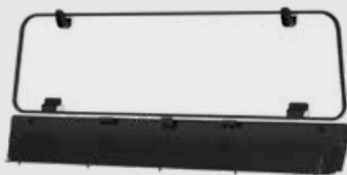

REAR PANEL - GLASS TOP SELLER

» 2881113
GENERAL XP 1000/4 '20-24
GENERAL 1000/4 '16-24



REAR PANEL - POLY TOP SELLER

» 2881112
GENERAL XP 1000/4 '20-24
GENERAL 1000/4 '16-24

DOORS

COMPLETE YOUR CAB. GENERAL comes equipped with half doors. To create an enclosed cab for increased protection from the elements, choose from two great Polaris options.



POLARIS ENGINEERED ADVANTAGES



PREMIUM INTERIOR HANDLE AND LINER



A PERFECT FIT FOR THE PERFECT SEAL



REPLACE STOCK HALF DOORS

PREMIUM POLY FULL DOORS

- Impact and scratch-resistant tempered glass
- Fully-sealed design keeps elements out for a premium in-cab environment
- Hinged window adjustability
- Soft-touch, easy-to-clean premium interior liner

A 2-SEAT

- Six-way glass window adjustability
- » 2889809
GENERAL XP 1000/4 '20-24
GENERAL 1000/4 '16-24

B 4-SEAT

- Push-out windows
 - Kit includes B-pillar cover seal
- » 2889810
GENERAL XP 4 1000 '20-24
GENERAL 4 1000 '17-24



ADD UPPER DOORS TO STOCK HALF DOORS

ZIP WINDOW UPPER DOORS

- Durable, rugged canvas stitched over a robust steel frame
- Lightweight, UV-resistant construction
- Retention straps for increased strength
- Zipper windows for increased venting options
- Mounts easily by drilling into stock doors (drill hole plugs included)

C 2-SEAT

» 2882548

GENERAL XP 1000 '20-24
GENERAL 1000 '18-24

NOT SHOWN

4-SEAT

» 2883453

GENERAL XP 4 1000 '20-24
GENERAL 4 1000 '18-24



**RHINO-RACK
STORAGE
SOLUTIONS**

SEE P. 18

ROOFS

Protect yourself from the elements. The right roof shields you from the sun and driving rain.

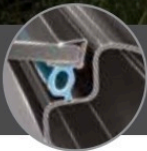

A PERFECT FIT FOR THE PERFECT SEAL

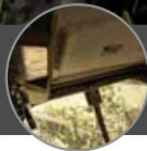

PREMIUM FEATURES & QUIETER RIDE



KEEP MOISTURE MOVING

POLARIS ENGINEERED ADVANTAGES

ALUMINUM vs POLY

2-SEAT

ROOF - ALUMINUM

» 2881105
GENERAL XP 1000 '20-24
GENERAL 1000 '16-24



High protection strength
Lower profile
Sleek style

Water run-off
Pre-existing mounting features
Liner ready
Lightweight

PREMIUM ROOF - POLY

» 2883800
GENERAL XP 1000 '20-24
GENERAL 1000 '16-24

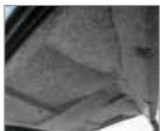

INCLUDES PREMIUM ROOF LINER

4-SEAT

PREMIUM ROOF - POLY

» 2883801
GENERAL XP 4 1000 '20-24
GENERAL 4 1000 '17-24

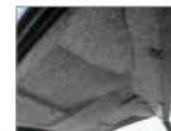

INCLUDES PREMIUM ROOF LINER

SPORT ROOF - POLY

» 2883780
GENERAL XP 1000 '20-24
GENERAL 1000 '16-24



SPORT ROOF - POLY

» 2883781
GENERAL XP 4 1000 '20-24
GENERAL 4 1000 '17-24

POLY ROOF LINER

» 2883802
GENERAL XP 4 1000 '20-24
GENERAL 4 1000 '17-24
Compatible with Sport Roof - Poly (2883781), sold separately



VEHICLE & RIDER PROTECTION

Arm your GENERAL with Polaris Engineered bumpers and guards to take on any challenge. Engineered for easy, secure installation; providing added protection for lights, bodywork and suspension.



EXPANSION ANCHOR MOUNTS

Tough expansion anchor mounts allow for quick install of rock sliders and bumpers without damaging the vehicle's frame.



UNEXPANDED



EXPANDED

FENDER FLARES / A-ARM GUARDS

A XL FENDER FLARES

» FRONT & REAR • 2884220

GENERAL 1000/4 '16-24
STANDARD ON GENERAL XP MODELS

Not compatible with Low Profile Rock Sliders

B HIGH CLEARANCE A-ARM GUARDS

» FRONT • 2884221

GENERAL XP 1000/4 '20-24

» REAR • 2884222

GENERAL XP 1000/4 '20-24

ROCK SLIDERS

C EXTREME KICK-OUT ROCK SLIDERS

• Compatible with XL Fender Flares

» 2-SEAT • 2881101

GENERAL XP 1000 '20-24
GENERAL 1000 '16-24

» 4-SEAT • 2881992

GENERAL XP 4 1000 '20-24
GENERAL 4 1000 '17-24

LOW PROFILE ROCK SLIDERS

» 2881102 [NOT SHOWN]

GENERAL 1000 '16-24

Not compatible with XL Fender Flares

SPORT BUMPERS

D SPORT LOW PROFILE FRONT BUMPER

» 2881094 TOP SELLER

GENERAL XP 1000/4 '20-24
GENERAL 1000/4 '16-24

E SPORT UPPER FRONT BUMPER

» 2881525

GENERAL XP 1000/4 '20-24
GENERAL 1000/4 '16-24

Requires Sport Low Profile Front Bumper
Not compatible with Front Hood Storage Rack (2889157)

SPORT REAR BUMPER

» 2884345 [NOT SHOWN]

GENERAL XP 1000/4 '20-24
GENERAL 1000/4 '16-24

ACCESSORIES

WINDSHIELDS & REAR PANELS

DOORS

ROOFS & PROTECTION

STORAGE, CAB COMFORT & HUNT

COOLERS

CONNECTED TECHNOLOGY & AUDIO

LIGHTING

WHEELS & TIRES

WINCHES, PLOWS & TRACKS

STORAGE



BRING IT ALL. BRING IT ON.

From opposite sides of the globe, some of the most capable machines in the off-road world meet a trusted outdoor adventure brand to deliver industry-exclusive, purpose-built roof racks, bed racks and attachments that help GENERAL riders get the most out of their next adventure.

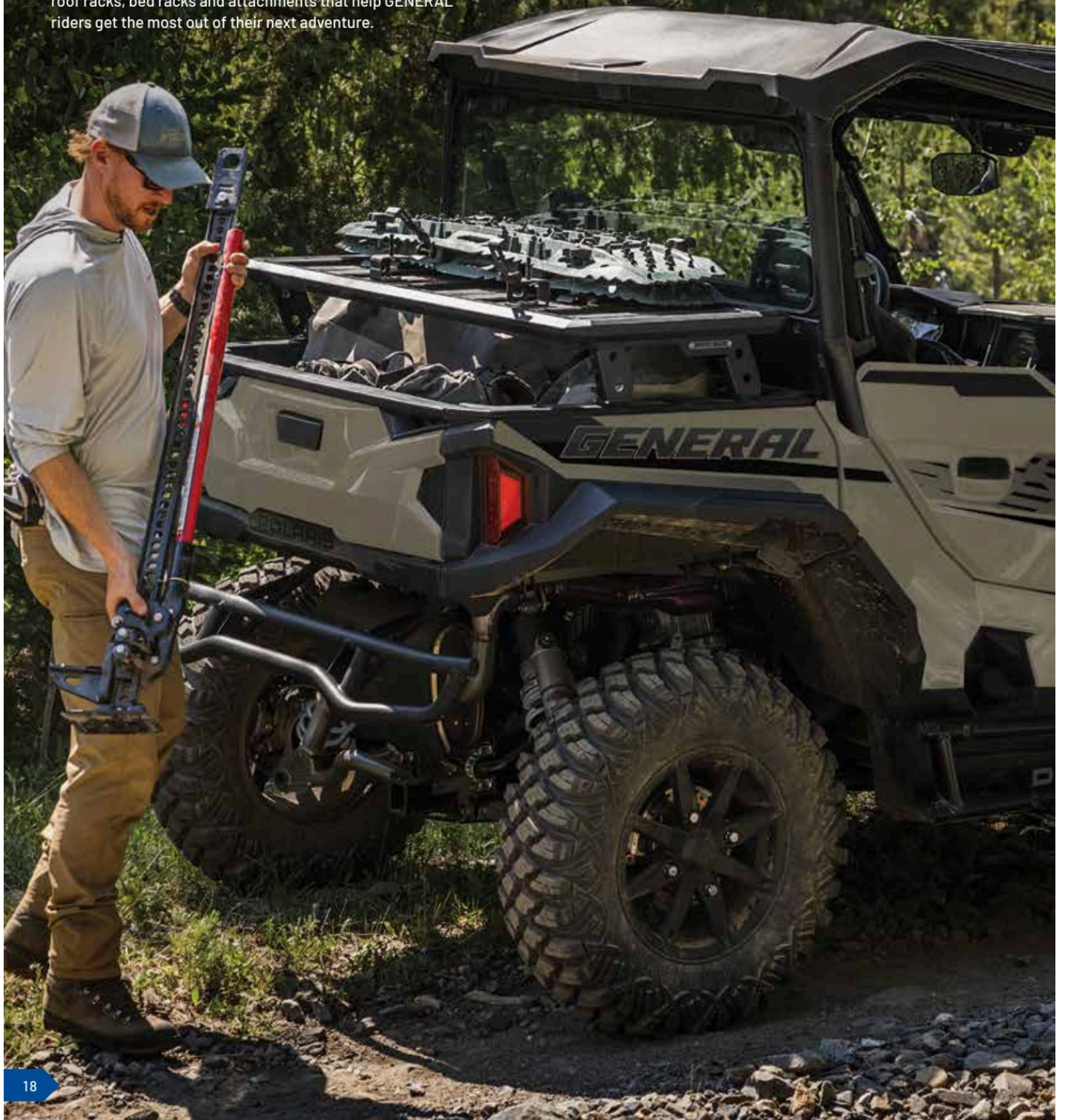



REAR BED RACK



REAR BED RACK

- The ultimate modular load carrying solution
- Strong, lightweight aluminum construction tested in the harshest conditions
- Quickly adapt your vehicle from workday to weekend with a wide array of Rhino-Rack attachments

» 2889443

GENERAL XP 1000/4 '20-24
GENERAL 1000/4 '16-24

ATTACHMENTS



GUN MOUNTING BRACKET

- Mount Kolpin Stronghold Gun Boots to Rhino-Rack systems when paired with Auto-Latch Mount (2884106), sold separately

» 2889327

GENERAL XP 1000/4 '20-24
GENERAL 1000/4 '16-24

See P. 22 for more hunt information

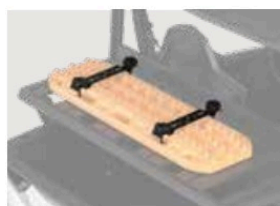

TRACTION BOARD MOUNT

- Strong, durable and easy to attach
- Traction boards sold separately

» 2889530

GENERAL XP 1000/4 '20-24
GENERAL 1000/4 '16-24



EYELET TIE-DOWNS

- Attach in multiple locations on the platform for additional tie-down points
- Anti-corrosive, galvanized steel for heavy duty strength
- Includes one set with hardware (straps not included)

» 2889527

GENERAL XP 1000/4 '20-24
GENERAL 1000/4 '16-24

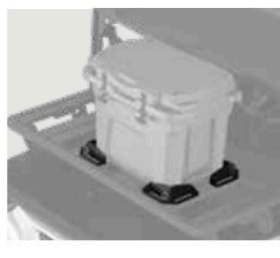

CARGO CORNER BRACKET

- Mount a NorthStar cooler or toolbox to the platform and save space inside the vehicle (straps not included)
- A unique, anti-rotation nut offers maximum security

» 2889531

GENERAL XP 1000/4 '20-24
GENERAL 1000/4 '16-24



MULTI-PURPOSE TOOL HOLDER

- Carry and protect tools, paddles and more
- Ratchet-locking mechanism for quick release and rubber inserts that secure gear into place

» 2889528

GENERAL XP 1000/4 '20-24
GENERAL 1000/4 '16-24



200L LUGGAGE BAG

- Carry bulky, lightweight gear in this tear- and weather-resistant canvas bag

» 2889881

GENERAL XP 1000/4 '20-24
GENERAL 1000/4 '16-24



HIGH LIFTING JACK MOUNT

- Simple, quick install with durable brackets
- Rugged, non-corrosive powder-coated steel stands up to the harshest conditions

» 2889533

GENERAL XP 1000/4 '20-24
GENERAL 1000/4 '16-24

STORAGE



A REAR ADVENTURE RACK
 • Mount is solid, does not fold
 » 2885113
 GENERAL XP 1000/4 '20-24
 GENERAL 1000/4 '16-24
 See P. 23 for more info

B KOLPIN STRONGHOLD MOUNT
 » 2885114
 GENERAL XP 1000/4 '20-24
 GENERAL 1000/4 '16-24
 See P. 23 for more info

C CARGO BED MAT
 » 2881933
 GENERAL XP 1000/4 '20-24
 GENERAL 1000/4 '16-24

D TIP-DOWN HEADACHE RACK
 » 2882144
 GENERAL XP 1000/4 '20-24
 GENERAL 1000/4 '16-24
 Not compatible with Kolpin Stronghold Mount (2885114)

E BED EXTENDER
 » 2881547
 GENERAL XP 1000/4 '20-24
 GENERAL 1000/4 '16-24
 Not compatible with Kolpin Stronghold Mount (2885114)

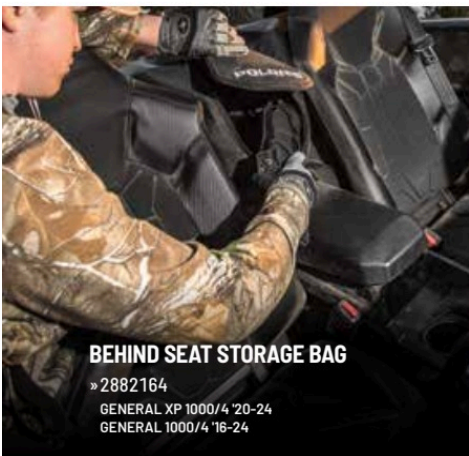

BEHIND SEAT STORAGE BAG
 » 2882164
 GENERAL XP 1000/4 '20-24
 GENERAL 1000/4 '16-24



IN-DASH STORAGE BAG
 » 2882165
 GENERAL XP 1000/4 '20-24
 GENERAL 1000/4 '16-24



FRONT HOOD RACK
 » 2889157
 GENERAL XP 1000/4 '20-24
 GENERAL 1000/4 '16-24



EASILY RECONFIGURE FOR ANY TASK OR ANY TRAIL

F CARGO BOX
 » 2881527
 GENERAL XP 1000/4 '20-24
 GENERAL 1000/4 '16-24
 Includes all mounting hardware for secure installation

D-RINGS TOP SELLER
 » 2881545
 GENERAL XP 1000/4 '20-24
 GENERAL 1000/4 '16-24



FIRE EXTINGUISHER HOLDER
 » 2882158
 GENERAL XP 1000/4 '20-24
 GENERAL 1000/4 '16-24
 Fits most 8.25 cm fire extinguishers (not included)



CAB COMFORT

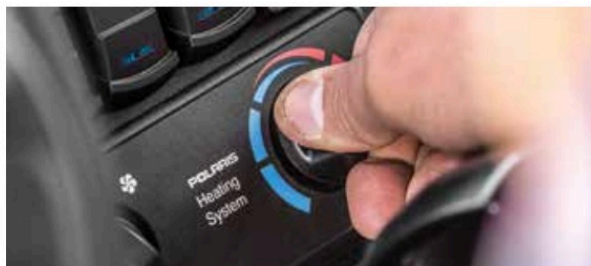

TOP SELLER
8-VENT HEATER AND DEFROST SYSTEM

» 2881316
 GENERAL XP 1000/4 '20-24
 GENERAL 1000/4 '16-24
 Not Compatible with Rockford Fosgate Stage 4 Audio Kits
 Audio Bracket (2885112) required to install heater on vehicles with RIDE COMMAND and audio, sold separately



TOP SELLER
WINDSHIELD WIPER AND WASHER SYSTEM

» 2881090
 GENERAL XP 1000/4 '20-24
 GENERAL 1000/4 '16-24

SEE P. 12 FOR WINDSHIELDS



CONVEX REAR VIEW MIRROR

» 2881540
 GENERAL XP 1000/4 '20-24
 GENERAL 1000/4 '16-24



NEW
SIDE VIEW MIRRORS

- Mounts on any vehicle that is equipped with doors
- Fully adjustable and can fold in to prevent being struck

» 2889243
 GENERAL XP 1000/4 '20-24
 GENERAL 1000/4 '16-24

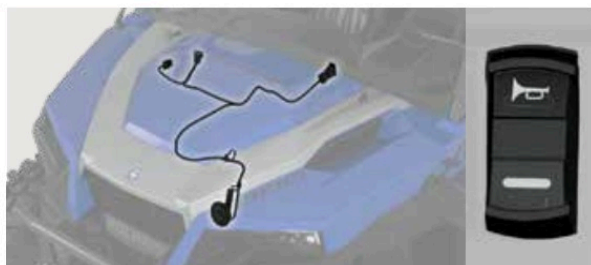

NEW
HORN KIT

» 2890589
 GENERAL XP 1000/4 '20-24
 GENERAL 1000/4 '16-24



FLOOR MATS

» 2881934
 GENERAL XP 1000/4 '20-24
 GENERAL 1000/4 '16-24



MULTI-FUNCTION CAB LIGHT

- LED dome light provides white, red, green and blue lighting options
- Removable to use as flashlight, battery-operated, recharges when vehicle is on

» 2884047
 GENERAL XP 1000/4 '20-24
 GENERAL 1000/4 '19-24

ELECTRICAL INSTALLS MADE EASY WITH
PLUG & PLAY

- To install accessories, simply plug the harness into the Polaris PULSE bar
- No need to remove nuts and stack wire terminals like a three-post terminal setup
- By plugging in your accessories, a secure connection is guaranteed every time

TOP SELLER
POLARIS PULSE LED LIGHT BAR HARNESS

- Required to easily add electric components

» 2883785
 GENERAL XP 1000/4 '20-24
 GENERAL 1000/4 '19-24

HUNT



KOLPIN
OUTDOORS

**PROTECTING YOUR
ESSENTIAL GEAR SINCE 1943**

KOLPIN STRONGHOLD CASES & MOUNTS



KOLPIN STRONGHOLD GUN BOOT XL TOP SELLER

- Includes zippered internal liner
 - Lockable
- » 2882036
GENERAL XP 1000/4 '20-24
GENERAL 1000/4 '16-24
Auto-Latch Mount (2883970 or
2884106) required, sold separately



KOLPIN STRONGHOLD GUN BOOT L TOP SELLER

- » 2882426
GENERAL XP 1000/4 '20-24
GENERAL 1000/4 '16-24
Auto-Latch Mount (2883970 or
2884106) required, sold separately



KOLPIN STRONGHOLD AUTO-LATCH MOUNT

- » 2884106
GENERAL XP 1000/4 '20-24
GENERAL 1000/4 '16-24



KOLPIN STRONGHOLD AUTO-LATCH DOUBLE GUN BOOT MOUNT

- » 2883970
GENERAL XP 1000/4 '20-24
GENERAL 1000/4 '16-24



STORAGE



REAR ADVENTURE RACK

- Take more gear with integrated MOLLE panels and Lock & Ride installation
- 28 L or 57 L Polaris coolers will still fit in bed with rack installed
- Compatible with (1) Kolpin Stronghold Mount

» 2885113

GENERAL XP 1000/4 '20-24
GENERAL 1000/4 '16-24



KOLPIN STRONGHOLD MOUNT

- Kolpin Stronghold mount for attaching gun boots or other Kolpin Stronghold items to the Rear Adventure Rack

» 2885114

GENERAL XP 1000/4 '20-24
GENERAL 1000/4 '16-24

RHINO-RACK® MOUNT



GUN MOUNTING BRACKET

- Bracket used to mount Kolpin Stronghold Gun Boots to Rhino-Rack systems when paired with Auto-Latch Mount (2884106), sold separately

» 2889327

GENERAL XP 1000/4 '20-24
GENERAL 1000/4 '16-24

See P. 18 for more Rhino-Rack® products

KOLPIN RHINO GRIPS IDEAL FOR BOWS & UNCASSED GUNS



RHINO GRIP PRO

» 2884107

GENERAL XP 1000/4 '20-24
GENERAL 1000/4 '16-24



RHINO GRIP XLR - DOUBLES

» 2889166

GENERAL XP 1000/4 '20-24
GENERAL 1000/4 '16-24



RATCHETING RHINO GRIP

TOP SELLER

» 2881575

GENERAL XP 1000/4 '20-24
GENERAL 1000/4 '16-24



RHINO GRIP PRO REPLACEMENT RUBBER STRAPS (2)

» 2884109

GENERAL XP 1000/4 '20-24
GENERAL 1000/4 '16-24



RHINO GRIP XLR REPLACEMENT RUBBER STRAPS (2)

» 2889204

GENERAL XP 1000/4 '20-24
GENERAL 1000/4 '16-24

COOLERS



MADE FOR RIDERS.
BUILT FOR LIFE.

28, 57 & 99
LITER FEATURES



ComfortCarry
Handles



TravelLock
System



EasyOut
Drain System



NoSlip
Rubber Feet



PolarWall
Insulation



IceLock
Seal



99 LITER

■ ■ ■ SAGEBRUSH GREEN • 2890707
GRAPHITE • 2883426

ACCESSORIES

WIRE BASKET • 2883648
DIVIDER (1) • 2883468
WHEELS • 2883967

Divider



1 way to
partition



57 LITER

■ ■ ■ SAGEBRUSH GREEN • 2890706
GRAPHITE • 2883425

ACCESSORIES

WIRE BASKET • 2882185
DIVIDERS (2) • 2882184
SEAT CUSHION • 2882179
WHEELS • 2882180

Dividers



2 ways to
partition



28 LITER

■ ■ ■ SAGEBRUSH GREEN • 2890705
GRAPHITE • 2883424

ACCESSORIES

WIRE BASKET • 2882438
DIVIDER (1) • 2882186

Divider



1 way to
partition

ESSENTIAL ACCESSORIES SO YOUR COOLER WORKS AS HARD AS YOU DO

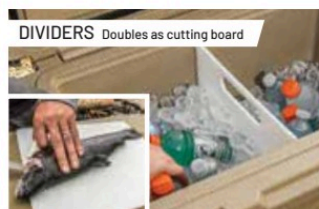
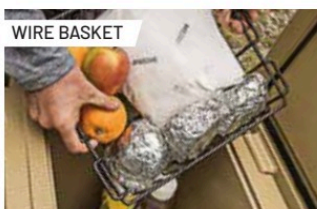



POLARIS
NORTHSTAR
COOLER

POLARIS NORTHSTAR COOLERS CAN SURVIVE JUST ABOUT ANYTHING - FROM EXTREME HEAT TO A NASTY TUMBLE OFF A VEHICLE.



14 LITER

NEW SAGEBRUSH GREEN • 2890704
GRAPHITE • 2883968



19 LITER
SOFT-SIDED COOLER

GRAPHITE • 2889285



HOLDS ICE
FOR AGES

BECAUSE JUST ANY COOLER
WON'T CUT IT OUT THERE.

You need something rugged and reliable. A cooler purpose built to handle the challenges of the off-road—while keeping your provisions on ice for days on end. Because out here, there are no ice machines, and you just left the last one in your dust. So, load it up. Lock it in. And know your NorthStar cooler is staying put—giving you a few extra days of ice time to enjoy the wild.

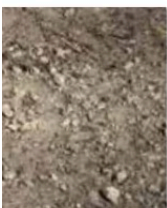

TUMBLER



591 ML • 2883393
NOT AVAILABLE IN EUROPE

QUICKSTRAP



LR LOCK 2882187
ALL COOLERS AND GENERAL
CARGO BOXES

ACCESSORIES

WINDSHIELDS &
REAR PANELS

DOORS

ROOFS &
PROTECTION

STORAGE, CAB
COMFORT & HUNT

COOLERS

CONNECTED TECHNOLOGY
& AUDIO

LIGHTING

WHEELS & TIRES

WINCHES, PLOWES
& TRACKS

CONNECTED TECHNOLOGY

OFF GRID,
BUT NEVER OFF THE MAP.

POLARIS RIDECOMMAND

PLAN YOUR RIDE

Plan an epic ride with stops along the way, customize and adjust your path to maximize your route. You can even share your planned route with friends.

DISCOVER NEW TRAILS

With over 1,000,000 miles of trails available offline, you'll have the confidence to explore further, whether you have cellular coverage or not.



7" DISPLAY POWERED BY RIDE COMMAND*



Bright, 7" touchscreen visible in all conditions

GPS Navigation & Pre-Loaded Maps

Available offline on the in-dash display so you always know where you are.

Route Planning

Add points of interest and waypoints to make the most of your off-road adventure.

Camera Integration

Navigate with full view of your surroundings. Use the integrated rear camera to see others behind you while riding.

Personalized Audio Experience

Seamlessly pair your display via Bluetooth* to wirelessly stream music and stay connected with call and text alerts.

Configurable Gauges

Customize your ride experience with elevation, travel direction, fuel level and more to create relevant screens for you.

» 2884072

GENERAL XP1000 '24

7" DISPLAY MOUNT KIT



- Mount RIDE COMMAND seamlessly into the dash for perfect fit and finish
- Comes with required wiring harnesses and accessory components
- Includes front and rear camera, V2V and GPS antenna

» 2889338

GENERAL XP1000 '24

When replacing Factory In-Dash Audio: EITHER Amp (2414533) and Relocation Kit (2885112), both required sold separately -OR- Stage 3 RIDE COMMAND Audio Kit & Rear Speakers (2885163), sold separately, are required

AUDIO BRACKET

- Used to mount audio amplifier for front and rear speakers when subwoofer is removed
- Required to install a heater on a vehicle with RIDE COMMAND and audio

» 2885112

GENERAL XP1000 '24

*Due to ongoing supply chain issues, there may be delayed or limited availability of this product as an accessory add-on.

AUDIO



PLUG AND PLAY



ELEMENT READY*



NO LOSS OF CARGO SPACE



BLUETOOTH CAPABLE

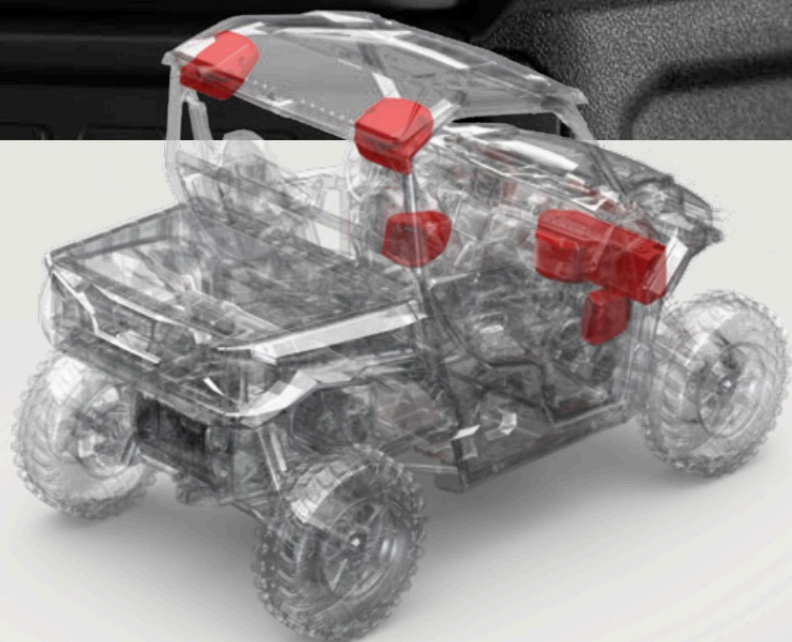

An industry first. A true factory installed integrated off-road audio system. Rockford Fosgate partnered with Polaris to purpose build the highest performing system specifically for the GENERAL platform. Tuned and rider-centric to create a class leading audio experience that is second to none.



PULSE
Electrical Systems

TOP SELLER

STAGE 1 AUDIO KIT

PMX-P2 HEAD UNIT & FRONT COAXIAL SPEAKERS & ANTENNA

- 6.86 cm full color display with AM/FM/WB tuner*, Pandora Control and Bluetooth Connectivity
- **50 Watt** 16.51 cm front coaxial speakers with enclosures and grilles

» 2884282

GENERAL XP 1000/4 '20-24
GENERAL 1000/4 '20-24



PULSE
Electrical Systems

STAGE 3 PMX AUDIO KIT + REAR SPEAKERS

REAR COAXIAL SPEAKERS & AMP

- Two, **50 Watt** 16.51 cm rear coaxial speakers with enclosures and grilles
- **400 Watt** 4-channel full range amplifier
- IP67 Rating delivering water resistance and dust protection

» 2885162

GENERAL XP 1000/4 '20-24
GENERAL 1000/4 '16-24



PULSE
Electrical Systems

TOP SELLER

STAGE 3 RIDE COMMAND AUDIO KIT + REAR SPEAKERS

FRONT & REAR COAXIAL SPEAKERS, ANTENNA & AMP

- Two, **50 Watt** 16.51 cm front and rear coaxial speakers with enclosures and grilles
- **400 Watt** 4-channel full range amplifier
- IP67 Rating delivering water resistance and dust protection

» 2885163

GENERAL XP 1000/4 '20-24
GENERAL 1000/4 '16-24

(U.S. MODELS ONLY)

Requires 7" Display with RIDE COMMAND (2884072) & 7" Display Mount Kit (2884283), both sold separately



PULSE
Electrical Systems

STAGE 4 UPGRADE POWERED SUBWOOFER

- Compatible with Stage 1 and Stage 2 PMX-P2 Audio Kits
- **400 Watt** 25.4 cm subwoofer
- Compatible with Stage 1 and Stage 3 Audio Kits

» 2889306

GENERAL XP 1000/4 '20-24
GENERAL 1000/4 '16-24

Not Compatible with Heater Kit (2881316)

Requires RIDE COMMAND. For use with PMX, substitute for 2889053



BUILD YOUR SOUND

	HEAD UNIT:	PMX-P2		RIDE COMMAND
	AUDIO:	STAGE 1 AUDIO KIT	STAGE 3 + 4 UPGRADES	STAGE 3 RIDE COMMAND AUDIO KIT <small>(U.S. MODELS ONLY)</small>
XP + DELUXE		STAGE 1 AUDIO KIT WITH PMX-P2 HEAD UNIT INSTALLED	STAGE 3 + REAR SPEAKERS UPGRADE REAR SPEAKERS, AMP + AUDIO BRACKET 2885162	RIDE COMMAND + STAGE 3 AUDIO SYSTEM BY ROCKFORD FOSGATE INSTALLED <small>To add 8-Vent Heater & Defrost System (2881316), Subwoofer must be removed and Amp Relocation Bracket (2885112) must be installed</small>
PREMIUM + DELUXE		STAGE 1 AUDIO KIT PMX HEAD UNIT + FRONT COAXIAL SPEAKERS + ANTENNA 2884282	OPTIONAL SUBWOOFER STAGE 4 UPGRADE SUBWOOFER 2889306 <small>Not compatible with 8-Vent Heater & Defrost System (2881316)</small> <small>Requires RIDE COMMAND. For use with PMX, substitute for 2889053</small>	7" DISPLAY WITH RIDE COMMAND* 2884072 + 7" DISPLAY MOUNT KIT 2889338 <small>2020-2024 MODELS</small> + STAGE 3 UPGRADE REAR SPEAKERS, AMP + AUDIO BRACKET 2885163 + STAGE 4 UPGRADE SUBWOOFER 2889306 <small>Not compatible with 8-Vent Heater & Defrost System (2881316)</small>

*Due to ongoing supply chain issues, there may be delayed or limited availability of this product as an accessory add-on.



**POLARIS ENGINEERED
ADVANTAGES**

MOUNTS PERFECTLY
Designed for your Polaris Engineered
bumper, roof or other mounting point

**ADVANCED
TECH**

RIGID lights are driven by Aluminum PCB Smart Boards, 6063-T5 aircraft aluminum extruded housings and Tiger Drylac UV protection polyester powdercoating.

**EXCLUSIVE
OPTICS**

RIGID invests heavily in optical science and has patented multiple optics and optics systems, maximizing light output and efficiency.

LIGHT BAR TYPES



SR-SERIES PRO

Sleek, powerful, low-profile (under 5 cm tall).
Lights extreme distances with low energy usage.
Available in 25.4 cm & 81.3 cm



D-SERIES PRO

Compact to fit almost anywhere with high
output and low energy usage.
Available in Driving, Flood & Spot

OPTICS DRIVING FLOOD SPOT

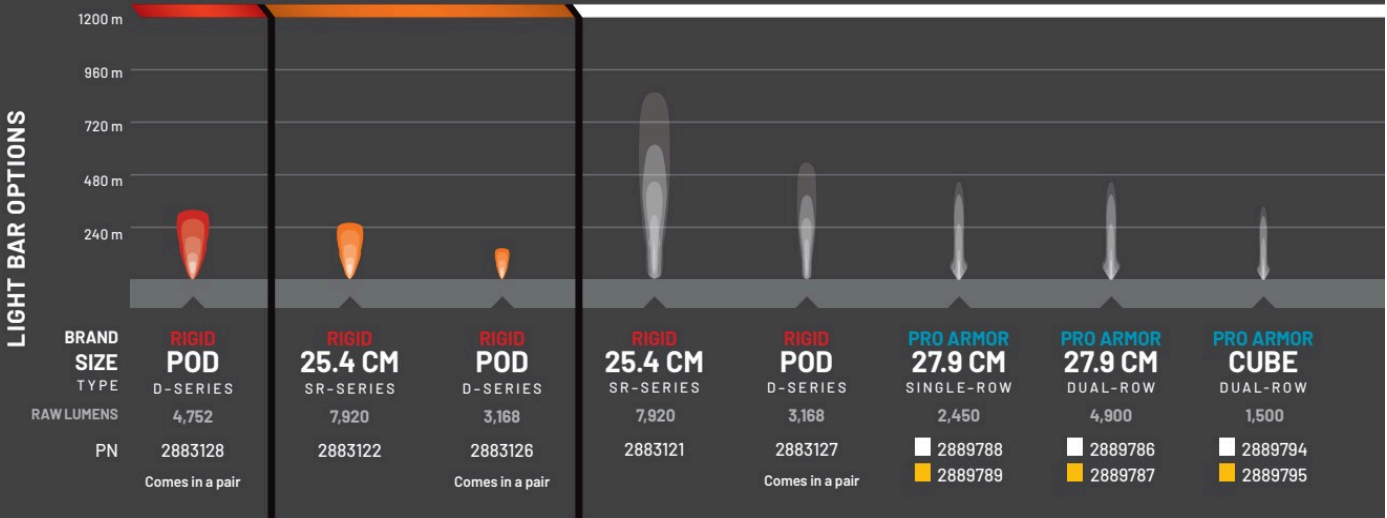

**BUILD YOUR
VISION**

Consider the optics, angle & how you will use your vehicle to choose the right light or set of lights.

OPTICS LIGHT ANGLE	ACCENT	DRIVING (45°)	FLOOD (25°)	SPOT (10°)	COMBO (25°/10°)
DRIVING SPEED	All	Slow to medium	Slow to medium	High	All
BEAM	Diffused glow	Extra-wide	Wide/shorter	Concentrated/long	Inner spot & outer flood
RECOMMENDED MOUNTING	Low/wheel well	All points	Low/rear	High points	All points
TERRAIN & RIDING STYLE	Added style & personalization in any terrain	All riding & utility	Wide-open terrain or trails & utility	Trail & tight conditions	All riding & utility

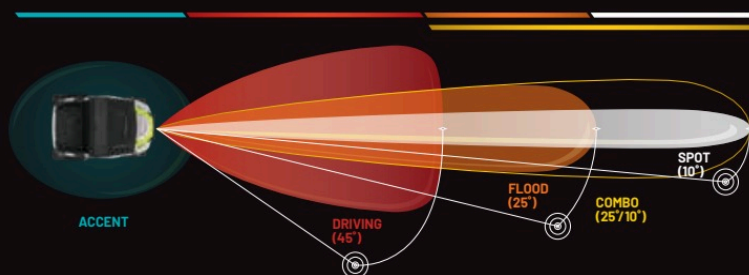

MAX PERFORMANCE

Validated to work as hard as your machine does

DOESN'T OVERTAX

Trust it to work when you need it to

PRO ARMOR



RUGGED CONSTRUCTION

Pro Armor lights are designed to be big and beefy with an aggressive style all their own, and housed in IP67 marine-grade rated UV polyester powdercoating.

MASSIVELY BRIGHT

Pro Armor builds bright lights designed for any riding experience. All that power is directed through heat dissipating aluminum for streamlined heat management.



DUAL-ROW LED

The most spread and farthest illumination downrange. Easy to mount.
Available in 27.9 cm & 78.7 cm



SINGLE-ROW LED

Powerful, compact, low-profile light bars with sleek look.
Available in 27.9 cm, 50.8 cm & 101.6 cm



CUBE LED

Small size allows mounting in strategic locations for added lighting.
Available in Spot

COMBO

OPTICS



1,200 m
960 m
720 m
480 m
240 m

RIGID
81.3 CM
SR-SERIES
20,064
2884299

RIGID
25.4 CM
SR-SERIES
7,920
2883123

PRO ARMOR
101.6 CM
SINGLE-ROW
7,600
2889793

PRO ARMOR
83.8 CM
SINGLE-ROW
7,500
2889791

PRO ARMOR
78.7 CM
DUAL-ROW
13,500
2889790

PRO ARMOR
50.8 CM
SINGLE-ROW
4,700
2889792

BRAND
SIZE
TYPE
RAW LUMENS
PN

ADD A HARNESS TO MOUNT YOUR LIGHTS

MODEL	LIGHT BAR SET-UPS	
	1 LIGHT IN 1 LOCATION ON 1 SWITCH	2 LIGHTS IN 2 LOCATIONS ON 1 SWITCH
2019-2024 ALL MODELS	POLARIS PULSE LED LIGHT BAR HARNESS 2883785	POLARIS PULSE LED LIGHT BAR HARNESS 2883785 Y-HARNESS 2879860



NEW LIGHT BAR MOUNT

- Optional cast mount for added style
 - Compatible with all Pro Armor light bars
- » 2890053

⚠ No battery connection cables required on any model/model year GENERAL 1000.



All RIGID and Pro Armor lights are Polaris PULSE ready.

ACCESSORIES

WINDSHIELDS & REAR PANELS

DOORS

ROOFS & PROTECTION

STORAGE, CAB COMFORT & HUNT

COOLERS

CONNECTED TECHNOLOGY & AUDIO

LIGHTING

WHEELS & TIRES

WINCHES, PLOWS & TRACKS

WHEELS & TIRES



KNOW YOUR TIRES

DIMENSIONS			USAGE	TREAD DEPTH	TIRE WEIGHT	PLY RATING	SIDEWALL BELTS	LOAD RATING
30" x 10" R15 Part Number			FRONT/ REAR	16 mm	18 kg	8	3	499 kg
TIRE HEIGHT	TIRE WIDTH	WHEEL DIAMETER	Where can you use the tire	Deeper treads have more grip in all conditions	A lighter tire makes for improved vehicle performance	Indicates tire puncture-resistance	Increase your resistance to sidewall punctures	How much weight can the tire handle

WAYS TO SHOP >>>

TIRES BY SIZE



PRO ARMOR.

27"	28"	29"	30"
HARVESTER	ATTACK 2.0	DUAL-THREAT	ATTACK 2.0
MUD XC	CRAWLER XG	HD-K	CRAWLER AT
TREKKER	CRAWLER XR	MUD XC	CRAWLER XG
	HARVESTER	TREKKER	CRAWLER XP
			CRAWLER XR
			HARVESTER
			MUD XC
			TREKKER

SUPERIOR PERFORMANCE & DURABILITY

LIFELONG PERFORMANCE

- Every tire is designed and constructed with longevity in mind
- 3,000+ mile rated (4,828 kilometers)

PREMIUM PROTECTION

- Pro Armor makes tires with extra protection exactly where it's needed most – the sidewall
- Triple-belted sidewalls keep your tires more resistant so you can keep going

TOUGH TIRES

- Higher ply ratings mean added protection
- Pro Armor builds 8 or 10-ply rated tires for higher puncture-resistance

KNOW YOUR TERRAIN



- Tread patterns optimized for extreme traction
- Ideal for both hard pack & loose trail



- Provides traction & durability
- Performs in hard sand, jagged rocks or any extreme terrain



- Flexible "grippy" tread
- Aggressive side bite



- Extra deep treads
- Self-cleaning lugs



- Triple-belted sidewalls to resist puncture
- Purpose-built, long lasting tread patterns



- Handles extreme cold
- Holds shape & provides traction

KNOW YOUR WHEELS

STEP 1: SELECT YOUR SERIES

4 = 40-SERIES 5 = 50-SERIES

STEP 2: CHOOSE YOUR LOAD RATING

1 = <362.9 KG 2 = 363 - 589.7 KG 3 = 590 - 726+ KG

STEP 3: PICK YOUR STYLE

OFFSET / BEADLOCK / COLOR

INCREASE OFFSET FROM STOCK = NARROWER STANCE
DECREASE OFFSET FROM STOCK = WIDER STANCE

TIRES BY TERRAIN

TRAIL	ROCK	DESERT	MUD	UTILITY	SNOW
ATTACK 2.0	ATTACK 2.0	ATTACK 2.0	MUD XC	HARVESTER	ATTACK 2.0
CRAWLER AT	CRAWLER AT	CRAWLER AT		HD-K	HARVESTER
CRAWLER XG	CRAWLER XG	CRAWLER XG		TREKKER	HD-K
CRAWLER XP	CRAWLER XP	CRAWLER XP			
CRAWLER XR	CRAWLER XR	CRAWLER XR			
DUAL-THREAT	DUAL-THREAT	DUAL-THREAT			
HARVESTER					
HD-K					
MUD XC					
TREKKER					

WHEELS BY SIZE

14"	15"
40-SERIES (11 TIRE OPTIONS)	50-SERIES (10 TIRE OPTIONS)
4201	5201
4202	5202
4203 BEADLOCK	5203 BEADLOCK
4204	5204
4205	5301 BEADLOCK
4301 BEADLOCK	
HD DUAL BEADLOCK	

For off-road use only. Please check fitment with your dealer.

TIRES



FRONT/REAR

PRO ARMOR CRAWLER XR

- Premium grip for all terrains, from the trail to the rocks
- Square block profile for even surface contact
- A tougher durometer than the XG to take on the toughest the trail has to offer

		TREAD DEPTH	TIRE WEIGHT	PLY RATING	SIDEWALL BELTS	LOAD RATING
14"	28" x 10" R14 5415536	16 mm	15 kg	8	3	517 kg
15"	30" x 10" R15 5418254		16.8 kg			581 kg



WHEEL SIZE

14"

15"



FRONT/REAR

PRO ARMOR CRAWLER XG

- Built to crawl over all obstacles, both large and small
- A soft, sticky compound makes this tire ideal for both rock crawling and desert running
- 8-ply, triple-belted ballistic sidewalls resist punctures

		TREAD DEPTH	TIRE WEIGHT	PLY RATING	SIDEWALL BELTS	LOAD RATING
14"	30" x 10" R14 5415616	20 mm	17 kg	8	3	581 kg
15"	28" x 10" R15 5416346		15 kg			498 kg
15"	30" x 10" R15 5416397		18 kg			630 kg



WHEEL SIZE

14"

15"

WHAT CRAWLER ARE YOU?



XR

SINGLE DUROMETER

- Smaller lug height and single durometer gives this high-speed tire added rigidity and lateral stability when cornering
- Unique lug design excels in hard-pack, fast terrain



XG

DUAL-DUROMETER

- Taller lug height and dual-durometer construction
- Perfect balance between high-speed performance, durability and flex in order to grip slick rock



FRONT/REAR

PRO ARMOR CRAWLER AT

- Directional tread for optimum performance
- Greater lug separation for easy mud clean out
- 8-ply, triple-belted ballistic sidewalls resist punctures

		TREAD DEPTH	TIRE WEIGHT	PLY RATING	SIDEWALL BELTS	LOAD RATING
15"	30" x 10" R15 5417534	FRONT/ REAR 18 mm	16 kg	8	3	581 kg



WHEEL SIZE
15"



FRONT/REAR

NEW PRO ARMOR CRAWLER XP

- Ideal for overlanding, rock crawling and desert running with a soft, sticky compound
- Built to maneuver over large and small obstacles
- 8-ply, triple-belted ballistic sidewalls with anti-puncture strength

		TREAD DEPTH	TIRE WEIGHT	PLY RATING	SIDEWALL BELTS	LOAD RATING
15"	30" x 10" R15 5418329	FRONT/ REAR 20 mm	17 kg	8	3	580 kg



WHEEL SIZE
15"



AT

DIRECTIONAL LUG PATTERN

- The same taller lug height as Crawler XG, providing more grip and better traction
- Wider lug spacing for excellent mud clean-out



XP

DUAL-DUROMETER

- Channeled outer lugs for superior handling in soft dirt and clay
- Extended side lugs for greater traction on rocks and in sand

For off-road use only. Please check fitment with your dealer.

TIRES



FRONT/REAR

PRO ARMOR ATTACK 2.0

- Engineered for excellent hard pack performance
- Dual-compound technology and radial construction offer performance in all terrains
- Tight thread pattern for a quieter ride

		TREAD DEPTH	TIRE WEIGHT	PLY RATING	SIDEWALL BELTS	LOAD RATING
15"	28" x 10" R15 5416344	FRONT/ REAR 25 mm	15 kg	10	3	503 kg
15"	30" x 10" R15 5416345		17 kg			560 kg



WHEEL SIZE

15"

TIGHTER TREAD PATTERN =
Better traction in hard-pack

DUAL-DUROMETER LUG =
Increased grip & traction in rough terrain, smoother ride in all terrain

10-PLY RATED =
Increased durability

LARGER 30" SIZE OFFERING =
More ground clearance & trail traction



FRONT/REAR

NEW PRO ARMOR TREKKER

- Specialized tread design provides a quiet ride
- Graduated lug depth maximizes the contact patch for ultimate predictability
- 8-ply, triple belted nylon construction

		TREAD DEPTH	TIRE WEIGHT	PLY RATING	SIDEWALL BELTS	LOAD RATING
14"	27" x 10" R14 5418674	FRONT/ REAR 11-17 mm graduated	13 kg	8	3	490 kg
14"	29" x 10" R14 5418675		13 kg			547 kg
15"	30" x 10" R15 5418676		15 kg			560 kg



WHEEL SIZE

14"

15"



FRONT/REAR

PRO ARMOR DUAL-THREAT

- Dual-compound technology and radial construction offer performance in all terrains
- Softer durometer rubber on outer edge for overall superior grip and feel
- Harder durometer rubber in the middle for increased traction during acceleration and longer tread life

		TREAD DEPTH	TIRE WEIGHT	PLY RATING	SIDEWALL BELTS	LOAD RATING
14"	29" x 9" R14 5418342	FRONT 16 mm	14 kg	10	3	499 kg
14"	29" x 11" R14 5418343		16 kg			599 kg



WHEEL SIZE

14"

DUAL-COMPOUND = MORE GRIP + LONGER LIFE

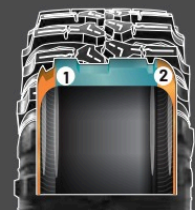

1 Firmer Durometer Rubber = Longer Life

2 Softer Durometer Rubber = More Grip



FRONT/REAR

PRO ARMOR MUD XC

- Designed as the perfect mud-trail crossover for a smooth ride on the trail and aggressive traction in the mud
- Dual-compound technology with harder durometer lugs promote extended wear, increasing tire life
- 10-ply construction means added protection in the toughest terrain

		TREAD DEPTH	TIRE WEIGHT	PLY RATING	SIDEWALL BELTS	LOAD RATING
14"	27" x 9" R14 5416947	FRONT	14 kg	10	3	531 kg
14"	27" x 11" R14 5416948	REAR	15 kg			599 kg
14"	29" x 10" R14 5416946	FRONT/REAR	18 kg			630 kg
15"	30" x 10" R15 5418253	FRONT/REAR	16.8 kg			581 kg



WHEEL SIZE



FRONT/REAR

PRO ARMOR HARVESTER

- All-around work horse with tread life of 8,047 km
- Tread pattern designed to withstand anything from the farmyard to the pastures and the trail
- With 10-ply, it can carry the load day in and day out

		TREAD DEPTH	TIRE WEIGHT	PLY RATING	SIDEWALL BELTS	LOAD RATING
14"	27" x 10" R14 5415965	FRONT/REAR	15 kg	10	3	599 kg
14"	28" x 10" R14 5416347		15 kg			630 kg
15"	30" x 10" R15 5417529		FRONT/REAR			17 kg



WHEEL SIZE



FRONT/REAR

PRO ARMOR HD-K

- Designed to provide a smooth ride and aggressive traction in all riding terrains
- Triple-belted sidewall provides extreme protection and extends the tire life
- Quad belt tread core offers superior protection and longer tread life

		TREAD DEPTH	TIRE WEIGHT	PLY RATING	SIDEWALL BELTS	LOAD RATING	
14"	29" x 10" R14 5417507	FRONT/REAR	31.75 mm	18 kg	10	3/1 Aramid	598 kg



WHEEL SIZE



WHEELS



BEADLOCK REQUIRED

BEADLOCK INCLUDED

INNER & OUTER
BEADLOCK INCLUDED

BEADLOCK REQUIRED

BEADLOCK INCLUDED

14" 40-SERIES

15" 50-SERIES

A 4201 ○

FRONT WEIGHT:	5.9 KG	LOAD RATING:	408 KG	OFFSET:	+9
REAR WEIGHT:	6.4 KG	LOAD RATING:	590 KG	OFFSET:	+9
ACCENT:	FRONT	14" x 7"	1522956-266		
	REAR	14" x 8"	1522957-266		
MATTE BLACK:	FRONT	14" x 7"	1522956-458		
	REAR	14" x 8"	1522957-458		

B 4202 ○

FRONT WEIGHT:	5.8 KG	LOAD RATING:	408 KG	OFFSET:	+4
REAR WEIGHT:	6.1 KG	LOAD RATING:	590 KG	OFFSET:	-9
ACCENT:	FRONT	14" x 7"	1522544-266		
	REAR	14" x 8"	1522545-266		
MATTE BLACK:	FRONT	14" x 7"	1522544-458		
	REAR	14" x 8"	1522545-458		

C 4203 BEADLOCK ○ ○

FRONT WEIGHT:	5.9 KG	LOAD RATING:	408 KG	OFFSET:	+4
REAR WEIGHT:	6.6 KG	LOAD RATING:	590 KG	OFFSET:	-9
MATTE BLACK:	FRONT	14" x 7"	1522238-458		
	REAR	14" x 8"	1522239-458		

D 4204 ○

FRONT WEIGHT:	5.9 KG	LOAD RATING:	408 KG	OFFSET:	+4
REAR WEIGHT:	6.4 KG	LOAD RATING:	590 KG	OFFSET:	-9
ACCENT:	FRONT	14" x 7"	1522546-266		
	REAR	14" x 8"	1522547-266		
MATTE BLACK:	FRONT	14" x 7"	1522546-458		
	REAR	14" x 8"	1522547-458		

E 4205 ○

FRONT WEIGHT:	5.8 KG	LOAD RATING:	408 KG	OFFSET:	+4
REAR WEIGHT:	5.7 KG	LOAD RATING:	590 KG	OFFSET:	-9
MATTE BLACK:	FRONT	14" x 7"	1521507-521		
	REAR	14" x 8"	1521508-521		
LUSTER:	FRONT	14" x 7"	1521507-410		
	REAR	14" x 8"	1521508-410		

F 4301 BEADLOCK

WEIGHT:	7.3 KG	LOAD RATING:	729 KG	OFFSET:	+38
ACCENT:	FRONT/REAR	14" x 7"	1523284		
MATTE BLACK:	FRONT/REAR	14" x 7"	1523283		

G HD DUAL BEADLOCK

WEIGHT:	18 KG	LOAD RATING:	729 KG	OFFSET:	+38
MATTE BLACK:	FRONT/REAR	14" x 7"	1524022-458		

H 5201

WEIGHT:	7.8 KG	LOAD RATING:	590 KG	OFFSET:	+4
ACCENT:	FRONT/REAR	15" x 7"	1523184-266		
MATTE BLACK:	FRONT/REAR	15" x 7"	1523184-458		

I 5202

WEIGHT:	8.1 KG	LOAD RATING:	590 KG	OFFSET:	+4
ACCENT:	FRONT/REAR	15" x 7"	1523102-266		
MATTE BLACK:	FRONT/REAR	15" x 7"	1523102-458		

J 5203 BEADLOCK ○ ○

WEIGHT:	7.3 KG	LOAD RATING:	590 KG	OFFSET:	+38
MATTE BLACK:	FRONT/REAR	15" x 7"	1522435-458		

K 5204 ○

WEIGHT:	6.1 KG	LOAD RATING:	590 KG	OFFSET:	+55
MATTE BLACK:	FRONT/REAR	15" x 7"	1522550-458		

L 5301 BEADLOCK

WEIGHT:	7.7 KG	LOAD RATING:	726 KG	OFFSET:	+38
ACCENT:	FRONT/REAR	15" x 7"	1523282		
MATTE BLACK:	FRONT/REAR	15" x 7"	1523266		

○ Lug Nuts required ○ Beadlock sold separately

BEADLOCK RINGS

14" FORGED BEADLOCK RINGS

- Machined 1522244-266
4203 Beadlock & HD Dual Beadlock
- Matte Black - Replacement 1523146-458
5301 Beadlock & HD Dual Beadlock

15" FORGED BEADLOCK RINGS

- Matte Black - Replacement 1523147-458
5203 Beadlock



KNOW YOUR WHEELS

STEP 1: SELECT YOUR SERIES

4 = 40-SERIES 5 = 50-SERIES

STEP 2: CHOOSE YOUR LOAD RATING

1 = <362.9 kg 2 = 363 - 589.7 kg 3 = 590 - 726+ kg

STEP 3: PICK YOUR STYLE

OFFSET / BEADLOCK / COLOR

INCREASE OFFSET FROM STOCK = NARROWER STANCE
DECREASE OFFSET FROM STOCK = WIDER STANCE

KNOW YOUR TERRAIN



- Tread patterns optimized for extreme traction
- Ideal for both hard pack and loose trail



- Extra deep treads
- Self-cleaning lugs



- Triple-belted sidewalls to resist puncture
- Purpose-built, long lasting tread patterns



- Flexible "grippy" tread
- Aggressive side bite

WHEEL & TIRE SETS

14"

40-SERIES

	TRAIL		MUD		UTILITY		ROCK	
	DUAL-THREAT 29"	TREKKER 27"	MUD XC 27"	29"	HARVESTER 27"	28"	CRAWLER XR 28"	CRAWLER XG 30"
4201 ACCENT	2883146		2884272	2884265	2882388	2883225	2882394	2882396
4201 MATTE BLACK	2883147		2884273	2884266	2882389	2883226	2882395	2882397
4202 ACCENT	2883148	2890907	2884267	2884260	2882383	2883220	2881343	2881560
4202 MATTE BLACK	2883149	2890905	2884268	2884261	2882384	2883221	2881344	2881561
4203 BEADLOCK MATTE BLACK BEADLOCKS SOLD SEPARATELY							2881386	
4204 ACCENT	2883150		2884270	2884263	2882385	2883222	2881355	2881558
4204 MATTE BLACK	2883151		2884271	2884264	2882386	2883223	2881356	2881559
4205 LUSTER							2881371	2881564
4205 MATTE BLACK	2883152		2884269	2884262	2882387	2883224	2881372	2881563
4301 BEADLOCK ACCENT BEADLOCKS PRE-MOUNTED	2883219						2883213	2883211
4301 BEADLOCK MATTE BLACK BEADLOCKS PRE-MOUNTED	2883218						2883212	2883210

REPLACEMENT CAPS

POLARIS

HD MATTE BLACK 5457498-458 ALL WHEELS

PRO ARMOR

LUSTER 5453209-410 ALL WHEELS EXCEPT 5203 BEADLOCK & 5204

LUSTER 1523015-410 5203 BEADLOCK

MATTE BLACK 1523015-458

MATTE BLACK 1523063-458 5204

12mm x 1.5 SPLINED LUG NUTS

Lug Nuts required

16 SPLINED LUG NUTS WITH WRENCH ADAPTER 2879332

4 SPLINED LUG NUTS WITHOUT WRENCH 2879331

12mm x 1.5 SPLINED LUG WRENCH 2204966

15"

50-SERIES

	TRAIL		CRAWLER AT 30"	TREKKER 30"	UTILITY HARVESTER 30"	ROCK		CRAWLER XP 30"
	ATTACK 2.0 28"	30"				CRAWLER XG 28"	30"	
5201 ACCENT	2883160	2883169	2889510			2883188	2883179	2889950
5201 MATTE BLACK	2883159	2883168	2889511			2883187	2883178	2889951
5202 ACCENT	2883158	2883167	2889512		2885045	2883186	2883177	2889952
5202 MATTE BLACK	2883157	2883166	2889513	2890916	2885046	2883185	2883176	2889953
5203 BEADLOCK MATTE BLACK BEADLOCKS SOLD SEPARATELY	2883154	2883163	2889516		2885049	2883182	2883173	2889956
5204 MATTE BLACK	2883155	2883164	2889517		2885051	2883183	2883174	2889957
5301 BEADLOCK ACCENT BEADLOCKS PRE-MOUNTED	2883162	2883171	2889514	2890914	2885047	2883180	2883181	2889954
5301 BEADLOCK MATTE BLACK BEADLOCKS PRE-MOUNTED	2883161	2883170	2889515	2890913	2885048	2883189	2883180	2889955

Lug Nuts required

2 WAYS TO PURCHASE

INDIVIDUAL WHEELS & TIRES - OR - COMPLETE SETS AS LISTED

Exclusively at Polaris Authorized Dealers

For off-road use only. Please check fitment with your dealer.

ACCESSORIES

WINDSHIELDS & REAR PANELS

DOORS

ROOFS & PROTECTION

STORAGE, CAB COMFORT & HUNT

COOLERS

CONNECTED TECHNOLOGY & AUDIO

LIGHTING

WHEELS & TIRES

WINCHES, PLOWES & TRACKS

WINCHES

TESTED 1,200+ PULLS AT MAX LOAD

OPERATES FULLY SUBMERGED

BUILT TO WITHSTAND -29° C TEMPERATURES

MILITARY TESTED & APPROVED

PRO PRO HEAVY DUTY SERIES

BEST FOR PLOWING, HEAVY-DUTY OUTDOOR CHORES & TRAIL RIDING

HD HEAVY DUTY SERIES

BEST FOR THE CASUAL OFF-ROAD RIDER

FEATURES & BENEFITS

ALL POLARIS ENGINEERED WINCHES COME WITH:

- ✓ INTEGRATED WIRING, MOUNT, PREASSEMBLED
- ✓ HOOK WITH STRAP
- ✓ CUT STEEL GEARS & SEALED DRIVETRAIN
- ✓ SEALED PERMANENT MAGNET MOTOR

RAPID ROPE RECOVERY

5X
FASTER

Retrieve cable 5x as fast as standard mode on other Polaris winches. Get back to riding or complete your task quicker.

1. Set winch dial to N (Neutral) to manually pull the rope out and secure the hook to your anchor point
2. Set winch dial to L (Low) for maximum pulling power while winching your load
3. Set winch dial to H (High) for retrieving the rope 5x faster with Rapid Rope Recovery



NOT AVAILABLE

AUTO STOP TECHNOLOGY



Auto Stop technology protects and extends the life of your winch by automatically stopping the winch at the end of pull to prevent over-spooling. While plowing, it prevents the plow frame from bending by stopping the winch once the plow has been lifted.



ADD AUTO STOP UPGRADE

2881288

SYNTHETIC ROPE REQUIRED



PREMIUM SYNTHETIC ROPE

With its lightweight, yet extremely strong, design and superior flexibility, this 15 m long synthetic rope is easy to handle and can stand up to any tough job.



ADD SYNTHETIC ROPE

2879187



WIRELESS REMOTE



This convenient remote operates your Polaris winch wirelessly from within 15 m of the vehicle. Operate your winch safely outside your vehicle while on the job site or trails.



ADD WIRELESS REMOTE

2881287



MODEL

2,041 kg

2,041 kg

GENERAL XP 1000/4 '20-24

GENERAL 1000/4 '19-24

2883861

TOP SELLER

2883860

PLOWS & TRACKS

PLOW SYSTEMS (WINCH REQUIRED, SOLD SEPARATELY)

Choose a Glacier Plow System, designed to help you get the most out of your GENERAL during snowy months. Select a system based on your plowing needs with premium add-ons including a hydraulic lift system or additional plow accessories.

GLACIER PRO HD PLOW SYSTEM WITH HYDRAULICS

System includes:

- Mount (2881763)
- Frame (2880260)
- 183 cm Steel Plow (2880270)
- Hydraulic Angle (2889052)
- Hydraulic Controller (2883391)
- Plow Markers (2872726)
- Plow Deflector (2858541)

» 3880014

GENERAL XP 1000/4 '20-24
GENERAL 1000/4 '16-24

Requires lift method:
See winches below.

GLACIER PRO HD PLOW SYSTEM

System includes:

- Mount (2881763)
- Frame (2880260)
- 168 cm Poly Plow (2880269)

» 3880015

GENERAL XP 1000/4 '20-24
GENERAL 1000/4 '16-24

Requires lift method:
See winches and hydraulic lift options below.

GLACIER HD PLOW SYSTEM

System includes:

- Mount (2883256)
- Frame (2882927)
- 183 cm Steel Plow (2880270)

» 3880016

GENERAL XP 1000/4 '20-24
GENERAL 1000/4 '16-24

Requires lift method:
See winches and hydraulic lift options below.

CHOOSE A PLOW SYSTEM

GLACIER PRO HD PLOW SYSTEM

183 cm or 168 cm blades Choice of poly or steel Manual angle system standard

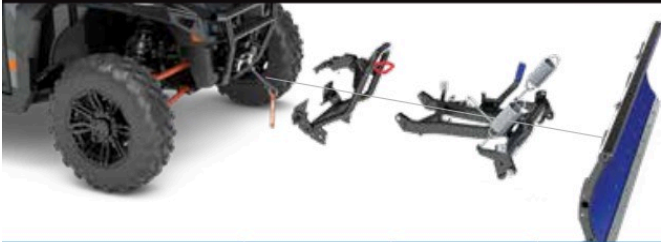

CREATE YOUR PLOW SYSTEM	STEP 1 SELECT A MOUNT	STEP 2 SELECT A FRAME	STEP 3 SELECT A LIFT METHOD	STEP 4 SELECT A BLADE	STEP 5 SELECT ACCESSORIES
GENERAL XP 1000/4 '20-24 GENERAL 1000/4 '16-24	2881763	TOP SELLER 2880260	Polaris PRO HD 2,041 kg Winch 2883861 GENERAL XP 1000/4 '20-24 GENERAL 1000/4 '19-24 Hydraulic Plow Angle 2889052 GENERAL 1000/4 '16-18 Hydraulic Plow Controller 2883391 GENERAL XP 1000/4 '20-24 GENERAL 1000/4 '16-24	TOP SELLER 183 cm Steel 2880270 168 cm Poly 2880269 TOP SELLER 168 cm Steel 2880268	183 cm Blade Snow Deflector 2858541 183 cm HD Wear Bar 2879875 183 cm Wear Bar 2204976 168 cm Blade Snow Deflector 2879866 168 cm HD Wear Bar 2879868 168 cm Wear Bar 2879867 Plow Marker 2872726 168 cm Blade Plow Shoe 2208864 Shear Pin 2205527 Replacement T Shear Pin 2204829 Extension for Tracks 2880267 Heavy Duty Deflector 2884160

GLACIER HD PLOW SYSTEM

168 cm blades Choice of poly or steel Manual angle system standard

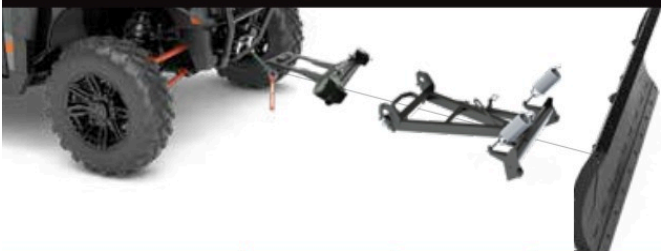

Choose a steel blade for longevity and increased rigidity or a lightweight non-stick, poly blade that's easier on plowing surfaces.

CREATE YOUR PLOW SYSTEM	STEP 1 SELECT A MOUNT	STEP 2 SELECT A FRAME	STEP 3 SELECT A LIFT METHOD	STEP 4 SELECT A BLADE	STEP 5 SELECT ACCESSORIES
GENERAL XP 1000/4 '20-24 GENERAL 1000/4 '16-24	2883256	2889307	Polaris HD 2,041 kg Winch 2883860 GENERAL XP 1000/4 '20-24 GENERAL 1000/4 '19-24	168 cm Poly 2880269 TOP SELLER 168 cm Steel 2880268	168 cm Blade Snow Deflector 2879866 168 cm HD Wear Bar 2879868 168 cm Wear Bar 2879867 Plow Marker 2872726 168 cm Plow Shoe 2208864 Shear Pin 2205527 Replacement T Shear Pin 2204829

BUILD A PLOW SYSTEM



PROSPECTOR PRO TRACK MOUNTS

• Install in place of tires and wheels. Tracks sold separately.

» 2880649
GENERAL 1000/4 '16-24

» 2885117
GENERAL XP 1000/4 '20-24

PROSPECTOR PRO 2.0 TRACK SYSTEM

» 2889487

GENERAL 1000/4 '16-24
GENERAL XP 1000/4 '20-24

If using Glacier Pro Plow System, Track Plow Extension is required (2880267)

ACCESSORIES

WINDSHIELDS & REAR PANELS

DOORS

ROOFS & PROTECTION

STORAGE, CAB COMFORT & HUNT

COOLERS

CONNECTED TECHNOLOGY & AUDIO

LIGHTING

WHEELS & TIRES

WINCHES, PLOWS & TRACKS

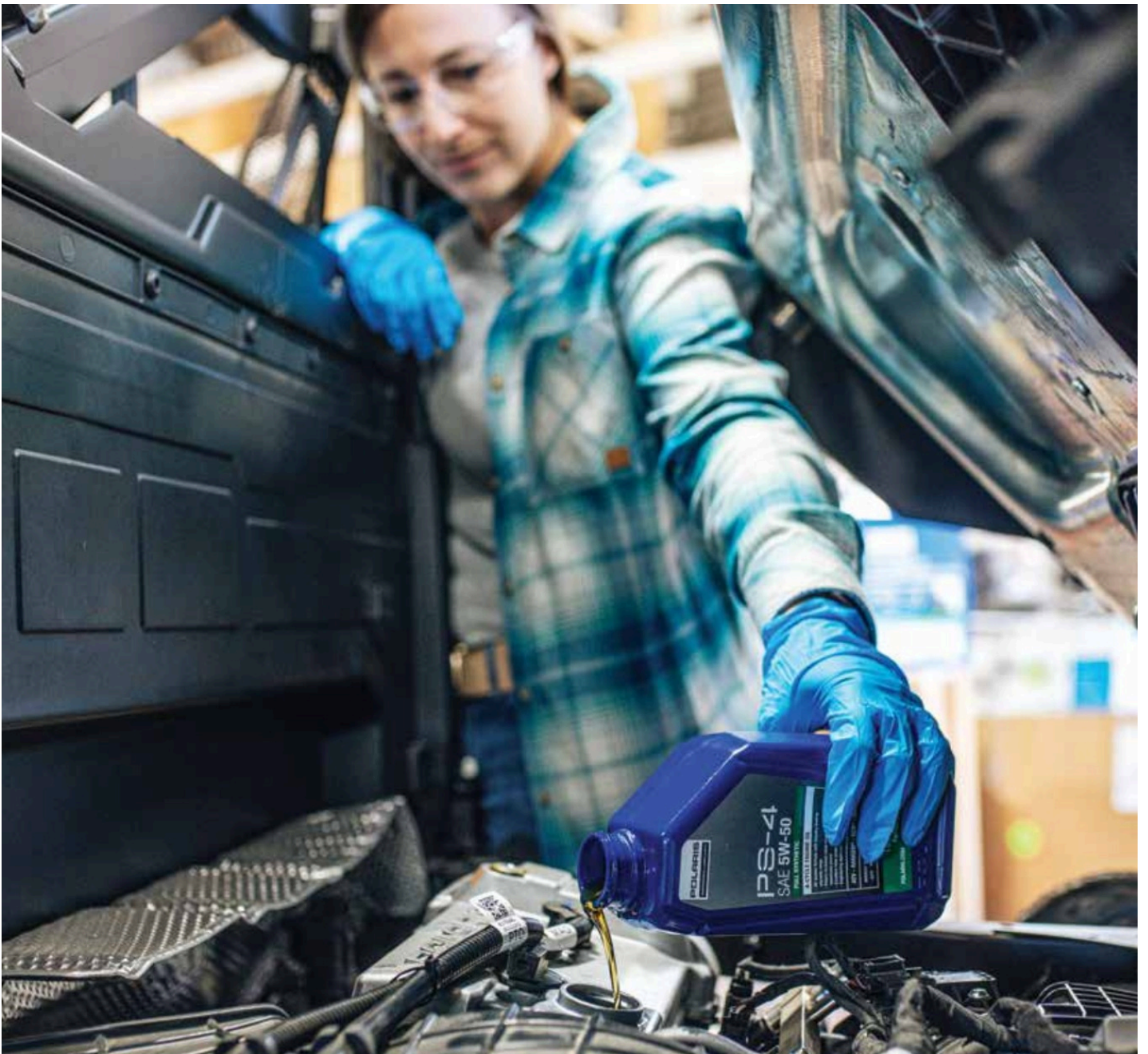

MAINTENANCE & GARAGE

FACTORY APPROVED. Every Polaris vehicle has been engineered and manufactured to deliver performance. Keep it that way by using the same lubricants, cleaners and service parts our factory-trained technicians use.

POLARIS
ENGINEERED

MAINTENANCE & GARAGE

MAINTENANCE

OIL & LUBRICANTS

MAINTENANCE
FLUIDS

HO PARTS

SERVICE PARTS

CLEANERS
& TRAILERING



FOR THE LIFE OF YOUR RIDE

PUSH THE LIMITS WITHOUT SACRIFICING STRENGTH, LONGEVITY AND DURABILITY.
Polaris parts are engineered specifically for your machine, to ensure you get the most out of each ride.

MAINTENANCE TIP

BREAK-IN PERIOD

The break-in period for your new GENERAL is the first 25 hours of operation, or the time it takes to use the first two tanks of fuel. No single action on your part is as important as a proper break-in period. Careful treatment of a new engine will result in more efficient performance and longer life for the engine.

NOTICE: Excessive heat build-up during the first three hours of operation will damage close-fitted engine parts. Do not operate at full throttle or high speeds for extended periods during the first three hours of use.

AIR FILTER

A clogged air filter can restrict air flow to the engine which can lead to reduced engine performance and shortened engine life.

BRAKE PADS

Brake pads should be checked for wear and oil or grease (petroleum products) contamination. Brake discs should be checked for cracks, excessive corrosion or warping.

HALF SHAFTS

Check for tears and punctures in the boot, which can lead to CV joint wear that can contribute to axle failure.

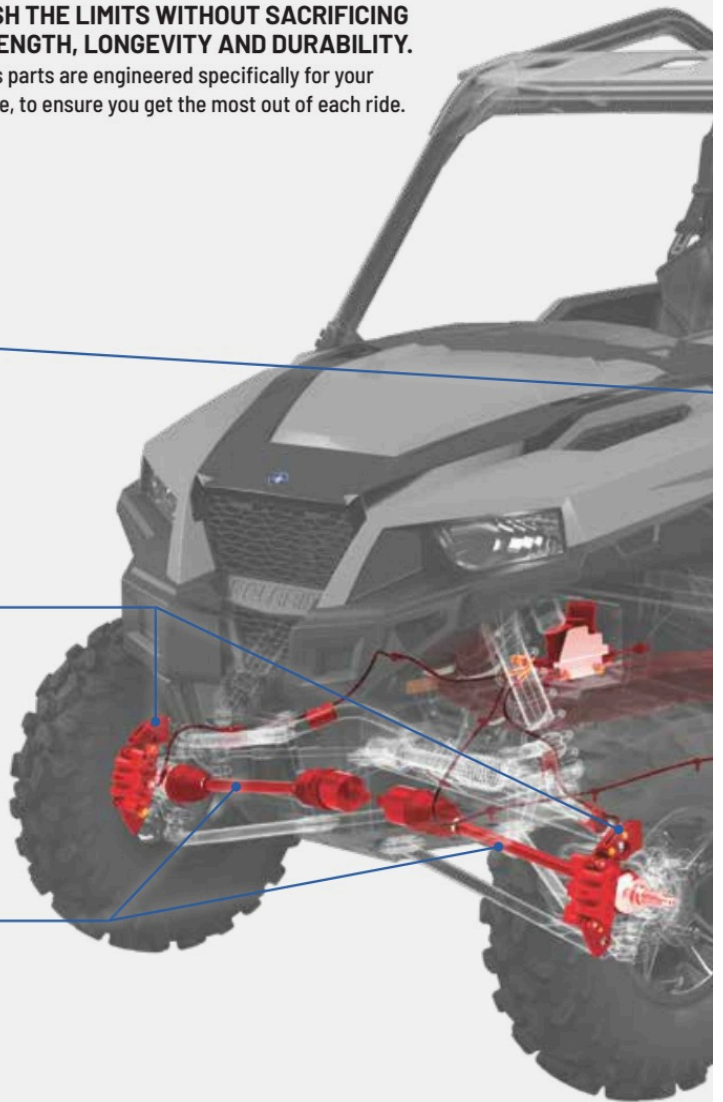

MAINTENANCE SCHEDULE*

BREAK-IN MAINTENANCE

FIRST 25 HRS / 1 MONTH | 250 MI / 400 KM

ENGINE OIL & OIL FILTER
CHANGE

GENERAL LUBRICATION
ALL FITTINGS, PIVOTS, CABLES, ETC.

AIR FILTER
INSPECT & REPLACE AS NEEDED

EXHAUST SYSTEM
INSPECT & CLEAN
INSPECT FOR LEAKAGE OR CARBON BUILD UP AT JOINTS
INSPECT & CLEAN SCREEN
TYPE SPARK ARRESTOR

6 MONTHS

50 HRS | 500 MI / 800 KM

EXHAUST SYSTEM
INSPECT & CLEAN
INSPECT FOR LEAKAGE OR CARBON BUILD UP AT JOINTS
INSPECT & CLEAN SCREEN
TYPE SPARK ARRESTOR

GENERAL LUBRICATION
ALL FITTINGS, PIVOTS, CABLES, ETC.

DRIVE BELT
INSPECT & ADJUST
REPLACE AS NEEDED

12 MONTHS

100 HRS | 1,000 MI / 1,600 KM

ENGINE OIL & OIL FILTER
CHANGE

DRIVE BELT
INSPECT & ADJUST
REPLACE AS NEEDED

TRANSMISSION FLUID
CHANGE

AIR FILTER
INSPECT & REPLACE AS NEEDED

EXHAUST SYSTEM
INSPECT & CLEAN
INSPECT FOR LEAKAGE OR CARBON BUILD UP AT JOINTS
INSPECT & CLEAN SCREEN
TYPE SPARK ARRESTOR

18 MONTHS

150 HRS | 1,500 MI / 2,400 KM

ENGINE OIL & OIL FILTER
CHANGE

BATTERY
TEST, CLEAN & CHECK FLUID LEVEL
REPLACE AS NEEDED

DRIVE BELT
INSPECT & ADJUST
REPLACE AS NEEDED

TIRES
INSPECT CONDITION & PRESSURE
REPLACE AS NEEDED

EXHAUST SYSTEM
INSPECT & CLEAN
INSPECT FOR LEAKAGE OR CARBON BUILD UP AT JOINTS
INSPECT & CLEAN SCREEN
TYPE SPARK ARRESTOR

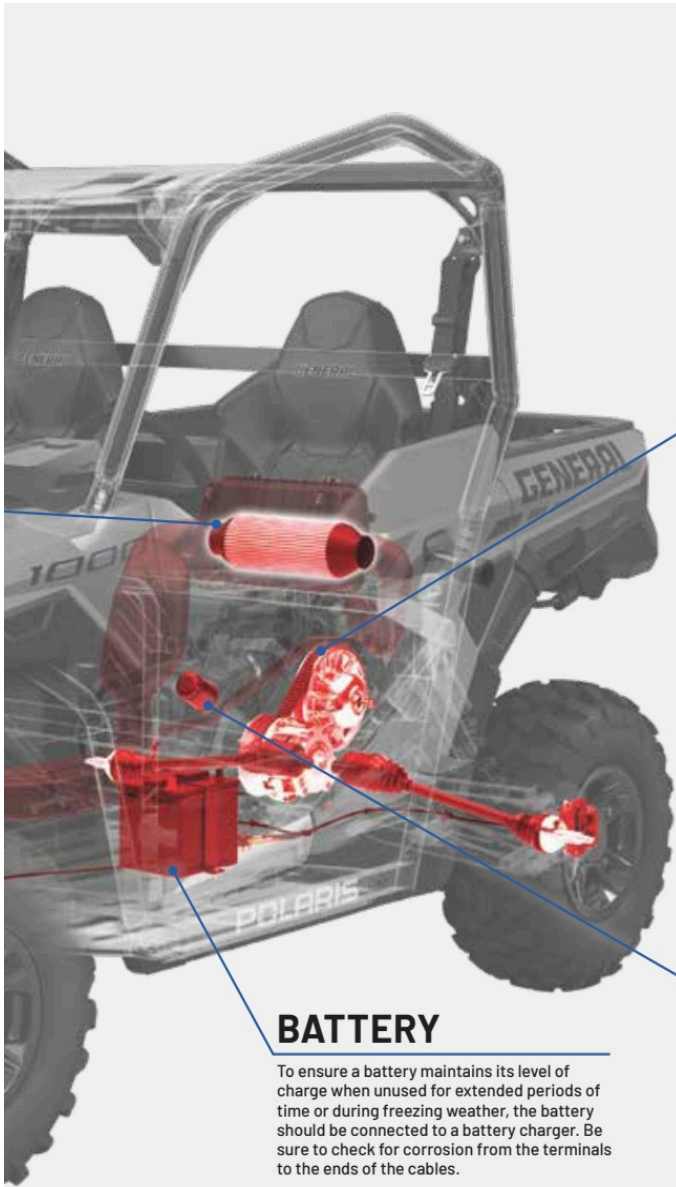

DRIVE BELT

Polaris Engineered belts deliver unmatched performance for your off-road vehicle. Developed and tested on all our engines for all environments and conditions. Check your belt for delamination, hour glassing and glazing.

OUR INVESTMENT

- 64,000+ km of field testing
- Thousands of dyno hours
- 18+ months of development (13,000+ design hours) per belt
- 1,500+ vehicle validation hours
- Collaboration with powertrain and clutch engineers

YOUR ADVANTAGE

- No clutch recalibration
- Less wear and tear due to heat
- Ensure maximum vehicle performance
- More time riding, less time wrenching
- Produced in collaboration with powertrain and clutch engineers to ensure a perfect fit, maximum performance and ultimate durability

BREAK-IN PERIOD

- Use lower gear (if available) while varying speeds and avoid wide open throttle for 8-16 km
- If no low gear is available, vary at moderate speeds while avoiding wide open throttle for 80 km

BATTERY

To ensure a battery maintains its level of charge when unused for extended periods of time or during freezing weather, the battery should be connected to a battery charger. Be sure to check for corrosion from the terminals to the ends of the cables.

OIL FILTER

Change oil filters with every oil change to provide the best engine protection and keep the engine operating at peak performance.

FOLLOW RECOMMENDED SERVICE INTERVALS IN THE OWNER'S MANUAL

24 MONTHS

200 HRS | 2,000 MI / 3,200 KM

ENGINE OIL & OIL FILTER
CHANGE

BRAKE PADS & FLUID
INSPECT & CLEAN
REPLACE BRAKE FLUID
REPLACE AS NEEDED

SPARK PLUGS
INSPECT
REPLACE AS NEEDED

AIR FILTER
INSPECT & REPLACE AS NEEDED

EXHAUST SYSTEM
INSPECT & CLEAN
INSPECT FOR LEAKAGE OR CARBON BUILD UP AT JOINTS
INSPECT & CLEAN SCREEN
TYPE SPARK ARRESTOR

30 MONTHS

250 HRS | 2,500 MI / 4,000 KM

ENGINE OIL & OIL FILTER
CHANGE

BATTERY
TEST, CLEAN & CHECK FLUID LEVEL
REPLACE AS NEEDED

DRIVE BELT
INSPECT & ADJUST
REPLACE AS NEEDED

GENERAL LUBRICATION
ALL FITTINGS, PIVOTS, CABLES, ETC.

EXHAUST SYSTEM
INSPECT & CLEAN
INSPECT FOR LEAKAGE OR CARBON BUILD UP AT JOINTS
INSPECT & CLEAN SCREEN
TYPE SPARK ARRESTOR

36 MONTHS

300 HRS | 3,000 MI / 4,800 KM

ENGINE OIL & OIL FILTER
CHANGE

AIR FILTER
INSPECT & REPLACE AS NEEDED

TRANSMISSION & GEARCASE
REPLACE FLUIDS

EXHAUST SYSTEM
INSPECT & CLEAN
INSPECT FOR LEAKAGE OR CARBON BUILD UP AT JOINTS
INSPECT & CLEAN SCREEN
TYPE SPARK ARRESTOR

FOR A COMPLETE MAINTENANCE SCHEDULE, CHECK YOUR OWNER'S MANUAL

*This is a sample maintenance schedule and is not intended for use in your specific vehicle. Please reference and use your owners manual to ensure proper maintenance and vehicle care.

OIL

PS-4 FORMULATIONS BEST PROTECTION, BEST PERFORMANCE

Our PS-4 engine oils provide ultimate performance and protection, they're formulated with exclusive additives to keep engines clean from deposit buildup. These powersports-grade full synthetic oils help maximize power and protect your engine for the long term.

PS-4 5W-50 FULL-SYNTHETIC OIL

Optimal for ambient operating temperatures of -40° C to 38° C

1L	4L	25L	60L	200L
502484	502485	502486	502487	502488

PS-4 0W-50 **EXTREME** FULL-SYNTHETIC OIL

Optimal for ambient operating temperatures of -43° C to 54° C.

1L	4L	25L	60L	200L
503220	503221	503233	503236	503235

PS-4 5W-50

OIL CHANGE KITS

These convenient kits include everything needed including filter and oil volume per vehicle

PART NUMBER	VEHICLE FITMENT
502541	SINGLE 570, TWIN 600, TWIN 700, TWIN 800
502543	RANGER/RZR 900/1000
502542	SPORTSMAN 550/850/1000

POLARIS INVESTS IN EACH OIL AT & ABOVE THESE LEVELS

**12+ DEDICATED
TEAM MEMBERS**
FOCUSED ON POLARIS OIL

**18+
MONTHS**
DEVELOPMENT & TESTING

**76,000+
HOURS**
DYNO TESTING

**3.5 MILLION+
KILOMETERS**
FIELD TESTING



POLARIS
EXTREME
SYNTHETICS

PS-4 EXTREME SYNTHETIC 0W-50

- Our best extreme high and low temp formula, excellent for high temperatures and racing, even at temps of 54°C, plus easier cold starting even below -42°C
- Expect the best in wear protection thanks to premium PAO and ester base stocks combined with a balance of moly and ZDDP additives
- Polaris exclusive clean engine additive system reduces deposits and carbon build-up for peak performance and power

THE BEST PROTECTION, MAXIMUM PERFORMANCE

- Powersports grade full synthetics provide long lasting engine protection
- At least 40% improved wear protection compared to all aftermarket oils tested (see engine wear test chart)
- Polaris exclusive clean additive system
- At least 50% less deposits than all aftermarket oils tested (see deposit test chart)
- Cleaner engine with less deposits means consistent maximum power and performance

WIDEST VISCOSITY FOR ULTIMATE PROTECTION



ENGINE WEAR TEST

LOWER NUMBER = LESS ENGINE COMPONENT WEAR
LESS WEAR ON PARTS MEANS LONGER ENGINE LIFE

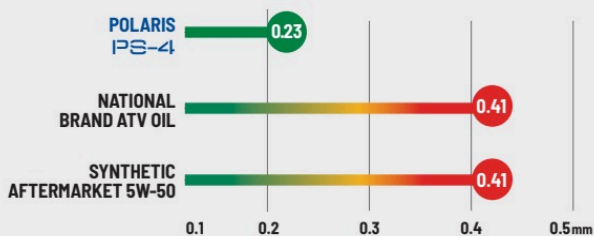

ASTM D4172. In 3rd party testing against 9 competitive products Polaris had 40% or better wear protection compared to all of the tested products. Numbers represent mm of wear scarring measured. Test measures wear at contact points, wear scar is measured for its length and width (in units of mm). Lower wear numbers mean better wear protection and friction reduction.

DEPOSIT TEST

LOWER DEPOSITS = MAXIMUM POWER

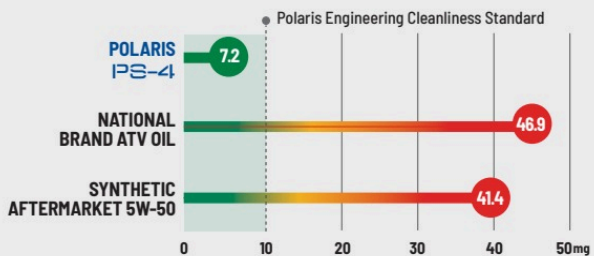

ASTM D6335. In 3rd party testing against 9 competitive products Polaris PS-4 had less than half the deposits compared to the next closest product. No other tested products met Polaris Engineering standards for deposit cleanliness. Test measures mass of deposits in mg in high temp, high stress test cycles. Higher deposits will impact engine power and performance.

MAINTENANCE FLUIDS



ENGINE OIL

Maximum protection for your 4-cycle engine.

Change every 100 hours, 6 months or 800 km.

» SEE P. 46



AGL

Protects transmission components against wear, corrosion, oxidation and foam in transmissions. Unique viscosity provides all-season performance including cold flow protection.

Change every 100 hours, 12 months or 1,600 km.

- » 1 L • 502505
- » 25 L • 502507
- » 200 L • 502508



PREMIUM GAS SHOCK OIL

- » 1 L • 502518



ALL-SEASON GREASE TUBE

Specialized water-resistant lubricant

- » 400 g • 502538



ANGLE DRIVE FLUID 80W/140

Provides maximum protection in high-torque/ high-pressure conditions. Reduces wear, corrosion and oxidation in rear angle drives

- » 1 L • 503320
- » 25 L • 503318
- » 202 L • 503317

SPORTSMAN, RANGER, RZR
ANGLE DRIVE GEAR CASE SYSTEMS

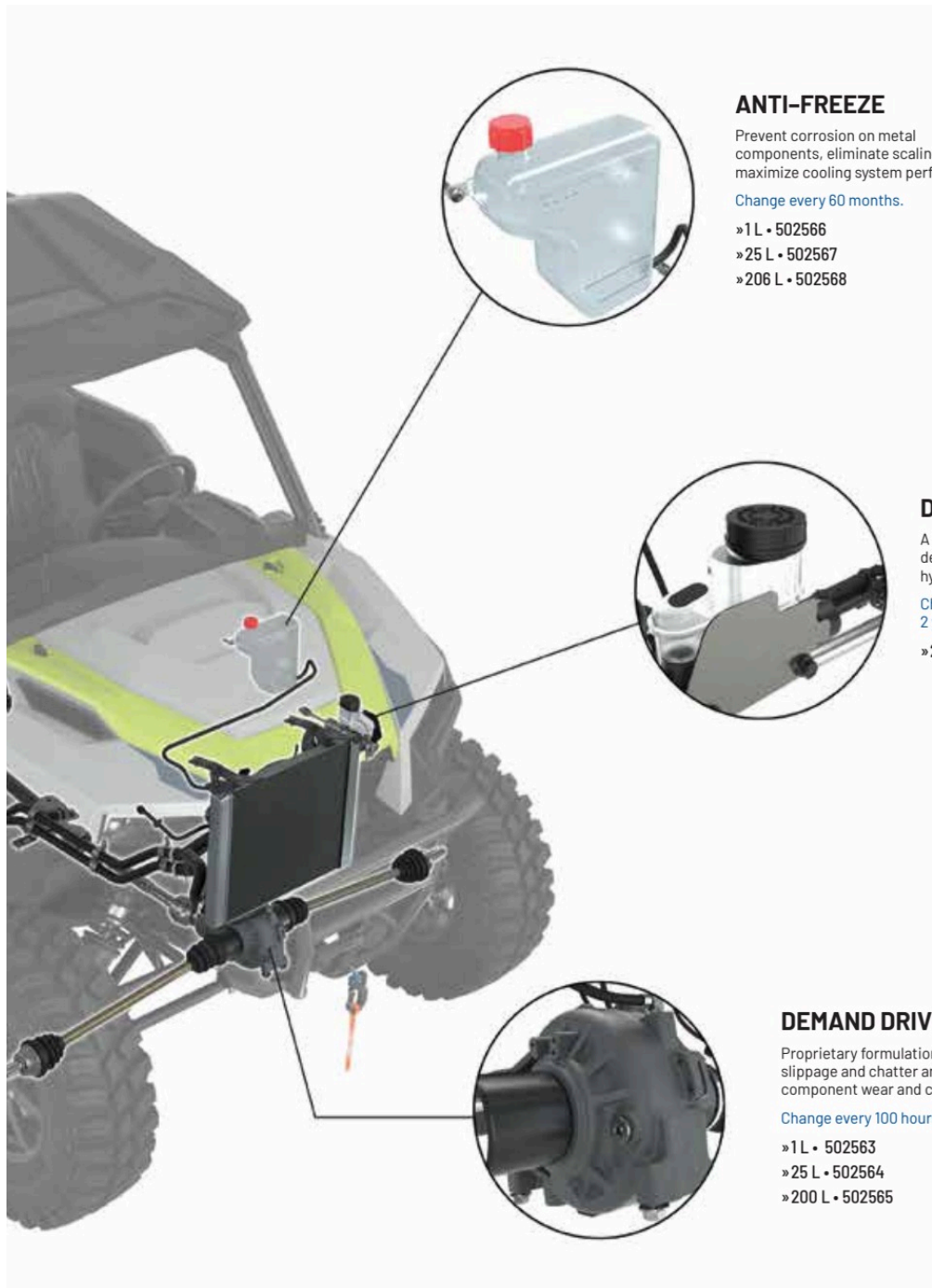

ANTI-FREEZE

Prevent corrosion on metal components, eliminate scaling and maximize cooling system performance.

Change every 60 months.

- » 1 L • 502566
- » 25 L • 502567
- » 206 L • 502568



DOT 4 BRAKE FLUID

A high-quality brake fluid designed for use in Polaris hydraulic brakes.

Change every 200 hours, 2 years or 3,200 km.

- » 250 ML • 502526



DEMAND DRIVE FLUID

Proprietary formulation prevents clutch slippage and chatter and reduces component wear and corrosion.

Change every 100 hours or yearly.

- » 1 L • 502563
- » 25 L • 502564
- » 200 L • 502565



CARBON CLEAN

Ultimate fuel and injection system cleaner

- » 125 mL • 502528



FUEL STABILIZER

Fuel Stabilizer prevents ethanol corrosion and stabilizes fuel for up to 2 years. Dual-antioxidant formula protects against gum and varnish for easy starting.

- » 125 mL • 502519

HD HEAVY DUTY PARTS

All Polaris parts are developed and tested to help you get the most out of your ride. We're taking the passion of our riders, workers and outdoor enthusiasts to the next level with HD Parts.

Engineered and designed for:

- Greater durability
- Enhanced performance
- Greater wear and tear capabilities
- All weather conditions



DRIVE BELTS

The enhanced rubber material compound in these belts keep them cool in extreme heat, while our patented cord treatment process maximizes the transfer of horsepower to the ground for those customers hauling heavy loads.

OE	HD	HEAVY DUTY PARTS
3211149		
3211169	3212326	
3211196		
3211113	3212328	



OIL FILTERS

The advanced synthetic material built into these filters offers the highest debris holding capacity, maintains oil flow and maximizes performance.

OE	HD	HEAVY DUTY PARTS
2540086	2522485	



NEW BATTERY*

AGM fully sealed for optimal starting power with maximum reserve capacity, designed for highly accessorized vehicles and extreme operating conditions.

OE	HD	HEAVY DUTY PARTS
4014132	4081855	

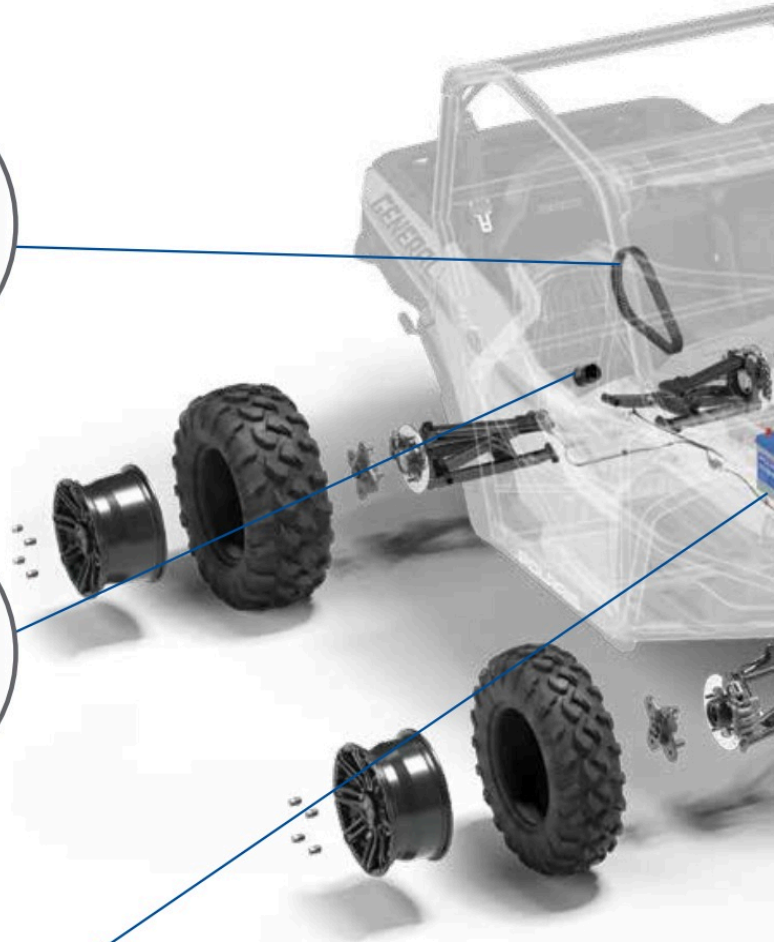

*Check with your local dealer for availability.

Claims made based off testing and performance of Polaris HD Parts against standard OEM parts made by Polaris and competitor brands under normal use.



WHEELS & TIRES

Class leading durability for off-road performance and traction for confident driving in extreme conditions.

- » 1524022-458 • HD WHEEL - 14x7*
 - » 5417507 • PRO ARMOR HD-K - 29x10R14*
 - » 5457498-458 • HD WHEEL CENTER CAP*
 - » 5415756 • PRO ARMOR XD-K FRONT
 - » 5415757 • PRO ARMOR XD-K REAR
- * Shown

WHEEL BEARINGS

Fully sealed for added protection against intrusions. Made of a higher grade steel for extended life in extreme conditions.

LOCATION	OE	HD
FRONT		
REAR	3514924	3515090

CV BOOT KIT

TPE rubber compound for maximum puncture and tear resistance, includes (1) boot, grease and clamp to replace OE stock part. Provides increased durability for riding in extreme conditions.

OE	HD
3236165	2209923

BRAKE PADS

Engineered to provide longer life and better stopping power while riding in extreme conditions.

OE	HD
2205949	2208933
2203318	2208936

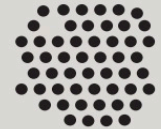

SAND



MUD



WATER



EXTREME COLD



EXTREME HEAT UP TO 54° C



HEAVY PAYLOADS



EXTENDED LIFE

SERVICE PARTS

**POLARIS ENGINEERED SERVICE PARTS
DELIVER UNMATCHED PERFORMANCE AND
FIT FOR YOUR OFF-ROAD VEHICLE.**

All service parts are engineered specifically for your machine. Which means everything is designed, tested and perfected to maximize the life of your ride. Getting Polaris Engineered parts is a decision that pays off in the long run, because it ensures there is a long run.

**VISIT YOUR POLARIS DEALER
TO SHOP FOR SERVICE PARTS.**

OVER
100,000
PARTS
AVAILABLE!



FOR THE LIFE OF YOUR RIDE

Maintenance is the key to keeping your Polaris off-road vehicle performing at its peak. Items like belts, lubricants, and batteries represent only a few of these critical items engineered specifically by Polaris.



POLARIS ENGINEERED DRIVE BELTS

TESTED, PERFECTED

We test each belt on the intended vehicle – we don't just try to make an existing belt "just work".

– Amery Kuhl, Polaris CVT System Engineer

OUR INVESTMENT

- 32,187 km of field testing
- Thousands of dyno hours
- 18+ months of development (3,000+ design hours) per belt
- 1,200+ vehicle validation hours
- Collaboration with powertrain & clutch engineers

YOUR ADVANTAGE

- No clutch recalibration
- Less wear & tear due to heat
- Ensure maximum performance of your vehicle
- More time out riding, less time wrenching

**OUR INVESTMENTS ENSURE POLARIS BELTS
OUTPERFORM YOUR EXPECTATIONS.**

KEEP IT CLEAN

CLEAN

ALL-PURPOSE CLEANER

- Professional cleaner, which is formulated with a low pH-value. The product spreads well on surfaces and adheres on them for effective cleaning action. Perfectly compatible with rubber, plastic and painted surfaces. The formulation is biodegradable.

» 500 mL • 502309

SHINE

INSTANT SHINE & DETAILER

- The INSTANT SHINE AND DETAILER is developed for cleaning action without water. Removes insects, dust and dirt with almost no effort. Applicable for plastics, visors, windcreens, paint and metal. The wipe and shine formulation makes surfaces shine, works water repellent and also has an antistatic effect. Perfect for customers living in urban areas with no access to water, for bike trips or showroom bikes.

» 500 mL • 502546



BRING IT EVERYWHERE

TRAILERING



CALIBER RAMP PRO

- Designed for ATVs and UTVs up to 127 cm wide
- Integrated grip glides for ultimate traction
- Folding sides for easy transportation and storing

» 132 cm x 229 cm • 2884576



ALUMINUM ARCHED LOADING RAMPS

- Capacity for up to 1,361 kg, 680.7 kg per ramp
- » 193 cm x 30.5 cm • 907 kg • 2875384
- » 224 cm x 30.5 cm • 1,361 kg • 2875386



LIGHTWEIGHT TRI-FOLD RAMPS

- Ramp folds up for transport
- Capacity for up to 680.7 kg
- Safety straps included
- » 183 cm x 130 cm • 2875385
- » 208 cm x 130 cm • 2875860

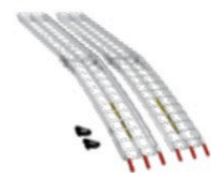

FOLDING ALUMINUM ARCHED RAMPS

- Ramp folds up for transport
- Up to 680 kg total capacity, 340 kg per individual ramp
- Safety straps included
- » 224 cm x 30.5 cm • 2875387

COVERS



TRAILERABLE COVER BY POLARIS

- » 2-SEAT • 2881841
GENERAL XP 1000 '20-24
GENERAL 1000 '16-24
- » 4-SEAT • 2881787
GENERAL XP 4 1000 '20-24
GENERAL 4 1000 '17-24



POLARIS SxS CAMO FIELD COVER

- » 2882160
GENERAL XP 1000/4 '20-24
GENERAL 1000/4 '16-24

CV BOOT REPAIR KIT*

FIX ON THE GO | TEMPORARY COVERAGE

- A quick trail-side fix to increase trail time
- The flexible and durable boot material expands over a cone tool for CV boot repairs, without disassembling CV axles
- Universal fit – works as a temporary fix for most powersports axles
- All components fit inside the cone, and a cover is provided for compact durable storage
- Easily fits in a cargo box, attached to the roll cage, in the glovebox or many other storage locations



Items shown are contained inside cone

UTV CV BOOT REPAIR KIT

Kit includes the following items:

- (1) Expandable XL CV Boot
 - (1) Reusable Cone Tool
 - (2) CV Boot Clamps
 - (1) Tube of Silicone Lube
 - (1) Grease Packet
 - (1) Cone Cover
- » 2830526

UTV TRAIL BOOT ONLY

» 2830527

ATV

» CV REPAIR KIT 2830528
» TRAIL BOOT ONLY 2830529

HOW TO INSTALL

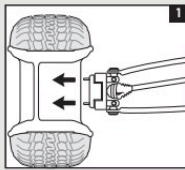

Remove wheel and axle nut.

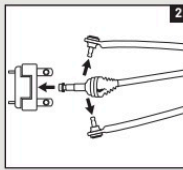

Remove brake caliper, hub, tie rod and upper and lower ball joints.

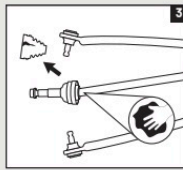

Remove old boot and clean joint.

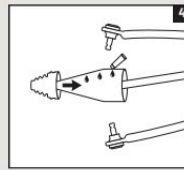

Spread silicone lube on entire cone tool. Slide boot over cone tool, large end first. See package for outer boot instructions.

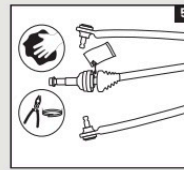

Empty the bag of grease into the CV joint/boot, clean sealing points and install clamps.

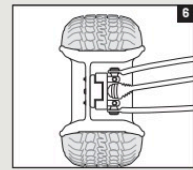

Reassemble tie rod, ball joints, brake caliper, axle nut, tire and wheel.

Refer to your service manual for further instructions and torque specifications.
*Designed for temporary CV boot repair. Purchase the OEM CV Boot for a permanent repair.

HITCHES



HITCH WITH 5 cm BALL

- 3:1 Hitch: ball, hook and pin design
 - Rust resistant steel with powdercoat finish
 - Removable ball, HD 1.6 cm pin and clip
- » 5 cm x 5 cm RECEIVER • 2830522
» 3 cm x 3 cm RECEIVER • 2830523



4.8 cm BALL

- 4.8 cm replacement ball for hitch
 - Designed to work with 3:1 Hitch
- » 2830524



RECEIVER HITCH

» 5 cm RECEIVER TONGUE 2875320



TRAILER BALL 1.9 cm SHANK

» 4.8 cm BALL • 2877602
» 5 cm BALL • 2877603

STRAPS & ROPES



RECOVERY STRAP

- 5 cm x 9.1 m
 - 8,165 kg maximum load / 4,082 kg maximum vehicle weight
 - Comes with carry bag
- » 2884033



RATCHET STRAP

- 3.8 cm x 4.6 m straps, 2 Pack
 - Heavy duty webbing
 - 2,495 kg maximum load, 831 kg working load
- » 2884031



RATCHET STRAP

- 5 cm x 6.1 m Ratchet Straps
 - Heavy duty webbing, floating D-rings, double J-hooks
 - 4,536 kg maximum load, 1,497 kg working load
- » 2884032



SHOCK STRAPS

- 3.8 cm, 1,361 kg breaking strength
 - Keeps tension on tie-down straps to secure load, 2 pack
- » 3.8 cm x 4.6 m • 2883296
» 3.8 cm x 2.1 m • 2883295



APPAREL

FIT FOR ANY ADVENTURE. For outdoor enthusiasts looking for gear that's purposefully built to stand up to the fun and challenging experiences Polaris vehicles enable. Each piece of apparel and equipment bearing the name Polaris is crafted by outdoor enthusiasts, for outdoor enthusiasts. They are a badge of honor – representing what the Polaris brand stands for – a passion to simply be outside doing what you love.



APPAREL

RACING COLLECTION

JERSEYS & GLOVES
& HEATED APPAREL

HELMETS & GOGGLES

MEN'S APPAREL

BALL CAPS & BEANIES

WOMEN'S APPAREL

HOME & COLLECTIBLES

RACING COLLECTION



HELMET

- Polycarbonate shell
- Removable & washable lining
- Double lens system with integrated sun visor
- Quick release micrometric adjustment system

NEW Black Matte | XS-2XL | 2802408
 White Gloss | XS-2XL | 2802311
 Dark Gray Matte | XS-2XL | 2802312

ECE22.06



- Weight: 1450 g (+/-50 g)
- 1 shell and 2 EPS: XS-M, L-XXL
- ECE 22-06 approved



BOOTS

- Waterproof and breathable lining
- Full-grain oil treated leather upper
- Specific ATV double density compound rubber sole
- Adjustable Velcro® closure
- Replaceable/adjustable plastic buckles
- Anti-bacterial replaceable footbed
- CE-approved motorcycle boots EN 13634:2017

Black | EU39 - 47 | 2802313
 Brown | EU39 - 47 | 2802314



NEW SPORT JACKET

- Light and water repellent jacket
- Ideal for ATV and SxS ride in wet weather
- 2 zipped pockets on the outside and 2 inside pockets
- Laser cut under the arms for better ventilation

Black | XS-4XL | 2802409



NEW SPORT PANTS

- Light and water repellent pant
- Ideal for ATV and SxS in wet weather
- Ergonomic cut and stretch to gain comfort
- 1 zipped pocket
- Belt adjustment with micrometric buckle

Black | XS-4XL | 2802410



NEW TECHNICAL SHIRT

- 100% polyester
- Indelible sublimated graphics
- Hemmed edging
- Lycra cuffs and collar

Men's | Black | S-3XL | 2802404
 Women's | White | S-2XL | 2802405



SAFETY GLOVES TOUCH



- CE-approved motorcycle glove EN 13594:2015
- Touch screen compatible
- Silicon print on fingers to improve grip
- Neoprene cuff with Velcro® tightening
- Reinforcements patches for safety and comfort

Khaki | S-3XL | 2802309
 Black | XS-7, 3XL-13 | 2802103



NEO GLOVES



- CE-approved motorcycle glove EN 13594:2015
- 100% synthetic neoprene glove
- Touch screen compatible
- Knuckle protected
- Reinforcements patches for safety and comfort

Black | XS-7, 3XL-13 | 2802310



SF TECH GLOVES TOUCH



- CE-approved motorcycle glove EN 13594:2015
- Touch screen compatible
- Knuckle-protected
- Silicon print on fingers to improve grip
- Neoprene cuff with Velcro® tightening
- Reinforcements patches for safety and comfort

Khaki | S-3XL | 2802308
 Black | XS-7, 3XL-13 | 2802102



TECHNICAL JACKET

- Water-resistant jacket
- Ultra-light thanks to polyester ripstop and softshell for optimal comfort
- Ventilated lining
- Hydration hose outlet
- Zip ventilation system on body and back

Black | S-3XL | 2802301



TECHNICAL PANTS

- Water-resistant pants
- Ultra-light thanks to polyester ripstop, softshell and 1000-D Cordura stretch fabric on the back for optimal comfort
- 2 cargo type pockets
- Zip ventilation system
- Zip and Velcro® adjustment at the bottom of the pants

Black | S-3XL | 2802302



NEW WATERPROOF JACKET

- 100% polyester 2,5 Layer stretch fabrics
- PU membrane waterproof and breathable 3000 mm / 3000 gr
- All seams taped and WR main zipper
- Adjustable hood
- Ventilation system on back to improve ventilation

Black | S-3XL | 2802403



PUFFY JACKET

- Top body and shoulder polyester woven 3000 mm/3000 gr + welded quilting
- Lower body nylon 380T downproof
- 80gr padding
- Inner elastic bottom tightening
- Two external pockets with easy-grab puller

Black | S-3XL | 2802303



PADDED JACKET

- Shoulder and hood softshell waterproof and breathable 3000 mm/3000 gr
- Lower body and sleeve, polyester woven waterproof and breathable 3000 mm/3000 gr
- Quilted lining with 80 gr padding
- Elasticized lower body tightening
- Two external pockets with easy-grab puller

Black | S-3XL | 2802306



RACING PARKA

- Waterproof and breathable 3000 mm/3000 gr
- Quilted lining with 80 gr padding
- 2 upper body outer pockets and 2 bottom cargo pockets
- Sleeve pocket with lazer holes
- +TPU welded film on zipper

Black | S-3XL | 2802307



BODYWARMER

- Upper body and side panels in softshell waterproof and breathable 3000 mm/3000 g
- Lower body nylon downproof
- Padding 80 g
- Two external pockets with easy-grab puller

Khaki | S-3XL | 2802304
Black | S-3XL | 2802101



RACING SOFTSHELL

- Softshell waterproof and breathable 3000 mm/3000 g
- Removable hood
- Four external pockets with easy-grab puller

NEW Women's | Black | S-XL | 2802402
Men's | Khaki | S-3XL | 2802305
Men's | Black | S-3XL | 2802003



HYBRID JACKET

- Sleeves in softshell waterproof and breathable 3000 mm/3000 g
- Body nylon downproof
- Padding 80 g
- Three external pockets with easy-grab puller

NEW Khaki | S-3XL | 2802401
Black | S-3XL | 2802004

JERSEYS & GLOVES



OFF-ROAD RIDING JERSEYS

Mesh ventilated panels for maximum airflow.
Elastic sleeves with non-restrictive cuffs.

OFF-ROAD RIDING GLOVES

Adjustable wrist closure for a custom fit.
Silicon finger grips and neoprene knuckle protection.
Gloves are not CE-approved.



	SIZE	 N/A	 N/A				
		A RED	B LIME/OLIVE	C BLACK	D ORANGE	E TEAL	F BLUE
ADULT JERSEY	S-3XL	2864637	2864638	2862718	2862719	2862720	2862722
GLOVES	S-3XL	2864635	2864636	2862726	2862729	2862727	2862728
YOUTH JERSEY	S-XL	2864639	N/A	2862723	N/A	2862724	2862725



NECK GAITERS

Keep the sun off your neck and the dust off your face.
Stretchy and seamless material that is UPF 15-18 for sun protection and moisture-wicking.

- Blue | 2833138
- Camo | 2861948
- Black | 2861953
- Red Retro | 2861950
- Lime | 2861952

HEATED APPAREL

Keep warm even on the coldest days with Polaris Heated Apparel. By keeping the heat close to your body, you can stay out for a longer, more comfortable ride. The Polaris Heated Apparel lineup includes the Heated Vest, Heated Base Layers and a Heated Glove Liner for both men and women. Easily control your heat setting with the touch of a button.



WOMEN'S
Black | 2833036



MEN'S
Black | 2833022

HEATING ELEMENTS



UNISEX
Black | 2833044

HEATED VESTS

WARMTH WITH THE TOUCH OF A BUTTON

S-3XL

- Perfect for any outdoor activity
- Down-proof machine washable material with 160g of insulation for warmth with or without the heater turned on
- Powered by a small rechargeable battery (included) that can also be used to charge a cellphone; battery not machine washable, remove prior to washing
- Easily adjust between four heat settings for changing weather conditions with built-in buttons

HEATED GLOVE LINER

KEEP YOUR HANDS WARM ON FROSTY DAYS

S-3XL

- Designed to fit under all Polaris riding gloves for an extra layer of warmth to keep you out riding longer
- Easily adjust your heat level by pressing a button on the bottom part of the glove



HEATING ELEMENTS

WOMEN'S
Top | 2833033
Bottom | 2833034

MEN'S
Top | 2833031
Bottom | 2833032

HEATED BASE LAYERS

ADJUSTABLE HEAT CLOSE TO YOUR BODY, MAXIMUM COMFORT IN CHANGING CONDITIONS

S-3XL

- Intended for use as a base layer
- Features lightweight, moisture-wicking fabric to give you the most comfortable layering to wear on all of your cold weather adventures, on or off the trail
- Includes multiple heat panels for evenly distributed heat for maximum warmth and comfort
- Powered by a small rechargeable battery (included) that can be used to charge a cellphone; battery not machine washable, remove prior to washing
- Easily adjust between four heat settings for changing weather conditions with built-in buttons

HEATED APPAREL REPLACEMENT BATTERY PACK

- Compatible with Polaris Heated Base Layer Tops, Bottoms & Vests
- Includes: 7.4V Lithium-Ion Battery with two 7.8V chargers (110V wall and 12V port)

2864582



HEATED GLOVE LINER REPLACEMENT BATTERY PACK

- Compatible with Polaris Heated Glove Liners
- Includes: two 7.4V Lithium-Ion Batteries, one 100-240V charger

2864583



HELMETS



CARBON FIBER
BLACK
S-2XL | 2833158

509 FOR POLARIS FIDLOCK. IGNITE

DELTA V COMMANDER

NO LONGER A HELMET, IT'S A COCKPIT

SHELL

- Carbon fiber
- Lightweight polycarbonate

WEIGHT

- Up to 1,832 g

FEATURES

- The Delta V Commander features an integrated communication system, infinity style sealed IGNITE heated shield, and ergonomic design
- Features in-helmet JBL® speakers for audio and an integrated microphone to connect up to 14 users in a group with the best sound and noise cancellation for all your rides
- Venturi Vent Ducting, an integrated spoiler, and low-profile antennae keeps this helmet sleek, quiet, and fog-free all day on the trails
- 12-volt power input on left side powers shield, comms, and chase light with controls for bright, normal, and off positions
- Battery power for up to 10 hours of riding
- Connect via Bluetooth® to your music, phone, maps, and sled
- DOT/ECE 22.06 dual certified helmet shell and luxurious liner
- Fidlock® chinstrap for easy on and off



CARBON FIBER
WHITE
2833152

509 FOR POLARIS FIDLOCK. IGNITE

DELTA V CARBON IGNITE

BUILT SPECIFICALLY FOR SUSTAINED LONG RIDES,
AT SPEED, IN COLD TEMPERATURES

S-3XL

SHELL

- Carbon fiber

WEIGHT

- Up to 1,807g

FEATURES

- Hand-laid carbon fiber construction for lightweight and durable performance
- Powered helmet – 12 volt power input on left side to power shield
- IGNITE heated shield is powered by your snowmobile's battery, and comes with all required connection cables
- Compatible with 509 12 volt power pack system, for 10 hours of riding
- Innovative Venturi Vent pulls moist air from helmet without cold wind coming into helmet
- 2 shell sizes, and dual density EPS for optimal fit
- Premium liner for a comfortable and quiet fit
- Ignite dual pane heated shield for fog-free performance
- DOT/ECE 22.06 dual certified helmet shell
- Fidlock® chinstrap for easy on and off



BLACK
S-3XL | 2833151



WHITE
S-3XL | 2833150



CARBON FIBER
BLACK
2833153



ORANGE/TAN
2864559

TENACITY 4.0

COMBINATION OF MODERN STYLE & PREMIUM PROTECTION WITH INCREDIBLE VALUE

XS-2XL

SHELL

- Shock-resistant, injection-molded thermoplastic

WEIGHT

- 1,500g

FEATURES

- Through-flow, full-helmet ventilation
- ProClip quick release chin strap allows you to fasten the chin strap in seconds
- Removable breath box and removable, washable liner
- Tool-less adjustable roost shield
- DOT- and ECE 22.06-approved



BLACK/LIME
2864560

RADIANT GREEN
2833142

BLACK
2861557

BLACK/GRAY
2861558

WHITE/RED
2861561

BLUE
2833143

GOGGLES



NEW
OLIVE/LIME
2864546

509 KINGPIN CE

PREMIUM MATERIALS, ATTRACTIVE PRICE

FEATURES

- Built for off-road, the oversized spherical lens delivers optimal peripheral vision
- Metal tear-off posts provide strength and durability
- Quick-change technology allows you to run the best lens tint for conditions



STEALTH
2862560



BLUE
2862562



NEW
ORANGE
2864545

509 MX6 CE

SUPER WIDE FIELD OF VIEW, ENGINEERED FOR DIRT

FEATURES

- PC outer lens with anti-scratch coating, and internal anti-fog coating
- Outriggers with latch system for quick lens change
- 45mm strap with silicone to hold strap in place



BLACK
2862557



RED/BLACK
2862558

APPAREL

RACING COLLECTION

JERSEYS & GLOVES
& HEATED APPAREL

HELMETS & GOGGLES

MENS APPAREL

BALL CAPS & BEANIES

WOMENS APPAREL

HOME & COLLECTIBLES

MEN'S APPAREL



BLUE
2864518



GRAY/RED
2833029



CYPRESS
2864517



CAMO
2861543



BLUE
2833028



BLACK
2861434

FORCE PUFFER JACKET

PACKABLE JACKET OFFERS LIGHTWEIGHT PROTECTION & INCREDIBLE WARMTH

S-3XL

- 140g 3M™ Thinsulate®
- Two external hand pockets, one internal media pocket
- Rugged YKK® zippers
- Compactable into travel pocket

SOFTSHELL JACKET

VERSATILE LIGHTWEIGHT JACKET THAT'S PERFECT FOR EVERYDAY WEAR

S-3XL

- Casual jacket armed with rugged and warm features for everyday wear
- Superior DWR prevents precipitation from saturating the jacket's exterior
- Lined with soft fleece for warmth
- Removable hood and underarm venting, three external pockets and one internal chest pocket



BLACK/GRAY
2864524



RED
2833026



BLUE/ORANGE
2862567



BLUE
2864525



BLACK/LIME
2833024



TAN
2862450

TITAN MID-LAYER

VERSATILE MID-LAYER CAN BE WORN ALONE OR AS AN EXTRA LAYER

S-3XL

- 319g Polartec™ Thermal Pro® Rib Sweater provides great warmth
- Breathable material moves sweat to the outer surface
- Nylon overlay is comfortable and light

NORTHSTAR MID-LAYER

EXTREMELY WARM YET BREATHABLE MID-LAYER, PERFECT FOR RIDING

S-3XL

- 280g of breathable fleece for added warmth
- Offers durable protection against the elements with a wear-resistant polyester face and wind-block layer on chest
- Designed to fit under outer shell when riding



BLACK
2862569

WORK VEST

RUGGED & DURABLE VEST THAT'S
IDEAL AS AN OUTDOOR LAYER S-3XL

- Made of durable nylon fabric to make it the ideal vest for work
- 80g 3M™ Thinsulate™ Insulation provides great warmth
- Vest comes with plenty of pockets to store your valuables



BLUE/GRAY
2864521

RED
2833030

BLACK/GRAY
2862565

CAMO
2862572

REVOLVE VEST

REVERSIBLE

DURABLE & WARM REVERSIBLE VEST
OFFERS TWO STYLES IN ONE S-3XL

- Durable windbreak outer fabric helps protect from the elements
- 140g 3M™ Thinsulate™ insulation keeps you warm in cold weather



LIGHT GRAY
2833110

GRAY
2862521

NAVY
2862523



CYPRESS
2864523

DARK BLUE
2864522

ORANGE
2833025

GRAY
2862576

BLUE
2861443

ADAPT QUARTER-ZIP

EXTRA LIGHT MID-LAYER WITH
A COMFORTABLE FIT S-3XL

- Versatile use both on and off the trail
- The polyester and spandex blend enables a flexible fit

TECH QUARTER-ZIP

FLEECE LINED MID-LAYER FOR ESSENTIAL WARMTH WHILE
RIDING WITH THE STYLE & COMFORT TO WEAR ANYWHERE S-3XL

- Fleece-lining keeps you cozy and warm
- Move freely with four-way stretch material
- Contoured, slim fit

MEN'S APPAREL



UPF HOODIE TEE

Blue | S-3XL | 2833072
 Gray | S-3XL | 2833073

ASCENT HOODIE

Black | S-3XL | 2864677
 Gray | S-3XL | 2864678
 Red | S-3XL | 2864679



CREW SWEATSHIRT

Green | S-3XL | 2864632
 Navy | S-3XL | 2864633
 Gray | S-3XL | 2833067
 Black | S-3XL | 2862488



JOURNEY HOODIE

Red | S-3XL | 2864535
 Cypress | S-3XL | 2864536
 Black | S-3XL | 2862489



STAPLE HOODIE

Blue | S-3XL | 2864605
 Black | S-3XL | 2833068
 Green | S-3XL | 2833070



TECH FULL-ZIP HOODIE

Blue | S-3XL | 2864531
 Gray | S-3XL | 2861493



ROGUE HOODIE

Blue | S-3XL | 2864587
 Black | S-3XL | 2833062
 Navy | S-3XL | 2833063



PLAID FLANNEL SHIRT

Blue | S-3XL | 2864671
 Cypress | S-3XL | 2864672



BACK

ADVENTURE LONG SLEEVE

Gray | S-3XL | 2833089
Black | S-3XL | 2833090



ICON EDGE LONG SLEEVE

Gray | S-3XL | 2864682
Blue | S-3XL | 2864683



BACK

PERFORMANCE LONG SLEEVE

Gray/White | S-3XL | 2833324
Red | S-3XL | 2864600
Royal Blue | S-3XL | 2833325
Gray | S-3XL | 2833168
Black | S-3XL | 2862507



ICON LONG SLEEVE

Blue | S-3XL | 2864591
Navy | S-3XL | 2864590
Lime | S-3XL | 2833083
Black | S-3XL | 2861584



BACK

GRAPHIC TEE

Heather Gray | S-3XL | 2864612
Dark Gray | S-3XL | 2833086
Forest Green | S-3XL | 2833087



FLAG TEE

Navy | S-3XL | 2862500
White | S-3XL | 2862582



HALF DOME TEE

Black | S-3XL | 2864616
Olive | S-3XL | 2864617
Navy | S-3XL | 2864618



PEAK GRAPHIC TEE

Blue | S-3XL | 2864684
Black | S-3XL | 2864685



ASCENT TEE

Olive | S-3XL | 2864680
Navy | S-3XL | 2864681

BALL CAPS



HALF DOME PATCH CAP

Black | 2864576
Tan | 2864577



METAL BADGE PANEL CAP

Cypress | 2864574
Black | 2864575



HEX PATCH COOLING CAP

Black | 2864571
Blue | 2864572
Gray | 2864573



ELLIPSE PATCH TRUCKER HAT

Purple | 2864563
Cypress | 2864562
Gray | 2833498
Black | 2833500
Navy | 2833499
Orange | 2833124



STAPLE CAP

Cypress | 2864568
Black | 2833127
Navy | 2833128



TONAL HAT

Orange | 2864564
Black/Red | 2833497
Navy | 2833496



JOURNEY CAP

Light Blue | 2864570
Black | 2833136
Blue | 2833137



LEATHER PATCH HAT

Cypress | 2864569
Black | 2833129
Gray | 2833130



HIGHLAND CAP

Red | 2864567
Navy | 2833126
Gray | 2833506

BEANIES



STAPLE BEANIE

Purple | 2864693
Radiant Green | 2833121
Gray | 2833122
Black | 2833116
Navy | 2833117

CORE BEANIE

Red | 2864695
Olive | 2864696
Blue | 2833114
Black | 2862530
Orange | 2862595

SWITCHBACK BEANIE

Olive | 2864694
Blue | 2833115
Black | 2862532
Gray | 2862533



LOOSE FIT BEANIE

Olive | 2864708
Fuchsia | 2864709
Black/White | 2864710



MARLED CUFF BEANIE

Pink | 2864707
Gray | 2864706



FAIR ISLE POM BEANIE

White | 2864701
Teal | 2864702



SPACE DYE POM BEANIE

Blue | 2864703
Pink | 2864704



FAIR ISLE TASSEL BEANIE

Black/White | 2864711



REMOVABLE POM BEANIE

Red | 2864705
Black | 2833119
Green | 2861513
Gray | 2861514

APPAREL

RACING COLLECTION

JERSEYS & GLOVES
& HEATED APPAREL

HELMETS & GOGGLES

MENS APPAREL

BALL CAPS & BEANIES

WOMENS APPAREL

HOME & COLLECTIBLES

WOMEN'S APPAREL



BLUE/GRAY
2864519



BLACK
2833041



RADIANT GREEN
2833040



BLACK
2861433



DEEP LAGOON
2864520

SOFTSHELL JACKET

VERSATILE LIGHTWEIGHT JACKET THAT'S PERFECT FOR EVERYDAY WEAR

S-3XL

- Casual jacket armed with rugged and warm features for everyday wear
- Superior DWR prevents precipitation from saturating the jacket's exterior
- Lined with 280g of soft fleece for warmth
- Removable hood and underarm venting, three external pockets and one internal chest pocket

FORCE PUFFER JACKET

PACKABLE JACKET OFFERS LIGHTWEIGHT PROTECTION & INCREDIBLE WARMTH

S-3XL

- 140g 3M™ Thinsulate®
- Two external hand pockets and one internal media pocket
- Rugged YKK® zippers
- Compactable into travel pocket



BLACK
2862563

BLUE
2862564

WORK JACKET

WARM AND RUGGED JACKET THAT'S TOUGH FOR WORK & STYLISH FOR PLAY

S-3XL

- 100% nylon shell is coated with Durable Water Repellency to help keep you dry
- Built-in action back for increased range of motion
- 80g 3M™ Thinsulate® for added warmth with brushed flannel trim
- One inner and four outer pockets for storage



BLUE
2864530

RADIANT GREEN
2833042

BLACK/GRAY
2862458

TITAN MID-LAYER

VERSATILE MID-LAYER CAN BE WORN ALONE OR AS AN EXTRA LAYER

S-3XL

- 319g Polartec® Thermal Pro® Rib Sweater provides great warmth
- Breathable material moves sweat to the outer surface
- Nylon overlay is comfortable and light



PLAID FLANNEL SHIRT

Blue | S-3XL | 2864673
Teal | S-3XL | 2864674



STAPLE HOODIE

Blue | S-3XL | 2864607
Deep Lagoon | S-3XL | 2864608
Gray | S-3XL | 2833096
Black | S-3XL | 2833095



JOURNEY HOODIE

Purple | S-3XL | 2864537
Radiant Green | S-3XL | 2833098
Black | S-3XL | 2862515



UPF POLARIS HOODIE TEE

Pink | S-3XL | 2833102
Teal | S-3XL | 2833103



ADVENTURE CREW

Misty Blue | S-2XL | 2864602
Black/Radiant Green | S-2XL | 2833100
Green | S-2XL | 2833101
Dusty Rose | S-2XL | 2862513



BACK

ADVENTURE LONG SLEEVE

White | S-3XL | 2864611
Gray | S-3XL | 2833107
Navy | S-3XL | 2833108



CORE TANK

Black | S-3XL | 2833161
Gray | S-3XL | 2833160



FLAG TEE

Gray | S-3XL | 2833163
White | S-3XL | 2833162



VENTURE TEE

Heather Gray | S-3XL | 2864625
Turquoise | S-3XL | 2864626

HOME & COLLECTIBLES



POLARIS KEY RACK

30.5 cm x 20 cm | 2864718



POLARIS LED SIGN

61 cm x 26.7 cm | 2862736



POLARIS RACING LED SIGN

61 cm x 22.9 cm | 2862737



ALUMINUM SIGN

55.9 cm | 2860867



WOOD SIGN

61 cm x 26.7 cm | 2860866



POLARIS STEEL SIGN

91.4 cm x 35.6 cm | 2860868

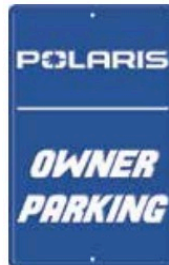

POLARIS PARKING SIGN

2869934



POLARIS FLAG

152 cm x 91.4 cm | 2869928



POLARIS RACING MUG

2864716



12 OZ CAMPER MUG*

2861612



23 OZ WATER BOTTLE*

2862685



15 OZ CAMPFIRE MUG*

2861613



POLARIS PVC COASTERS
2864715



POLARIS LOWBALL GLASSES WITH COASTERS (SET OF 2)
2864721



FLASK*
2860812



PREMIUM KOOZIE*
2860829



KICKBACK ROCKER*
■ ■ ■ Green | 2864816
Blue | 2862626



FREESTYLE ROCKER*
2862625



EASY CHAIR*
2862627



NEW PICO CHAIR*
2864817



QUICK-E-SEAT*
2862624



FOLDABLE TABLE
2861620



KEYCHAIN
2861614



LEATHER KEY CHAINS
Leather Loop | 2861615
Black Leather | 2861616



DECK OF CARDS
2860816



POLARIS NOTEBOOK
2860831



HITCH COVER
2861623



LICENSE PLATE HOLDER
2862687

*Not available in Europe

FIND YOUR NEXT ADVENTURE



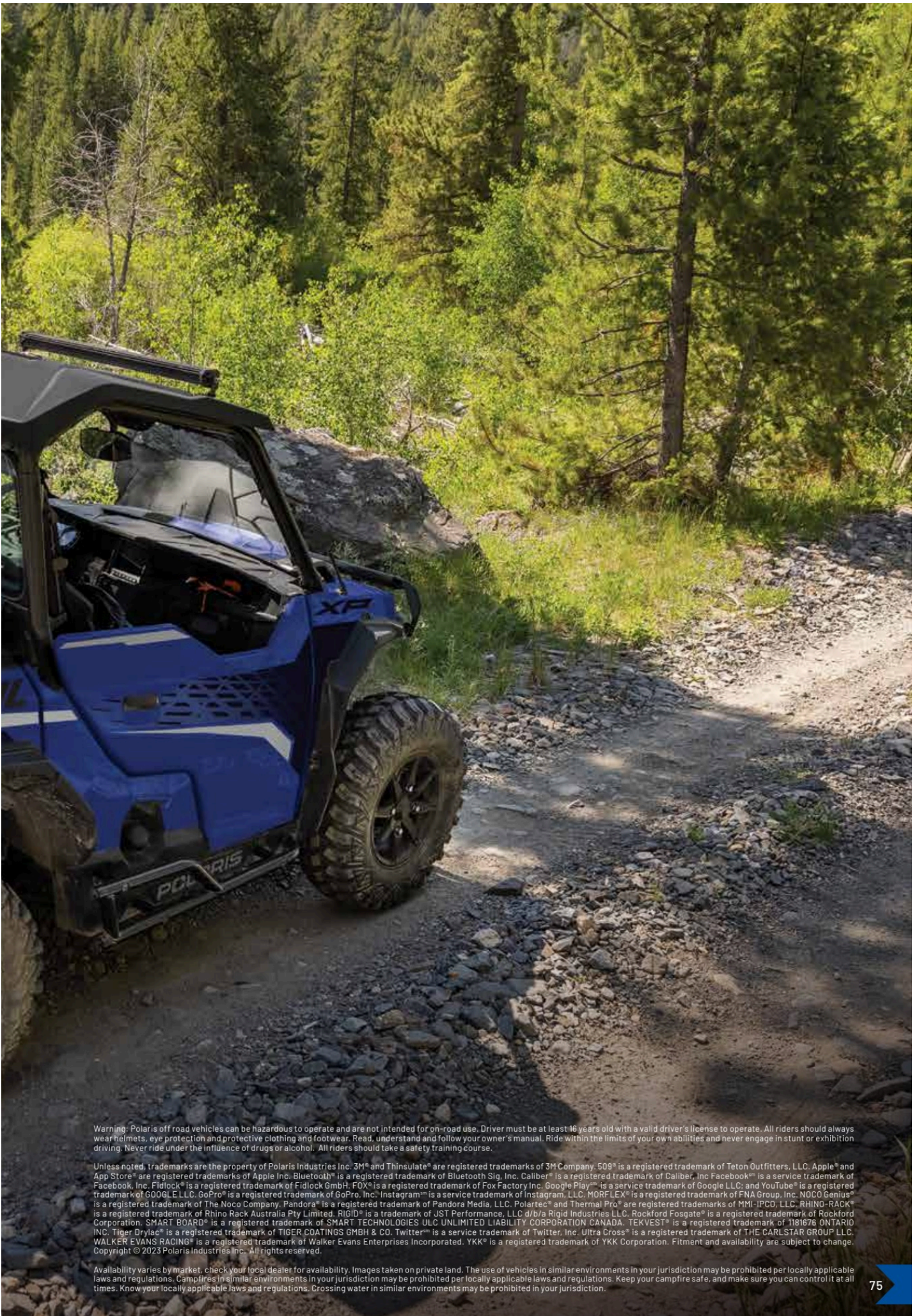

Warning: Polaris off road vehicles can be hazardous to operate and are not intended for on-road use. Driver must be at least 16 years old with a valid driver's license to operate. All riders should always wear helmets, eye protection and protective clothing and footwear. Read, understand and follow your owner's manual. Ride within the limits of your own abilities and never engage in stunt or exhibition driving. Never ride under the influence of drugs or alcohol. All riders should take a safety training course.

Unless noted, trademarks are the property of Polaris Industries Inc. 3M® and Thinsulate® are registered trademarks of 3M Company. 509® is a registered trademark of Teton Outfitters, LLC. Apple® and App Store® are registered trademarks of Apple Inc. Bluetooth® is a registered trademark of Bluetooth SIG, Inc. Caliber® is a registered trademark of Caliber, Inc. Facebook™ is a service trademark of Facebook, Inc. Fidlock® is a registered trademark of Fidlock GmbH. FOX® is a registered trademark of Fox Factory Inc. Google Play™ is a service trademark of Google LLC; and YouTube® is a registered trademark of GOOGLE LLC. GoPro® is a registered trademark of GoPro, Inc. Instagram™ is a service trademark of Instagram, LLC. MORFLEX® is a registered trademark of FNA Group, Inc. NOCO Genius® is a registered trademark of The Noco Company. Pandora® is a registered trademark of Pandora Media, LLC. Polartec® and Thermal Pro® are registered trademarks of MMI-IPCO, LLC. RHINO-RACK® is a registered trademark of Rhino Rack Australia Pty Limited. RIGID® is a trademark of JST Performance, LLC d/b/a Rigid Industries LLC. Rockford Fosgate® is a registered trademark of Rockford Corporation. SMART BOARD® is a registered trademark of SMART TECHNOLOGIES ULC UNLIMITED LIABILITY CORPORATION CANADA. TEKVEST® is a registered trademark of 1181676 ONTARIO INC. Tiger Drylac® is a registered trademark of TIGER COATINGS GMBH & CO. Twitter™ is a service trademark of Twitter, Inc. Ultra Cross® is a registered trademark of THE CARLSTAR GROUP LLC. WALKER EVANS RACING® is a registered trademark of Walker Evans Enterprises Incorporated. YKK® is a registered trademark of YKK Corporation. Fitment and availability are subject to change. Copyright © 2023 Polaris Industries Inc. All rights reserved.

Availability varies by market, check your local dealer for availability. Images taken on private land. The use of vehicles in similar environments in your jurisdiction may be prohibited per locally applicable laws and regulations. Campfires in similar environments in your jurisdiction may be prohibited per locally applicable laws and regulations. Keep your campfire safe, and make sure you can control it at all times. Know your locally applicable laws and regulations. Crossing water in similar environments may be prohibited in your jurisdiction.

UNLOCK MORE
ADVENTURE



POLARIS
Think Outside

MY24 GENERAL APP ACC EMEA