

POLARIS RZR



2024

**ACCESSORIES,
MAINTENANCE & APPAREL**

EMEA VERSION



ACCELERATE BEYOND THE EVERYDAY

#RZRLife

LIVE THE LIFESTYLE.
JOIN THE COMMUNITY.



06 RZR PRO R, TURBO R & PRO XP

- 24 AUDIO
- 26 WINDSHIELDS & REAR PANELS
- 28 ROOFS, DOORS & HEATER
- 30 VEHICLE PROTECTION
- 32 LIGHTING
- 34 STORAGE
- 36 MISC, MIRRORS & WINCHES

38 RZR XP

- 44 AUDIO
- 46 WINDSHIELDS & REAR PANELS
- 48 ROOFS, DOORS & HEATER
- 50 VEHICLE PROTECTION
- 52 LIGHTING
- 54 STORAGE
- 56 MIRRORS & WINCHES
- 58 2014-2023 XP 1000, XP TURBO & TURBO S

62 RZR TRAIL S

- 68 WINDSHIELDS & REAR PANELS
- 70 ROOFS, DOORS & AUDIO
- 72 VEHICLE PROTECTION & STORAGE
- 74 WINCHES, HEATER & PLOWS
- 76 LIGHTING, ELECTRICAL & TRACKS
- 78 ACCESSORIZE

80 COMMON ACCESSORIES

- 80 LIGHTING
- 86 CONNECTED TECHNOLOGY
- 88 PRO ARMOR WHEELS & TIRES
- 104 POLARIS NORTHSTAR COOLERS
- 106 COCKPIT ACCESSORIES & MIRRORS
- 108 WINCHES
- 110 ADDITIONAL ACCESSORIES

110 YOUTH

112 MAINTENANCE & GARAGE

- 114 MAINTENANCE
- 116 OIL & LUBRICANTS
- 118 MAINTENANCE FLUIDS
- 120 HD PARTS
- 122 SERVICE PARTS
- 124 CLEANERS & TRAILERING

126 APPAREL

- 128 RACING COLLECTION
- 130 JERSEYS, GLOVES & POLARIS RACING
- 132 HELMETS & GOGGLES
- 134 RZR APPAREL & MERCH
- 136 MEN'S APPAREL
- 140 BALL CAPS & BEANIES
- 142 WOMEN'S APPAREL
- 144 HOME & COLLECTIBLES

IMPORTANT: Adding accessories may impact the vehicle's conformity to its homologation or type approval. Polaris recommends consulting with local authorities and/or your local dealer to understand the requirements and restrictions related to the installation of accessories on your vehicle.



DESIGNED by the people who designed your vehicle.

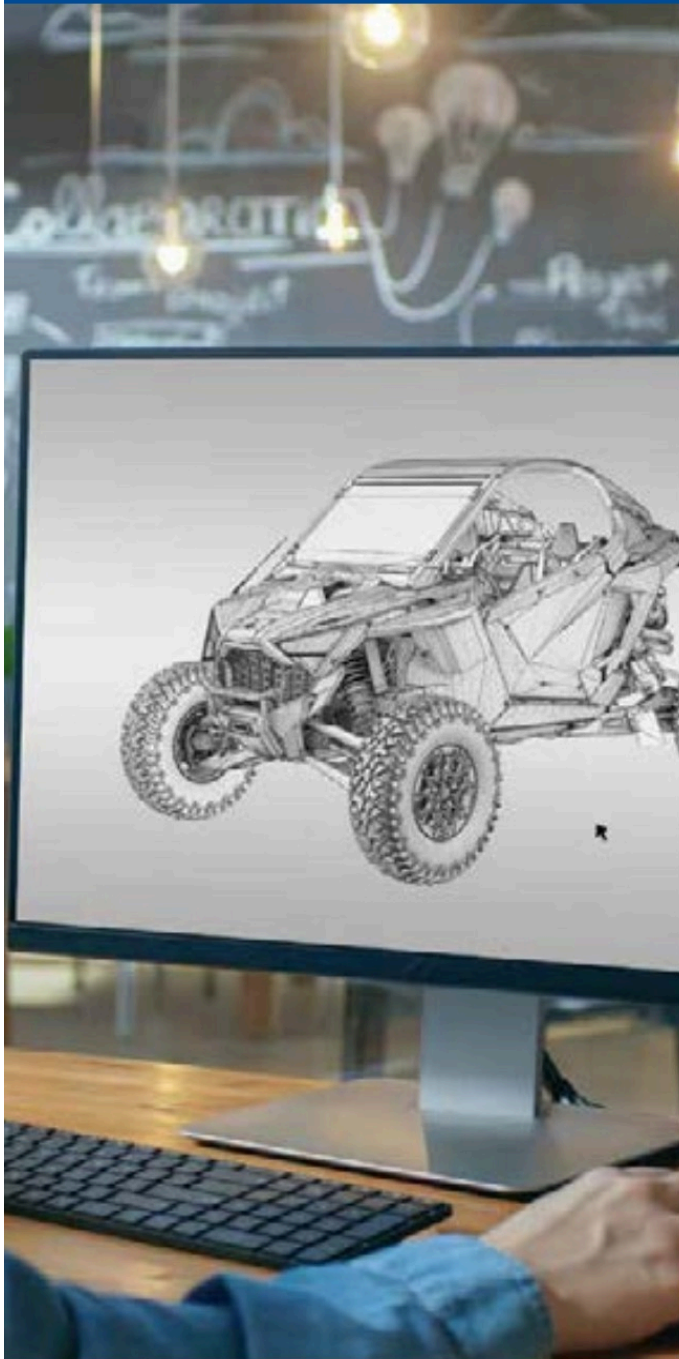

TESTED extensively in the field so you ride with 100% confidence.



WE HOLD OUR PARTNERS TO THE SAME STANDARDS



PREMIUM AFTERMARKET OPTIONS DESIGNED WITH POLARIS TO MAXIMIZE PERFORMANCE
P. 85, 88



A GLOBAL LEADER IN AUDIO INNOVATION, DESIGN AND ENGINEERING
P. 24, 44, 71

KEEP YOUR
STANDARDS HIGH.
WE DO.

TRUSTED 65+ years in the business.
The #1 name in off-road.



FIGID

PRODUCTS SO GOOD THEY REPLACE
OR REPAIR THEM FOR LIFE
P. 32, 52, 84



MILITARY-GRADE AIR FILTRATION THAT KEEPS YOUR
AIR FILTER CLEAN AND ENGINE PROTECTED
P. 36

RZR PRO R

POLARIS
RZR PRO R



POWER | STRENGTH | CONTROL



> OPTIMAL PERFORMANCE

Easy customization solutions designed to fit perfectly and mount effortlessly.

ROCKFORD FOSGATE AUDIO P. 24
PROTECTION P. 30
RIGID LIGHTING P. 32
POLARIS PULSE P. 33



> TOTAL RELIABILITY

Personalized comfort with end-to-end protection from the elements.

WINDSHIELDS P. 27
REAR PANELS P. 27
DOORS P. 29



> UNRIVALED FLEXIBILITY

Accessory options to give you even more reason to get out and stay riding.

STORAGE P. 34
COOLERS P. 35
PRO ARMOR WHEELS & TIRES P. 88



> DUNE COLLECTION

Carve through the soft sands and tackle each hill with confidence.

- 2884746 **LR RIDE** Half Windshield- Hard Coat Poly, Low: P. 27
- 2884325-458 Aluminum Roof, 4-Seat*: P. 28
- 2884660-458 Aluminum Doors, 4-Seat: P. 29
- 2884354-458 Front Pre Runner Bumper: P. 31
- 2883763 Premium Convex Rearview Mirror: P. 36

- 2883857 Stage 3 Audio Upgrade by Rockford Fosgate®: P. 24
- 2883945 Rear Speaker Pods by Rockford Fosgate®: P. 24
- 2884648 RIGID® SR-Series 81.3 cm Combo LED Light Bar: P. 32
- 2884601 81.3 cm Light Bar Mount: P. 32
- 2889130 Polaris PULSE HD Light Bar Harness: P. 32



2884359 RIGID® Chase Light: P. 33
 2884896 Chase Light Mount Kit: P. 33
 2889034 Chase Light Harness Kit: P. 33
 2884235 **LR LACK RIDE** 57 L Forward Cargo Box: P. 34



2889740 **LR LACK RIDE** 22 L Rear Cooler: P. 35
 2889784 7 L Door Storage Bag: P. 35
 2885020 Pro Armor Wheel & Tire Set:
 5207/5303 & Sand 16XT, 32": P. 103

Shown on Pro R 4-Seat.
 *Aluminum roof comes stock on Premium/Ultimate models.



» DESERT COLLECTION

Dominate rocky environments and charge through endless miles of hard-pack terrain.

- | | | | |
|-------------|---|-------------|--|
| 2884747 |  Full Vented Windshield
- Hard Coat Poly, 4-Seat: P. 27 | 2884359 | RIGID® Chase Light: P. 33 |
| 2884325-458 | Aluminum Roof, 4-Seat*: P. 28 | 2884896 | Chase Light Mount Kit: P. 33 |
| 2884355-293 | Front Pre Runner Winch Bumper: P. 31 | 2889034 | Chase Light Harness Kit: P. 33 |
| 2884358-293 | Rear Pre Runner Bumper: P. 31 | 2884235 |  57 L Forward Cargo Box: P. 34 |
| 2889209-293 | HD Extreme Kick-Out Rock Sliders, 4-Seat: P. 31 | 2889740 |  22 L Rear Cooler: P. 35 |
| 2883763 | Premium Convex Rearview Mirror: P. 36 | 2884326-458 | Pivoting Spare Tire Carrier: P. 35 |
| 2883762 | Adjustable Folding Side Mirrors: P. 36 | 2884341 | Polaris Pro HD 2,721 kg Winch: P. 37 |
| 2884648 | RIGID® SR-Series 81.3 cm Combo LED Light Bar: P. 32 | 2885012 | Pro Armor Wheel & Tire Set:
5302 & Pro Runner, 33": P. 103 |
| 2884601 | 81.3 cm Light Bar Mount: P. 32 | 5417533 | Pro Armor Spare Tire: Pro Runner, 33": P. 93 |
| 2889130 | Polaris PULSE HD Light Bar Harness: P. 32 | 1524038 | Pro Armor Spare Wheel: 5302, 15": P. 100 |

➤ RUGGED TRAIL COLLECTION

Take on unpredictable landscapes and climb to new heights for epic views.

- 2884350 Full Vented Windshield - Glass, 2-Seat: P. 27
- 2884352  Poly Rear Panel, 2-Seat: P. 27
- 2884237-458 Aluminum Roof, 2-Seat*: P. 28
- 2884658 Front Door Inner Closeoff Panels, 2-Seat: P. 29
- 2884353-458 Front High Coverage Bumper: P. 30
- 2884356-458 Rear High Coverage Bumper: P. 30
- 2884685 Full Coverage Fender Flares: P. 30
- 2883763 Premium Convex Rearview Mirror: P. 36
- 2883762 Adjustable Folding Side Mirrors: P. 36
- 2884256 PMX-P2 Head Unit by Rockford Fosgate®: P. 24
- 2883943 Stage 2 Audio Kit by Rockford Fosgate®: P. 24

- 2883857 Stage 3 Audio Upgrade by Rockford Fosgate®: P. 24
- 2889790 Pro Armor 12.2 cm Dual-Row LED Light Bar: P. 85
- 2889130 Polaris PULSE HD Light Bar Harness: P. 85
- 2412616 Adapter Harness: P. 85
- 2884235  57 L Forward Cargo Box: P. 34
- 2889785 9 L Shoulder Storage Bag: P. 35
- 2884341 Polaris Pro HD 2,721 kg Winch: P. 37
- 2885014 Pro Armor Wheel & Tire Set: 5206 & Crawler XR, 33": P. 103

Shown on Pro R 2-Seat.
*Aluminum roof comes stock on Premium/Ultimate models.

RZR TURBO R

POLARIS
RZR TURBO R



POWER | STRENGTH | CONTROL



> SUPERIOR INNOVATION

Seamlessly integrated technology offerings that take your ride to the next level.

ROCKFORD FOSGATE® AUDIO P. 24
RIGID® LIGHTING P. 32
POLARIS PULSE P. 33
INTEGRATED WINCH P. 37



> ENDLESS CUSTOMIZATION

A complete accessory lineup developed to fit the needs of every riding style.

STORAGE P. 34
COOLERS P. 35
PRO ARMOR WHEELS & TIRES P. 88



> UNRELENTING TOUGHNESS

Expertly engineered products that are sure to stand up to the elements.

WINDSHIELDS P. 27
ROOFS P. 28
PROTECTION P. 30



› DESERT COLLECTION

Dominate rocky environments and charge through endless miles of hard-pack terrain.

2889019	Full Vented Windshield - Glass: P. 27	2883762	Adjustable Folding Side Mirrors: P. 36
2890145	Glass Windshield Wiper Kit: P. 27	2889463	Stage 5 Audio Upgrade by Rockford Fosgate®: P. 24
2883990-458	Aluminum Roof, 4-Seat*: P. 28	2884648	RIGID® SR-Series 81.3 cm Combo LED Light Bar: P. 32
2884355-458	Front Pre Runner Winch Bumper: P. 31	2884650	81.3 cm Light Bar Mount: P. 32
2884585-458	Rear Pre Runner Bumper: P. 31	2889130	Polaris PULSE HD Light Bar Harness: P. 32
2889209-458	HD Extreme Kick-Out Rock Sliders, 4-Seat: P. 31	2884359	RIGID® Chase Light: P. 33
2883763	Premium Convex Rearview Mirror: P. 36	2884896	Chase Light Mount Kit: P. 33



- 2889034 Chase Light Harness Kit: P. 33
- 2883751  70 L Forward Cargo Box: P. 34
- 2889740  22 L Rear Cooler: P. 35
- 2884666  72 L Multi-Passenger Rear Seat Cargo Box: P. 35
- 2889784 7 L Door Storage Bag: P. 35
- 2889404-458 Pivoting Spare Tire Carrier: P. 35

- 2884341 Polaris Pro HD 2,721 kg Winch: P. 37
- 2885008 Pro Armor Wheel & Tire Set:
5302 Beadlock & Crawler XR, 33": P. 103
- 5417174 Pro Armor Spare Tire: Crawler XR, 33": P. 94
- 1524038 Pro Armor Spare Wheel:
5302 Beadlock, 15": P. 100



Shown on Turbo R 4-Seat.
*Aluminum roof comes stock on Premium/Ultimate models.



> DUNE COLLECTION

Carve through the soft sands and tackle each hill with confidence.

- 2884746  Half Windshield - Hard Coat Poly, Low: P. 27
- 2883991-458 Light Pocket Aluminum Roof, 4-Seat: P. 28
- 2884660-458 Aluminum Doors, 4-Seat: P. 29
- 2884354-293 Front Pre Runner Bumper: P. 31
- 2883763 Premium Convex Rearview Mirror: P. 36
- 2884256 PMX-P2 Head Unit by Rockford Fosgate®: P. 24
- 2883943 Stage 2 Audio Kit by Rockford Fosgate®: P. 24
- 2884655 Stage 4 Audio Upgrade by Rockford Fosgate®: P. 24
- 2883945 Rear Speaker Pods by Rockford Fosgate®: P. 24
- 2884074 RIGID® SR-Series 71.1 cm Combo LED Light Bar: P. 32
- 2889130 Polaris PULSE HD Light Bar Harness: P. 32

- 2884359 RIGID® Chase Light: P. 33
- 2884896 Chase Light Mount Kit: P. 33
- 2889034 Chase Light Harness Kit: P. 33
- 2884346 Accent Light: P. 33
- 2883752  40 L Rear Cargo Box: P. 34
- 2883424 Polaris NorthStar 28 L Cooler: P. 35
- 2884070  NorthStar 28 L Cooler Bracket: P. 35
- 2889784 7 L Door Storage Bag: P. 35
- 2885020 Pro Armor Wheel & Tire Set:
5207/5303 & Sand 16XT, 32": P. 103

➤ RUGGED TRAIL COLLECTION

Take on unpredictable landscapes and climb to new heights for epic views.

- | | | | |
|-------------|--|-------------|--|
| 2884305 |  Full Vented Windshield - Hard Coat Poly: P. 27 | 2412616 | Adapter Harness: P. 85 |
| 2883757 |  Poly Rear Panel, 2-Seat: P. 27 | 2883751 |  70 L Forward Cargo Box: P. 34 |
| 2883743-458 | Aluminum Roof, 2-Seat*: P. 28 | 2883752 |  40 L Rear Cargo Box: P. 34 |
| 2884353-458 | Front High Coverage Bumper: P. 30 | 2889785 | 9.5 L Shoulder Storage Bag: P. 35 |
| 2884189-458 | Rear High Coverage Bumper: P. 30 | 2889784 | 7 L Door Storage Bag: P. 35 |
| 2889208-458 | HD Extreme Kick-Out Rock Sliders, 2-Seat: P. 31 | 2889404-458 | Pivoting Spare Tire Carrier: P. 35 |
| 2883763 | Premium Convex Rearview Mirror: P. 36 | 2884340 | Polaris Pro HD 2,041 kg Winch: P. 37 |
| 2883762 | Adjustable Folding Side Mirrors: P. 36 | 2885018 | Pro Armor Wheel & Tire Set:
5206 & Pro Runner, 33": P. 103 |
| 2884655 | Stage 4 Audio Upgrade by Rockford Fosgate®: P. 24 | 5417533 | Pro Armor Spare Tire: Pro Runner, 33": P. 93 |
| 2889791 | Pro Armor 83.8 cm Combo LED Light Bar: P. 85 | 1524041 | Pro Armor Spare Wheel: 5206, 15": P. 100 |
| 2889130 | Polaris PULSE HD Light Bar Harness: P. 85 | | |

Shown on Turbo R 2-Seat.
*Aluminum roof comes stock on Premium/Ultimate models.

RZR PRO XP

POLARIS
RZR PRO XP



**MOST VERSATILE
& CAPABLE RZR**

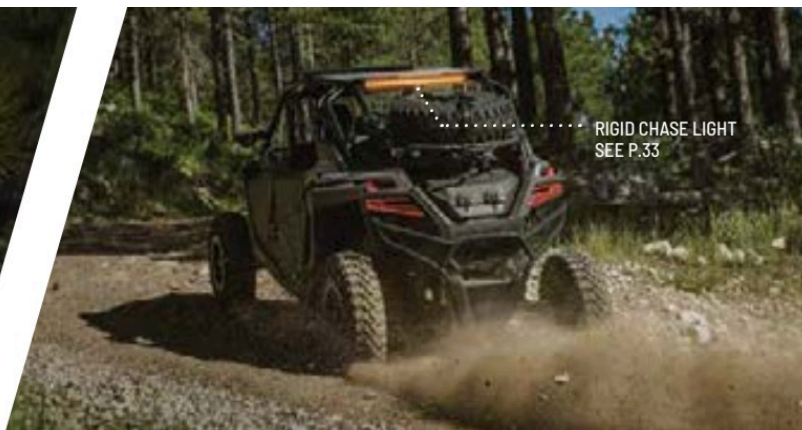

> UNMATCHED ENGINEERING

Next-level innovation makes this RZR unlike anything you've ever owned.

ROCKFORD FOSGATE AUDIO P. 24
RIDE COMMAND P. 24
RIGID LIGHTING P. 32
POLARIS PULSE P. 33
INTEGRATED WINCH P. 37



> VISIONARY DESIGN

Relentless attention to detail delivers extraordinary style and function for the ultimate ride.

WINDSHIELDS P. 27
ROOFS P. 28
DOORS P. 29
MIRRORS P. 36



> ELEVATED FUNCTIONALITY



An unrivaled selection of accessories gives you even more reason to get out - and stay out - riding.

PROTECTION P. 30
STORAGE P. 34
PRO ARMOR WHEELS & TIRES P. 88

> DESERT COLLECTION

Dominate the rocky landscape and charge through endless miles of desert.



2889019 Full Vented Windshield - Glass: P. 27
2890145 Glass Windshield Wiper Kit: P. 27
2883990-458 Aluminum Roof, 4-Seat: P. 28
2883749-458 Front High Coverage Bumper: P. 30
2884189-458 Rear High Coverage Bumper: P. 30
2884359 RIGID® Chase Light: P. 33
2884896 Chase Light Mount Kit: P. 33

2889034 Chase Light Harness: P. 33
2883751  70 L Forward Cargo Box: P. 34
2889740  22 L Rear Cooler: P. 35
2884666  72 L Multi-Passenger
Rear Seat Cargo Box: P. 35
2889404-458 Pivoting Spare Tire Carrier: P. 35

> TRAIL COLLECTION

Navigate the trails through forests, hills and plains.

- 2883756  Full Vented Windshield - Hard Coat Poly: P. 27
- 2883928 Poly Sport Roof, 2-Seat: P. 28
- 2883749-458 Front High Coverage Bumper: P. 30
- 2884189-458 Rear High Coverage Bumper: P. 30
- 2889208-458 HD Extreme Kick-Out Rock Sliders, 2-Seat: P. 31

- 2883751  70 L Forward Cargo Box: P. 34
- 2883752  40 L Rear Cargo Box: P. 34
- 2889784 7.25 L Door Storage Bag: P. 35
- 2889404-458 Pivoting Spare Tire Carrier: P. 35
- 2883758 Polaris Pro HD 2,041 kg Winch: P. 37



> MOUNTAIN COLLECTION

Climb pristine mountain trails for an epic view.

2883756  Full Vented Windshield - Hard Coat Poly: P. 27

2883928 Poly Sport Roof, 2-Seat: P. 28

2883749-458 Front High Coverage Bumper: P. 30

2884189-458 Rear High Coverage Bumper: P. 30

2889208-458 HD Extreme Kick-Out Rock Sliders, 2-Seat: P. 31

2883752  40 L Rear Cargo Box: P. 34

2889784 7.25 L Door Storage Bag: P. 35

2889404-458 Pivoting Spare Tire Carrier: P. 35

2883758 Polaris Pro HD 2,041 kg Winch: P. 37

> ALL-SEASON COLLECTION

Take advantage of any season with year-round riding.

- 2889536 Tip Out Windshield - Hard Coat Poly: P. 27
- 2883757  Poly Rear Panel, 2-Seat: P. 27
- 2883743-458 Aluminum Roof, 2-Seat: P. 28
- 2884664 Upper Doors, 2-Seat: P. 29
- 2884658 Front Door Inner Closeoff Panels: P. 29

- 2883749-458 Front High Coverage Bumper: P. 30
- 2884189-458 Rear High Coverage Bumper: P. 30
- 2884685 Full Coverage Fender Flares: P. 30
- 2884386 Heater Kit: P. 29

> AUDIO



Rockford Fosgate partnered with Polaris to create the next evolution of factory-installed off-road audio. Purpose-built to stand up to any outdoor environment and designed to perform no matter the ride. Specifically tuned and rider-centric to create an audio experience that is second to none.



PLUG & PLAY



ELEMENT READY



NO LOSS OF CARGO SPACE



BLUETOOTH

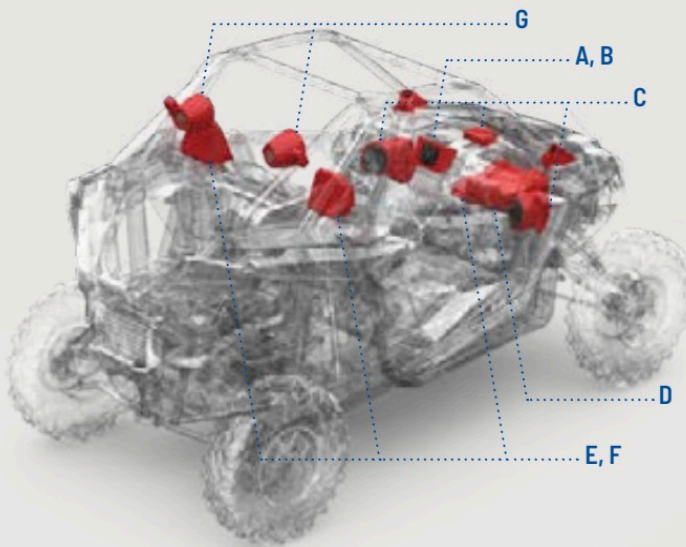

SOURCE UNITS

- Designed specifically for the Pro platform
- Tuned to combat wind and motor noise, delivering an incredible sound no matter the speed
- Element ready design guards against dust and moisture intrusion

AMPLIFIERS

- Ultra Compact CLEAN technology
- Highly efficient design capable of being pushed hard without overheating

SPEAKERS

- Off-road Optimized Element Ready speakers thrive in any outdoor environment
- Specifically tuned enclosures create rich cockpit sound
- Rugged, yet lightweight, materials that don't sacrifice speed for sound

SUBWOOFERS

- High-power, high-excursion subwoofer that acoustically couples with the cockpit for perfect bass response
- Torture tested to ensure long life and performance



A. 7" DISPLAY POWERED BY RIDE COMMAND*

» 2884072

PRO R/4 '22-24, TURBO R/4 '22-24, PRO XP/4 '20-24

STANDARD ON PREMIUM/ULTIMATE MODELS

Requires Mount Kit 2884584

SEE P. 86 FOR FULL RIDE COMMAND DETAILS



B. PMX-P2 HEAD UNIT

- 6.86 cm full color display
- AM/FM/WB tuner* & Pandora control
- Bluetooth connectivity
- Includes mount kit

» 2884256

PRO R/4 '22-24, TURBO R/4 '22-24, PRO XP/4 '20-24

NOT COMPATIBLE WITH PREMIUM/ULTIMATE MODELS



C. STAGE 2 ^{TOP SELLER} FULL RANGE AMPLIFIER AND FRONT UNDER-DASH SPEAKERS

- 400 watt full range amplifier
- 50 watt 16.51 cm component speakers including tweeters with enclosures

» 2883943

PRO R/4 '22-24, TURBO R/4 '22-24, PRO XP/4 '20-24

STANDARD ON PREMIUM/ULTIMATE MODELS

Harness (2415467) required with PMX-P2 Head Unit on Sport models



D. STAGE 3 25.4 cm POWERED SUBWOOFER UPGRADE

- 400 watt 25.4 cm subwoofer with enclosure and grille
- 400 watt integrated subwoofer amplifier

» 2883857

PRO R/4 '22-24, TURBO R/4 '22-24, PRO XP/4 '20-24



E. STAGE 4 25.4 cm POWERED SUBWOOFER WITH REAR COAXIAL SPEAKER UPGRADE

- 400 watt 25.4 cm subwoofer with enclosure and grille
- 400 watt integrated subwoofer amplifier
- 50 watt 16.51 cm coaxial speakers with enclosures and grilles

» 2884655

PRO R/4 '22-24, TURBO R/4 '22-24, PRO XP/4 '20-24



F. STAGE 5 30 cm POWERED SUBWOOFER WITH FULL SYSTEM SPEAKER UPGRADE

- 400 watt 30 cm subwoofer with enclosure and grille
- 400 watt integrated subwoofer amplifier
- 100 watt 16.51 cm coaxial speakers with enclosures and stainless steel grilles
- 100 watt 16.51 cm front component replacement speakers
- High output tweeters with stainless steel grilles
- 2x more power and sound delivery over the stock system

» 2889463

PRO R/4 '22-24, TURBO R/4 '22-24, PRO XP/4 '20-24

COMPATIBLE WITH PREMIUM/ULTIMATE MODELS ONLY. Premium models require 2884904, sold separately.

Not compatible with Rear Pods (2883945).

Subwoofer addition eliminates glove box storage



G. REAR PODS USE WITH STAGE 2, STAGE 3 OR STAGE 4

- 50 watt 16.51 cm coaxial speakers with can-enclosures, mounting hardware and grilles

» 2883945

PRO R/4 '22-24, TURBO R/4 '22-24, PRO XP/4 '20-24

Not compatible with Rockford Fosgate® Ultimate LE models or Stage 5 Audio Upgrade (2889463)

BUILD YOUR SOUND

(CHOOSE THE PATH THAT MATCHES YOUR RZR)

PRO R, TURBO R & PRO XP

AUDIO

WINDSHIELDS & REAR PANELS

ROOF, DOORS & HEATER

VEHICLE PROTECTION

LIGHTING

STORAGE

MISC. MIRRORS & WINDSHIELDS

FACTORY-INSTALLED

SKIP TO STEP 3



PRO R, TURBO R & PRO XP PREMIUM

2-SEAT

PMX-P2
+
STAGE 1

4-SEAT

PMX-P2
+
STAGE 1 &
REAR SPEAKERS



PRO R, TURBO R & PRO XP ULTIMATE

2-SEAT

RIDE COMMAND
+
STAGE 2

4-SEAT

RIDE COMMAND
+
STAGE 2 &
REAR SPEAKERS

NO FACTORY AUDIO

STEP 1

SELECT HEAD UNIT

PMX-P2 HEAD UNIT

2884256

PRO R/4 '22-24, TURBO R/4 '22-24,
PRO XP/4 '20-24

NOT COMPATIBLE WITH
ULTIMATE MODELS
Mount kit included

OR

7" DISPLAY WITH RIDE COMMAND*

2884072

PRO R/4 '22-24, TURBO R/4 '22-24,
PRO XP/4 '20-24

MOUNT KIT REQUIRED
2884584

PRO R/4 '22-24, TURBO R/4 '22-24,
PRO XP/4 '20-24

SEE P. 86 FOR FULL RIDE COMMAND DETAILS

STEP 2

ADD AUDIO KIT

STAGE 2

FULL RANGE AMPLIFIER AND FRONT UNDER-DASH SPEAKERS
2883943

PRO R/4 '22-24, TURBO R/4 '22-24, PRO XP/4 '20-24
STANDARD ON ULTIMATE MODELS

Harness (2415467) required with PMX-P2 Head Unit on Sport models

STEP 3

UPGRADE AUDIO

PRO R, TURBO R & PRO XP PREMIUM

AMP UPGRADE KIT

2884908

PRO R/4 '22-24, TURBO R/4 '22-24,
PRO XP/4 '20-24

PREMIUM MODELS ONLY
REQUIRED FOR ANY PREMIUM
UPGRADE TO STAGE 3-5

+

STAGE 3

25.4 CM POWERED
SUBWOOFER UPGRADE
2883857

PRO R/4 '22-24, TURBO R/4 '22-24,
PRO XP/4 '20-24

NOT COMPATIBLE WITH STAGE 4

OR

STAGE 4

25.4 CM POWERED SUBWOOFER WITH
REAR COAXIAL SPEAKER UPGRADE
2884655

PRO R/4 '22-24, TURBO R/4 '22-24,
PRO XP/4 '20-24

NOT COMPATIBLE WITH STAGE 3
ALL 4-SEAT MODELS WITH FACTORY AUDIO
INCLUDE REAR SPEAKERS

OR

STAGE 5

30 CM POWERED SUBWOOFER WITH
FULL SYSTEM SPEAKER UPGRADE
2889463

PRO R/4 '22-24, TURBO R/4 '22-24,
PRO XP/4 '20-24

PREMIUM/ULTIMATE MODELS ONLY
NOT COMPATIBLE WITH REAR PODS
(2883945), STAGE 3 OR STAGE 4

+ / OR

REAR PODS

2883945

PRO R/4 '22-24, TURBO R/4 '22-24, PRO XP/4 '20-24

Not compatible with Rockford Fosgate® Ultimate LE Models, Stage 5 Audio Upgrade (2889463)

ADD TO STAGES 2-4

*Due to ongoing supply chain issues, there may be delayed or limited availability of this product as an accessory add-on.



NEW AUDIO ROOF

20 CM SPEAKERS, 25.4 CM SUBWOOFER,
83.8 CM PRO ARMOR LIGHT BAR

- 800 watt
- 25.4 cm subwoofer
- 83.8 cm Pro Armor Single-Row Light Bar
- RGB accent lights
- LED dome light (2-Seat: 1, 4-Seat: 2)



PMX-P2 (Head unit included)

» 2-SEAT • 2889710

TURBO R '22-24, PRO XP '20-24

» 4-SEAT • 2889708

TURBO R 4 '22-24, PRO XP 4 '20-24

Not compatible with Rear Pods (2883945)
or Stages 2-5.

Secondary Battery Kit required
(2884347/2884391), sold separately.

VEHICLE-INTEGRATED AUDIO

» 2-SEAT • 2889711

TURBO R '22-24, PRO XP '20-24

» 4-SEAT • 2889709

TURBO R 4 '22-24, PRO XP 4 '20-24

Not recommended with Stage 5.
Secondary Battery Kit required
(2884347/2884391), sold separately.

RZR PRO R, TURBO R & PRO XP



> BUILD YOUR CAB

ADD COMFORT AND STYLE WITH END-TO-END PROTECTION

ADD A WINDSHIELD
Protect all riders with optical clarity.

ADD A ROOF
Shield from harsh elements while adding style.

ADD A REAR PANEL
Maintain rear visibility while reducing rear air swirl.



ADD DOORS
Keep the cab free of debris and water.

TURBO R PRO XP

RECOMMENDED 2-SEAT CAB

- 2889019 • Full Vented Windshield - Glass
- 2890145 • Glass Windshield Wiper Kit
- 2883757 • Poly Rear Panel
- 2883928 • Poly Sport Roof
- 2884664 • Upper Doors
- 2884658 • Front Door Inner Closeoff Panels

Available on 2-Seat and 4-Seat vehicles.

TURBO R PRO XP

RECOMMENDED 4-SEAT CAB

- 2884305 • Full Vented Windshield - Hard Coat Poly
- 2884147 • Poly Rear Panel
- 2883990-458 • Aluminum Roof
- 2884660-458 • Aluminum Doors
- 2884665 • Upper Doors

Available on 2-Seat and 4-Seat vehicles.

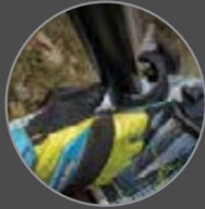

REVOLUTIONARY INSTALLATION

Lock & Ride clamps make for easy on-off and eliminate the risk of cracking.



POLARIS ENGINEERED ADVANTAGES

GASKETED SEAL

Keeps drafts and moisture out. Reduces ride chatter on full glass windshields.

WINDSHIELDS

GLASS



FULL VENTED WINDSHIELD - GLASS TOP SELLER

- Double-layer, laminated and tempered glass windshield with steel, powder-coated frame and adjustable center vent

» **TURBO R** **PRO XP** 2889019

TURBO R/4 '22-24, PRO XP/4 '20-24

Not compatible with Light Pocket Aluminum Roof (2883961, 2883991)

» **PRO R** 2-SEAT • 2884350

PRO R '22-24

» **PRO R** 4-SEAT • 2884823

PRO R 4 '22-24



GLASS WINDSHIELD WIPER KIT

- Simple to control with a multi-speed, dash-mounted switch
- Includes a washer fluid reservoir

» 2890145

TURBO R/4 '22-24, PRO XP/4 '20-24

Compatible with glass windshield only

HARD COAT POLY



FULL VENTED WINDSHIELD - HARD COAT POLY

- Impact-resistant, long-lasting .64 cm durable hard coated polycarbonate
- Full protection with airflow vents that quickly open for cockpit ventilation

» **TURBO R** **PRO XP** 2884305

TURBO R/4 '22-24, PRO XP/4 '20-24

Compatible with Aluminum Roof only (2883961, 2883743, 2883991, 2883990)

» **TURBO R** **PRO XP** 2883756

TURBO R/4 '22-24, PRO XP/4 '20-24

Compatible with Poly Sport Roof only (2883928, 2883946)

» **PRO R** 2-SEAT • 2884968

PRO R '22-24

» **PRO R** 4-SEAT • 2884747

PRO R 4 '22-24



TIP OUT WINDSHIELD - HARD COAT POLY

- Hard coated polycarbonate panel windshield with closed, vented and fully open positions
- Dual-handled latches with gas support struts

» **TURBO R** **PRO XP** 2889536

TURBO R/4 '22-24, PRO XP/4 '20-24

Not compatible with Light Pocket Aluminum Roof (2883961, 2883991)



HALF WINDSHIELD - HARD COAT POLY, MID TOP SELLER

- Impact-resistant, long-lasting .64 cm durable hard coated polycarbonate
- Provides both protection and airflow into the cab
- 30.48 cm tall

» 2884966

PRO R/4 '22-24, TURBO R/4 '22-24, PRO XP/4 '20-24



HALF WINDSHIELD - HARD COAT POLY, LOW TOP SELLER

- Provides added protection from the elements, while allowing optimum airflow and visibility
- 12.7 cm tall

» 2884746

PRO R/4 '22-24, TURBO R/4 '22-24, PRO XP/4 '20-24

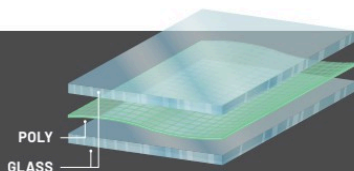

POLY
GLASS

GLASS VS HARD COAT POLY

Superior optical clarity (automotive level)
Scratch-resistant
Seals tight
Cold weather/heavy duty

Lightweight, flexible, easy to store/remove
Impact-resistant
30x more scratch resistance than regular poly windshields

HARD COAT POLY

REAR PANEL

POLY REAR PANEL TOP SELLER

- Drape formed 3mm polycarbonate for lightweight, impact-resistant durability
- Maintains rear visibility and reduces rear air swirl from entering the cockpit
- If installed, Rear Audio Pods should project backwards

» **TURBO R** **PRO XP**

2-SEAT

2883757

TURBO R '22-24,

PRO XP '20-24

» **PRO R**

2-SEAT NOT SHOWN

2884352

PRO R '22-24

4-SEAT NOT SHOWN

2884147

TURBO R 4 '22-24,

PRO XP 4 '20-24

» **PRO R**

4-SEAT NOT SHOWN

2884594

PRO R 4 '22-24

> ROOFS

POLY

POLY SPORT ROOF

- Durable, lightweight polypropylene with contoured design for water run-off
- Maximum protection with full seal for a leak-free barrier and reduced chatter

TURBO R	PRO XP	
COLOR	2-SEAT	4-SEAT <small>NOT SHOWN</small>
 MATTE BLACK	2883928	2883946
	TURBO R '22-24, PRO XP '20-24	TURBO R 4 '22-24, PRO XP 4 '20-24

ALUMINUM

- High protection strength
- Lower profile
- Sleek style

VS

POLY



- Water run-off
- Pre-existing mounting features
- Lightweight



ALUMINUM

ALUMINUM ROOF TOP SELLER

- .32 cm lightweight aluminum stamped sheet with full seal for a leak-free barrier and vibration elimination
- Quick install, low-profile design with maximum protection and durability from the harshest conditions

TURBO R	PRO XP	
COLOR	2-SEAT	4-SEAT <small>NOT SHOWN</small>
 MATTE BLACK	2883743-458	2883990-458
 INDY RED	2883743-293	2883990-293
	TURBO R '22-24, PRO XP '20-24	TURBO R 4 '22-24, PRO XP 4 '20-24

Matte Black stock on Turbo R/4 Premium/Ultimate



PRO R

COLOR	2-SEAT	4-SEAT
 MATTE BLACK	2884237-458	2884325-458
	PRO R '22-24	PRO R 4 '22-24



LIGHT POCKET ALUMINUM ROOF TOP SELLER

- .32 cm lightweight aluminum stamped sheet with full seal for a leak-free barrier and vibration elimination
- Low-profile with light pocket
- Quick installation with maximum protection and durability from the harshest conditions
- Not compatible with Full Vented Windshield - Glass (2889109) or Tip Out Windshield - Hard Coat Poly (2889536)

TURBO R	PRO XP	
COLOR	2-SEAT	4-SEAT <small>NOT SHOWN</small>
 MATTE BLACK	2883961-458	2883991-458
	TURBO R '22-24, PRO XP '20-24	TURBO R 4 '22-24, PRO XP 4 '20-24



ADD THE 71.12 cm RIGID SINGLE ROW LED LIGHT BAR, WHICH FITS PERFECTLY INTO THE ROOF POCKET. SEE P. 32 FOR MORE DETAILS

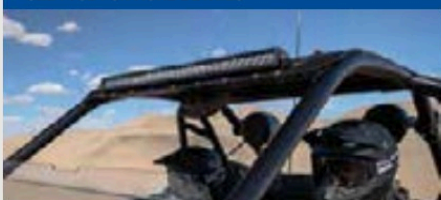

> DOORS

DOOR CLOSEOFFS

- Lightweight plastic door closeoffs provide riders protection from mud, rocks and water
- Quick installation and seamless fit into door opening
- Retains front ventilation

» 2883765

PRO R '22-24, TURBO R '22-24, PRO XP '20-24
STANDARD ON 4-SEAT, PREMIUM/ULTIMATE MODELS

ALUMINUM DOORS

- 12-gauge thick, stamped aluminum with full lower coverage and seal to keep out water, mud, dust and debris
- Uses factory door frames, with 4-Seat option providing an additional seal between front and rear doors
- Compatible with Front Door Inner Closeoff Panels (2884658, 2884831) and Upper Doors (2884664, 2884665)

COLOR	2-SEAT <small>NOT SHOWN</small>	4-SEAT
■ MATTE BLACK	2884659-458 PRO R '22-24, TURBO R '22-24, PRO XP '20-24	2884660-458 PRO R 4 '22-24, TURBO R 4 '22-24, PRO XP 4 '20-24 Not compatible with Low Profile Rock Sliders (2883987)

CHOOSE YOUR DOOR

ADD DOOR ACCESSORIES

FRONT DOOR INNER CLOSEOFF PANELS

- Vacuum formed polyethylene with full lower coverage and seal that keeps out water, mud, dust and debris
- Built-in armrest
- 2-Seat option maintains color accent boomerang
- Compatible with Door Closeoffs (2883765) and Aluminum Doors (2884659-458, 2884660-458)

» 2-SEAT • 2884658

PRO R '22-24, TURBO R '22-24, PRO XP '20-24
Not compatible with Rock Sliders (2883760, 2883987)

» 4-SEAT • 2884831 NOT SHOWN

PRO R 4 '22-24, TURBO R 4 '22-24, PRO XP 4 '20-24
Not compatible with Rock Sliders (2883987, 2883988)

UPPER DOORS

- High quality compression molded doors nest into thermoformed high-density polyethylene side shrouds for excellent sealing
- Includes zip-down 30-gauge clear vinyl windows
- Provides profiled cab edge for superior fit and finish
- Includes seals for key closeoff areas

» TURBO R PRO XP 2-SEAT • 2884664

TURBO R '22-24, PRO XP '20-24

» TURBO R PRO XP 4-SEAT • 2884665 NOT SHOWN

TURBO R 4 '22-24, PRO XP 4 '20-24

Some drivers may experience passenger side mirror obstruction when used with Upper Doors. Use with caution.

> HEATER

HEATER KIT

- Connects to Polaris PULSE bus bar to provide reliable, steady heat to your cab with fan speed and temperature control
- Closeable driver and passenger floor vents and electronic demist vent shutoff

» PRO XP 2884386

PRO XP/4 '20-24

RZR PRO R, TURBO R & PRO XP

> BUMPERS / FENDER FLARES

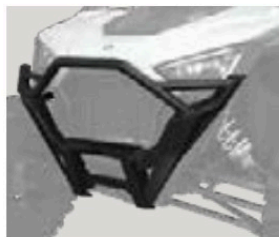

LOW PROFILE BUMPER

• Durable, powder-coated 3.8 cm - 4.5 cm tube steel with sleek lower profile

COLOR	PRO XP	
	FRONT	REAR
MATTE BLACK	2883746-458	2883748-458
INDY RED	2883746-293	2883748-293
BLUE METALLIC	2883746-751	NA
	PRO XP/4 '20-24	TURBO R/4 '22-24, PRO XP/4 '20-24

Bumper Bracket (2889566) required for Front Low Profile Bumper (2883746-XXX) when used on Pro XP/4 Sport '22-24

HIGH COVERAGE BUMPER TOP SELLER

• Durable 12-gauge, powder-coated steel with extended high-coverage design for maximum vehicle protection

COLOR	PRO XP	
	FRONT	REAR
MATTE BLACK	2883749-458	2884189-458
INDY RED	2883749-293	2884189-293
	PRO XP/4 '20-24	TURBO R/4 '22-24, PRO XP/4 '20-24



PRE RUNNER BUMPER

• Durable, powder-coated 1.5" steel tube

COLOR	PRO XP	
	FRONT	REAR
MATTE BLACK	2884581-458	2884585-458
	PRO XP/4 '20-24 Not compatible with a winch	TURBO R/4 '22-24, PRO XP/4 '20-24

INTEGRATED WINCH SEE P. 37

RIGID 15.24 cm LIGHT BAR SEE P. 32

Next-level style and function. Front bumpers are designed to effortlessly integrate a winch or 15.2 cm RIGID light bar.



FULL COVERAGE FENDER FLARES

- Covers the rear body opening to prevent mud from flying into the vehicle
- Maximum protection with 15.2 cm of additional coverage and extended, removable mud flaps
- Front and rear included

» 2884685

PRO R/4 '22-24, TURBO R/4 '22-24, PRO XP/4 '20-24



HIGH COVERAGE BUMPER TOP SELLER

- Durable 10-gauge, powder-coated 4.5 cm tube steel
- Compatible with winch or 6" light bar, both sold separately

	PRO R	TURBO R	PRO R
COLOR	FRONT		REAR
■ MATTE BLACK	2884353-458		2884356-458
	PRO R/4 '22-24, TURBO R/4 '22-24		PRO R/4 '22-24

PRE RUNNER BUMPER

- Durable, powder-coated 3.8 cm steel tube

	PRO R	TURBO R	PRO R
COLOR	FRONT		REAR
■ MATTE BLACK	2884354-458		2884358-458
■ INDY RED	2884354-293		2884358-293
	PRO R/4 '22-24, TURBO R/4 '22-24		PRO R/4 '22-24
	Not compatible with a winch		

PRE RUNNER WINCH BUMPER

- Durable, powder-coated 3.8 cm steel tube
- Requires winch (2884340, 2884341), sold separately

	PRO R	TURBO R
COLOR	FRONT	
■ MATTE BLACK	2884355-458	
■ INDY RED	2884355-293	
	PRO R/4 '22-24, TURBO R/4 '22-24	



> ROCK SLIDERS



12-GAUGE STAMPED STEEL
NO LOSS IN GROUND CLEARANCE

LOW PROFILE

	2-SEAT	4-SEAT
■ MATTE BLACK	2883760-458	2883987-458
■ INDY RED	2883760-293	2883987-293
	PRO R '22-24, TURBO R '22-24, PRO XP '20-24	PRO R 4 '22-24, TURBO R 4 '22-24, PRO XP 4 '20-24



4.5 cm STEEL TUBE CONSTRUCTION WITH
70% THICKER WALLS, EXTENDS FROM MACHINE FOR
MAX PROTECTION THROUGH ROUGH TERRAIN

HD EXTREME KICK-OUT TOP SELLER

	2-SEAT	4-SEAT
■ MATTE BLACK	2889208-458	2889209-458
■ INDY RED	2889208-293	2889209-293
	PRO R '22-24, TURBO R '22-24, PRO XP '20-24	PRO R 4 '22-24, TURBO R 4 '22-24, PRO XP 4 '20-24

**SEAMLESS
INSTALLATION**

Reusable anchors allow for easy installation of rock sliders into the built-in, dedicated chassis location.



CLOSED/UNLOCKED



OPEN/LOCKED

All Rock Sliders: Only compatible with Aluminum Doors (2884660-458, 2884659-458) when door seal is removed.
Not compatible with Front Door Inner Closeoff Panels (2884658, 2884631)

RZR PRO R, TURBO R & PRO XP

> LIGHTING



ADVANCED TECH

RIGID® lights are driven by Aluminum PCB Smart Boards®, 6063-T5 aircraft aluminum extruded housings and Tiger Drylac® UV protection polyester powdercoating.

EXCLUSIVE OPTICS

RIGID® invests heavily in optical science and has patented multiple optics and optics systems, maximizing light output and efficiency.

LIGHT BAR OPTIONS

1. CHOOSE YOUR LIGHT BAR

1,200 m
960 m
720 m
480 m
240 m



BRAND RIGID
SIZE 15.2 CM
TYPE DUAL-ROW E-SERIES
RAW LUMENS 9,504
PN 2884649
FITMENT PRO R/4 '22-24, TURBO R/4 '22-24, PRO XP/4 '20-24



MOUNTS IN WINCH POCKET FOR SEAMLESS INTEGRATION IN FRONT BUMPERS



TURBO R **PRO XP**
BRAND RIGID
SIZE 71.1 CM
TYPE SR-SERIES
RAW LUMENS 17,556
PN 2884074
FITMENT TURBO R/4 '22-24, PRO XP/4 '20-24

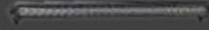

DESIGNED FOR USE WITH LIGHT POCKET ALUMINUM ROOF



BRAND RIGID
SIZE 81.3 CM
TYPE SR-SERIES
RAW LUMENS 20,064
PN 2884648
FITMENT PRO R/4 '22-24, TURBO R/4 '22-24, PRO XP/4 '20-24



MOUNTS TO ROOF FOR MAXIMUM VISIBILITY

2. ADD A MOUNT

MOUNT OPTIONS

15.2 CM LIGHT BAR MOUNT

PRO XP
» 2884654
PRO XP/4 '20-24

PRO R **TURBO R**
» 2884595
PRO R/4 '22-24,
TURBO R/4 '22-24

71.1 CM LIGHT BAR MOUNT

TURBO R **PRO XP**
MOUNT INCLUDED WITH LIGHT

81.3 CM LIGHT BAR MOUNT

TURBO R **PRO XP**
» 2884650
TURBO R/4 '22-24,
PRO XP/4 '20-24

PRO R
» 2884601
PRO R/4 '22-24

3. ADD A HARNESS

HARNESS OPTIONS

LIGHT BAR SET-UPS

MODEL	1 LIGHT IN 1 LOCATION on 1 SWITCH	2 LIGHTS IN 2 LOCATIONS on 2 SWITCHES
PRO R / 4 '22-24 TURBO R / 4 '22-24 PRO XP / 4 '20-24	POLARIS PULSE LIGHT BAR HARNESS 2883949	POLARIS PULSE LIGHT BAR HARNESS (x2) 2883949
	POLARIS PULSE HD LIGHT BAR HARNESS 2889130 FOR LIGHTS THAT DRAW OVER 10A	POLARIS PULSE HD LIGHT BAR HARNESS (x2) 2889130 FOR LIGHTS THAT DRAW OVER 10A



RIGID CHASE LIGHT

- Bright, daylight visible lighting with eleven selectable modes, including white scene lighting for accessing cargo bed in the dark
- Connects into brake light system for additional high mount brake light

» 2884359

PRO R/4 '22-24, TURBO R/4 '22-24,
PRO XP/4 '20-24



ACCENT LIGHT

- Durable construction resists dust and water while on the trails
- Front fascia LED accent light

» 2884346

PRO R/4 '22-24, TURBO R/4 '22-24,
PRO XP/4 '20-24
STANDARD ON PREMIUM/ULTIMATE MODELS

**POLARIS ENGINEERED
ADVANTAGES**

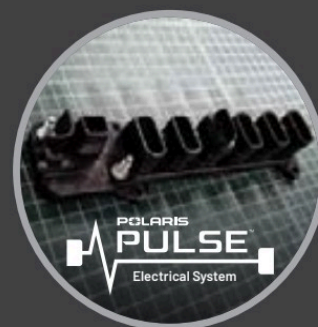

PLUG & PLAY ELECTRICAL

POLARIS PULSE IS A REVOLUTIONARY
way to provide power to your vehicle and makes
adding electrical accessories a snap.

CHASE LIGHT MOUNT KIT

» 2884896

PRO R/4 '22-24, TURBO R/4 '22-24,
PRO XP/4 '20-24

CHASE LIGHT

CHASE LIGHT HARNESS
2889034



SEE FULL LIGHTING OPTIONS P. 84

RZR PRO R, TURBO R & PRO XP



> STORAGE



FORWARD CARGO BOX

TOP SELLER

- Easy-to-use latches and molded side handles
- Durable polypropylene, engineered to seal out dust and water
- Lock & Ride strongly secures the box to the cargo bed

» **TURBO R** | **PRO XP**

69 L • 2883751

TURBO R/4 '22-24, PRO XP/4 '20-24

» **PRO R**

57 L • 2884235

PRO R/4 '22-24



Fit: 2 Full-Size Helmets | Tool Kit | Jacket/Coat | Food & Drinks

FORWARD CARGO AND REAR CARGO STORAGE BOXES NEST PERFECTLY TOGETHER



REAR CARGO BOX TOP SELLER

- Easy-to-use latches and molded side handles
- Durable polypropylene, engineered to seal out dust and water
- Lock & Ride strongly secures the box to the cargo bed

» **TURBO R** | **PRO XP**

40 L • 2883752

TURBO R/4 '22-24, PRO XP/4 '20-24

» **PRO R**

34 L • 2884236

PRO R/4 '22-24



Fit: Sleeping Bag | First Aid Kit | Snacks | Sunscreen

REAR CARGO STORAGE BOX AND 28 L NORTHSTAR COOLER NEST PERFECTLY TOGETHER



72 L MULTI-PASSENGER REAR SEAT CARGO BOX

- Single wall base and dual wall lid that seal out dust and water
- Lock & Ride mounting for easy installation and removal
- Includes a drain plug and mounting hardware, with a location to add a padlock for increased security
- Only compatible with flip forward/fold flat storage in Premium/Ultimate models
- Fits full size off-road vehicle helmet

» 2884666

PRO R/4 '22-24, TURBO R/4 '22-24, PRO XP/4 '20-24



PIVOTING SPARE TIRE CARRIER TOP SELLER

- Secure mounting with dual latches
- Steel mounts and rack
- Holds up to a 33" tire and supports 34 kg of weight
- Single-handed release mechanism

» **TURBO R** **PRO XP** 2889404-458

TURBO R/4 '22-24, PRO XP/4 '20-24

» **PRO R** 2884326-458

PRO R/4 '22-24

Not compatible with both Rear Speaker Pods (2883945) and Poly Rear Panel (part number varies by model)



28 L REAR COOLER

- Lid locks securely in place with rubber latches to protect cargo
- Provides plenty of storage without weighing you down
- Keeps your food, beverages and bait fresh while out on the trails
- Nests with forward cargo box

» 2889740

PRO R/4 '22-24, TURBO R/4 '22-24, PRO XP/4 '20-24



POLARIS NORTHSTAR 28 L COOLER

- Nests with rear cargo box

» GRAPHITE • 2883424



» SAGEBRUSH GREEN • 2890706

PRO R/4 '22-24, TURBO R/4 '22-24, PRO XP/4 '20-24



NORTHSTAR 28 L COOLER BRACKET

» **TURBO R** **PRO XP** 2884070

TURBO R/4 '22-24, PRO XP/4 '20-24

» **PRO R** 2889200

PRO R/4 '22-24

Not compatible with Pivoting Spare Tire Carrier (2889404-458, 2884326-458)

SEE P. 104 FOR FULL DETAILS



9.5 L SHOULDER STORAGE BAG

- Keeps your belongings safe and secure
- Molded sides, lid inserts, waterproof zipper and a nylon mesh pocket for versatile storage options
- Easy install and quick access with a sleek cockpit look

» 2889785

PRO R/4 '22-24, TURBO R/4 '22-24, PRO XP/4 '20-24

Fits between rear seats on 4-Seat models



Fit: Flashlight | Snacks | Sunglasses | Bug Spray

7.25 L DOOR STORAGE BAG

- Quick reach access to keep supplies and gear secure
- Waterproof zipper keeps everything enclosed, clean and dry
- Molded face with EVA carbon fiber vinyl cover design

» 2889784

PRO R/4 '22-24, TURBO R/4 '22-24, PRO XP/4 '20-24

Compatible with front doors only

Not compatible with Front Door Inner Closeoff Panels (2884658, 2884831)

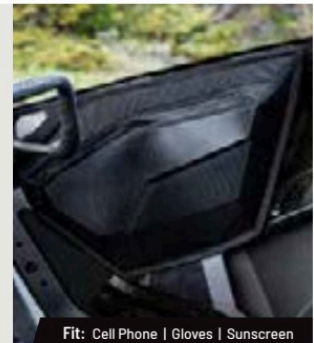

Fit: Cell Phone | Gloves | Sunscreen

RZR PRO R, TURBO R & PRO XP



> MISC

S&B PARTICLE SEPARATOR

- Separates over 94% of dust before it reaches the air filter
- Integrated hidden design in the fender to stay out of sight
- Variable fan based on engine speed to keep noise levels low

» **PRO XP** 2884629

PRO XP/4 '20-24

ORDERABLE THROUGH LOCAL DEALER ONLY



SECONDARY BATTERY MOUNT KIT

- Provides longer lasting 12V output
- Battery sold separately

» 2884347

PRO R '22-24, TURBO R '22-24, PRO XP '20-24

STANDARD ON PRO R/4 PREMIUM/ULTIMATE MODELS

» 2884391

PRO R 4 '22-24, TURBO R 4 '22-24, PRO XP 4 '20-24

STANDARD ON PRO R/4 PREMIUM/ULTIMATE MODELS



> MIRRORS

ADJUSTABLE FOLDING SIDE MIRRORS

- Installs in minutes and integrates into a designated mounting position
- Laminated safety glass for excellent scratch resistance

» 2883762

PRO R/4 '22-24, TURBO R/4 '22-24, PRO XP/4 '20-24



PREMIUM CONVEX REARVIEW MIRROR TOP SELLER

- Installs in minutes and integrates into a designated mounting position
- Laminated safety glass for excellent scratch resistance

» 2883763

PRO R/4 '22-24, TURBO R/4 '22-24, PRO XP/4 '20-24





> WINCHES



FEATURES		PRO PRO HEAVY DUTY SERIES	
RAPID ROPE RECOVERY	STANDARD		
AUTO STOP TECHNOLOGY	STANDARD		
WINCH LINE	SYNTHETIC ROPE		
CONTROL	WIRELESS & WIRED STANDARD		
MODEL	2,721 kg	2,041 kg	REPLACEMENT PARTS
PRO R / TURBO R PRO R / 4 '22-24 TURBO R / 4 '22-24 Includes both wired and wireless remote	2884341	2884340	15 M SYNTHETIC ROPE 2,721 kg SERIES » 2879188 2,041 kg SERIES » 2879187
PRO XP PRO XP / 4 '20-24 Includes both wired and wireless remote	2883759	TOP SELLER 2883758	



RZR XP

POLARIS
RZR XP

**BEST-SELLING PERFORMANCE
SIDE-BY-SIDE**



..... RIGID CHASE LIGHT
SEE P. 52

> TERRAIN VERSATILITY

Developed to take on various landscapes, so you can confidently get anywhere.

PROTECTION P. 50
RIGID LIGHTING P. 52
PRO ARMOR WHEELS & TIRES P. 88

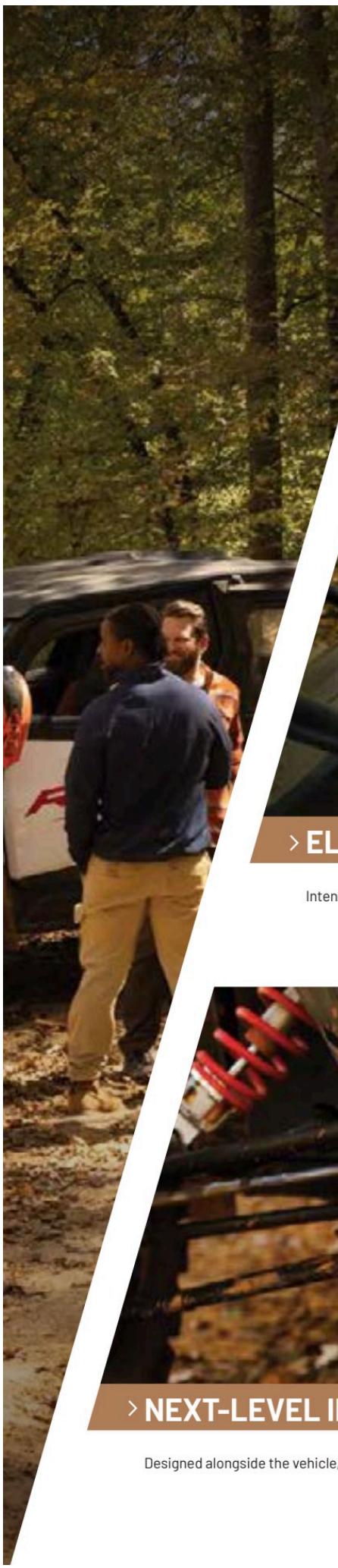

> ELEVATED CRAFTSMANSHIP

Intentional styling that puts quality and compatibility first.

REAR PANELS P. 47
UPPER DOORS P. 49
STORAGE P. 54
COOLERS P. 104

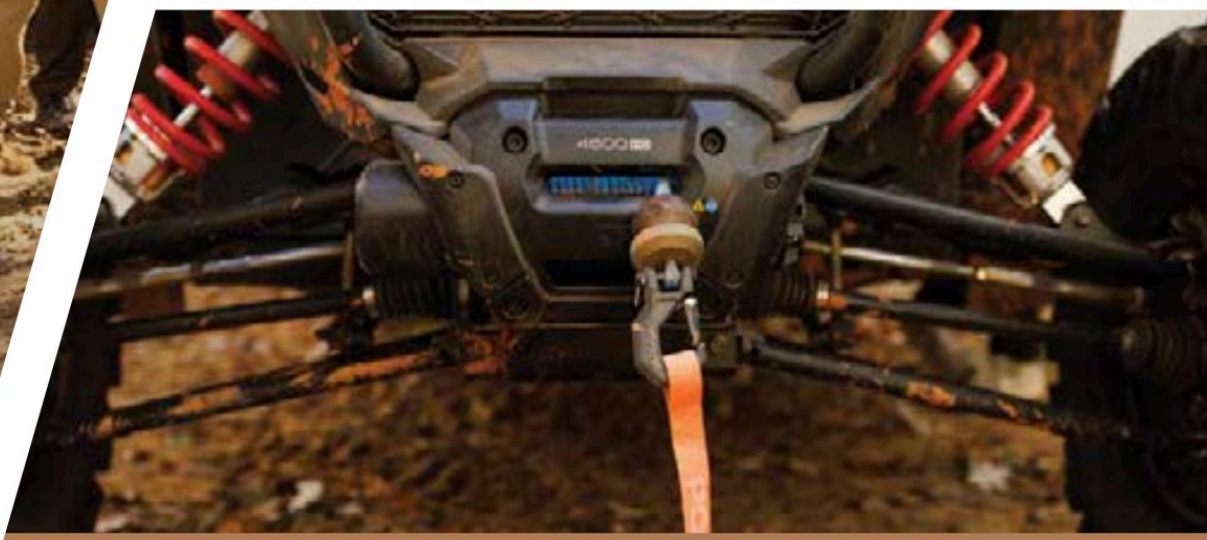

> NEXT-LEVEL INTEGRATION

Designed alongside the vehicle, to allow for seamless installation on your ride.

ROCKFORD FOSGATE AUDIO P. 44
WINDSHIELDS P. 47
ROOFS P. 48
WINCHES P. 57



▶ TRAIL COLLECTION

Navigate the trails through forests, hills and plains.

- | | | | |
|-------------|---|-------------|--|
| 2884542 | LR LA RIDE Full Vented Windshield - Hard Coat Poly: P. 47 | 2889121 | Chase Light Mount Kit: P. 52 |
| 2884519 | LR LA RIDE Poly Rear Panel: P. 47 | 2889293 | Chase Light Harness Kit: P. 52 |
| 2884513-293 | Front High Coverage Bumper: P. 50 | 2884649 | RIGID® E-Series 15.2 cm Light Bar: P. 52 |
| 2884514-293 | Rear High Coverage Bumper: P. 50 | 2884510 | 15.2 cm Light Bar Mount: P. 52 |
| 2884512-293 | HD Extreme Kick-Out Rock Sliders, 4-Seat: P. 51 | 2884530 | 8 L Shoulder Storage Bag: P. 54 |
| 2889133 | Full Coverage Fender Flares: P. 51 | 2884528 | 4.7 L Door Storage Bag: P. 54 |
| 2883763 | Premium Convex Rearview Mirror: P. 56 | 2884548 | Tonneau Cover: P. 55 |
| 2884524 | Adjustable Folding Side Mirrors: P. 56 | 2884546-458 | Pivoting Spare Tire Carrier: P. 55 |
| 2884562 | Stage 4 Audio Upgrade by Rockford Fosgate®: P. 44 | 2884836 | Polaris Pro HD 2,041 kg Winch: P. 57 |
| 2884648 | RIGID® SR-Series 81.3 cm Combo LED Light Bar: P. 52 | 2889555 | Pro Armor Wheel & Tire Set:
4302 Beadlock & Crawler XG, 30": P. 102 |
| 2884650 | 81.3 cm Light Bar Mount: P. 52 | 5415616 | Pro Armor Spare Tire: Crawler XG, 30": P. 95 |
| 2889291 | Polaris PULSE Light Bar Harness: P. 52 | 5418036 | Pro Armor Spare Wheel: 4302 Beadlock, 14": P. 101 |
| 2884359 | RIGID® Chase Light: P. 52 | | |

> MUD COLLECTION

Power through the deepest ruts and wear the mud as a badge of honor.

- 2884539 **LR RIGID** Half Windshield - Hard Coat Poly: P. 47
- 2884513-458 Front High Coverage Bumper: P. 50
- 2884514-458 Rear High Coverage Bumper: P. 50
- 2889133 Full Coverage Fender Flares: P. 51
- 2883763 Premium Convex Rearview Mirror: P. 56
- 2884561 Stage 2 Audio Upgrade by Rockford Fosgate®: P. 44
- 2889292 Stage 3 Audio Upgrade by Rockford Fosgate®*: P. 44
- 2884562 Stage 4 Audio Upgrade by Rockford Fosgate®: P. 44
- 2883945 Rear Speaker Pods by Rockford Fosgate®: P. 44
- 2884648 RIGID® SR-Series 81.3 cm Combo LED Light Bar: P. 52

- 2884650 81.3 cm Light Bar Mount: P. 52
- 2889291 Polaris PULSE Light Bar Harness: P. 52
- 2884525 **LR LOCK STRIDE** 52 L Rear Cargo Box: P. 54
- 2883424 Polaris NorthStar 28 L Cooler: P. 55
- 2884526 **LR RIGID** NorthStar 28 L Cooler Bracket: P. 55
- 2884530 8 L Shoulder Storage Bag: P. 54
- 2884528 4.7 L Door Storage Bag: P. 54
- 2884836 Polaris Pro HD 2,041 kg Winch: P. 57
- 2890165 Pro Armor Wheel & Tire Set:
5305 Beadlock & Mud XC, 30": P. 102



Shown on XP 2-Seat.
*Stage 3 Audio Upgrade comes stock on Ultimate models.



➤ BACKCOUNTRY COLLECTION

Get off the beaten path and make the ride part of the adventure.

- 2884542  Full Vented Windshield - Hard Coat Poly: P. 47
- 2884549-293 Aluminum Roof, 2-Seat: P. 48
- 2884472-293 Low Profile Rock Slider, 2-Seat: P. 51
- 2883763 Premium Convex Rearview Mirror: P. 56
- 2884524 Adjustable Folding Side Mirrors: P. 56
- 2889614 Stage 5 Audio Upgrade by Rockford Fosgate®: P. 44
- 2884648 RIGID® SR-Series 81.3 cm Combo LED Light Bar: P. 52
- 2884650 81.3 cm Light Bar Mount: P. 52
- 2889291 Polaris PULSE Light Bar Harness: P. 52

- 2884359 RIGID® Chase Light: P. 52
- 2889121 Chase Light Mount Kit: P. 52
- 2889293 Chase Light Harness Kit: P. 52
- 2889611  78 L Forward Cargo Box: P. 54
- 2889612  28 L Rear Cooler: P. 55
- 2884530 8 L Shoulder Storage Bag: P. 54
- 2885030 Pro Armor Wheel & Tire Set: 5204 & Pro Runner, 30": P. 103

> ALL-SEASON COLLECTION

Take advantage of any season with year-round riding.

2884545	Full Vented Windshield - Glass: P. 47
2884579	Windshield Wiper - Washer Kit: P. 47
2884519	LR ROPS Poly Rear Panel: P. 47
2884554	Poly Sport Roof, 4-Seat*: P. 48
2884534	Upper Doors, 4-Seat: P. 49
2884513-458	Front High Coverage Bumper: P. 50
2884514-458	Rear High Coverage Bumper: P. 50
2884512-458	HD Extreme Kick-Out Rock Sliders, 4-Seat: P. 51
2889133	Full Coverage Fender Flares: P. 51

2883763	Premium Convex Rearview Mirror: P. 56
2884524	Adjustable Folding Side Mirrors: P. 56
2884523	Heater Kit: P. 49
2885003	Stage 1 Audio Kit by Rockford Fosgate***: P. 44
2884528	4.7 L Door Storage Bag: P. 54
2884548	Tonneau Cover: P. 55
2884835	Polaris HD 2,041 kg Winch: P. 57
2883166	Pro Armor Wheel & Tire Set: 5202 & Attack 2.0, 30": P. 102

Shown on XP 4-Seat.
*Poly Sport Roof comes stock on Premium/Ultimate models.
**Stage 1 Audio Kit comes stock on Premium models; not compatible with Ultimate models.

> AUDIO



Rockford Fosgate partnered with Polaris to create the next evolution of factory-installed off-road audio. Purpose-built to stand up to any outdoor environment and designed to perform no matter the ride. Specifically tuned and rider-centric to create an audio experience that is second to none.



PLUG & PLAY



ELEMENT READY



NO LOSS OF CARGO SPACE



BLUETOOTH

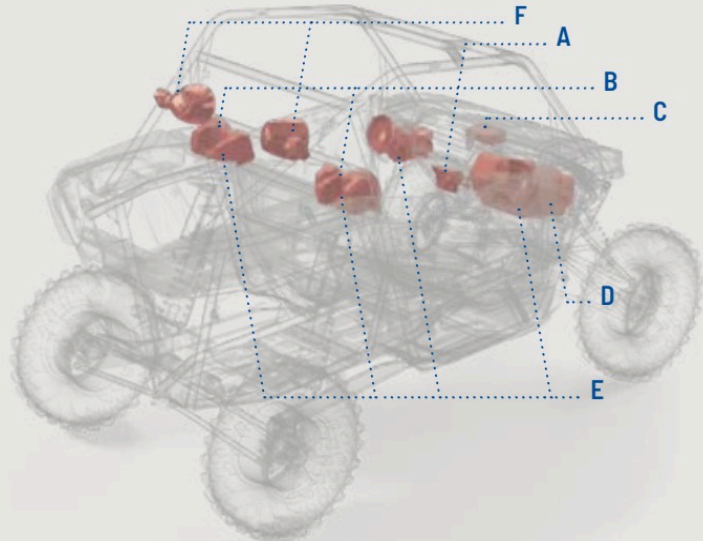

SOURCE UNITS

- Tuned to combat wind and motor noise, delivering an incredible sound no matter the speed
- Element ready design guards against dust and moisture intrusion

AMPLIFIERS

- Ultra compact CLEAN technology
- Highly efficient design capable of being pushed hard without overheating

SPEAKERS

- Off-road optimized Element Ready speakers thrive in any outdoor environment
- Specifically tuned enclosures create rich cockpit sound
- Rugged, yet lightweight, materials that don't sacrifice speed for sound

SUBWOOFERS

- High-power, high-excursion subwoofer that acoustically couples with the cockpit for perfect bass response
- Torture tested to ensure long life and performance



A. STAGE 1 PMX-P2 HEAD UNIT & 16.51 CM DASH SPEAKERS

- 6.86 cm full color display
- AM/FM/WB tuner*, Pandora control, Bluetooth connectivity
- Includes mount kit
- 50 watt 16.51 cm coaxial speakers with enclosures

» 2885003
XP/4 '24
STANDARD ON PREMIUM MODELS.
NOT COMPATIBLE WITH ULTIMATE MODELS



B. STAGE 2 16.51 CM REAR SPEAKERS

- 50 watt 16.51 cm component speakers including tweeters with enclosures

» 2884561
XP/4 '24
STANDARD ON ULTIMATE MODELS



C. STAGE 3 AMPLIFIER UPGRADE KIT

- 400 watt full range amplifier

» 2889292
XP/4 '24
STANDARD ON ULTIMATE MODELS



D. STAGE 4 25.4 CM POWERED SUBWOOFER

- 25.4 cm subwoofer with enclosure and grille
- 400 watt integrated subwoofer amplifier

» 2884562
XP/4 '24
Stage 3 Audio (2889292) required, sold separately
Not compatible with Stage 5 Audio



E. STAGE 5 30 CM POWERED SUBWOOFER WITH FULL SYSTEM SPEAKER UPGRADE

- 400 watt 30 cm subwoofer with enclosure and grille
- 100 watt dash speakers (x2)
- 100 watt rear speakers with enclosures and stainless steel grilles
- 2x more power and sound delivery over the stock system

» 2889614
XP/4 '24
Stage 3 Audio (2889292) required, sold separately
Not compatible with Stage 4 Audio or Rear Pods



F. REAR PODS USE WITH STAGES 1-4

- 50 watt 16.51 cm coaxial speakers with can-enclosures, mounting hardware and grilles

» 2883945
XP/4 '24
Not compatible with Stage 5 Audio Upgrade (2889614)



XP

AUDIO

WINDSHIELDS & REAR PANELS

ROOF, DOORS & HEATER

VEHICLE PROTECTION

LIGHTING

STORAGE

MIRRORS & WINCHES

2014-2023 XP 1000, XP TURBO & TURBO S

BUILD YOUR SOUND

(CHOOSE THE PATH THAT MATCHES YOUR RZR)

FACTORY-INSTALLED

SKIP TO STEP 2



XP PREMIUM

PMX-P2 + STAGE 1



XP ULTIMATE

RIDE COMMAND + STAGE 3

NO FACTORY AUDIO

STEP 1

ADD BASE AUDIO

STAGE 1

PMX-P2 HEAD UNIT & 16.51 CM DASH SPEAKERS
2885003
XP/4 '24
STANDARD ON PREMIUM MODELS
NOT COMPATIBLE WITH ULTIMATE MODELS

STEP 2

UPGRADE AUDIO

STAGE 2

16.51 CM REAR SPEAKERS
2884561
XP/4 '24
STANDARD ON ULTIMATE MODELS

+ / OR

STAGE 3

AMPLIFIER UPGRADE KIT
2889292
XP/4 '24
STANDARD ON ULTIMATE MODELS

+ / OR

REAR PODS

2883945
XP/4 '24
Not compatible with Stage 5 Audio Upgrade (2889614)
ADD TO STAGES 1-4

STEP 3

CRANK THE BASS

STAGE 4

25.4 CM POWERED SUBWOOFER
2884562
XP/4 '24
Stage 3 Audio (2889292) required, sold separately
NOT COMPATIBLE WITH STAGE 5 AUDIO

OR

STAGE 5

30 CM POWERED SUBWOOFER WITH FULL SYSTEM SPEAKER UPGRADE
2889614
XP/4 '24
Stage 3 Audio (2889292) required, sold separately
NOT COMPATIBLE WITH STAGE 4 AUDIO OR REAR PODS

RZR XP



> BUILD YOUR CAB

ADD COMFORT AND STYLE WITH END-TO-END PROTECTION



ADD A ROOF

Shield from harsh elements while adding style.

ADD A REAR PANEL

Maintain rear visibility while reducing rear air swirl.

ADD A WINDSHIELD

Protect all riders with optical clarity.

ADD UPPER DOORS

Keep the cab free of debris and water.

RECOMMENDED 2-SEAT CAB

- 2884545 • Full Vented Windshield - Glass
- 2884579 • Glass Windshield Wiper Kit
- 2884519 • Poly Rear Panel
- 2884553 • Poly Sport Roof
- 2889402 • Exterior Door Latch

Available on 2-Seat and 4-Seat vehicles.

RECOMMENDED 4-SEAT CAB

- 2884545 • Full Vented Windshield - Glass
- 2884579 • Glass Windshield Wiper Kit
- 2884519 • Poly Rear Panel
- 2884551-458 • Aluminum Roof
- 2889402 • Exterior Door Latch
- 2889403 • Exterior Door Latch (Rear)

Available on 2-Seat and 4-Seat vehicles.

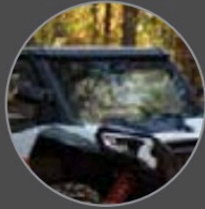

PROFILE ROPS

Provides a flat sealing surface for the glass windshield gasket and indentation along the A-pillar for optimized fit.



DASH GROOVE

Dedicated nesting location along the dash for windshields to rest, creating a tighter seal to eliminate air gaps.

POLARIS ENGINEERED ADVANTAGES

WINDSHIELDS

GLASS



FULL VENTED WINDSHIELD - GLASS

TOP SELLER

- Double-layer, laminated and tempered glass windshield with steel, powder-coated frame and adjustable center vents
- ECE R43 certified
- » 2884545
- XP/4 '24



GLASS WINDSHIELD WIPER KIT

TOP SELLER

- Simple to control with a multi-function, dash-mounted switch
- Includes a washer fluid reservoir
- » 2884579
- XP/4 '24
- Compatible with glass windshield only



HARD COAT POLY

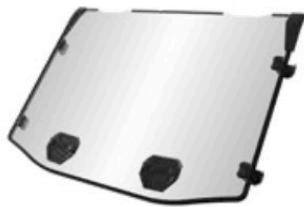

LR LOCK-TRIBE

FULL VENTED WINDSHIELD - HARD COAT POLY

- Impact-resistant, long-lasting .64 cm durable hard coated polycarbonate
- Full protection with airflow vents that quickly open for cockpit ventilation
- » 2884542
- XP/4 '24



LR LOCK-TRIBE

FULL WINDSHIELD - HARD COAT POLY

- Impact-resistant, long-lasting .64 cm durable hard coated polycarbonate
- No frame design offers maximum visibility
- Integrates with all cab components
- » 2884540
- XP/4 '24



LR LOCK-TRIBE

HALF WINDSHIELD - HARD COAT POLY

TOP SELLER

- Provides added protection from the elements, while allowing optimum airflow and visibility
- 18 cm tall
- » 2884539
- XP/4 '24

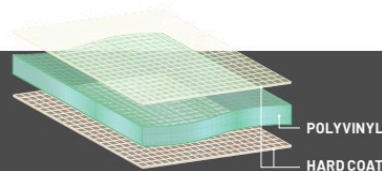
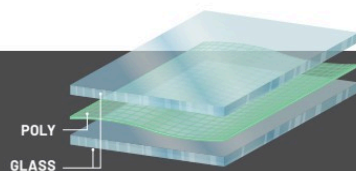

GLASS VS HARD COAT POLY

Superior optical clarity (automotive level)
Scratch-resistant
Seals tight
Cold weather/heavy duty

Lightweight, flexible, easy to store/remove
Impact-resistant
30x more scratch resistance than regular poly windshields

REAR PANEL

LR LOCK-TRIBE

POLY REAR PANEL

- Designed with a flat polycarbonate viewing area to maintain rearward visibility
- A thermoformed shroud seals the lower portion of the cab to reduce rear air swirl
- Compatible with all storage and the spare tire carrier
- » 2884519
- XP/4 '24
- Not compatible with Rear Speaker Pods (2883945)

XP

AUDIO

WINDSHIELDS & REAR PANELS

ROOF, DOORS & HEATER

VEHICLE PROTECTION

LIGHTING

STORAGE

MIRRORS & WINCHES

2014-2023 XP 1000, XP TURBO & TURBO S



> ROOFS

POLY

POLY SPORT ROOF

- Durable, lightweight polypropylene with contoured design for water run-off
- Maximum protection with full seal for a leak-free barrier and reduced chatter

COLOR	2-SEAT	4-SEAT <small>NOT SHOWN</small>
■ MATTE BLACK	2884553	2884554
	XP '24	XP 4 '24

ALUMINUM

VS

POLY

- High protection strength
- Lower profile
- Sleek style

- Water run-off
- Pre-existing mounting features
- Lightweight



ALUMINUM

ALUMINUM ROOF TOP SELLER

- .32 cm lightweight aluminum stamped sheet with full seal for a leak-free barrier and vibration elimination
- Quick install, low-profile design with maximum protection and durability from the harshest conditions

COLOR	2-SEAT	4-SEAT <small>NOT SHOWN</small>
■ MATTE BLACK	2884549-458	2884551-458
■ INDY RED	2884549-293	2884551-293
	XP '24	XP 4 '24





> DOORS



UPPER DOORS

- High quality compression molded doors nest into thermoformed high-density polyethylene side shrouds for excellent sealing
- Includes zip-down 30-gauge clear vinyl windows
- Provides profiled cab edge for superior fit and finish
- Includes external latches

COLOR	2-SEAT	4-SEAT <small>NOT SHOWN</small>
■ MATTE BLACK	2884533 XP '24	2884534 XP 4 '24



EXTERIOR DOOR LATCH KIT

- Makes opening doors from outside the vehicle easier
- Includes one latch per door
- » 2-SEAT • 2889402
XP '24
- » 4-SEAT • 2889403 NOT SHOWN
XP 4 '24

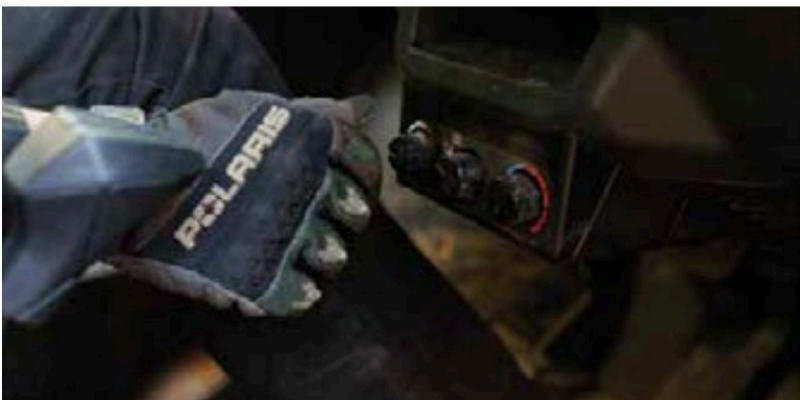

> HEATER

HEATER KIT

- Connects to Polaris PULSE bus bar and provides reliable, steady heat to your cab with fan speed and temperature control
- Select between in-cab heat, demist vents or both with a controllable knob
- » 2884523
XP/4 '24

XP

AUDIO

WINDSHIELDS
& REAR PANELS

ROOFS, DOORS
& HEATER

VEHICLE PROTECTION

LIGHTING

STORAGE

MIRRORS & WINCHES

2014-2023 XP 1000,
XP TURBO & TURBOS



> VEHICLE PROTECTION

BUMPERS



LOW PROFILE BUMPER TOP SELLER

• Durable, powder-coated 3.8 cm tube steel with sleek lower profile

COLOR	FRONT	REAR
■ MATTE BLACK	2884515-458	2884516-458
	XP/4 '24	XP/4 '24

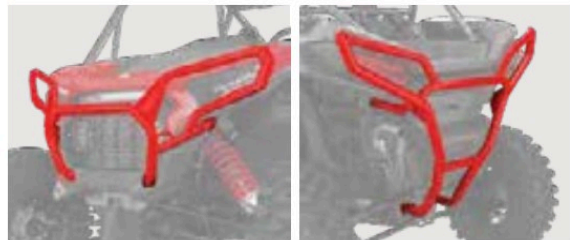

HIGH COVERAGE BUMPER

• Durable 3.8 cm tube steel with headlight bezels for maximum coverage

COLOR	FRONT	REAR
■ MATTE BLACK	2884513-458	2884514-458
■ INDY RED	2884513-293	2884514-293
	XP/4 '24 NOT COMPATIBLE WITH TRACTOR OR ZUG MODELS	XP/4 '24 NOT COMPATIBLE WITH TRACTOR OR ZUG MODELS

NEXT-LEVEL STYLE AND FUNCTION. FRONT BUMPERS ARE DESIGNED TO EFFORTLESSLY INTEGRATE A WINCH OR 15.2 CM RIGID LIGHT BAR



INTEGRATED WINCH

SEE P. 57



RIGID 15.24 CM LIGHT BAR

SEE P. 52



XP

AUDIO

WINDSHIELDS
& REAR PANELS

ROOF, DOORS
& HEATER

VEHICLE PROTECTION

LIGHTING

STORAGE

MIRRORS & WINCHES

2014-2023 XP 1000,
XP TURBO & TURBO S

ROCK SLIDERS



12-GAUGE STAMPED STEEL
NO LOSS IN GROUND CLEARANCE

LOW PROFILE

COLOR	2-SEAT	4-SEAT
■ MATTE BLACK	2884472-458	2884511-458
■ INDY RED	2884472-293	2884511-293
	XP '24	XP 4 '24

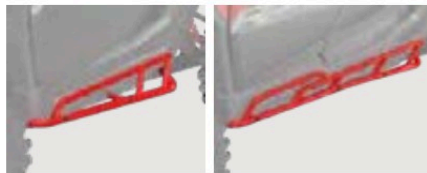

3.18 cm STEEL TUBE CONSTRUCTION FOR
MAX PROTECTION THROUGH ROUGH TERRAIN

HD EXTREME KICK-OUT

COLOR	2-SEAT	4-SEAT
■ MATTE BLACK	2884473-458	2884512-458
■ INDY RED	2884473-293	2884512-293
	XP '24	XP 4 '24

SEAMLESS INSTALLATION

Reusable anchors allow for
easy installation of rock
sliders into the built-in,
dedicated chassis location.



CLOSED/UNLOCKED



OPEN/LOCKED

FENDER FLARES & ARM GUARDS



FULL COVERAGE FENDER FLARES

- Replaces stock fender flares and provides additional coverage with factory styling
- Front and rear included

» 2889133

XP/4 '24

STANDARD ON TRACTOR AND ZUG VERSION

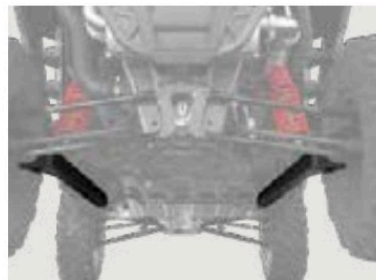

TRAILING ARM GUARDS

- Reliable protection for vital suspension components of your vehicle
- HDPE poly guard bolts to Trailing Arm Guards to protect against rock abrasions

» 2889442

XP/4 '24



NEW HIGH CLEARANCE SUSPENSION KIT

- Designed to optimize ground clearance
- Includes one set of high clearance front control arms and high clearance radius rods

» 2890853

XP/4 '24

> LIGHTING



ADVANCED TECH

RIGID® lights are driven by Aluminum PCB Smart Boards®, 6063-T5 aircraft aluminum extruded housings and Tiger Drylac® UV protection polyester powdercoating.

EXCLUSIVE OPTICS

RIGID® invests heavily in optical science and has patented multiple optics and optics systems, maximizing light output and efficiency.

LIGHT BAR OPTIONS

1. CHOOSE YOUR LIGHT BAR



BRAND	RIGID
SIZE	15.2 CM
TYPE	DUAL-ROW E-SERIES
RAW LUMENS	9,504
PN	2884649
FITMENT	XP/4 '24

Requires bumper, sold separately.



MOUNTS TO FRONT FASCIA WITH ACCESSORY BUMPER

BRAND	RIGID
SIZE	81.3 CM
TYPE	SR-SERIES
RAW LUMENS	20,064
PN	2884648
FITMENT	XP/4 '24

Requires roof, sold separately.

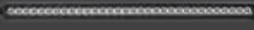

MOUNTS TO ROOF FOR MAXIMUM VISIBILITY

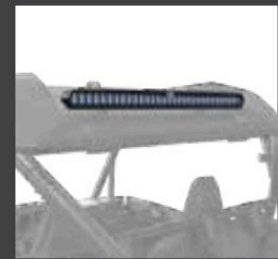

RIGID CHASE LIGHT

- Bright, daylight visible lighting with eleven selectable modes, including white scene lighting for accessing cargo bed in the dark
 - Connects into brake light system for additional high mount brake light
- » 2884359
XP/4 '24

2. ADD A MOUNT

MOUNT OPTIONS

15.2 CM LIGHT BAR MOUNT

» 2884510
XP/4 '24

81.3 CM LIGHT BAR MOUNT

» 2884650
XP/4 '24

CHASE LIGHT MOUNT KIT

» 2889121
XP/4 '24

3. ADD A HARNESS

HARNESS OPTIONS

MODEL	LIGHT BAR SET-UPS		CHASE LIGHT
	1 LIGHT IN 1 LOCATION ON 1 SWITCH	2 LIGHTS IN 2 LOCATIONS ON 2 SWITCHES	
XP / 4	POLARIS PULSE LIGHT BAR HARNESS 2889291	POLARIS PULSE LIGHT BAR HARNESS (X2) 2889291	CHASE LIGHT HARNESS 2889293

**POLARIS ENGINEERED
ADVANTAGES**



PLUG & PLAY ELECTRICAL

POLARIS PULSE IS A REVOLUTIONARY
way to provide power to your vehicle and
makes adding electrical accessories a snap.



ACCENT LIGHT KIT

- Durable construction resists dust and water while on the trails
- Front and rear LED accent lights

» 2889539

XP/4™24

STANDARD ON ULTIMATE MODELS



XP

AUDIO

WINDSHIELDS
& REAR PANELS

ROOF, DOORS
& HEATER

VEHICLE PROTECTION

LIGHTING

STORAGE

MIRRORS & WINCHES

2014-2023 XP 1000,
XP TURBO & TURBO S

RZR XP



> STORAGE

78 L FORWARD CARGO BOX

- Easy-to-use latches and molded side handles
- Durable polypropylene, engineered to seal out dust and water
- Lock & Ride strongly secures the box to the cargo bed

» 2889611
XP/4 '24



Fit: 2 Full-Size Helmets | Tool Kit | Jacket/Coat | Food & Drinks

FORWARD CARGO BOX NESTS PERFECTLY TOGETHER WITH REAR CARGO BOX OR 28 L REAR COOLER

52 L REAR CARGO BOX

- Easy-to-use latches and molded side handles
- Durable polypropylene, engineered to seal out dust and water
- Lock & Ride strongly secures the box to the cargo bed

» 2884525
XP/4 '24



Fit: Jacket/Coat | First Aid Kit | Snacks | Sunscreen

REAR CARGO BOX NESTS PERFECTLY TOGETHER WITH 28 L NORTHSTAR COOLER OR FORWARD CARGO BOX



Fit: Flashlight | Snacks | Sunglasses | Bug Spray

8 L SHOULDER STORAGE BAG

- Keeps your belongings safe and secure
- Molded sides and lid with dual YKK® zippers
- Easy install and quick access with a sleek cockpit look

» 2884530
XP/4 '24

Fits between rear seats on 4-Seat models

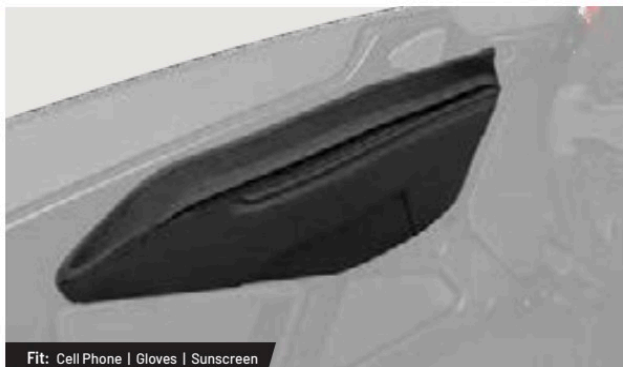

Fit: Cell Phone | Gloves | Sunscreen

4.7 L DOOR STORAGE BAG

- Quick reach access to keep supplies and gear secure
- Waterproof YKK® zippers keep everything enclosed, clean and dry

» 2884528

XP/4 '24
Compatible with front doors only



XP

AUDIO

WINDSHIELDS
& REAR PANELS

ROOF, DOORS
& HEATER

VEHICLE PROTECTION

LIGHTING

STORAGE

MIRRORS & WINCHES

2014-2023 XP 1000,
XP TURBO & TURBOS



28 L REAR COOLER

- Lid locks securely in place with rubber latches to protect cargo
- Provides plenty of storage without weighing you down
- Keeps your food, beverages and bait fresh while out on the trails
- Nests with forward cargo box

» 2889612
XP/4 '24



POLARIS NORTHSTAR 28 L COOLER

- Nests with rear cargo box
 - » GRAPHITE • 2883424
 - » SAGEBRUSH GREEN • 2890706
- XP/4 '24



NORTHSTAR 28 L COOLER BRACKET

» 2884526
XP/4 '24

SEE P. 104 FOR FULL DETAILS ON
POLARIS NORTHSTAR COOLERS



TONNEAU COVER TOP SELLER

- One cover seals the entire storage box
- Built-in friction hinge to stay open on its own

» 2884548
XP/4 '24

Not compatible with cargo boxes or coolers



PIVOTING SPARE TIRE CARRIER

- Secure mounting with dual latches and single-handed release mechanism
- Steel mounts and rack
- Holds up to a 32" tire and supports 34 kg of weight

» 2884546-458
XP/4 '24

SEE COVERS AND STRAPS P. 124

RZR XP



> MIRRORS



ADJUSTABLE FOLDING SIDE MIRRORS

- Left and right mirrors included
- Installs in minutes and integrates into a designed mounting position
- Laminated safety glass for excellent scratch resistance

» 2884524

XP/4*24

Not compatible with Upper Doors (2884533, 2884534)



PREMIUM CONVEX REARVIEW MIRROR TOP SELLER

- Installs in minutes and integrates into a designated mounting position
- Laminated safety glass for excellent scratch resistance

» 2883763

XP/4*24



> WINCHES

FEATURES	PRO PRO HEAVY DUTY SERIES	HD HEAVY DUTY SERIES
RAPID ROPE RECOVERY	STANDARD	NOT AVAILABLE
AUTO STOP TECHNOLOGY	STANDARD	OPTION
WINCH LINE	SYNTHETIC ROPE	SYNTHETIC ROPE
CONTROL	WIRED TOGGLE SWITCH & WIRELESS REMOTE STANDARD	WIRED TOGGLE SWITCH STANDARD, WIRED & WIRELESS REMOTE OPTIONAL
MODEL	2,041 kg	2,041 kg
XP / 4'24	2884836	2884835

REPLACEMENT PARTS

15 M SYNTHETIC ROPE

2,041 kg SERIES
» 2879187



AUTO STOP UPGRADE

- Replaces stock fairlead
- » 2889028
- Synthetic Rope & Wireless Remote (2889561), required

WIRED REMOTE CONTROL

- 1.8 m corded remote
- Direct plug & play operation
- » 2889562



WIRELESS REMOTE

- Up to 15 m range with LED indicator
- Direct plug & play operation
- » 2889561



SEE ADDITIONAL WINCH INFORMATION P. 108

2014-2023 RZR XP 1000, XP TURBO & TURBO S



> WINDSHIELDS

HARD COAT POLY

GLASS



LR LOCK RIDE FULL VENTED WINDSHIELD - HARD COAT POLY

- Impact-resistant, long-lasting .64 cm durable hard coated polycarbonate
 - Full protection with airflow vents that quickly open for cockpit ventilation
- » 2884330
XP TURBO/4 '19-21, XP 1000/4 '19-23



LR LOCK RIDE FULL WINDSHIELD - HARD COAT POLY **TOP SELLER**

- Durable, optical-grade polycarbonate provides maximum impact resistance
- » 2884018
XP TURBO/4 '19-21, XP 1000/4 '19-23



LR LOCK RIDE HALF WINDSHIELD - HARD COAT POLY

- Impact-resistant, long-lasting .64 cm durable hard coated polycarbonate
 - Provides protection and airflow into the cab
 - 17.8 cm tall
- » 2884768
TURBO S '18-21, XP TURBO/4 '19-21, TURBO S 4 '19-21, XP 1000/4 '19-23



FULL WINDSHIELD - GLASS

- Double layer laminated, tempered glass windshield
 - Fits seamlessly with the roof and hood of your vehicle to form a complete seal for maximum durability and reduced chatter
- » 2884331
XP TURBO/4 '19-21, XP 1000/4 '19-23

> REAR PANELS & DOORS



LR LOCK RIDE POLY REAR PANEL **TOP SELLER**

- » 2881614
XP TURBO '15-21, XP 4 TURBO '16-21, XP 1000/4 '14-23
Not compatible with Extreme Audio Pods (2883739)



LOWER DOOR INSERTS **TOP SELLER**

- Covers the bottom of the door opening, shutting out water and dust
 - Durable plastic construction with steel frame
- » 2-SEAT • 2879509 **[NOT SHOWN]**
TURBO S '18-21, XP TURBO '15-21, XP 1000 '14-23
- » 4-SEAT • 2879942
TURBO S 4 '19-21, XP 4 TURBO '16-21, XP 4 1000 '14-23



CANVAS UPPER DOORS

- Easy install with stock door panels using pre-designated mounting points
 - 23 OZ mold-resistant, UV-stable and crack-resistant materials for lasting durability and protection from the elements
 - Install with roof, full windshield, rear panel and lower doors to create a full cab enclosure for colder weather and/or increased protection from the elements
 - Not compatible with Poly Sport Roof or Audio Roof options
- » 2-SEAT • 2884333
XP TURBO '19-21, XP 1000 '19-23
- » 4-SEAT • 2884332 **[NOT SHOWN]**
XP 4 TURBO '19-21, XP 4 1000 '19-23

> ROOFS



POLY SPORT ROOF TOP SELLER

- Rigid, injection-molded design to eliminate warping in high-heat conditions
- Integrated mounting locations for lighting
- Rugged, textured polyethylene construction for impact and abrasion resistance
- Not compatible with upper or full doors

COLOR	2-SEAT	4-SEAT <small>NOT SHOWN</small>
■ MATTE BLACK	2883073	2883074
	XP TURBO '15-21, XP 1000 '14-23	XP 4 TURBO '16-21, XP 4 1000 '14-23

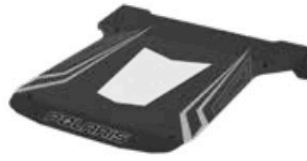

GRAPHIC SPORT ROOF

- Weighs only 5 kg (30% lighter than aluminum)
- Won't bend or break upon impact with debris or other obstacles
- Sunroof lets in sunlight while shading from the heat

COLOR	2-SEAT
■ MATTE BLACK	2881206
■ INDY RED	2881607
	XP TURBO '15-21, XP 1000 '14-23

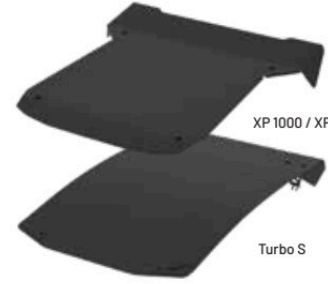

XP 1000 / XP Turbo

Turbo S

ALUMINUM ROOF TOP SELLER

- Seals to the vehicle frame for the best protection and great integration with other RZR accessories
- Strong and durable 5051 aluminum construction for long-lasting, reliable protection

COLOR	2-SEAT	4-SEAT <small>NOT SHOWN</small>
■ MATTE BLACK	2881582-458	2881592-458
■ INDY RED	NA	2881592-293
	XP TURBO '15-21, XP 1000 '14-23	XP 4 TURBO '16-21, XP 4 1000 '14-23
■ MATTE BLACK	2884086-458	2884087-458
	TURBO S '18-21	TURBO S 4 '19-21

COMES STOCK ON TURBO S AND TURBO S 4 DYNAMIX

> VEHICLE PROTECTION

LOW PROFILE BUMPER TOP SELLER

- Perfect for heavy-duty protection, with aggressive style and mounting for lights



FRONT

4.4 cm DIAMETER
STEEL TUBE CONSTRUCTION

REAR

COLOR	FRONT	REAR
■ MATTE BLACK	2884019-458	2884020-458
■ INDY RED	2884019-293	2884020-293

XP TURBO '15-21, XP 4 TURBO '16-21, XP 1000/4 '14-23

■ MATTE BLACK	2883132-458	2883133-458
	TURBO S '18-21, TURBO S 4 '19-21	

LOW PROFILE ROCK SLIDERS

- Plated steel construction, durable powdercoat finish
- Easy installation with expanded anchor mount



2-SEAT

LOW PROFILE:
NO LOSS IN GROUND CLEARANCE

4-SEAT

2-SEAT	4-SEAT
■ 2879498-458	2879940-458
■ 2881587-293	NA

2-SEAT: TURBO S '18-21, XP TURBO '15-21, XP 1000 '14-23
4-SEAT: TURBO S 4 '19-21, XP 4 TURBO '16-21, XP 4 1000 '14-23

EXTREME KICK-OUT ROCK SLIDERS

- Rugged steel protection and race-inspired styling
- Low-profile mounting location preserves ground clearance



2-SEAT

4.4 cm DIAMETER
STEEL TUBE CONSTRUCTION

4-SEAT

2-SEAT	4-SEAT
■ 2879456-458	2882079-458
■ 2881586-293	NA

2-SEAT: TURBO S '18-21, XP TURBO '15-21, XP 1000 '14-23
4-SEAT: TURBO S 4 '19-21, XP 4 TURBO '16-21, XP 4 1000 '14-23



FULL COVERAGE FENDER FLARES

- Keep the mud, dirt and debris from launching off the tires and into your face
- Includes two, front only

» 2881985

TURBO S '18-21, TURBO S 4 '19-21,
XP TURBO '15-21, XP 4 TURBO '16-21,
XP 1000/4 '14-23



MUD FLAPS

- Designed to specifically integrate into front fender flares
- Includes two, front only

» 2879938

TURBO S '18-21, TURBO S 4 '19-21,
XP TURBO '15-21, XP 4 TURBO '16-21,
XP 1000/4 '14-23

XP

AUDIO

WINDSHIELDS
& REAR PANELS

ROOF, DOORS
& HEATER

VEHICLE PROTECTION

LIGHTING

STORAGE

MIRRORS & WINCHES

2016-2023 XP 1000,
XP TURBO & TURBO S

2014-2023 RZR XP 1000, XP TURBO & TURBO S

> WINCHES



FEATURES	PRO PRO HEAVY DUTY SERIES	HD HEAVY DUTY SERIES	
RAPID ROPE RECOVERY	STANDARD	NOT AVAILABLE	
AUTO STOP TECHNOLOGY	STANDARD	OPTION	
WINCH LINE	SYNTHETIC ROPE	STEEL CABLE	
CONTROL	WIRELESS STANDARD, WIRED OPTION	WIRED STANDARD, WIRELESS OPTION	
MODEL	2,041 kg	1,588 kg	ADD REQUIRED CABLES
XP 1000/4 '14-23 XP 4 TURBO '16-21 XP TURBO '15-21	TOP SELLER 2882240	TOP SELLER 2881671	XP 1000/4 '19-23, XP TURBO/4 '19-21 Require Winch Cover Kit 2884118
TURBO S '18-21 TURBO S 4 '19-21	2883828		Included with winch

REPLACEMENT PARTS

SYNTHETIC ROPE
2,041 kg SERIES
» 2879187

STEEL CABLE
1,588 kg SERIES
» 2878890

UPGRADE YOUR CONTROLS

WIRED REMOTE CONTROL

- Must order remote handle and socket together

» REMOTE HANDLE 4013466
Works with 2882240, 2883828

» SOCKET 4014228
Works with 2882240, 2883828

UPGRADE YOUR HD WINCH

WIRELESS REMOTE

- Up to 15 m range with LED indicator
- Direct plug & play operation

» 2879316

AUTO STOP UPGRADE

- Billet aluminum
- Replaces stock fairlead

» 2881693
Synthetic Rope Required

> STORAGE



LR LOCK-RIDE 45 L COOLER BOX

» 2881555
TURBO S '18-21, XP TURBO '15-21, TURBO S 4 '19-21,
XP 4 TURBO '16-21, XP 1000/4 '14-23



LR LOCK-RIDE 65 L CARGO BOX **TOP SELLER**

» 2881193
TURBO S '18-21, XP TURBO '15-21, TURBO S 4 '19-21,
XP 4 TURBO '16-21, XP 1000/4 '14-23



LR LOCK-RIDE D-RINGS

» 2881544



LR LOCK-RIDE EXPANSION ANCHOR

» 2876420



SPARE TIRE CARRIER

» 2883487
TURBO S '18-21, TURBO S 4 '19-21

» 2879464
XP TURBO '15-21, XP 4 TURBO '16-21,
XP 1000/4 '14-23



LOWER DOOR STORAGE BAG

» 2880613
TURBO S '18-21, XP TURBO/4 '16-21, TURBO S 4 '19-21, XP 1000/4 '14-23
Requires Lower Door Inserts (2879509, 2879942)
Only compatible with front doors



BED D-RINGS

» 2877460
TURBO S '18-21, XP TURBO '15-21,
TURBO S 4 '19-21, XP 4 TURBO '16-21,
XP 1000/4 '14-23



BASE UNIT OR ADD SPEAKERS

AUDIO ROOF

- Use as an all-in-one solution or a base unit to build your system
- Four high-efficiency 16.5 cm coaxial speakers for unbeatable sound
- Built in push-button dash radio with Bluetooth and AUX
- Modular design for improved serviceability and access
- Not compatible with RIDE COMMAND

	MODEL: S4	S8
(4) 16.5 cm COAXIAL SPEAKERS	✗	✗
(4) 16.5 cm COMPONENT SPEAKERS, MIDS & TWEETERS		✗
4-CHANNEL, 2-OHM, 300W AMPLIFIER		✗
83.8 cm SINGLE-ROW PRO ARMOR LIGHT BAR		✗
DOME LIGHT		✗

S4 AUDIO ROOF

» 2882064
XP TURBO '15-21, XP 1000 '14-23

S8 AUDIO ROOF

» 2882065
XP TURBO '15-21, XP 1000 '14-23



Sound Bar 8



Sound Bar 4

SOUND BAR

- All-in-one solution for a quick and easy audio upgrade to your machine

NOT COMPATIBLE WITH ADDITIONAL/ EXTERNAL SPEAKERS OR RIDE COMMAND

SOUND BAR 8

- Six mid-range/mid-bass speakers and two dedicated tweeters
 - Fully waterproof with large, easy-to-use external controls
- » 2881465
XP TURBO '15-21, XP 1000/4 '14-23, XP 4 TURBO '16-21
Speaker Bar Harness (2882167) required

SOUND BAR 4

- Two mid-range/mid-bass speakers and two dedicated tweeters
- » 2881230
XP TURBO '15-21, XP 1000/4 '14-23, XP 4 TURBO '16-21
Speaker Bar Harness (2882167) required

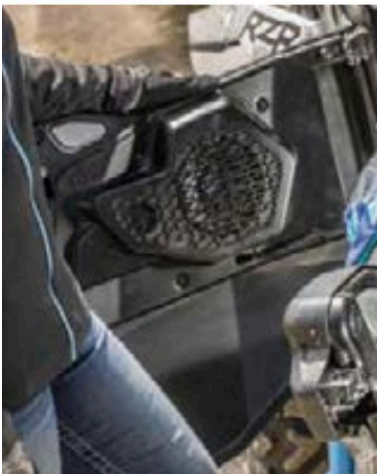

DOOR SPEAKERS TOP SELLER

- 16.5 cm component speakers with 1.9 cm titanium dome tweeters
- Harnessing included to connect to audio amplifier
- Works with Polaris Aluminum Door kits or Polaris Lower Door kits
- Use with RIDE COMMAND requires Audio Amplifier (2884064)

» FRONT • 2881989 (SET OF TWO)

TURBO S '18-21, XP TURBO/4 '15-21, TURBO S 4 '19-21, XP 1000/4 '14-23
Not compatible with DYNAMIX Active Suspension models

» REAR • 2883116 (SET OF TWO)

TURBO S 4 '19-21, XP 4 TURBO '16-21, XP 4 1000 '14-23
Requires Front Door Speakers (2881989).
Connects directly to audio amplifier (2884064).
No additional amplifier needed.
Not compatible with Audio Roofs.

» AUDIO AMPLIFIER • 2884064

TURBO S '19-21, XP TURBO/4 '19-21, TURBO S 4 '20-21, XP 1000/4 '19-23
Required with Door Speakers (2881989, 2883116)

AUDIO Y-HARNESS

- Y-Harness splits the audio signal to allow for additional audio components to be added
- » 2883269
TURBO S '18-21, XP TURBO/4 '19-21, TURBO S 4 '20-21, XP 1000/4 '14-23

LINE-OUT AUDIO HARNESS

- Designed to extend JST audio signal from rear of audio roof to the front of the vehicle
- » 2881652
TURBO S '18-21, XP TURBO/4 '19-21, TURBO S 4 '20-21, XP 1000/4 '14-23

RIDE COMMAND AUDIO ADAPTER

- Required to hook up any audio RIDE COMMAND system
 - Connect up to two speaker options and subwoofer
- » 2883232
TURBO S '18-21, XP TURBO/4 '19-21, TURBO S 4 '20-21, XP 1000/4 '14-23
Required when adding audio to 7" Display (2884072)

RZR TRAIL S

POLARIS
RZR TRAIL



**TRAIL AGILITY.
ENDLESS COMFORT.**



> PERSONALIZED COMFORT

All the essentials to customize your cab for comfortable riding in any element.

WINDSHIELDS P. 69
ROOFS P. 70
DOORS P. 70
HEATER KIT P. 74



> PREMIUM TECHNOLOGY

Take on the trails with unrivaled tech components, ranging from functional to fun.

ROCKFORD FOSGATE AUDIO P. 71
POLARIS PULSE P. 76
LIGHTING P. 76
RIDE COMMAND P. 86



> ULTIMATE DURABILITY

Cover your bases with ease and protection, giving you confidence to stay riding longer.

PROTECTION P. 72
STORAGE P. 73
PRO ARMOR WHEELS & TIRES P. 88

> EXPLORER COLLECTION

Feel confident to take on the trails with all the essentials you need.

2889537 Tip Out Windshield - Hard Coat Poly: P. 69

2884729  Poly Sport Roof: P. 70

2884732-458 Front High Coverage Bumper: P. 72

2884734-458 Rear Bumper Extension***: P. 72

2883763 Premium Convex Rearview Mirror: P. 107

2884524 Adjustable Folding Side Mirrors: P. 107

2884912 Stage 1 PMX Audio Kit by Rockford Fosgate®: P. 71

2883945 Rear Speaker Pods by Rockford Fosgate®: P. 71



- 2415652 Rear Speaker Pod Audio Harness: P. 71
- 2884871 Accent Lights*: P. 84
- 2883123 RIGID SR-Series 25.4 cm Combo LED Light: P. 85
- 2884657 Light Bar Harness: P. 85

- 2884762 Spare Tire Carrier: P. 73
- 2883216 Pro Armor Wheel & Tire Set:
4301 Beadlock & Dual Threat, 26"**: P. 102
- 5416340 Pro Armor Spare Tire: Dual Threat, 26"**: P. 93
- 1523283 Pro Armor Spare Wheel: 4301 Beadlock, 14": P. 101

Shown on Trail.
*Accent lights come stock on Premium/Ultimate models. (U.S. models only)
**May widen vehicle beyond 50".
***U.S. models only



> TRAILBLAZER COLLECTION

Lead the charge with ultimate protection to enjoy the turns of the trails.

- 2884911  Full Vented Windshield - Hard Coat Poly: P. 69
- 2884765  Poly Rear Panel*: P. 69
- 2884761-458 Aluminum Roof: P. 70
- 2884868-458 Front Winch Bumper: P. 72
- 2884734-458 Rear Bumper Extension*: P. 72
- 2879456-458 Extreme Kick-Out Rock Sliders: P. 72
- 2881985 Full Coverage Fender Flares: P. 72

- 2883763 Premium Convex Rearview Mirror: P. 107
- 2884524 Adjustable Folding Side Mirrors: P. 107
- 2881193  65 L Cargo Box : P. 73
- 2885126 Polaris PRO HD 2042 kg Winch with Rapid Rope Recovery: P. 74
- 2883157 Pro Armor Wheel & Tire Set: 5202 & Attack 2.0, 28": P. 102
- 2879332 12MM x 1.5 Splined Lug Nuts with Wrench Adapter: P. 100

> ADVENTURER COLLECTION

All-day riding made easy, with added comfort and maximum visibility.

2884756	Full Vented Windshield - Glass: P. 69
2884755	Windshield Wiper - Washer Kit: P. 69
2884765	LR LOCK RIBBE Poly Rear Panel*: P. 69
2884729	LR LOCK RIBBE Poly Sport Roof: P. 70
2884733	Canvas Upper Doors, 60": P. 70
2884019-293	Front Low Profile Bumper: P. 72
2881587-293	Low Profile Rock Sliders: P. 72
2883763	Premium Convex Rearview Mirror: P. 107
2884735	Heater Kit: P. 74
2884917	Factory Audio Stage 3 Upgrade by Rockford Fosgate*: P. 71

2884648	RIGID® SR-Series 81 cm Combo LED Light Bar: P. 76
2884650	81 cm Light Bar Mount: P. 76
2884657	Light Bar Harness: P. 76
2884183	Polaris PULSE Underhood Bus Bar - 6 Position: P. 76
2881556	LR LOCK RIBBE 48 L Cooler Box*: P. 73
2885126	Polaris PRO HD 2,042 kg Winch with Rapid Rope Recovery: P. 74
2883182	Pro Armor Wheel & Tire Set: 5203 Beadlock & Crawler XG, 28": P. 102
1522240	15" Forged Beadlock Ring: P. 100
2879332	12MM x 1.5 Splined Lug Nuts with Wrench Adapter: P. 100

Shown on Trail S.
*U.S. models only

RZR TRAIL S



> BUILD YOUR CAB

ADD COMFORT AND STYLE WITH END-TO-END PROTECTION



ADD A ROOF

Shield from harsh elements while adding style.

ADD A REAR PANEL

Maintain rear visibility while reducing rear air swirl.

ADD A WINDSHIELD

Protect yourself and your passenger with optical clarity.

ADD DOORS

Keep the cab free of debris and water.

RECOMMENDED BUILD 1

2889537 • Tip Out Windshield - Hard Coat Poly
2884765 • Poly Rear Panel*
2884761-458 • Aluminum Roof

RECOMMENDED BUILD 2

2884756 • Full Vented Windshield - Glass
2884755 • Windshield Wiper - Washer Kit
2884765 • Poly Rear Panel*
2884729 • Poly Sport Roof

*U.S. models only



REVOLUTIONARY INSTALLATION

Lock & Ride clamps make for easy on-off and eliminate the risk of cracking.



GASKETED SEAL

Keeps drafts and moisture out. Reduces ride chatter on full glass windshields.

POLARIS ENGINEERED ADVANTAGES

WINDSHIELDS

GLASS



FULL VENTED WINDSHIELD - GLASS

- Double layer laminated, tempered glass windshield with steel powder-coated frame and center adjustable vent

» 2884756

TRAIL S '21-24, TRAIL '21-24

HARD COAT POLY



FULL VENTED WINDSHIELD - HARD COAT POLY

- Impact-resistant, long-lasting .64 cm durable hard coated polycarbonate
- Full protection with airflow vents that quickly open for cockpit ventilation

» 2884911

TRAIL S '21-24, TRAIL '21-24



TIP OUT WINDSHIELD - HARD COAT POLY

- Hard coated polycarbonate panel windshield that offers three positions: closed, vented and full open
- Single-handed latch with gas support struts

» 2889537

TRAIL S '21-24, TRAIL '21-24



WINDSHIELD WIPER - WASHER KIT

- Simple to control, featuring a multi-speed dash-mounted rocker switch
- Includes a washer fluid reservoir

» 2884755

TRAIL S '21-24, TRAIL '21-24

Compatible with glass windshield only

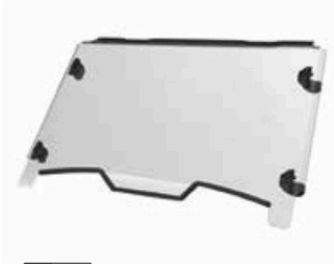

FULL WINDSHIELD - HARD COAT POLY

- Impact-resistant, long-lasting .64 cm durable hard coated polycarbonate
- No frame design offers maximum visibility
- Integrates with all cab components

» 2884757

TRAIL S '21-24, TRAIL '21-24



HALF WINDSHIELD - HARD COAT POLY

TOP SELLER

- Impact-resistant, long-lasting .64 cm durable hard coated polycarbonate
- Provides protection and airflow into the cab
- 17.8 cm tall

» 2884768

TRAIL S '21-24, TRAIL '21-24

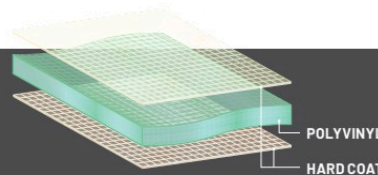
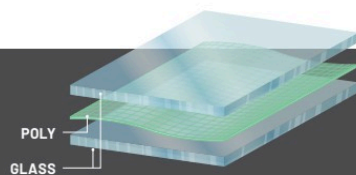

GLASS

VS

HARD COAT POLY

- Superior optical clarity (automotive level)
- Scratch-resistant
- Seals tight
- Cold weather/heavy duty

- Lightweight, flexible, easy to store/remove
- Impact-resistant
- 30x more scratch resistance than regular poly windshields

REAR PANEL



POLY REAR PANEL

- Maintains rear visibility and reduces rear air swirl from entering the cockpit
- Fully compatible with all accessories
- If installed, Rear Audio Pods should project backwards

» 2884765

TRAIL S '21-24, TRAIL '21-24

U.S. MODELS ONLY

RZR TRAIL S



> ROOFS

ALUMINUM VS POLY

High protection strength
Lower profile
Sleek style

Water run-off
Pre-existing mounting features
Lightweight

ALUMINUM

ALUMINUM ROOF TOP SELLER

- Seals to the roll cage for the best protection, while seamlessly integrating with other RZR accessories
- Strong and durable aluminum construction for long-lasting, reliable protection

COLOR	PART NUMBER
MATTE BLACK	2884761-458
INDY RED	2884761-293

TRAIL S '21-24, TRAIL '21-24



POLY



POLY SPORT ROOF

- Rigid, injection-molded design to eliminate warping in high-heat conditions
- Integrated mounting locations for lighting
- Rugged, textured polyethylene construction for impact and abrasion resistance

COLOR	PART NUMBER
MATTE BLACK	2884729

TRAIL S '21-24, TRAIL '21-24
STANDARD ON ULTIMATE TRIM

> DOORS



CANVAS UPPER DOORS

- Pre-loaded tubular aluminum frame provides a tight seal along the roll cage
- Zip-down vinyl windows offer increased comfort in warmer conditions
- Zippered access ports for easy ingress and egress

» 60" • 2884733

TRAIL S '21-24

» 50" • 2884758 [NOT SHOWN]

TRAIL '21-24

ALUMINUM LOWER HALF DOORS

- Single-piece stamped aluminum maximizes quality, fit and finish
- Gasket design eliminates rattling and creates a firm seal

» 2879510

TRAIL S '21-24



Rockford Fosgate

Rockford Fosgate partnered with Polaris to create the next evolution of factory-installed off-road audio. Purpose built to stand up to any outdoor environment and designed to perform no matter the ride. Specifically tuned and rider-centric to create a class-leading audio experience that is second to none.

> AUDIO

TRAIL ACCESSORIES

WINDSHIELDS & REAR PANELS

ROOFS, DOORS & AUDIO

VEHICLE PROTECTION & STORAGE

WINCHES, HEATER & PLOWS

LIGHTING & ELECTRICAL

ACCESSORIZE IT

BUILD YOUR SOUND (CHOOSE THE PATH THAT MATCHES YOUR RZR)

NO FACTORY AUDIO

STEP 1

SELECT HEAD UNIT & ADD AUDIO

7" DISPLAY POWERED BY RIDE COMMAND*

2884072
TRAIL S '22-24

MOUNT KIT REQUIRED
2884731
TRAIL S '22-24

SEE P. 86 FOR FULL RIDE COMMAND DETAILS

OR

STAGE 1 PMX AUDIO KIT

2884912
TRAIL S '21-24, TRAIL '21-24
MOUNT KIT INCLUDED

+

STAGE 3 RIDE COMMAND AUDIO KIT

2884914
TRAIL S '22-24

STEP 2

UPGRADE AUDIO

REAR SPEAKER PODS

2883945
TRAIL S '21-24, TRAIL '21-24

REAR SPEAKER POD AUDIO HARNESS

2415652
TRAIL S '21-24, TRAIL '21-24

REQUIRED TO ADD PODS TO STAGE 1 OR STAGE 3



7" DISPLAY POWERED BY RIDE COMMAND*

» 2884072
TRAIL S '22-24
STANDARD ON ULTIMATE MODELS
Requires Mount Kit (2884731)

SEE P. 86 FOR FULL RIDE COMMAND DETAILS



STAGE 1 PMX AUDIO KIT

- 6.86 cm full color display
- AM/FM/WB tuner w/ antenna*
- Bluetooth connectivity
- Includes mount kit
- Two front 16.5 cm coaxial speakers with enclosures

» 2884912
TRAIL S '21-24, TRAIL '21-24
NOT COMPATIBLE WITH ULTIMATE TRIM



STAGE 3 RIDE COMMAND AUDIO KIT FRONT SPEAKERS & SUBWOOFER

- 200 watt 25.4 cm subwoofer with enclosure
- 400 watt full range amplifier
- Two 50 watt 16.51 cm component speakers with enclosures

» 2884914
TRAIL S '22-24
NOT COMPATIBLE WITH ULTIMATE TRIM or Stage 1 PMX Audio Kit



REAR SPEAKER PODS

USE WITH STAGE 1 OR STAGE 3

- 50 watt 16.51 cm coaxial speakers with can-enclosures, mounting hardware and grilles
- Audio Harness (2415652) required, sold separately

» 2883945
TRAIL S '21-24, TRAIL '21-24

*Due to ongoing supply chain issues, there may be delayed or limited availability of this product as an accessory add-on.

> VEHICLE PROTECTION

BUMPERS & FENDER FLARES



FRONT HIGH COVERAGE BUMPER

- Durable, powder-coated 4.45 cm tube steel with sleek profile for full coverage with headlight protection
- Does not cover Accent Lights

COLOR	PART NUMBER
■ MATTE BLACK	2884732-458
■ INDY RED	2884732-293

TRAIL S '21-24, TRAIL '21-24
Not compatible with Glacier Pro Plow Mount (2884764)



FRONT LOW PROFILE BUMPER

TOP SELLER

- 4.45 cm powder-coated steel tubing provides impact protection and aggressive styling

COLOR	PART NUMBER
■ MATTE BLACK	2884019-458
■ INDY RED	2884019-293

TRAIL S '21-24, TRAIL '21-24



FRONT WINCH BUMPER

- Elevated mounting location on bumper for easy access to 2,041 kg winch
- Requires winch (2885127, 2885126), sold separately

COLOR	PART NUMBER
■ MATTE BLACK	2884868-458

TRAIL S '21-24, TRAIL '21-24



REAR BUMPER EXTENSION

- Bumper extension quickly attaches to rear ROPS to provide additional taillight protection

COLOR	PART NUMBER
■ MATTE BLACK	2884734-458

TRAIL S '21-24, TRAIL '21-24
(U.S. MODELS ONLY)



REAR DELUXE BUMPER

- Rear bumper extension expressly developed for EU-Models

COLOR	PART NUMBER
■ MATTE BLACK	2880164-458

TRAIL S '21-24 EU MODEL



152.4 CM STYLE FENDER FLARES

- Stock replacement for Trail S
- Includes four, front and rear

» 2879434

TRAIL S '21-24, TRAIL '21-24



FULL COVERAGE FENDER FLARES

- Keep the mud, dirt and debris from launching off the tires and into your face
- Includes two, front only

» 2881985

TRAIL S '21-24, TRAIL '21-24

ROCK SLIDERS



10-GAUGE STAMPED STEEL
NO LOSS IN GROUND CLEARANCE

LOW PROFILE

COLOR	PART NUMBER
■ MATTE BLACK	2879498-458
■ INDY RED	2881587-293

TRAIL S '21-24, TRAIL '21-24



4.5 cm STEEL TUBE CONSTRUCTION
EXTENDS FROM MACHINE FOR
MAX PROTECTION THROUGH ROUGH TERRAIN

EXTREME KICK-OUT **TOP SELLER**

COLOR	PART NUMBER
■ MATTE BLACK	2879456-458
■ INDY RED	2881586-293

TRAIL S '21-24, TRAIL '21-24

ANCHOR MOUNTS

Tougher than conventional nuts and bolts, Expansion Anchor Mounts are engineered into every RZR, allowing for a fast install.

BUMPER ANCHOR PACK

- Four anchors and two bumper end caps included

» 2205114



UNEXPANDED

EXPANDED



> STORAGE



48 L COOLER BOX

- One-piece, rotomolded construction for extreme durability
- Lid locks securely in place with rubber latches to protect cargo
- Heavy-duty hinges and weatherproof seal block moisture and dust
- Keeps food and beverages cool for 48+ hours, depending on conditions
- UV-fade resistant
- Installs quickly and easily without tools
- Easy to carry with integrated grab handles

» 2881556

TRAIL S '21-24, TRAIL '21-24
(U.S. MODELS ONLY)



65 L CARGO BOX TOP SELLER

- Integrated rear cargo box, touting 65 L of storage
- Secure latching lid with taut rubber strap tie-downs
- Lightweight design integrates seamlessly into the rear cargo bed
- Includes all mounting hardware for complete installation

» 2881193

TRAIL S '21-24, TRAIL '21-24



SPARE TIRE CARRIER

- Mounts to rear ROPS to keep cargo bed free
- Compatible with Rear Bumper Extension (2884734-458)
- Quick installation

» 2884762

TRAIL S '21-24, TRAIL '21-24
(U.S. MODELS ONLY)

BED D-RINGS

» 2877460

TRAIL S '21-24, TRAIL '21-24



D-RINGS

» 2881544

TRAIL S '21-24, TRAIL '21-24



MIRRORS
SEE P. 107

RZR TRAIL S



> WINCHES



FEATURES	PRO PRO HEAVY DUTY SERIES	HD HEAVY DUTY SERIES	
RAPID ROPE RECOVERY	STANDARD	NOT AVAILABLE	
AUTO STOP TECHNOLOGY	STANDARD	OPTION	
WINCH LINE	SYNTHETIC ROPE	STEEL CABLE	
CONTROL	WIRELESS & WIRED STANDARD	WIRED STANDARD, WIRELESS OPTION	
MODEL	2,041 kg	1,588 kg	ADD REQUIRED CABLES
TRAIL S '21-24 TRAIL '21-24	2885126	2885127	WINCH COVER KIT REQUIRED 2884118 TRAIL S '21-24, TRAIL '21-24

REPLACEMENT PARTS



15 M SYNTHETIC ROPE
2,041 kg SERIES
» 2879187



15 M STEEL CABLE
1,588 kg SERIES
» 2878890

UPGRADE YOUR HD WINCH

WIRELESS REMOTE

- Up to 15 m range with LED indicator
 - Direct plug & play operation
- » 2879316



AUTO STOP UPGRADE

- Billet aluminum
 - Replaces stock fairlead
- » 2881693
Synthetic Rope required

> HEATER



HEATER KIT

- Connects to Polaris PULSE Bus Bar to provide reliable, steady heat to your cab with fan speed and temperature control
- Selectable vent positions include driver/passenger, defrost or a combination of both
- Includes two defrost vents and two cabin vents
- Compatible with subwoofer upgrade

» 2884735
TRAIL S '21-24, TRAIL '21-24



> PLOWS

❄️ GLACIER PRO HD PLOW SYSTEM

MAKE QUICK WORK OF SMALLER JOBS

Move snow with the tough and capable Glacier Pro HD Plow System and discover why a major snowfall can be the highlight of your week. With a robust frame, beefy poly and steel blade options, dismantling and amazing value, Glacier Pro HD is a great choice in the dead of winter.



GLACIER PRO HD GIVES YOU

168 cm
BLADES

CHOICE OF
POLY OR STEEL

MANUAL ANGLE
SYSTEM STANDARD

BUILD A PLOW SYSTEM

	STEP 1 SELECT A MOUNT	STEP 2 SELECT A FRAME	STEP 3 SELECT A LIFT METHOD	STEP 4 SELECT A BLADE	STEP 5 SELECT ACCESSORIES
MODELS	MOUNT	FRAME	WINCH	BLADES	ACCESSORIES
Trail S '21-24 Trail '21-24	Glacier Pro Plow Mount 2884764	Glacier Pro HD Push Frame 2880260	Polaris Pro HD 2,041 kg Winch with Rapid Rope Recovery See P. 74 for details Polaris HD 1,588 kg Winch See P. 74 for details	Glacier Pro Plow Blade 168 cm Poly 2880269 Glacier Pro Plow Blade 168 cm Steel 2880268	168 cm Snow Deflector 2879866 168 cm HD Wear Bar 2879868 168 cm Wear Bar 2879867 Plow Marker 2872726 Skid Shoe 2208864 Shear Pin 2205527 Plow Extension 2880267

BUY A PLOW SYSTEM

GLACIER PRO HD PLOW SYSTEM

- System includes:
- Mount (2884764)
 - Frame (2880260)
 - 168 cm Poly Plow (2880269)
 - Plow Markers (2872726)

» 3880017

TRAIL S '21-24, TRAIL '21-24
Requires winch



> LIGHTING & ELECTRICAL



RIGID SR-SERIES 81 CM COMBO LED LIGHT BAR

- » LIGHT BAR
2884648
TRAIL S '21-24, TRAIL '21-24
- » MOUNT (REQUIRED)
2884650
TRAILS '21-24, TRAIL '21-24
- » HARNESS (REQUIRED)
2884657
TRAIL S '21-24, TRAIL '21-24

ADDITIONAL LIGHTING OPTIONS
SEE P. 84

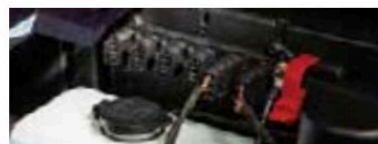

POLARIS PULSE UNDERHOOD BUS BAR - 6 POSITION

- If upgrading to have more than three accessories attaching to the underhood PULSE location, replace the 3 Position Bus Bar with the 6 Position Bus Bar
- » 2884183
TRAIL S '21-24, TRAIL '21-24



PLUG & PLAY ELECTRICAL

POLARIS PULSE IS A REVOLUTIONARY way to provide power to your vehicle, and makes adding electrical accessories a snap.



> TRACKS

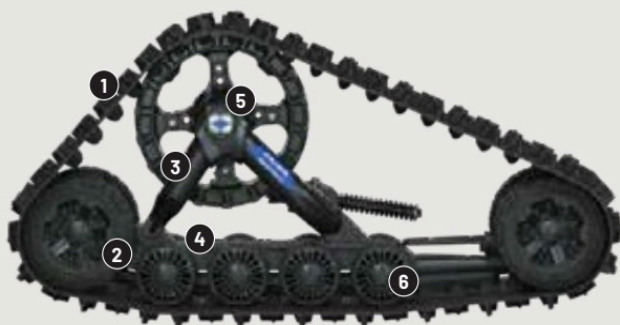

PROSPECTOR PRO 2.0 TRACK SYSTEM

TRACKS

» 2889487

TRAIL S '21-24, TRAIL '21-24

COMPATIBLE WITH

PREMIUM/ULTIMATE ONLY

Plow Extension (2880267) required for using a plow with tracks

Only compatible with Glacier Pro HD System

MOUNTS

» 50" MODELS

2880648

TRAIL '21-24

» 60" MODELS

2880649

TRAIL S '21-24

1 INDUSTRY-FIRST FLEX-TRACK DESIGN

Front-mounted tracks with flexible sides and a slight inward curve allow for stable handling, a more comfortable ride and precise steering over long-distances or extended working hours.

2 HIGH-DENSITY TIRE WITH ADJUSTED SHAPE

With puncture-proof tires that reduce friction and wear, the Prospect Pro 2.0 Tracks deliver trouble-free performance.

Confidently take on bumps and obstacles with 8" high-density tracks.

3 LIGHTWEIGHT POWDER COAT STEEL FRAME

Proven geometry to improve durability and deliver capability in all conditions throughout the life of the tracks.

A lighter frame provides more flotation to stay on top of the snow and allows the tracks to easily shed the elements they encounter.

4 TANDEM STABILIZER

The bolt-on, tandem mid-roller wheel provides a smoother ride by absorbing shocks.

5 BEARING HOUSING

Outer seals and stainless steel sleeves allow stronger bearing durability and greater reliability.

6 WHEEL CAP & SEAL

A fitted wheel cap with bladder effect eliminates water absorption due to temperature variation. Ride in snow or mud without worrying about track maintenance.



**ACCESSORIZE
YOUR RZR
TO MAKE IT YOURS**



TRAIL ACCESSORIES

WINDSHIELDS
& REAR PANELS

ROOFS, DOORS
& AUDIO

VEHICLE PROTECTION
& STORAGE

WINCHES, HEATER
& PLOWS

LIGHTING & ELECTRICAL
& TRACKS

ACCESSORIZE IT

> LIGHTING

RIGID LIGHT BARS P.84

A trusted name in the off-road lighting industry, RIGID delivers unmatched technology and superior performance.



FROM
DUSK

Extend your ride time and be more visible to others with the brightest light bars in the industry.

PRO ARMOR LIGHT BARS P.85

Pro Armor gives you aggressive styling, rugged protection and lighting solutions for your riding needs.

'TIL

DAWN

> BUILD YOUR VISION

OPTICS

USAGE

DRIVING SPEED

LIGHT ANGLE

ACCENT

DIFFUSED COLORED LIGHT ADDED FOR STYLE & PERSONALIZATION

- Durable, dust and water resistant construction
- Ideal for showcasing your lifted vehicle or custom suspension



ALL

DRIVING

GREAT FOR ALL RIDING STYLES, TERRAINS OR WORK APPLICATIONS

- Beam: Extra-wide, moderate center intensity
- Recommended Mounting: All points



SLOW TO MEDIUM

FLOOD

BEST FOR WIDE-OPEN TERRAINS OR WORK APPLICATIONS REQUIRING BROAD LIGHT

- Beam: Wide, shorter
- Recommended Mounting: Low & rear
- Ideal for medium speeds when peripheral vision is important



SLOW TO MEDIUM

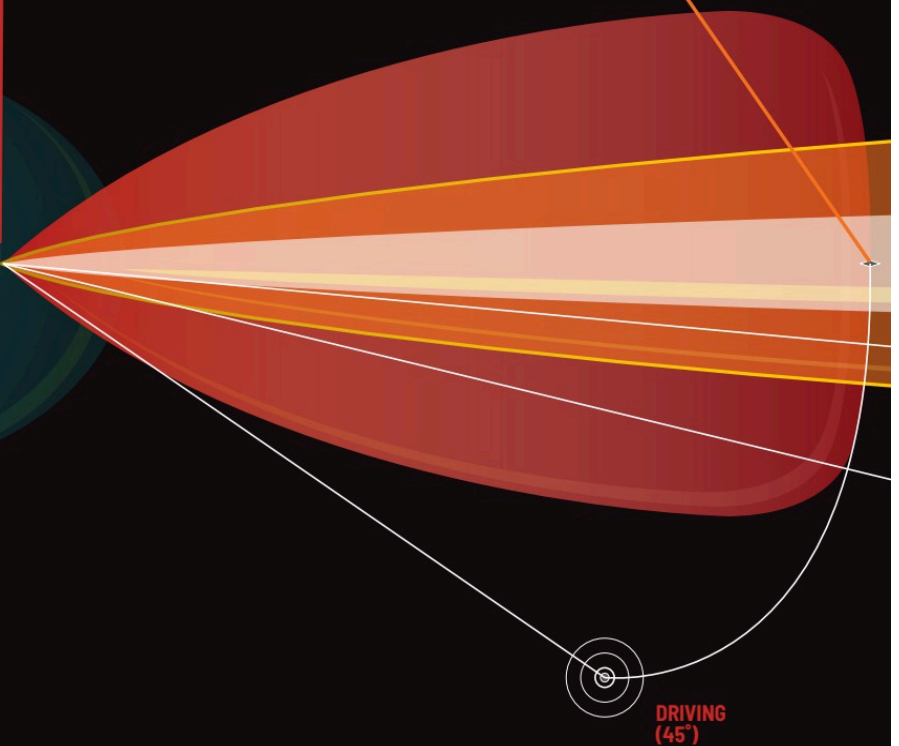
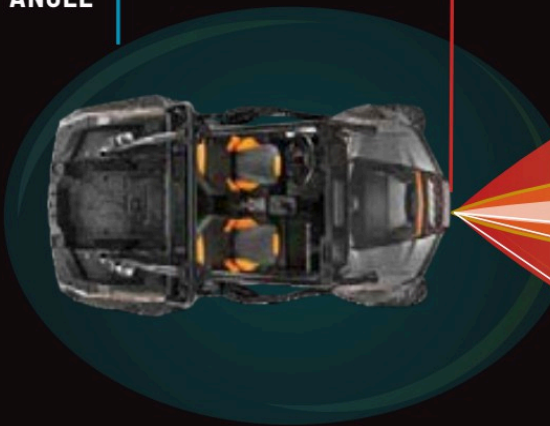

CUSTOMIZE YOUR ILLUMINATION MIX & MATCH LIGHTS

SPOT

**BEST FOR TIGHT RIDING TERRAINS
AND CONDITIONS REQUIRING
LONG-DISTANCE VISIBILITY**

- Beam: Concentrated long beam
- Recommended Mounting: High
- Ideal for high speeds so you can see and react to your environment



HIGH

COMBO

**ALL-AROUND VERSATILITY FOR
ANY RIDING TERRAIN, CONDITION
OR WORK APPLICATION**

- Beam: Combination of flood and spot optics
- Recommended Mounting: All points
- Ideal for all-around distance visibility



ALL

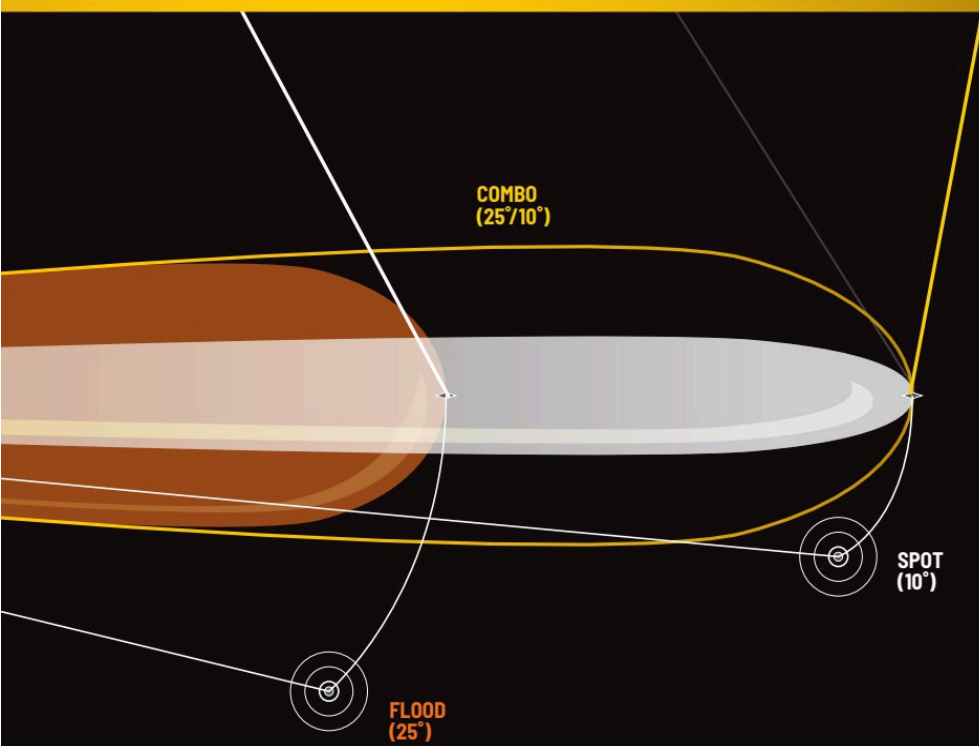

COMMON

LIGHTING

CONNECTED
TECHNOLOGY

WHEELS & TIRES

COOLERS

COCKPIT ACCESSORIES &
MIRRORS

WINCHES

ADDITIONAL
ACCESSORIES & YOUTH



**POLARIS ENGINEERED
ADVANTAGES**

MOUNTS PERFECTLY
Designed for your Polaris Engineered bumper, roof or other mounting point

**ADVANCED
TECH**

RIGID lights are driven by Aluminum PCB Smart Boards, 6063-T5 aircraft aluminum extruded housings and Tiger Drylac UV protection polyester powder-coating.

**EXCLUSIVE
OPTICS**

RIGID invests heavily in optical science and has patented multiple optics and optics systems, maximizing light output and efficiency.

LIGHT BAR TYPES



SR-SERIES PRO

Sleek, powerful, low-profile (under 5 cm tall). Lights extreme distances with low energy usage.

Available in 25.4 cm & 81.3 cm



D-SERIES PRO

Compact to fit almost anywhere with high output and low energy usage.

Available in Driving, Flood & Spot

OPTICS

DRIVING

FLOOD

SPOT

LIGHT BAR OPTIONS

1200 m
960 m
720 m
480 m
240 m

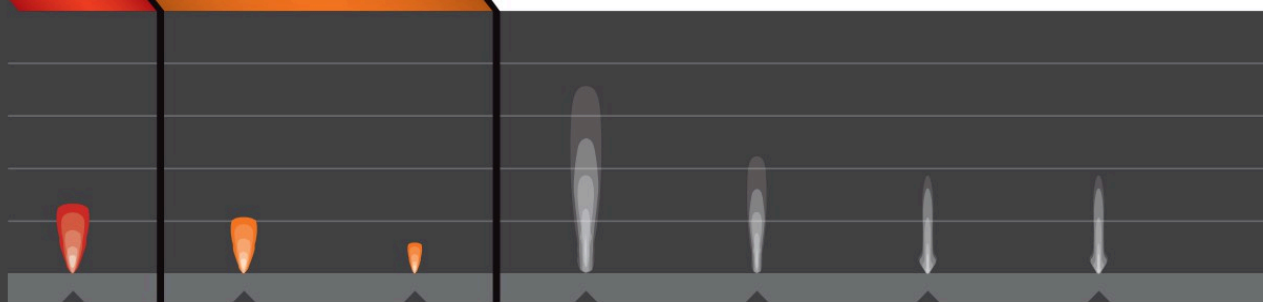

BRAND	RIGID	RIGID	RIGID	RIGID	RIGID	PRO ARMOR	PRO ARMOR
SIZE	POD	25.4 CM	POD	25.4 CM	POD	27.9 CM	27.9 CM
TYPE	D-SERIES	SR-SERIES	D-SERIES	SR-SERIES	D-SERIES	SINGLE-ROW	DUAL-ROW
RAW LUMENS	4,752	7,920	3,168	7,920	3,168	2,450	4,900
PN	2883128	2883122	2883126	2883121	2883127	2889788 2889789	2889786 2889787
	Comes in a pair		Comes in a pair		Comes in a pair		



FRONT



REAR

ACCENT LIGHTS TOP SELLER

- Includes a pair of front fascia accent lights and a rear, center taillight (rear light with kit only)
- Durable dust and waterproof construction

» FRONT/REAR KIT • 2884053

TURBO S/4 '19-21, XP TURBO/4 '19-21, XP 1000/4 '19-23

» FRONT • 2884871

TRAIL S '21-24, TRAIL '21-24, TURBO S/4 '19-21, XP TURBO/4 '19-21, XP 1000/4 '19-23

MAX PERFORMANCE
Validated to work as hard as
your machine does

DOESN'T OVERTAX
Trust it to work when
you need it to



RUGGED CONSTRUCTION

Pro Armor lights are designed to be big and beefy with an aggressive style all their own, and housed in IP67 marine-grade rated UV polyester powder-coating.

MASSIVELY BRIGHT

Pro Armor builds bright lights designed for any riding experience. All that power is directed through heat dissipating aluminum for streamlined heat management.



DUAL-ROW LED

The most spread and farthest illumination downrange. Easy to mount.

Available in 27.9 cm & 78.7 cm



SINGLE-ROW LED

Powerful, compact, low-profile light bars with a sleek look.

Available in 27.9 cm, 50.8 cm & 83.8 cm



CUBE LED

Small size allows mounting in strategic locations for added lighting.

Available in Spot

COMBO

OPTICS

1,200 m
960 m
720 m
480 m
240 m

PRO ARMOR CUBE
DUAL-ROW
1,500
2889794
2889795

RIGID 81.3 CM
SR-SERIES
20,064
2884648

RIGID 25.4 CM
SR-SERIES
7,920
2883123

PRO ARMOR 83.8 CM
SINGLE-ROW
7,500
2889791

PRO ARMOR 78.7 CM
DUAL-ROW
13,500
2889790

PRO ARMOR 50.8 CM
SINGLE-ROW
4,700
2889792

BRAND SIZE
TYPE
RAW LUMENS
PN

ADD A HARNESS TO MOUNT YOUR LIGHTS

MODEL	LIGHT BAR SET-UPS	
	1 LIGHT IN 1 LOCATION ON 1 SWITCH	2 LIGHTS IN 2 LOCATIONS ON 1 SWITCH
TRAIL S '21-24 TRAIL '21-24	LIGHT BAR HARNESS 2884657	LIGHT BAR HARNESS 2884657 ADAPTER HARNESS 2412616 LED Y-HARNESS 2879860
PRO R / 4 '22-24 PRO XP / 4 '20-24 TURBO R / 4 '22-24	LIGHT BAR HARNESS 2883949 ADAPTER HARNESS 2412616	LIGHT BAR HARNESS 2883949 ADAPTER HARNESS 2412616 LED Y-HARNESS 2879860
XP / 4 '24	NEW LIGHT BAR HARNESS 2889291	NEW LIGHT BAR HARNESS 2889291 ADAPTER HARNESS 2412616 LED Y-HARNESS 2879860

LIGHT BAR MOUNT

- Optional cast mount for added style
 - Compatible with all Pro Armor light bars
- » 2890053

ADDITIONAL LIGHT BAR OPTIONS

PRO R, TURBO R & PRO XP | SEE P. 32
XP | SEE P. 52

> CONNECTED TECHNOLOGY

GO REMOTE.
STAY CONNECTED.



POLARIS RIDECOMMAND

PLAN YOUR RIDE

Plan an epic ride with stops along the way, customize and adjust your path to maximize your route. You can even share your planned route with friends.

DISCOVER NEW TRAILS

With over 1,000,000 miles of trails available offline, you'll have the confidence to explore further, whether you have cellular coverage or not.



COMMON

LIGHTING

CONNECTED TECHNOLOGY

WHEELS & TIRES

COOLERS

COCKPIT ACCESSORIES & MIRRORS

WINCHES

ADDITIONAL ACCESSORIES & YOUTH

7" DISPLAY POWERED BY RIDE COMMAND*

Bright, 7" touchscreen visible in all conditions

GPS Navigation & Pre-Loaded Maps

Available offline on the in-dash display so you always know where you are.

Route Planning

Add points of interest and waypoints to make the most of your off-road adventure.

Camera Integration

Navigate with full view of your surroundings. Use the integrated rear camera to see others behind you while riding.

Personalized Audio Experience

Seamlessly pair your display via Bluetooth to wirelessly stream music and stay connected with call and text alerts.

Configurable Gauges

Customize your ride experience with elevation, travel direction, fuel level and more to create relevant screens for you.

» 2884072

PRO R/4 '22-24, XP/4 '24, TURBO R/4 '22-24, PRO XP/4 '22-24, TRAIL S '22-24 TURBO S/4 '19-21, XP TURBO/4 '19-21, XP 1000/4 '19-23 ON XP/4 '24 FOR OFF-ROAD USE ONLY ON TRACTOR AND ZUG VERSION

FRONT CAMERA KIT TOP SELLER

- Front camera upgrade for increased visibility and safety
- Increases driver awareness of obstacles and terrain for enhanced riding
- All wiring harnesses included on vehicle

» 2884432

PRO R/4 '22-24, TURBO R/4 '22-24, PRO XP/4 '20-24, TRAIL S '22-24, TURBO S/4 '19-21, XP TURBO/4 '19-21, XP 1000/4 '19-23

»  2889169

XP/4 '24

7" DISPLAY MOUNT KIT

- Replaces dash for seamless fit and finish
- Includes front and rear cameras with mounts
- Comes with wiring harnesses needed for RZR accessory components
- RIDE COMMAND Audio Adapter (2883232) required when adding audio to an XP

» 2884584

PRO R/4 '22-24, TURBO R/4 '22-24, PRO XP/4 '20-24

» 2884731

TRAIL S '22-24

»  2889289

XP/4 '24

» 2884021

TURBO S/4 '19-21, XP TURBO/4 '19-21, XP 1000/4 '19-23

*Due to ongoing supply chain issues, there may be delayed or limited availability of this product as an accessory add-on.



PRO ARMOR.

TIRES TO TAKE ON ANY ENVIRONMENT

Developed and tested with Polaris engineers, ensuring the perfect fit and optimal performance mile after mile.





COMMON

LIGHTING

CONNECTED TECHNOLOGY

WHEELS & TIRES

COOLERS

COCKPIT ACCESSORIES & MIRRORS

WINCHES

ADDITIONAL ACCESSORIES & YOUTH



For off-road use only. Please check fitment with your dealer.

> WHEELS & TIRES



KNOW YOUR TIRES

DIMENSIONS			USAGE	TREAD DEPTH	TIRE WEIGHT	PLY RATING	SIDEWALL BELTS	LOAD RATING
32" x 9" R15 Part Number			FRONT/ REAR	30 mm	18 kg	10	3	499 kg
TIRE HEIGHT	TIRE WIDTH	WHEEL DIAMETER	Where can you use the tire	Deeper treads have more grip in all conditions	A lighter tire makes for improved vehicle performance	Indicates tire puncture-resistance	Increase your resistance to sidewall punctures	How much weight can the tire handle

WAYS TO SHOP >>>

TIRES BY SIZE



PRO ARMOR

26"	27"	28"	29"	30"	32"	33"
ATTACK	MUD XC	ATTACK 2.0	DUAL-THREAT	ATTACK 2.0	ATTACK 2.0	CRAWLER XG
DUAL-THREAT	TREKKER	CRAWLER XG	HD-K	CRAWLER AT	CRAWLER AT	CRAWLER XR
TREKKER	WHITEOUT	CRAWLER XR	MUD XC	CRAWLER XG	CRAWLER XG	PRO RUNNER
			TREKKER	CRAWLER XP	CRAWLER XP	TREKKER
				CRAWLER XR	CRAWLER XR	
				MUD XC	DUAL-THREAT	
				PRO RUNNER	MUD XT	
				TREKKER	PRO RUNNER	
				SAND 12XT	TREKKER	
				SAND 16XT	SAND 16XT	
				WHITEOUT		

SUPERIOR PERFORMANCE & DURABILITY

LIFELONG PERFORMANCE

- Every tire is designed and constructed with longevity in mind
- 3,000+ mile rated (4,828 kilometers)

PREMIUM PROTECTION

- Pro Armor makes tires with extra protection exactly where it's needed most – the sidewall
- Triple-belted sidewalls keep your tires more resistant so you can keep going

TOUGH TIRES

- Higher ply ratings mean added protection
- Pro Armor builds 8 or 10-ply rated tires for higher puncture-resistance

KNOW YOUR TERRAIN



- Tread patterns optimized for extreme traction
- Ideal for both hard pack & loose trail



- Extra deep treads
- Self-cleaning lugs



- Provides traction & durability
- Performs in hard sand, jagged rocks or any extreme terrain



- Paddles provide traction and durability in soft sand
- Built to float on top of sand



- Flexible "grippy" tread
- Aggressive side bite



- Handles extreme cold
- Holds shape & provides traction

KNOW YOUR WHEELS

STEP 1: SELECT YOUR SERIES

4 = 40-SERIES 5 = 50-SERIES 6 = 60-SERIES

STEP 2: CHOOSE YOUR LOAD RATING

1 = <362.9 KG 2 = 363 - 589.7 KG 3 = 590 - 726+ KG

STEP 3: PICK YOUR STYLE

OFFSET / BEADLOCK / COLOR

INCREASE OFFSET FROM STOCK = NARROWER STANCE
DECREASE OFFSET FROM STOCK = WIDER STANCE

TIRES BY TERRAIN

TRAIL	ROCK	DESERT	MUD	SAND	SNOW
ATTACK	ATTACK 2.0	ATTACK	MUD XC	SAND 12XT	ATTACK
ATTACK 2.0	CRAWLER AT	ATTACK 2.0	MUD XT	SAND 16XT	ATTACK 2.0
CRAWLER AT	CRAWLER XG	CRAWLER AT			HD-K
CRAWLER XG	CRAWLER XP	CRAWLER XG			WHITEOUT
CRAWLER XP	CRAWLER XR	CRAWLER XP			
CRAWLER XR	DUAL-THREAT	CRAWLER XR			
DUAL-THREAT	PRO RUNNER	DUAL-THREAT			
HD-K		PRO RUNNER			
MUD XC					
PRO RUNNER					
TREKKER					

WHEELS BY SIZE

14"	15"	16"
40-SERIES (18 TIRE OPTIONS)	50-SERIES (28 TIRE OPTIONS)	60-SERIES (1 TIRE OPTION)
4201	5101	6301 BEADLOCK
4202	5201	
4203 BEADLOCK	5202	
4204	5203 BEADLOCK	
4205	5204	
4206	5205	
4301 BEADLOCK	5206	
4302 BEADLOCK	5207	
4303	5208	
HD DUAL BEADLOCK	5301 BEADLOCK	
	5302 BEADLOCK	
	5303	
	5304 BEADLOCK	
	5305 BEADLOCK	
	5306	
	5307	
	5307 BEADLOCK	

For off-road use only. Please check fitment with your dealer.

COMMON

LIGHTING

CONNECTED TECHNOLOGY

WHEELS & TIRES

COOLERS

COCKPIT ACCESSORIES & MIRRORS

WINCHES

ADDITIONAL ACCESSORIES & YOUTH

> TIRES



FRONT/REAR

PRO ARMOR ATTACK 2.0

- Engineered for excellent hard-pack performance
- Dual-compound technology and radial construction offer performance in all terrains
- Tight thread pattern for quieter ride

		TREAD DEPTH	TIRE WEIGHT	PLY RATING	SIDEWALL BELTS	LOAD RATING	
15"	28" x 10" R15 5416344	FRONT/ REAR	25mm	10	3	15 kg	
15"	30" x 10" R15 5416345					17 kg	560 kg
15"	32" x 10" R15 5418252					20 kg	630 kg



WHEEL SIZE

15"

ATTACK 2.0

TIGHTER TREAD PATTERN =
Better traction in hard-pack

DUAL-DUROMETER LUG =
Increased grip & traction in rough terrain, smoother ride in all terrain

10-PLY RATED =
Increased durability

LARGER 28" - 32" SIZES =
More ground clearance & trail traction



FRONT/REAR

PRO ARMOR ATTACK

- The best all-purpose tire for all-season traction in any terrain
- Unique, full-face tread design
- Harder durometer lugs promote extended wear, increasing tire life
- Wider spaced lugs provide more grip in softer terrain

		TREAD DEPTH	TIRE WEIGHT	PLY RATING	SIDEWALL BELTS	LOAD RATING
14"	26" x 9" R14 5415613	FRONT	23mm	8	3	13 kg
14"	26" x 11" R14 5415614					REAR



WHEEL SIZE

14"



FRONT/REAR

PRO ARMOR DUAL-THREAT

- Dual-compound technology and radial construction offer performance in all terrains
- Softer durometer rubber on outer edge for overall superior grip and feel
- Harder durometer rubber in the middle for increased traction during acceleration and longer tread life

			TREAD DEPTH	TIRE WEIGHT	PLY RATING	SIDEWALL BELTS	LOAD RATING
14	26" x 9" R14 5416340	FRONT	16mm	12 kg	10	3	413 kg
14	26" x 11" R14 5416341	REAR		14 kg			504 kg
14	29" x 9" R14 5416342	FRONT		14 kg			504 kg
14	29" x 11" R14 5416343	REAR		16 kg			599 kg
15	32" x 10" R15 5416753	FRONT/REAR		17 kg			902 kg



DUAL-COMPOUND = MORE GRIP + LONGER LIFE

Firmer Durometer Rubber = Longer Life

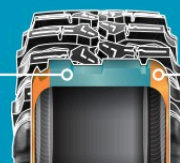

Softer Durometer Rubber = More Grip



FRONT/REAR

PRO ARMOR PRO RUNNER

- Designed to be lightweight, high-performance and quicker in corners/flats
- Triple-belted sidewalls offer extra protection where it's needed the most
- Lug separation provides a great grip and an easy clean in mud and sand

			TREAD DEPTH	TIRE WEIGHT	PLY RATING	SIDEWALL BELTS	LOAD RATING
15	30" x 9" R15 5417531	FRONT/REAR	14mm	13 kg	8	3	531 kg
15	32" x 9.5" R15 5417532			16 kg			630 kg
15	33" x 9.5" R15 5417533			17 kg			671 kg



For off-road use only. Please check fitment with your dealer.

> TIRES



FRONT/REAR

PRO ARMOR CRAWLER XR

- Premium grip for all terrains, from the trail to the rocks
- Square block profile for even surface contact
- A tougher durometer than the XG to take on the toughest a trail has to offer

		TREAD DEPTH	TIRE WEIGHT	PLY RATING	SIDEWALL BELTS	LOAD RATING
14	28" x 10" R14 5415536	FRONT/ REAR 16mm	15 kg	8	3	517 kg
15	30" x 10" R15 5418254		16.8 kg			581 kg
15	32" x 10" R15 5416114		18 kg			630 kg
15	33" x 10" R15 5417174		18 kg			630 kg



WHEEL SIZE



FRONT/REAR

PRO ARMOR CRAWLER AT

- Directional tread for optimal performance
- Greater lug separation for easy mud clean out
- 8-ply, triple-belted ballistic sidewalls resist punctures

		TREAD DEPTH	TIRE WEIGHT	PLY RATING	SIDEWALL BELTS	LOAD RATING
15	30" x 10" R15 5417534	FRONT/ REAR 18mm	16 kg	8	3	580 kg
15	32" x 10" R15 5417535		18 kg			630 kg



WHEEL SIZE



WHAT CRAWLER ARE YOU?



XR

SINGLE DUROMETER

- Smaller lug height and single durometer gives this high-speed tire added rigidity and lateral stability when cornering
- Unique lug design excels in hard-pack, fast terrain



AT

DIRECTIONAL LUG PATTERN

- The same taller lug height as Crawler XG, providing more grip and better traction
- Wider lug spacing for excellent mud clean-out



FRONT/REAR

PRO ARMOR CRAWLER XG

- Built to crawl over all obstacles, both large and small
- A soft, sticky compound makes this tire ideal for both rock crawling and desert running
- 8-ply, triple-belted ballistic sidewalls resist punctures

		TREAD DEPTH	TIRE WEIGHT	PLY RATING	SIDEWALL BELTS	LOAD RATING
14"	30" x 10" R14 5415616	FRONT/ REAR 20mm	17 kg	8	3	581 kg
14"	32" x 10" R14 5416113		19 kg			644 kg
15"	28" x 10" R15 5416346		15 kg			499 kg
15"	30" x 10" R15 5416397		18 kg			581 kg
15"	32" x 10" R15 5416699		19 kg			630 kg
15"	33" x 10" R15 5418255		20 kg			690 kg
16"	32" x 10.5" R16 5416401		20 kg			644 kg



WHEEL SIZE



FRONT/REAR

NEW PRO ARMOR CRAWLER XP

- Ideal for overlanding, rock crawling and desert running with a soft, sticky compound
- Built to maneuver over large and small obstacles
- 8-ply, triple-belted ballistic sidewalls with anti-puncture strength

		TREAD DEPTH	TIRE WEIGHT	PLY RATING	SIDEWALL BELTS	LOAD RATING
15"	30" x 10" R15 5418329	FRONT/ REAR 20mm	17 kg	8	3	580 kg
15"	32" x 10" R15 5418110		19 kg			630 kg



WHEEL SIZE



XG

DUAL-DUROMETER

- Taller lug height and dual-durometer construction
- Perfect balance between high-speed performance, durability and flex in order to grip slick rock



XP

DUAL-DUROMETER

- Channeled outer lugs for superior handling in soft dirt and clay
- Extended side lugs for greater traction on rocks and in sand

For off-road use only. Please check fitment with your dealer.

> TIRES

WHAT PADDLE ARE YOU?



12 PADDLE

- 30" (Non-turbo RZR models)
- Fewer paddles for non-turbo/ lower HP applications
- Perfect grip balance to maintain wheel speed



16 PADDLE

- 30" (Turbo RZR models)
- 32" (Turbo S and Velocity)
- Plenty of aggressive paddles for high HP vehicles
- Superior grip for wide-open sand riding



FRONT

REAR

PRO ARMOR SAND 12XT

- Unique 3-tier concave design on front tires
- Wider rear tires for more traction, plus better grip and flotation on the sand
- 12 paddles for optimized performance on non-turbo models
- 28mm paddle depth specifically designed for increased traction, while limiting sand throw

			TREAD DEPTH	TIRE WEIGHT	PLY RATING	SIDEWALL BELTS	LOAD RATING
14"	30" x 11" R14 5415251	FRONT	12.8mm	10 kg	8	2	388 kg
14"	30" x 13" R14 5416949	REAR	28mm	11 kg	4		476 kg



WHEEL SIZE

14"



FRONT

REAR

PRO ARMOR SAND 16XT

- Unique 3-tier concave design on front tires
- Wider rear tires with additional paddles for more traction, better grip and flotation on the sand
- 16 paddles for optimized performance and traction on turbo models
- 28mm paddle depth specifically designed for increased traction, while limiting sand throw

			TREAD DEPTH	TIRE WEIGHT	PLY RATING	SIDEWALL BELTS	LOAD RATING
15"	30" x 11" R15 5416951	FRONT	13mm	10 kg	4	2	388 kg
15"	30" x 14" R15 5416953	REAR	28mm	15 kg			420 kg
15"	32" x 12" R15 5416952	FRONT	13mm	12 kg			463 kg
15"	32" x 15" R15 5416950	REAR	28mm	16 kg			581 kg



WHEEL SIZE

15"

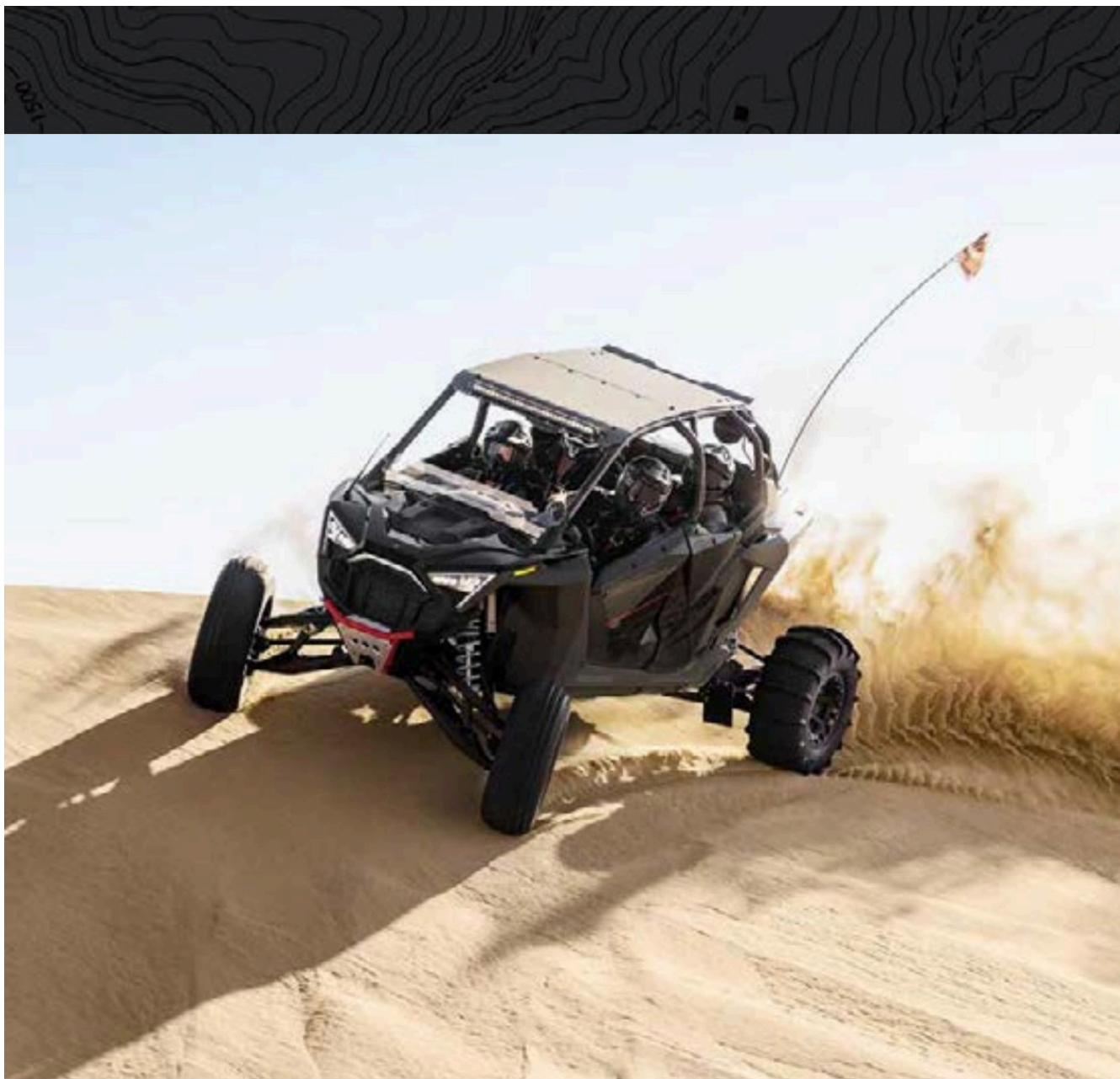

FRONT/REAR

NEW PRO ARMOR TREKKER

- Specialized tread design provides a quiet ride
- Graduated lug depth maximizes the contact patch for ultimate predictability
- 8-ply, triple belted nylon construction

		TREAD DEPTH	TIRE WEIGHT	PLY RATING	SIDEWALL BELTS	LOAD RATING
12"	26" x 10" R12 5418673	FRONT/ REAR 11-17mm graduated	13 kg	8	3	463 kg
14"	27" x 10" R14 5418674		13 kg			490 kg
14"	29" x 10" R14 5418675		15 kg			547 kg
15"	30" x 10" R15 5418676		15 kg			560 kg
15"	32" x 10" R15 5418677		17 kg			631 kg
15"	33" x 10" R15 5418678		18 kg			690 kg



For off-road use only. Please check fitment with your dealer.

> TIRES



FRONT/REAR

PRO ARMOR MUD XC

- Designed as the perfect mud-trail crossover for a smooth ride on the trail and aggressive traction in the mud
- Dual-compound technology with harder durometer lugs promote extended wear, increasing tire life
- 10-ply construction means added protection in the toughest terrain

		TREAD DEPTH	TIRE WEIGHT	PLY RATING	SIDEWALL BELTS	LOAD RATING
14"	27" x 9" R14 5416947	FRONT	14 kg	10	3	531 kg
14"	27" x 11" R14 5416948	REAR	14.5 kg			599 kg
14"	29" x 10" R14 5416946	FRONT/REAR	18 kg			41 kg
15"	30" x 10" R15 5418253	FRONT/REAR	18 kg			581 kg



FRONT/REAR

PRO ARMOR MUD XT

- Aggressive traction in the mud
- Dual-compound technology with harder durometer lugs to promote extended wear and increase tire life
- 10-ply construction for added protection in the toughest terrain

		TREAD DEPTH	TIRE WEIGHT	PLY RATING	SIDEWALL BELTS	LOAD RATING	
15"	32" x 9" R15 5417530	FRONT/REAR	30mm	18 kg	10	3	599 kg



TIRES FOR
ALL TERRAINS



FRONT/REAR

PRO ARMOR HD-K

- Designed to provide a smooth ride and aggressive traction in all riding terrains
- Triple-belted sidewall provides extreme protection and extends the tire life
- Quad belt tread core offers superior protection and longer tread life

			TREAD DEPTH	TIRE WEIGHT	PLY RATING	SIDEWALL BELTS	LOAD RATING
14"	29" x 10" R14 5417507	FRONT/ REAR	31.75mm	18 kg	10	3/1 Aramid	599 kg



FRONT/REAR

PRO ARMOR WHITEOUT

- Extra wide tires for flotation in snow
- Cross-hatched tread pattern designed for superior snow traction with limited digging
- 2-ply sidewall designed to balloon for maximum use of its 15" wide contact patch
- Stud compatible

			TREAD DEPTH	TIRE WEIGHT	PLY RATING	SIDEWALL BELTS	LOAD RATING
14"	27" x 14" R14 5416032	FRONT	16mm	11 kg	8	2	424 kg
15"	30" x 15" R15 5416395	FRONT/ REAR	17mm	21 kg	2		531 kg



MORE SURFACE AREA FOR BETTER FLOTATION ON SNOW

Snow-specific tire for trails and deep powder. Features an extra wide, bias-ply construction that can run at low pressures for maximum flexibility. High-flotation performance maintains critical vehicle ground clearance in the snow.

For off-road use only. Please check fitment with your dealer.

> WHEELS



BEADLOCK INCLUDED

BEADLOCK INCLUDED

BEADLOCK INCLUDED

BEADLOCK REQUIRED

BEADLOCK INCLUDED

BEADLOCK INCLUDED

16" 60-SERIES

15" 50-SERIES

A 6301 BEADLOCK

WEIGHT: 6.1 kg	LOAD RATING: 726 kg	OFFSET: +38
ACCENT:	FRONT/REAR	16" x 7" 1523286
MATTE BLACK:	FRONT/REAR	16" x 7" 1523285

REPLACEMENT CAPS

POLARIS CAPS

HD MATTE BLACK	ALL 4-LUG WHEELS	5457498-458
-----------------------	------------------	-------------

PRO ARMOR CAPS

LUSTER	ALL 4-LUG WHEELS EXCEPT 5203 BEADLOCK, 5204, 5305 BEADLOCK	5453209-410
MATTE BLACK		5453209-458
LUSTER	5203 BEADLOCK	1523015-410
MATTE BLACK		1523015-458
MATTE BLACK	5204	1523063-458
MATTE BLACK	5206, 5207/5303 & 5302 BEADLOCK	5457756-458
MATTE BLACK	5305 BEADLOCK	1525502-458

LUG NUTS

LUG NUTS REQUIRED

12mm x 1.5 SPLINED LUG NUTS

16 LUG NUTS WITH WRENCH	PRO XP/4 '21-24, XP/4 '24, TRAIL/S '21-24, TURBO S '18-21, TURBO S 4 '20-21, XP TURBO/4 '18-21, XP 1000/4 '14-23,	2879332
4 LUG NUTS WITHOUT WRENCH		2879331
SPLINED LUG WRENCH	S 900 '15-20, S 4 1000 '18-20, S 1000 '16-20, 900 '14-20	2204966

BEADLOCK RINGS

BEADLOCK REQUIRED

15" BEADLOCK RINGS

5203 BEADLOCK (Includes Bolts)	
MACHINED:	1522240-266
5301 BEADLOCK REPLACEMENT	
MATTE BLACK:	1523147-458

14" BEADLOCK RINGS

4203 BEADLOCK & HD DUAL BEADLOCK (Includes Bolts)	
MACHINED:	1522244-266
4301 BEADLOCK REPLACEMENT & HD DUAL BEADLOCK	
MATTE BLACK:	1523146-458

A 5101

WEIGHT: 6.6 kg	LOAD RATING: 363 kg	OFFSET: -5
MATTE BLACK:	FRONT/REAR	15" x 10" 1523149-458

B 5201

WEIGHT: 7.8 kg	LOAD RATING: 590 kg	OFFSET: +4
ACCENT:	FRONT/REAR	15" x 7" 1523184-266
MATTE BLACK:	FRONT/REAR	15" x 7" 1523184-458

C 5202

WEIGHT: 8.1 kg	LOAD RATING: 590 kg	OFFSET: +4
ACCENT:	FRONT/REAR	15" x 7" 1523102-266
MATTE BLACK:	FRONT/REAR	15" x 7" 1523102-458

D 5203 BEADLOCK

WEIGHT: 7.3 kg	LOAD RATING: 590 kg	OFFSET: +38
MATTE BLACK:	FRONT/REAR	15" x 7" 1522435-458

E 5204

WEIGHT: 6.1 kg	LOAD RATING: 590 kg	OFFSET: +55
MATTE BLACK:	FRONT/REAR	15" x 7" 1522550-458

F 5205

FRONT WEIGHT: 6.8 kg	LOAD RATING: 408.2 kg	OFFSET: -4
REAR WEIGHT: 9.1 kg	LOAD RATING: 408.2 kg	OFFSET: -38
MATTE BLACK:	FRONT	15" x 8" 1523727-458
	REAR	15" x 10" 1523728-458

G 5206

WEIGHT: 6.1 kg	LOAD RATING: 590 kg	OFFSET: +55
MATTE BLACK:	FRONT/REAR	15" x 7" 1524041

ONLY COMPATIBLE WITH PRO R/4 & TURBO R/4

H 5207/5303

FRONT WEIGHT: 6.1 kg	LOAD RATING: 590 kg	OFFSET: -4
REAR WEIGHT: 6.1 kg	LOAD RATING: 590 kg	OFFSET: -38
MATTE BLACK:	FRONT	15" x 8" 1524043
	REAR	15" x 10" 1524042

ONLY COMPATIBLE WITH PRO R/4 & TURBO R/4

I 5208

WEIGHT: 5.8 kg	LOAD RATING: 544 kg	OFFSET: +55
MATTE BLACK:	FRONT/REAR	15" x 7" 1525454

J 5301 BEADLOCK

WEIGHT: 7.7 kg	LOAD RATING: 726 kg	OFFSET: +38
ACCENT:	FRONT/REAR	15" x 7" 1523282
MATTE BLACK:	FRONT/REAR	15" x 7" 1523286

K 5302 BEADLOCK

WEIGHT: 6.1 kg	LOAD RATING: 590 kg	OFFSET: +55
MATTE BLACK:	FRONT/REAR	15" x 7" 1524038

ONLY COMPATIBLE WITH PRO R/4 & TURBO R/4

L 5304 BEADLOCK

WEIGHT: 7.3 kg	LOAD RATING: 726 kg	OFFSET: +62
MATTE BLACK:	FRONT/REAR	15" x 7" 1525420

ONLY COMPATIBLE WITH PRO R/4 & TURBO R/4

M 5305 BEADLOCK

WEIGHT: 8.4 kg	LOAD RATING: 748 kg	OFFSET: +38
MATTE BLACK:	FRONT/REAR	15" x 7" 1525455

N 5306

WEIGHT: 6.8 kg	LOAD RATING: 789 kg	OFFSET: +62
MATTE BLACK:	FRONT/REAR	15" x 7" 1525684

ONLY COMPATIBLE WITH PRO R/4 & TURBO R/4

O 5307

WEIGHT: 7.3 kg	LOAD RATING: 789 kg	OFFSET: +62
MATTE BLACK:	FRONT/REAR	15" x 7" 1525686

ONLY COMPATIBLE WITH PRO R/4 & TURBO R/4

P 5307 BEADLOCK

WEIGHT: 8.2 kg	LOAD RATING: 789 kg	OFFSET: +62
MATTE BLACK:	FRONT/REAR	15" x 7" 1525688

ONLY COMPATIBLE WITH PRO R/4 & TURBO R/4

Wheels with 5 Lug Nuts. Only compatible with Pro R/4 & Turbo R/4.



14" 40-SERIES

A 4201 ○

FRONT WEIGHT:	5.9 kg	LOAD RATING:	408.2 kg	OFFSET:	+9
REAR WEIGHT:	6.4 kg	LOAD RATING:	590 kg	OFFSET:	+9

ACCENT:	FRONT	14" x 7"	1522956-266
	REAR	14" x 8"	1522957-266
MATTE BLACK:	FRONT	14" x 7"	1522956-458
	REAR	14" x 8"	1522957-458

NOT COMPATIBLE WITH XP 1000/4 '18-24, XP TURBO/4 '18-19

B 4202 ○

FRONT WEIGHT:	5.8 kg	LOAD RATING:	408.2 kg	OFFSET:	+4
REAR WEIGHT:	6.1 kg	LOAD RATING:	590 kg	OFFSET:	-9

ACCENT:	FRONT	14" x 7"	1522544-266
	REAR	14" x 8"	1522545-266
MATTE BLACK:	FRONT	14" x 7"	1522544-458
	REAR	14" x 8"	1522545-458

NOT COMPATIBLE WITH XP 1000/4 '18-24, XP TURBO/4 '18-19

C 4203 BEADLOCK ○ ○

FRONT WEIGHT:	5.9 kg	LOAD RATING:	408.2 kg	OFFSET:	+4
REAR WEIGHT:	6.6 kg	LOAD RATING:	590 kg	OFFSET:	-9

MATTE BLACK:	FRONT	14" x 7"	1522238-458
	REAR	14" x 8"	1522239-458

D 4204 ○

FRONT WEIGHT:	5.9 kg	LOAD RATING:	408.2 kg	OFFSET:	+4
REAR WEIGHT:	6.4 kg	LOAD RATING:	590 kg	OFFSET:	-9

ACCENT:	FRONT	14" x 7"	1522546-266
	REAR	14" x 8"	1522547-266
MATTE BLACK:	FRONT	14" x 7"	1522546-458
	REAR	14" x 8"	1522547-458

E 4205 ○

FRONT WEIGHT:	4.8 kg	LOAD RATING:	408.3 kg	OFFSET:	+4
REAR WEIGHT:	5.7 kg	LOAD RATING:	590 kg	OFFSET:	-9

MATTE BLACK:	FRONT	14" x 7"	1521507-521
	REAR	14" x 8"	1521508-521
LUSTER:	FRONT	14" x 7"	1521507-410
	REAR	14" x 8"	1521508-410

F 4206 ○

FRONT WEIGHT:	4.3 kg	LOAD RATING:	408.2 kg	OFFSET:	+4
REAR WEIGHT:	4.9 kg	LOAD RATING:	590 kg	OFFSET:	-9

MATTE BLACK:	FRONT	14" x 6"	1522542-458
	REAR	14" x 8"	1522543-458

G 4301 BEADLOCK

WEIGHT:	7.3 kg	LOAD RATING:	726 kg	OFFSET:	+38
---------	--------	--------------	--------	---------	-----

ACCENT:	FRONT/REAR	14" x 7"	1523284
MATTE BLACK:	FRONT/REAR	14" x 7"	1523283

NOT COMPATIBLE WITH XP 1000/4 '18-24, XP TURBO/4 '18-19

H 4302 BEADLOCK

WEIGHT:	18.1 kg	LOAD RATING:	725.7 kg	OFFSET:	+58
---------	---------	--------------	----------	---------	-----

MATTE BLACK:	FRONT/REAR	14" x 7"	5418036
--------------	------------	----------	---------

I 4303

WEIGHT:	18.1 kg	LOAD RATING:	725.7 kg	OFFSET:	+58
---------	---------	--------------	----------	---------	-----

MATTE BLACK:	FRONT/REAR	14" x 7"	5418037
--------------	------------	----------	---------

J HD DUAL BEADLOCK

WEIGHT:	18.1 kg	LOAD RATING:	725.7 kg	OFFSET:	+28
---------	---------	--------------	----------	---------	-----

MATTE BLACK:	FRONT/REAR	14" x 7"	1524022-458
--------------	------------	----------	-------------

KNOW YOUR WHEELS

STEP 1: SELECT SERIES

4 = 40-SERIES 5 = 50-SERIES 6 = 60-SERIES

STEP 2: CHOOSE LOAD RATING

1 = <362.9 KG 2 = 363 - 589.7 KG 3 = 590 - 726+ KG

STEP 3: PICK STYLE

OFFSET / BEADLOCK / COLOR

INCREASE OFFSET FROM STOCK = NARROWER STANCE

DECREASE OFFSET FROM STOCK = WIDER STANCE



For off-road use only. Please check fitment with your dealer.

KNOW YOUR TERRAIN



- Tread patterns optimized for extreme traction
- Ideal for both hard-pack and loose trail



- Flexible "grippy" tread
- Aggressive side bite



- Provides traction and durability
- Built to perform in hard sand, jagged rocks or any other extreme terrain

> WHEEL & TIRE SETS

2 WAYS TO PURCHASE

INDIVIDUAL WHEELS & TIRES
- OR -
COMPLETE SETS AS LISTED

Exclusively at Polaris Authorized Dealers



40-SERIES

BACKCOUNTRY/TRAIL

	ATTACK 26"	DUAL-THREAT 26" 29"		NEW TREKKER 27" 29"	
4201 Accent	2882390	2883138	2883146		
4201 Matte Black	2882391	2883139	2883147		
4202 Accent	2881335	2883140	2883148	2890907	2890906
4202 Matte Black	2881336	2883141	2883149	2890905	2890904
4203 BEADLOCK Matte Black BEADLOCKS SOLD SEPARATELY	2881381				
4204 Accent	2881347	2883142	2883150		
4204 Matte Black	2881348	2883143	2883151		
4205 Luster	2881359				
4205 Matte Black	2881360	2883144	2883152		
4206 Matte Black	2881404	2883145	2883153		
4301 BEADLOCK Accent BEADLOCKS PRE-MOUNTED		2883217	2883219		
4301 BEADLOCK Matte Black BEADLOCKS PRE-MOUNTED		2883216	2883218		
4302 BEADLOCK Matte Black BEADLOCKS PRE-MOUNTED	2889549	2889550	2889551	2890909	2890908
4303 Matte Black	2889541	2889542	2889543	2890911	2890910



50-SERIES

BACKCOUNTRY/TRAIL

	28"	ATTACK 2.0 30"	32"	DUAL-THREAT 32"	30"	NEW TREKKER 32"	33"	MUD MUD XC 30"	MUD XT 32"	DESERT/ROCK CRAWLER AT 30" 32"	
5201 Accent	2883160	2883169	2890201	2883694				2890209		2889510	2889518
5201 Matte Black	2883159	2883168	2890202	2883693				2890210		2889511	2889519
5202 Accent	2883158	2883167	2890203	2883696				2890211	2885052	2889512	2889520
5202 Matte Black	2883157	2883166	2890204	2883695	2890916			2890212	2885053	2889513	2889521
5203 BEADLOCK Matte Black BEADLOCKS SOLD SEPARATELY	2883154	2883163	2890205	2883699				2890213	2885056	2889516	2889524
5204 Matte Black	2883155	2883164	2890206	2883700				2890214	2885058	2889517	2889525
5206 Matte Black				2885015		2890925	2890930	2890842	2885019		
5208 Matte Black		2890179	2890180	2890181	2890915			2890182		2890174	2890175
5301 BEADLOCK Accent BEADLOCKS PRE-MOUNTED	2883162	2883171	2890207	2883698	2890914			2890215	2885054	2889514	2889522
5301 BEADLOCK Matte Black BEADLOCKS PRE-MOUNTED	2883161	2883170	2890208	2883697	2890913			2890216	2885055	2889515	2889523
5302 BEADLOCK Matte Black				2885009		2890926	2890931	2890841	2885013		
NEW 5304 BEADLOCK Matte Black BEADLOCKS PRE-MOUNTED			2890675					2890674			2890000
5305 BEADLOCK Matte Black					2890912						
NEW 5306 Matte Black		2890933	2890934			2890922	2890927				2890942
NEW 5307 Matte Black		2890952	2890953			2890923	2890928				2890961
NEW 5307 BEADLOCK Matte Black		2890971	2890972			2890924	2890929				2890980



60-SERIES

ROCK/RACE

CRAWLER XG 32"

6301 BEADLOCK Accent BEADLOCKS PRE-MOUNTED	2883703
6301 BEADLOCK Matte Black BEADLOCKS PRE-MOUNTED	2883702



- Extra deep treads
- Self-cleaning lugs



- Paddles provide traction and durability in soft sand
- Built to float on top of sand



- Triple-belted sidewalls to resist puncture
- Purpose-built, long lasting tread patterns



- Handles extreme cold
- Holds shape and provides traction

COMMON

LIGHTING

CONNECTED TECHNOLOGY

WHEELS & TIRES

COOLERS

COCKPIT ACCESSORIES & MIRRORS

WINCHES

ADDITIONAL ACCESSORIES & YOUTH

MUD

DESERT/ROCK

SAND

MUD XC		CRAWLER XG		CRAWLER XR		SAND 12XT
27"	29"	30"	32"	28"	30"	
2884272	2884265	2882396	2882452	2882394		
2884273	2884266	2882397	2882451	2882395		
2884267	2884260	2881560	2882448	2881343		
2884268	2884261	2881561	2882447	2881344		
			2881382	2881386		
2884270	2884263	2881558	2882450	2881355		
2884271	2884264	2881559	2882449	2881356		2884034
		2881564		2881371		
2884269	2884262	2881563	2882453	2881372		
		2883211	2883215	2883213		
		2883210	2883214	2883212		
2889552	2889553	2889555	2889556	2889554		
2889544	2889545	2889547	2889548	2889546		

28"	CRAWLER XG		33"	NEW CRAWLER XP		CRAWLER XR			PRO RUNNER			
	30"	32"		30"	32"	30"	32"	33"	30"	32"	33"	
2883188	2883179	2889986	2890191	2889950	2889958	2890183	2883194	2884744				
2883187	2883178	2889987	2890192	2889951	2889959	2890184	2883193	2884736				
2883186	2883177	2889988	2890193	2889952	2889960	2890185	2883192	2884737	2885024	2885031	2885038	
2883185	2883176	2889989	2890194	2889953	2889961	2890186	2883191	2884738	2885025	2885032	2885039	
2883182	2883173	2889992	2890195	2889956	2889964	2890187	2882444	2884741	2885028	2885035	2885042	
2883183	2883174	2889993	2890196	2889957	2889965	2890188	2882445	2884743	2885030	2885037	2885044	
		2890026	2890199		2889949	2890847	2885016	2885014	2890845	2885017	2885018	
		2890166	2890167	2890168	2890169	2890170	2890171	2890172	2890173	2890176	2890177	2890178
2883190	2883181	2889991	2890197	2889954	2889962	2890189	2883196	2884739	2885026	2885033	2885040	
2883189	2883180	2889990	2890198	2889955	2889963	2890190	2883195	2884740	2885027	2885034	2885041	
		2890025	2890200		2889948	2890846	2885010	2885008	2890844	2885011	2885012	
		2890027			2890672	2889997	2890673	2889998		2890843		
					2890152	2890153						
		2890939	2890940		2890947		2890944	2890945		2890936	2890937	
		2890958	2890959		2890966		2890963	2890964		2890955	2890956	
		2890977	2890978		2890985		2890982	2890983		2890974	2890975	



SAND

5205	SAND 16XT	
	30"	32"
Matte Black	2884035	2884036
5207/5303		2885020
Matte Black		



SNOW

5101	WHITEOUT
	30"
Matte Black	2883172

⚙️ Lug Nuts required. See previous page for Caps, Beadlock Rings and Lug Nuts.

⚙️ Wheels with 5 Lug Nuts. Only compatible with Pro R/4 & Turbo R/4.

VALVES



COLBY SHORT ULTIMATE VALVE (2 PACK)

» 2883292



COLBY EMERGENCY VALVE (2 PACK)

» 2883293



ORDERABLE THROUGH LOCAL DEALER ONLY

COLBY COMBO VALVE KIT (16 PACK)

• Includes 8 ultimate and 8 emergency valves
» 2883294

PRO XP '21-24, XP/4 '24, TURBO S '18-21, XP TURBO/4 '19-21, TURBO S 4 '20-21, XP 1000/4 '14-23, S 900 '15-20, S 4 1000 '19-20, S 1000 '16-20, 900 '14-20

> COOLERS



MADE FOR RIDERS.
BUILT FOR LIFE.

28, 57 & 99
LITER FEATURES



ComfortCarry
Handles



TravelLock
System



EasyOut
Drain System



NoSlip
Rubber Feet



PolarWall
Insulation



IceLock
Seal



99 LITER

■ **N-V** ■ SAGEBRUSH GREEN • 2890707
GRAPHITE • 2883426

ACCESSORIES

WIRE BASKET • 2883648
DIVIDER (1) • 2883468
WHEELS • 2883967

Divider



1 way to
partition



57 LITER

■ **N-V** ■ SAGEBRUSH GREEN • 2890706
GRAPHITE • 2883425

ACCESSORIES

WIRE BASKET • 2882185
DIVIDERS (2) • 2882184
SEAT CUSHION • 2882179
WHEELS • 2882180

Dividers



2 ways to
partition



28 LITER

■ **N-V** ■ SAGEBRUSH GREEN • 2890705
GRAPHITE • 2883424

ACCESSORIES

WIRE BASKET • 2882438
DIVIDER (1) • 2882186

Divider



1 way to
partition

ESSENTIAL ACCESSORIES SO YOUR COOLER WORKS AS HARD AS YOU DO

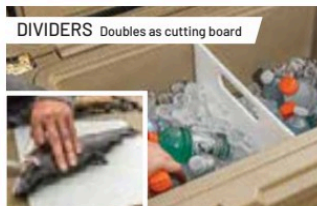

POLARIS
NORTHSTAR
COOLER



POLARIS NORTHSTAR COOLERS CAN SURVIVE JUST ABOUT ANYTHING - FROM EXTREME HEAT TO A NASTY TUMBLE OFF A VEHICLE.



14 LITER

NEW SAGEBRUSH GREEN • 2890704
GRAPHITE • 2883968



19 LITER
SOFT-SIDED COOLER

GRAPHITE • 2889285



HOLDS ICE
FOR AGES

BECAUSE JUST ANY COOLER
WON'T CUT IT OUT THERE.

You need something rugged and reliable. A cooler purpose built to handle the challenges of the off-road—while keeping your provisions on ice for days on end. Because out here, there are no ice machines, and you just left the last one in your dust. So, load it up. Lock it in. And know your NorthStar cooler is staying put—giving you a few extra days of ice time to enjoy the wild.

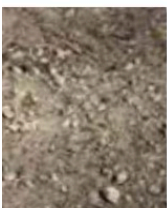

TUMBLER



591 ML • 2883393
NOT AVAILABLE IN EUROPE



28 L COOLER BRACKET

2884070 2889200 2884526
TURBO R/4 '22-24 PRO R/4 '22-24 XP/4 '24
PRO XP/4 '20-24

COMMON

LIGHTING

CONNECTED
TECHNOLOGY

WHEELS & TIRES

COOLERS

COCKPIT ACCESSORIES &
MIRRORS

WINCHES

ADDITIONAL
ACCESSORIES & YOUTH

» COCKPIT ACCESSORIES



HARNESSES

NOT AVAILABLE IN EUROPE

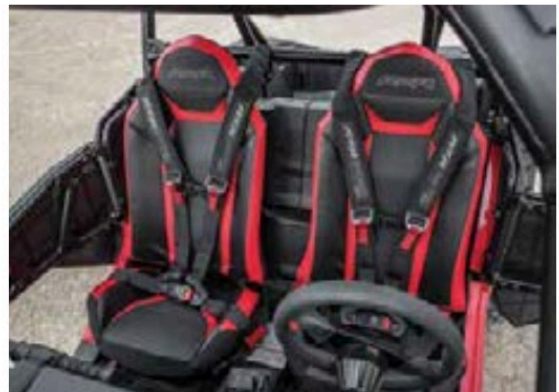

CLICK6 HARNESS TOP SELLER

- Racing-quality, premium construction for increased security
- Six straps hold a driver securely in place in all riding conditions
- One-click, quick-release buckle releases straps, allowing easy egress
- Fully adjustable to fit riders of all sizes
- Easy to buckle and adjust, even while wearing helmet and gloves

2-SEAT

» 2890046

XP '24

» 2890267

PRO R '22-24, TURBO R '22-24,
PRO XP '20-24

4-SEAT FRONT

» 2890048

XP 4 '24

» 2890268

PRO R 4 '22-24, TURBO R 4 '22-24,
PRO XP 4 '20-24

4-SEAT REAR

» 2890049

XP 4 '24

» 2890269

PRO R 4 '22-24, TURBO R 4 '22-24,
PRO XP 4 '20-24

DRIVER SIDE

» 2890263

TRAIL S '21-24, TRAIL '21-24,
TURBO S '18-21, XP TURBO '19-21,
TURBO S 4 '20-21, XP 1000 '14-23,
S 900 '15-20, S 1000 '16-20,
900 '14-20

DOES NOT FIT 4-SEAT MODELS
(EXCEPT FOR TURBO S 4) OR
HIGHLIFTER MODEL

PASSENGER SIDE

» 2890264

TRAIL S '21-24, TRAIL '21-24,
TURBO S '18-21, XP TURBO '19-21,
TURBO S 4 '20-21, XP 1000 '14-23,
S 900 '15-20, S 1000 '16-20,
900 '14-20

DOES NOT FIT 4-SEAT MODELS
(EXCEPT FOR TURBO S 4) OR
HIGHLIFTER MODEL

RZR SUB ZERO 4-PT HARNESS TOP SELLER

DRIVER SIDE

» 2890265

TRAIL S '21-24, TRAIL '21-24,
TURBO S '18-21, XP TURBO/4 '15-21,
XP 1000/4 '14-23, TURBO S 4 '19-21,
S 900 '15-20, S 4 1000 '19-20, S 1000 '16-20,
900 '14-20, PRO XP/4 '20-24

PASSENGER SIDE

» 2890266

TRAIL S '21-24, TRAIL '21-24,
TURBO S '18-21, XP TURBO/4 '15-21,
XP 1000/4 '14-23, TURBO S 4 '19-21,
S 900 '15-20, S 4 1000 '19-20, S 1000 '16-20,
900 '14-20, PRO XP/4 '20-24

2-SEAT

» 2890047

XP '24

4-SEAT

» FRONT • 2890050

XP 4 '24

» REAR • 2890051

XP 4 '24

MIRRORS



ADJUSTABLE FOLDING SIDE MIRRORS

- Left and right mirrors included
- Installs in minutes and integrates into a designed mounting position
- Laminated safety glass for excellent scratch resistance

» 2884524

XP/4 '24, TRAIL S '21-24, TRAIL '21-24, TURBO S '18-21, XP TURBO/4 '19-21, XP 1000/4 '14-23, TURBO S 4 '20-21, S 900 '15-20, S 4 1000 '19-20, S 1000 '16-20, 900 '14-20

Not compatible with Canvas Doors.



PREMIUM CONVEX REARVIEW MIRROR TOP SELLER

- Installs in minutes and integrates into a designated mounting position
- Laminated safety glass for excellent scratch resistance

» 2883763

PRO R/4 '22-24, XP/4 '24, TURBO R/4 '22-24, TRAIL S '21-24, TRAIL '21-24, PRO XP/4 '20-24



CONVEX DESIGN DELIVERS
WIDE REAR VIEW

REARVIEW MIRROR TOP SELLER

- Works with all roofs, soft tops and windshields

» 2877945

TURBO S '18-21, XP TURBO/4 '15-21, XP 1000/4 '14-23, TURBO S 4 '19-21, S 900 '15-20, S 4 1000 '19-20, S 1000 '16-20, 900 '14-20



SCRATCH-RESISTANT GLASS
MIRROR LENS

CONVEX REARVIEW MIRROR TOP SELLER

- Bolts into your choice of pre-designated mounting locations on the vehicle frame for easy install
- Convex design provides broad, expanded view of what's behind or alongside the vehicle

» 2881540

TURBO S '18-21, XP TURBO/4 '15-21, XP 1000/4 '14-23, TURBO S 4 '19-21, S 900 '15-20, S 4 1000 '19-20, S 1000 '16-20, 900 '14-20

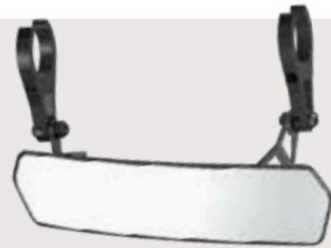

QUICK GLANCE,
WIDE-ANGLE VIEWING FOR
MAXIMUM VISIBILITY

WIDE-ANGLE REARVIEW MIRROR

- Stamped steel frame and backing plate with large 6.4 cm x 35.6 cm convex mirror
- Up to 10° of range to adjust for rider height or view preference
- Easy over-structure installation with stamped steel mounts

» 2881199

TURBO S '18-21, XP TURBO/4 '15-21, XP 1000/4 '14-23, TURBO S 4 '19-21, S 900 '15-20, S 4 1000 '19-20, S 1000 '16-20, 900 '14-20

MISC



SWITCH PANEL

- Adds five spaces for rocker switches without blocking storage

» 2881987

TURBO S '18-21, XP TURBO/4 '15-21, XP 1000/4 '14-23, TURBO S 4 '19-21, S 900 '15-20, S 4 1000 '19-20, S 1000 '16-20, 900 '14-20



> WINCHES

DEPENDABLE. TOUGH. BUILT FOR THE OFF-ROAD.

A Polaris Engineered winch is designed to help you get the job done right, get you on your way faster and prepare you for the unexpected.

WHY POLARIS?

Polaris off road vehicles are engineered with designated mounting points and wiring for seamless install of Polaris Engineered winches.



TESTED 1,200+ PULLS AT MAX LOAD



BUILT TO WITHSTAND -29° C TEMPERATURES



OPERATES FULLY SUBMERGED



MILITARY TESTED & APPROVED

FEATURES & BENEFITS

ALL POLARIS ENGINEERED WINCHES COME WITH:

- ✓ INTEGRATED WIRING, MOUNT, PREASSEMBLED
- ✓ HOOK WITH STRAP
- ✓ CUT STEEL GEARS & SEALED DRIVETRAIN
- ✓ SEALED PERMANENT MAGNET MOTOR



Retrieve cable 5x as fast as standard mode on other Polaris winches. Get back to riding or complete your task quicker.

1. Set winch dial to N (Neutral) to manually pull the rope out and secure the hook to your anchor point
2. Set winch dial to L (Low) for maximum pulling power while winching your load
3. Set winch dial to H (High) for retrieving the rope 5x faster with Rapid Rope Recovery



Auto Stop technology protects and extends the life of your winch by automatically stopping the winch at the end of pull to prevent over-spooling. While plowing, it prevents the plow frame from bending by stopping the winch once the plow has been lifted.



With its lightweight, yet extremely strong, design and superior flexibility, this 15 m long synthetic rope is easy to handle and can stand up to any tough job.



This convenient remote operates your Polaris winch wirelessly from within 15 m of the vehicle. Operate your winch safely outside your vehicle while on the job site or trails.

UPGRADE YOUR CONTROLS

WIRED REMOTE CONTROL



» WIRED REMOTE CONTROL
2889562

Works with 2884835, 2884836

» REMOTE HANDLE
4013466

Works with 2882240
Socket required, sold separately

» SOCKET
4014228

Works with 2882240
Remote handle required, sold separately

REPLACEMENT PARTS

15 M STEEL CABLE

1,588 kg SERIES

» 2878890

15 M SYNTHETIC ROPE

1,588 kg SERIES

» 2878888

2,041 kg SERIES

» 2879187

MODEL

PRO R / 4 '22-24
TURBO R / 4 '22-24

Includes both wired and wireless remote

XP / 4 '24

Includes wireless remote. Wired remote sold separately

TRAIL S '21-24
TRAIL '21-24

PRO XP / 4 '20-24

Includes both wired and wireless remote

PRO PRO HEAVY DUTY SERIES

TOP-OF-THE-LINE FEATURES

BEST FOR PLOWING, HEAVY-DUTY OUTDOOR CHORES & TRAIL RIDING



HD HEAVY DUTY SERIES

BUILT FOR THE OFF-ROAD

BEST FOR THE CASUAL OFF-ROAD RIDER



PRO PRO HEAVY DUTY SERIES

HD HEAVY DUTY SERIES



NOT AVAILABLE



ADD AUTO STOP UPGRADE

2881693

Synthetic Rope required



ADD SYNTHETIC ROPE

2878888



ADD WIRELESS REMOTE

2879316

	2,721 kg	2,041 kg	2,041 kg	1,588 kg
	2884341	2884340		
		NEW 2884836	NEW 2884835	
		2885126 Requires Winch Cover Kit 2884118		2885127 Requires Winch Cover Kit 2884118
	2883759	2883758		

COMMON

LIGHTING

CONNECTED TECHNOLOGY

WHEELS & TIRES

COOLERS

COCKPIT ACCESSORIES & MIRRORS

WINCHES

ADDITIONAL ACCESSORIES & YOUTH

> ADDITIONAL ACCESSORIES

RIDE & REPAIR ESSENTIALS KIT

» 2881207
ALL MODELS



LOCK RIDE RZR WHIP FLAG & POLE

» FLAG & POLE • 2881468
» MOUNT • 2877502
ALL MODELS



PREMIUM FILTER KIT TOP SELLER

- Polaris Ultraweb high performance air filter
- Provides superior engine protection with 99.99% efficiency
- Superior dust-holding capacity
- Lower restriction offers better performance for high horsepower, torque and acceleration



» 2882233

S 900 '15-20, S 4 1000 '19-20,
S 1000 '16-20, 900 '14-20

» 2882234

XP / 4 '24, TURBO S '18-21,
XP TURBO / 4 '19-21, TURBO S 4 '20-21,
XP 1000 / 4 '14-23, PRO XP '21-24

FIRE EXTINGUISHER MOUNT

» 2881200
ALL MODELS



> YOUTH 200 EFI



LOCK RIDE FULL WINDSHIELD

- Made of durable polycarbonate to protect the cab from debris, dust, rain and wind
- Lock & Ride offers easy, toolless installation
- Integrates with the roof to prevent rain from entering the cab

» 2884570
200 EFI '22-24

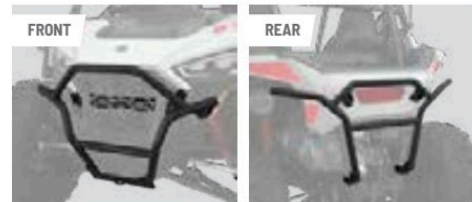

BUMPERS

- Made of durable steel to provide great protection
- Chassis integrated mounting
- Front bumper offers integrated tow hook

» FRONT • 2884577

200 EFI '22-24

» REAR • 2885144

200 EFI '22-24



PRO ARMOR YOUTH SAND 8XT TIRE

- 8 paddles for optimized performance
- Wider rear tires for better traction, grip and flotation on the sand

» FRONT • 24" x 8" R12 • 5418458

» REAR • 24" x 10" R12 • 5418459

200 EFI '22-24

	TREAD DEPTH	TIRE WEIGHT	PLY RATING	SIDEWALL BELTS	LOAD RATING
FRONT	8mm	7.5 kgs	4	2	206 kgs
REAR	16mm	8.2 kgs	4	2	256 kgs



COMMON

LIGHTING

CONNECTED TECHNOLOGY

WHEELS & TIRES

COOLERS

COCKPIT ACCESSORIES & MIRRORS

WINCHES

ADDITIONAL ACCESSORIES & YOUTH



HALF WINDSHIELD

- Made of durable polycarbonate to protect the cab from debris, dust, rain and wind
- Lock & Ride offers easy, toolless installation
- Fully seals at the base for lower protection from the elements, while the open top-half enables airflow

» 2884571

200 EFI '22-24



POLY REAR PANEL

- Made of durable .34 cm polycarbonate, which offers rider protection and visibility
- Installs quickly and easily with P-clamps
- Features scratch-resistant hard coating for enhanced durability

» 2889777

200 EFI '22-24

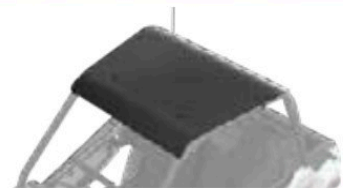

POLY ROOF

- Durable HDPE material provides protection from the weather
- 4-bolt installation
- Integrates with full windshield to provide complete cab coverage

» 2889739

200 EFI '22-24



ROCK SLIDERS

- Add durable protection from rocks, stumps or other debris with steel rock sliders
- Chassis integrated mounting for easy install
- Comes with two steel rock sliders

» 2885146

200 EFI '22-24



REAR STORAGE BAG

- 3 L storage capacity
- Mounts to rear ROPS with a Velcro wrap
- Made to withstand the elements and wear with durable ballistic nylon construction

» 2885145

200 EFI '22-24



PRO ARMOR YOUTH COMBAT WHEEL

- Designed specifically for youth vehicles
- Increased strength and lightweight performance helps overcome obstacles on the trail
- Not compatible with stock lug nuts; Requires metric lug nuts (2877384, 2877385), sold separately

» FRONT • 12" x 7" • 1525222

200 EFI '22-24

» REAR • 12" x 7" • 1525421

200 EFI '22-24



PRO ARMOR YOUTH CRAWLER TIRE

- 25" design provides additional ground clearance
- Improved performance in all types of applications, from rock crawling to desert running
- Double-belted sidewall for additional puncture-resistance

» FRONT/REAR • 25" x 9.5" R12 • 5417953

200 EFI '22-24



PRO ARMOR WHEEL & TIRE SET: COMBAT & YOUTH SAND 8XT

- Not compatible with stock lug nuts; Requires metric lug nuts (2877384, 2877385), sold separately

» FOUR WHEELS & TIRES • 2890260

200 EFI '22-24



PRO ARMOR WHEEL & TIRE SET: COMBAT & YOUTH CRAWLER

- Not compatible with stock lug nuts; Requires metric lug nuts (2877384, 2877385), sold separately

» FOUR WHEELS & TIRES • 2889869

200 EFI '22-24

TREAD DEPTH	TIRE WEIGHT	PLY RATING	SIDEWALL BELTS	LOAD RATING
13mm	10.5 kgs	6	2	437 kgs

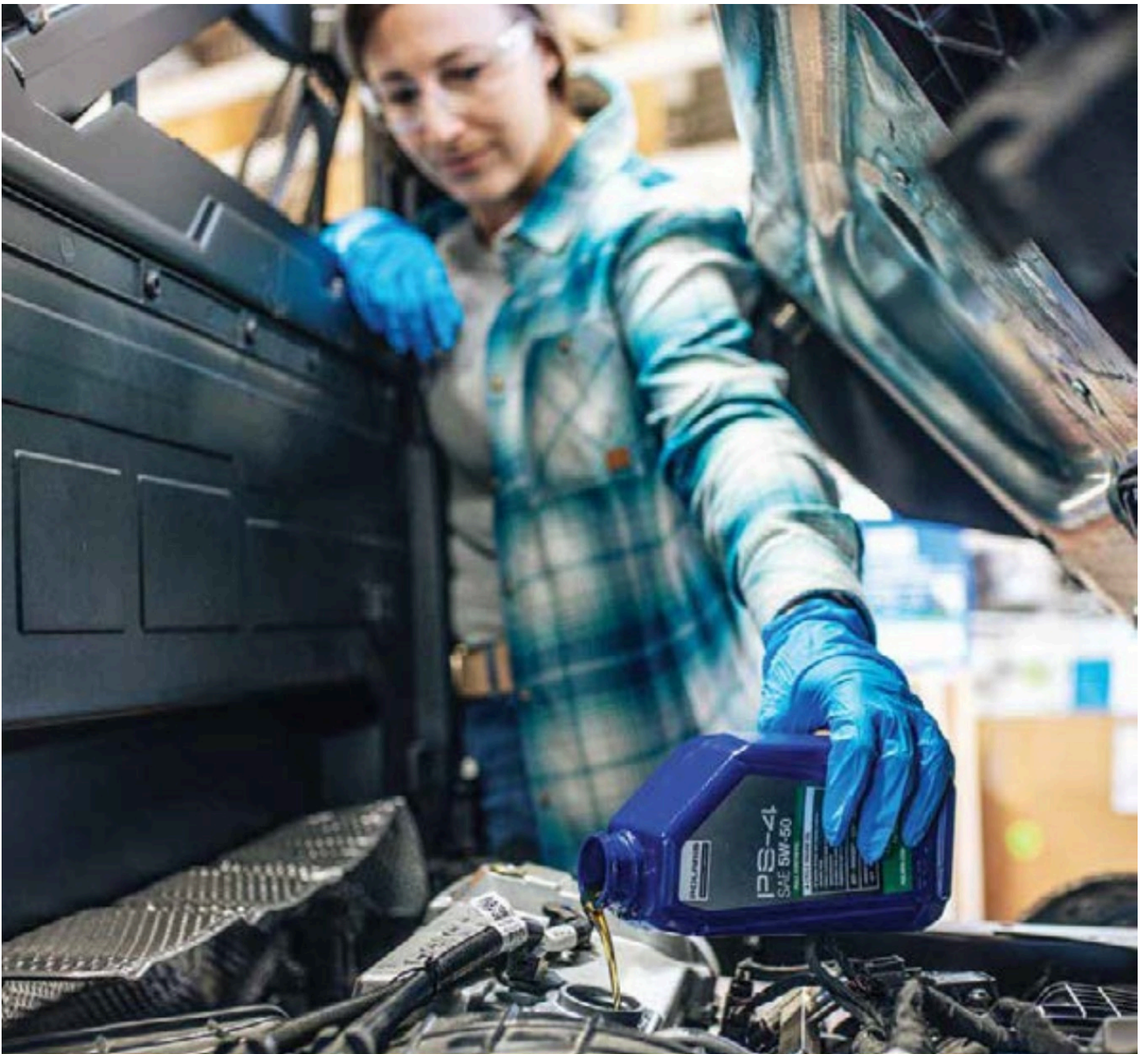

MAINTENANCE & GARAGE

FACTORY APPROVED. Every Polaris vehicle has been engineered and manufactured to deliver performance. Keep it that way by using the same lubricants, cleaners and service parts our factory-trained technicians use.



FOR THE LIFE OF YOUR RIDE

PUSH THE LIMITS WITHOUT SACRIFICING STRENGTH, LONGEVITY AND DURABILITY.
Polaris parts are engineered specifically for your machine, to ensure you get the most out of each ride.

MAINTENANCE TIP

BREAK-IN PERIOD

The break-in period for your new RZR is the first 25 hours of operation, 1 month, or the time it takes to use the first two tanks of fuel (whichever comes first). No single action on your part is as important as a proper break-in period. Careful treatment of a new engine will result in more efficient performance and longer life for the engine.

AIR FILTER

A clogged air filter can restrict air flow to the engine which can lead to reduced engine performance and shortened engine life.

BRAKE PADS

Brake pads should be checked for wear and oil or grease (petroleum products) contamination. Brake discs should be checked for cracks, excessive corrosion or warping.

HALF SHAFTS

Check for tears and punctures in the boot, which can lead to CV joint wear that can contribute to axle failure.

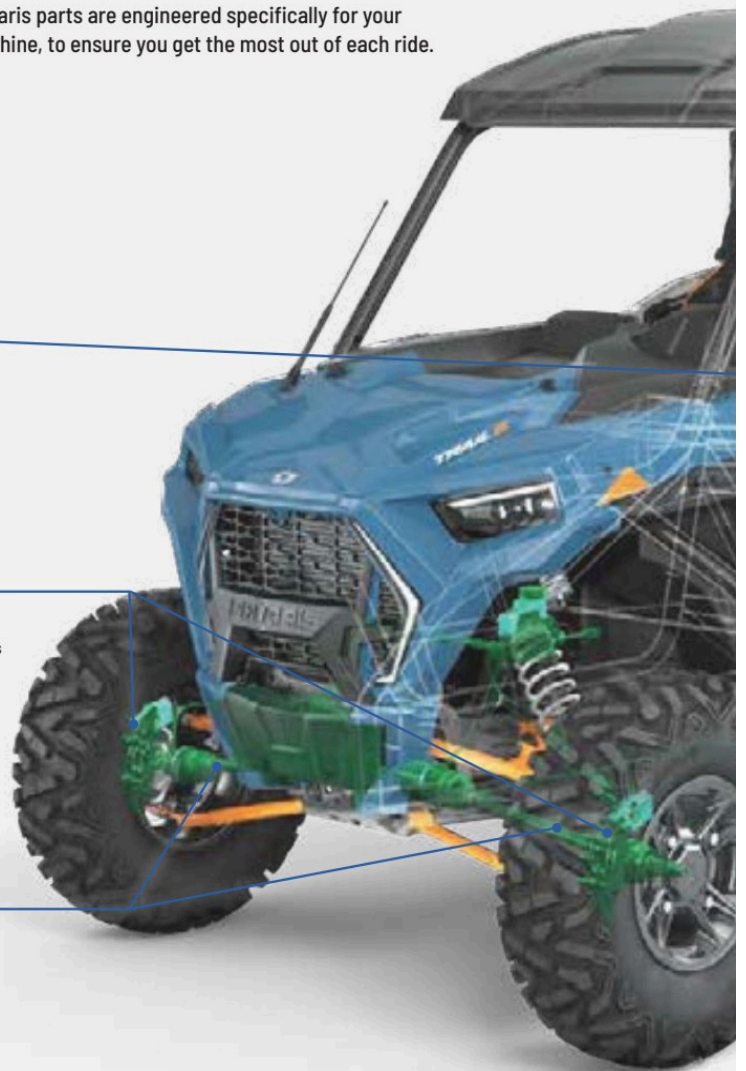

MAINTENANCE SCHEDULE*

BREAK-IN MAINTENANCE	6 MONTHS	12 MONTHS	18 MONTHS
FIRST 25 HRS / 1 MONTH 250 MI / 400 KM	50 HRS 500 MI / 800 KM	100 HRS 1,000 MI / 1,600 KM	150 HRS 1,500 MI / 2,400 KM
ENGINE OIL & OIL FILTER CHANGE	AIR FILTER INSPECT REPLACE AS NEEDED	ENGINE OIL & OIL FILTER CHANGE	BATTERY TEST & CLEAN REPLACE AS NEEDED
GENERAL LUBRICATION ALL FITTINGS, PIVOTS, CABLES, ETC.	GENERAL LUBRICATION ALL FITTINGS, PIVOTS, CABLES, ETC.	DRIVE BELT INSPECT & ADJUST REPLACE AS NEEDED	DRIVE BELT INSPECT & ADJUST REPLACE AS NEEDED
AIR FILTER INSPECT REPLACE AS NEEDED	DRIVE BELT INSPECT & ADJUST REPLACE AS NEEDED	TRANSMISSION FLUID CHANGE	TIRES INSPECT CONDITION & PRESSURE REPLACE AS NEEDED
		AIR FILTER INSPECT REPLACE AS NEEDED	AIR FILTER INSPECT REPLACE AS NEEDED

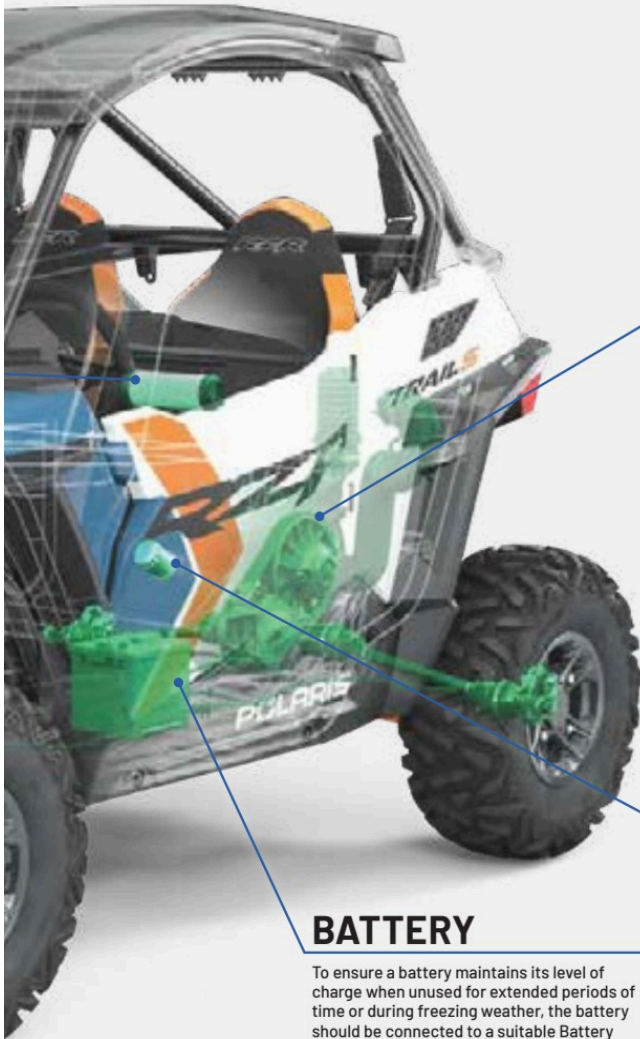

DRIVE BELT

Polaris Engineered belts deliver unmatched performance for your off-road vehicle. Developed and tested on all our engines for all environments and conditions. Check your belt for delamination, hour glassing and glazing.

OUR INVESTMENT

- 64,000+ km of field testing
- Thousands of dyno hours
- 18+ months of development (13,000+ design hours) per belt
- 1,500+ vehicle validation hours
- Collaboration with powertrain and clutch engineers

YOUR ADVANTAGE

- No clutch recalibration
- Less wear and tear due to heat
- Ensure maximum vehicle performance
- More time riding, less time wrenching
- Produced in collaboration with powertrain and clutch engineers to ensure a perfect fit, maximum performance and ultimate durability

BREAK-IN PERIOD

- Use lower gear (if available) while varying speeds and avoid wide open throttle for 8-16 km
- If no low gear is available, vary at moderate speeds while avoiding wide open throttle for 80 km

OIL FILTER

Change oil filters with every oil change to provide the best engine protection and keep the engine operating at peak performance.

BATTERY

To ensure a battery maintains its level of charge when unused for extended periods of time or during freezing weather, the battery should be connected to a suitable Battery Charger. Be sure to check for corrosion from the terminals to the ends of the cables.

FOLLOW RECOMMENDED SERVICE INTERVALS IN THE OWNER'S MANUAL

24 MONTHS

200 HRS | 2,000 MI / 3,200 KM

ENGINE OIL & OIL FILTER
CHANGE

BRAKE PADS & FLUID
REPLACE BRAKE FLUID

SPARK PLUGS
INSPECT
REPLACE AS NEEDED

AIR FILTER
INSPECT
REPLACE AS NEEDED

30 MONTHS

250 HRS | 2,500 MI / 4,000 KM

BATTERY
TEST & CLEAN
REPLACE AS NEEDED

SHOCK ABSORBERS
REPLACE OIL & SEALS

DRIVE BELT
INSPECT & ADJUST
REPLACE AS NEEDED

GENERAL LUBRICATION
ALL FITTINGS, PIVOTS, CABLES, ETC.

AIR FILTER
INSPECT
REPLACE AS NEEDED

36 MONTHS

300 HRS | 3,000 MI / 4,800 KM

ENGINE OIL & OIL FILTER
CHANGE

AIR FILTER
INSPECT
REPLACE AS NEEDED

TRANSMISSION & GEARCASE
REPLACE FLUIDS

FOR A COMPLETE MAINTENANCE SCHEDULE, CHECK YOUR OWNER'S MANUAL

*This is a sample maintenance schedule and is not intended for use in your specific vehicle. Please reference and use your owners manual to ensure proper maintenance and vehicle care.

OIL

PS-4 FORMULATIONS BEST PROTECTION, BEST PERFORMANCE

Our PS-4 engine oils provide ultimate performance and protection, they're formulated with exclusive additives to keep engines clean from deposit buildup. These powersports-grade full synthetic oils help maximize power and protect your engine for the long term.



PS-4 5W-50 FULL-SYNTHETIC OIL

Optimal for ambient operating temperatures of -40° C to 38° C

1L 502484 4L 502485 25L 502486 60L 502487 200L 502488

PS-4 0W-50 EXTREME FULL-SYNTHETIC OIL

Optimal for ambient operating temperatures of -43° C to 54° C.

1L 503220 4L 503221 25L 503233 > 60L 503236 > 200L 503235

PS-4 5W-50

OIL CHANGE KITS

These convenient kits include everything needed including filter and oil volume per vehicle

PART NUMBER	VEHICLE FITMENT
502541	SINGLE 570, TWIN 600, TWIN 700, TWIN 800
502543	RANGER/RZR 900/1000
502542	SPORTSMAN 550/850/1000

POLARIS INVESTS IN EACH OIL AT & ABOVE THESE LEVELS

**12+ DEDICATED
TEAM MEMBERS**
FOCUSED ON POLARIS OIL

**18+
MONTHS**
DEVELOPMENT & TESTING

**76,000+
HOURS**
DYNO TESTING

**3.5 MILLION+
KILOMETERS**
FIELD TESTING



POLARIS
EXTREME
 SYNTHETICS

PS-4 EXTREME SYNTHETIC 0W-50

- Our best extreme high and low temp formula, excellent for high temperatures and racing, even at temps of 54°C, plus easier cold starting even below -42°C
- Expect the best in wear protection thanks to premium PAO and ester base stocks combined with a balance of moly and ZDDP additives
- Polaris exclusive clean engine additive system reduces deposits and carbon build-up for peak performance and power

THE BEST PROTECTION, MAXIMUM PERFORMANCE

- Powersports grade full synthetics provide long lasting engine protection
- At least 40% improved wear protection compared to all aftermarket oils tested (see engine wear test chart)
- Polaris exclusive clean additive system
- At least 50% less deposits than all aftermarket oils tested (see deposit test chart)
- Cleaner engine with less deposits means consistent maximum power and performance

WIDEST VISCOSITY FOR ULTIMATE PROTECTION



ENGINE WEAR TEST

LOWER NUMBER = LESS ENGINE COMPONENT WEAR
 LESS WEAR ON PARTS MEANS LONGER ENGINE LIFE

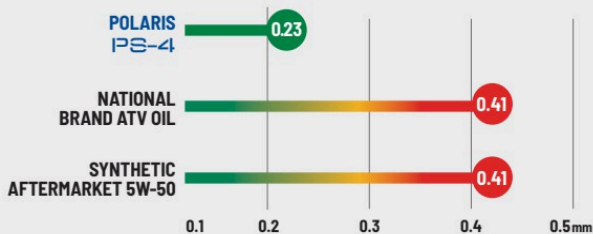

ASTM D4172. In 3rd party testing against 9 competitive products Polaris had 40% or better wear protection compared to all of the tested products. Numbers represent mm of wear scarring measured. Test measures wear at contact points, wear scar is measured for its length and width (in units of mm). Lower wear numbers mean better wear protection and friction reduction.

DEPOSIT TEST

LOWER DEPOSITS = MAXIMUM POWER

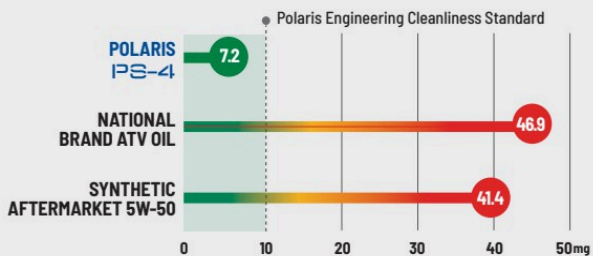

ASTM D6335. In 3rd party testing against 9 competitive products Polaris PS-4 had less than half the deposits compared to the next closest product. No other tested products met Polaris Engineering standards for deposit cleanliness. Test measures mass of deposits in mg in high temp, high stress test cycles. Higher deposits will impact engine power and performance.

MAINTENANCE FLUIDS



ENGINE OIL

Maximum protection for your 4-cycle engine.

» SEE P. 116



AGL

Protects transmission components against wear, corrosion, oxidation and foam in transmissions. Unique viscosity provides all-season performance including cold flow protection.

- » 1 L • 502505
- » 25 L • 502507
- » 200 L • 502508

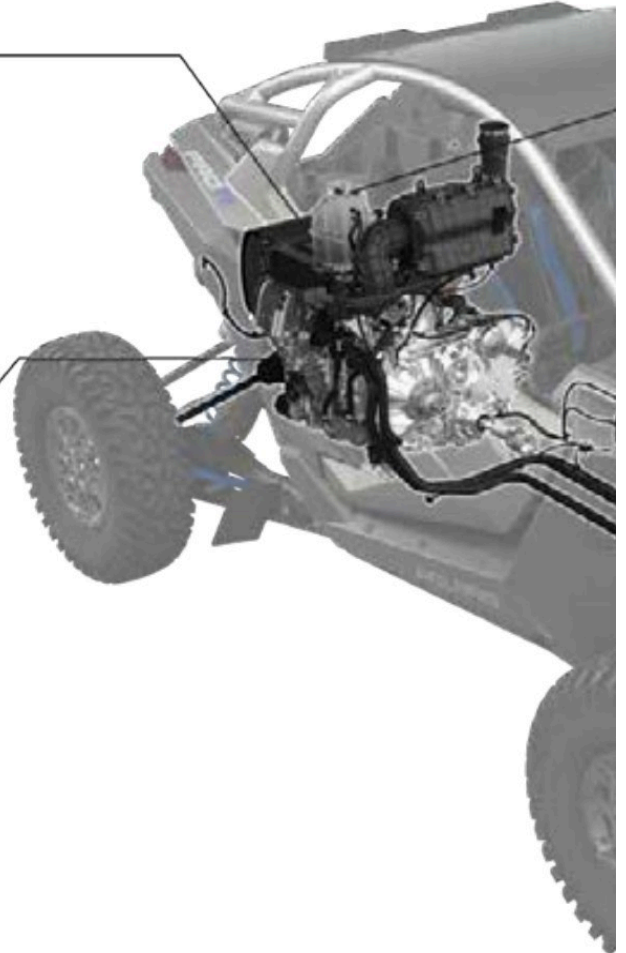

PREMIUM GAS SHOCK OIL

- » 1 L • 502518



ALL-SEASON GREASE TUBE

Specialized water-resistant lubricant

- » 400 g • 502538



ANGLE DRIVE FLUID

Provides maximum protection in high-torque/high-pressure conditions. Reduces wear, corrosion and oxidation in rear angle drives

- » 1 L • 503320
- » 25 L • 503318
- » 202 L • 503317

SPORTSMAN, RANGER, RZR
ANGLE DRIVE GEAR CASE SYSTEMS



ANTI-FREEZE

Prevent corrosion on metal components, eliminate scaling and maximize cooling system performance.

- » 1 L • 502566
- » 25 L • 502567
- » 206 L • 502568

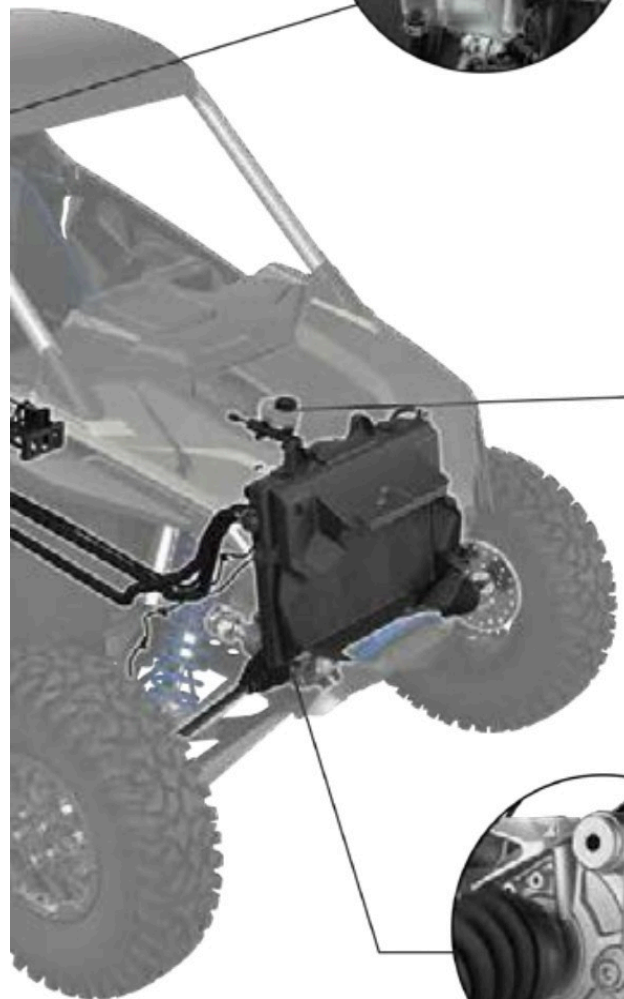

DOT 4 BRAKE FLUID

A high-quality brake fluid designed for use in Polaris hydraulic brakes.

- » 250 ML • 502526



DEMAND DRIVE FLUID*

Proprietary formulation prevents clutch slippage and chatter and reduces component wear and corrosion.

- » 1 L • 502563
- » 25 L • 502564
- » 200 L • 502565

*RZR MODELS EXCEPT PRO R / 4



*Pro R/4 '22-24 require Angle Drive Fluid (503320)



CARBON CLEAN

Ultimate fuel and injection system cleaner

- » 125 mL • 502528



FUEL STABILIZER

Fuel Stabilizer prevents ethanol corrosion and stabilizes fuel for up to 2 years. Dual-antioxidant formula protects against gum and varnish for easy starting.

- » 125 mL • 502519

HD HEAVY DUTY PARTS

All Polaris parts are developed and tested to help you get the most out of your ride. We're taking the passion of our riders, workers and outdoor enthusiasts to the next level with HD Parts.

Engineered and designed for:

- Greater durability
- Enhanced performance
- Greater wear and tear capabilities
- All weather conditions



DRIVE BELTS

The enhanced rubber material compound in these belts keep them cool in extreme heat, while our proprietary cord treatment process maximizes the transfer of horsepower to the ground for those customers hauling heavy loads.



OE	HD HEAVY DUTY PARTS
3211148	3212326
3211113	3212328

OIL FILTERS

The advanced synthetic material built into these filters offers the highest debris holding capacity, maintains oil flow and maximizes performance.

OE	HD HEAVY DUTY PARTS
2520799	2522498
2540086	2522485



WHEEL BEARINGS

Fully sealed for added protection against intrusions. Made of a higher grade steel for extended life in extreme conditions.

LOCATION	OE	HD HEAVY DUTY PARTS
FRONT WHEEL BEARINGS	3514924	3515090
REAR WHEEL BEARINGS	3414924	3515090



NEW BATTERY*

AGM fully sealed for optimal starting power with maximum reserve capacity, designed for highly accessorized vehicles and extreme operating conditions.

OE	HD HEAVY DUTY PARTS
4014132	4081855

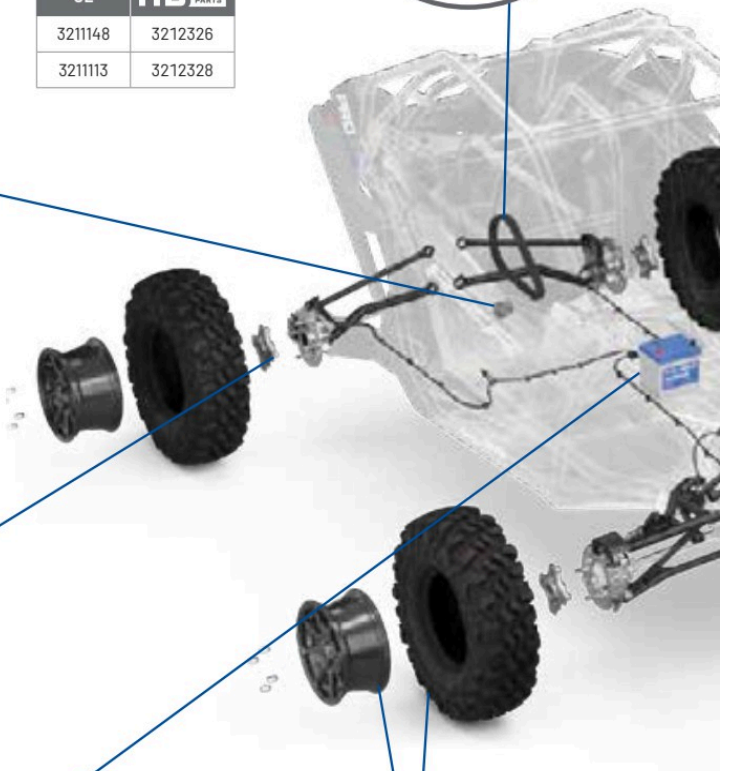

WHEELS & TIRES

Class leading durability for off-road performance and traction for confident driving in extreme conditions.

- » 1524022-458 • HD WHEEL - 14x7*
- » 5417507 • PRO ARMOR HD-K - 29x10R14*
- » 5457498-458 • HD WHEEL CENTER CAP*
- » 5415756 • PRO ARMOR XD-K FRONT
- » 5415757 • PRO ARMOR XD-K REAR

* SHOWN



*Check with your local dealer for availability.

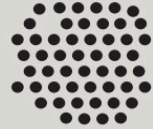

SAND



MUD



WATER



EXTREME COLD



EXTREME HEAT UP TO 54°C



HEAVY PAYLOADS



EXTENDED LIFE

MAINTENANCE & GARAGE

MAINTENANCE

OIL & LUBRICANTS

MAINTENANCE FLUIDS

HD PARTS

SERVICE PARTS

CLEANERS & TRAILERING



BUSHINGS

The advanced material compound of the bushings enables tighter tolerances to reduce overall wear on the system, while the superior triple lip sealing prevents intrusion of the elements.

LOCATION	OE	HD <small>HEAVY DUTY PARTS</small>
FRONT UPPER BUSHINGS	5439874	1543367
	5439730	
	5436973	1543326
FRONT LOWER BUSHINGS	5439874	1543367
	5439730	1543326
	5436973	
REAR UPPER BUSHINGS	5439874	1543367
	5439730	
	5436973	1543326
REAR LOWER BUSHINGS	5439874	1543367
	5439730	
UPPER HUB BUSHINGS	5436832	1543367

CV BOOT KIT

TPE rubber compound for maximum puncture and tear resistance, includes (1) boot, grease and clamp to replace OE stock part. Provides increased durability for riding in extreme conditions.

OE	HD <small>HEAVY DUTY PARTS</small>
2204102	2209922
3236165	2209923

BRAKE PADS

Engineered to provide longer life and better stopping power while riding in extreme conditions.

OE	HD <small>HEAVY DUTY PARTS</small>
2205949	2208933
2203318	2208936
2202413	2208934
2202412	2208935

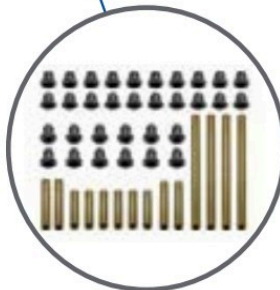
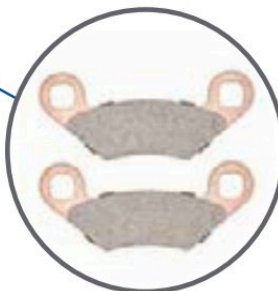

BUSHING KITS

Easily update the entire front and rear suspension.

» 2830564
RZR 800 '08-'14, RZR 800 S '09-'14

SERVICE PARTS

**POLARIS ENGINEERED SERVICE PARTS
DELIVER UNMATCHED PERFORMANCE
AND FIT FOR YOUR OFF-ROAD VEHICLE.**

All service parts are engineered specifically for your machine. Which means everything is designed, tested and perfected to maximize the life of your ride. Getting Polaris Engineered parts is a decision that pays off in the long run, because it ensures there is a long run.

**VISIT YOUR POLARIS DEALER TO
SHOP FOR SERVICE PARTS.**

OVER
100,000
PARTS
AVAILABLE!



FOR THE LIFE OF YOUR RIDE

Maintenance is the key to keeping your Polaris off-road vehicle performing at its peak. Items like belts, lubricants, and batteries represent only a few of these critical items engineered specifically by Polaris.



POLARIS ENGINEERED DRIVE BELTS

TESTED, PERFECTED

We test each belt on the intended vehicle – we don't just try to make an existing belt "just work".

– Amery Kuhl, Polaris CVT System Engineer

OUR INVESTMENT

- 32,187 km of field testing
- Thousands of dyno hours
- 18+ months of development (3,000+ design hours) per belt
- 1,200+ vehicle validation hours
- Collaboration with powertrain & clutch engineers

YOUR ADVANTAGE

- No clutch recalibration
- Less wear & tear due to heat
- Ensure maximum performance of your vehicle
- More time out riding, less time wrenching

**OUR INVESTMENTS ENSURE POLARIS BELTS
OUTPERFORM YOUR EXPECTATIONS.**

KEEP IT CLEAN

CLEAN

ALL-PURPOSE CLEANER

- Professional cleaner, which is formulated with a low pH-value. The product spreads well on surfaces and adheres on them for effective cleaning action. Perfectly compatible with rubber, plastic and painted surfaces. The formulation is biodegradable.

» 500 mL • 502309

SHINE

INSTANT SHINE & DETAILER

- The INSTANT SHINE AND DETAILER is developed for cleaning action without water. Removes insects, dust and dirt with almost no effort. Applicable for plastics, visors, windcreens, paint and metal. The wipe and shine formulation makes surfaces shine, works water repellent and also has an antistatic effect. Perfect for customers living in urban areas with no access to water, for bike trips or showroom bikes.

» 500 mL • 502546



BRING IT EVERYWHERE

TRAILERING



CALIBER RAMP PRO

- Designed for ATVs and UTVs up to 127 cm wide
 - Integrated grip glides for ultimate traction
 - Folding sides for easy transportation and storing
- » 132 cm x 229 cm • 2884576



ALUMINUM ARCHED LOADING RAMPS

- Capacity for up to 1,361 kg
- » 193 cm x 30.5 cm
907 kg • 2875384
- » 224 cm x 30.5 cm
1,361 kg • 2875386



LIGHTWEIGHT TRI-FOLD RAMPS

- Ramp folds up for transport
- Capacity for up to 681 kg
- Safety straps included
- » 183 cm x 130 cm • 2875385
- » 208 cm x 130 cm • 2875860



FOLDING ALUMINUM ARCHED RAMPS

- Ramp folds up for transport
 - Up to 680 kg total capacity, 340 kg per individual ramp
 - Safety straps included
- » 224 cm x 30.5 cm • 2875387

COVERS

TRAILERABLE COVER BY POLARIS

PRO XP

» 4-SEAT • 2883989
PRO XP 4 '20-24

» 2-SEAT • 2883764
PRO XP '20-24

XP

»  4-SEAT • 2884522
XP 4 '24

»  2-SEAT • 2884521
XP '24

TRAIL S / TRAIL

» 2-SEAT • 2885092
TRAIL S '21-24, TRAIL '21-24



CV BOOT REPAIR KIT*

FIX ON THE GO | TEMPORARY COVERAGE

- A quick trail-side fix to increase trail time
- The flexible and durable boot material expands over a cone tool for CV boot repairs, without disassembling CV axles
- Universal fit – works as a temporary fix for most powersports axles
- All components fit inside the cone, and a cover is provided for compact durable storage
- Easily fits in a cargo box, attached to the roll cage, in the glovebox or many other storage locations



Items shown are contained inside cone

UTV CV BOOT REPAIR KIT

Kit includes the following items:

- (1) Expandable XL CV Boot
 - (1) Reusable Cone Tool
 - (2) CV Boot Clamps
 - (1) Tube of Silicone Lube
 - (1) Grease Packet
 - (1) Cone Cover
- » 2830526

UTV TRAIL BOOT ONLY

» 2830527

ATV

» CV REPAIR KIT 2830528

» TRAIL BOOT ONLY 2830529

HOW TO INSTALL

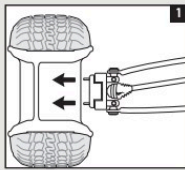

Remove wheel and axle nut.

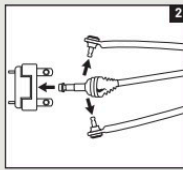

Remove brake caliper, hub, tie rod and upper and lower ball joints.

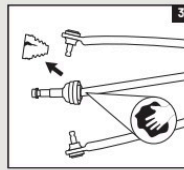

Remove old boot and clean joint.

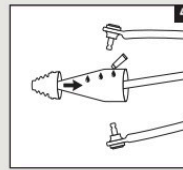

Spread silicone lube on entire cone tool. Slide boot over cone tool, large end first. See package for outer boot instructions.

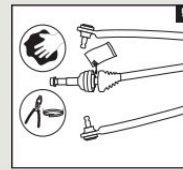

Empty the bag of grease into the CV joint/boot, clean sealing points and install clamps.

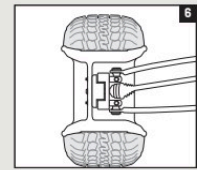

Reassemble tie rod, ball joints, brake caliper, axle nut, tire and wheel.

Refer to your service manual for further instructions and torque specifications.
*Designed for temporary CV boot repair. Purchase the OEM CV Boot for a permanent repair.

HITCHES



HITCH WITH 5 CM BALL

- 3:1 Hitch: ball, hook and pin design
 - Rust resistant steel with powdercoat finish
 - Removable ball, HD 1.6 cm pin and clip
- » 5 cm x 5 cm RECEIVER • 2830522
» 3 cm x 3 cm RECEIVER • 2830523



4.8 CM BALL

- 4.8 cm replacement ball for hitch
 - Designed to work with 3:1 Hitch
- » 2830524



RECEIVER HITCH

» 5 cm RECEIVER TONGUE • 2875320



TRAILER BALL 1.9 CM SHANK

» 4.8 cm BALL • 2877602
» 5 cm BALL • 2877603

STRAPS & ROPES



RECOVERY STRAP

- 5 cm x 9 m
 - 8,165 kg maximum load, 4,082 kg maximum vehicle weight
 - Comes with carry bag
- » 2884033



RATCHET STRAP

- 3.8 cm x 4.6 m straps, 2-pack
 - Heavy duty webbing
 - 2,495 kg maximum load, working load
- » 2884031



RATCHET STRAP

- 5 cm x 6.1 m Ratchet Straps
 - Heavy duty webbing, floating D-rings, double J-hooks
 - 4,536 kg maximum load, 1,497 kg working load
- » 2884032



SHOCK STRAPS

- 3.8 cm 1,361 kg breaking strength
 - Keeps tension on tie-down straps to secure load
 - 2-Pack
- » 3.8 cm x 4.6 m • 2883296
» 3.8 cm x 2.1 m • 2883295



SPARE TIRE RATCHETING Y-STRAP

» 2689506

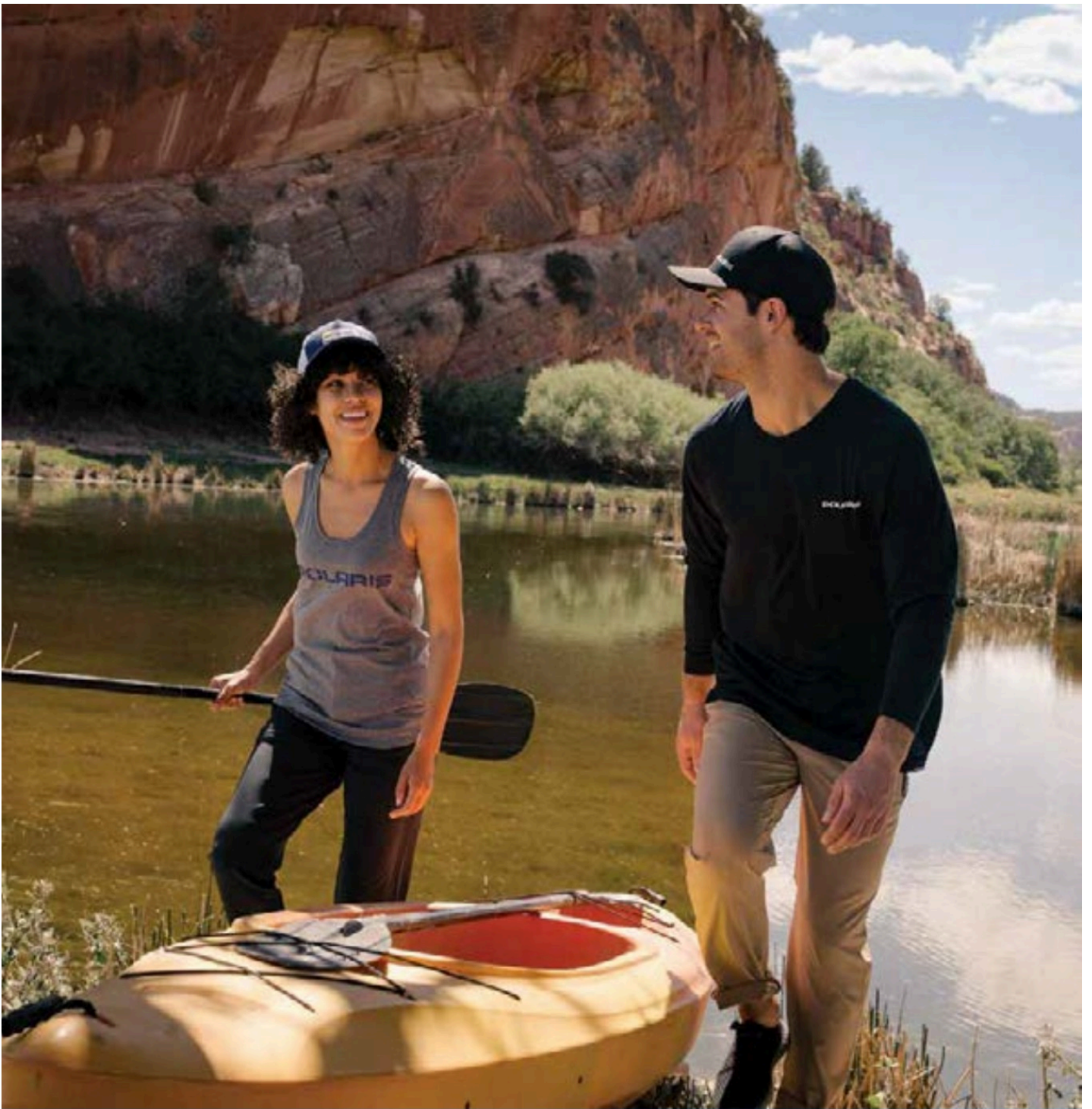

APPAREL

FIT FOR ANY ADVENTURE. For outdoor enthusiasts looking for gear that's purposefully built to stand up to the fun and challenging experiences Polaris vehicles enable. Each piece of apparel and equipment bearing the name Polaris is crafted by outdoor enthusiasts, for outdoor enthusiasts. They are a badge of honor – representing what the Polaris brand stands for – a passion to simply be outside doing what you love.



APPAREL

RACING COLLECTION

JERSEYS & GLOVES
& POLARIS RACING

HELMETS & GOGGLES

RZR APPAREL
& MERCH

HEMEN'S APPAREL

BALL CAPS & BEANIES

WOMEN'S APPAREL

HOME & COLLECTIBLES

> RACING COLLECTION



HELMET

- Polycarbonate shell
- Removable & washable lining
- Double lens system with integrated sun visor
- Quick release micrometric adjustment system
- Weight: 1450 g (+/-50 g)

NEW Black Matte | XS-2XL | 2802408
 White Gloss | XS-2XL | 2802311
 Dark Gray Matte | XS-2XL | 2802312

ECE 22.06



- 1 shell and 2 EPS: XS-M, L-XXL
- ECE 22-06 approved



BOOTS

- Waterproof and breathable lining
- Full-grain oil treated leather upper
- Specific ATV double density compound rubber sole
- Adjustable Velcro® closure
- Replaceable/adjustable plastic buckles
- Anti-bacterial replaceable footbed
- CE-approved motorcycle boots EN 13634:2017

Black | EU39 - 47 | 2802313
 Brown | EU39 - 47 | 2802314



NEW SPORT JACKET

- Light and water repellent jacket
- Ideal for ATV and SxS ride in wet weather
- 2 zipped pockets on the outside and 2 inside pockets
- Laser cut under the arms for better ventilation

Black | XS-4XL | 2802409



NEW SPORT PANTS

- Light and water repellent pant
- Ideal for ATV and SxS in wet weather
- Ergonomic cut and stretch to gain comfort
- 1 zipped pocket
- Belt adjustment with micrometric buckle

Black | XS-4XL | 2802410



NEW TECHNICAL SHIRT

- 100% polyester
- Indelible sublimated graphics
- Hemmed edging
- Lycra cuffs and collar

Men's | Black | S-3XL | 2802404
 Women's | White | S-2XL | 2802405



SAFETY GLOVES TOUCH



- CE-approved motorcycle glove EN 13594:2015
- Touch screen compatible
- Silicon print on fingers to improve grip
- Neoprene cuff with Velcro® tightening
- Reinforcements patches for safety and comfort

Khaki | S-3XL | 2802309
 Black | XS-7, 3XL-13 | 2802103



NEO GLOVES



- CE-approved motorcycle glove EN 13594:2015
- 100% synthetic neoprene glove
- Touch screen compatible
- Knuckle protected
- Reinforcements patches for safety and comfort

Black | XS-7, 3XL-13 | 2802310



SF TECH GLOVES TOUCH



- CE-approved motorcycle glove EN 13594:2015
- Touch screen compatible
- Knuckle-protected
- Silicon print on fingers to improve grip
- Neoprene cuff with Velcro® tightening
- Reinforcements patches for safety and comfort

Khaki | S-3XL | 2802308
 Black | XS-7, 3XL-13 | 2802102



TECHNICAL JACKET

- Water-resistant jacket
- Ultra-light thanks to polyester ripstop and softshell for optimal comfort
- Ventilated lining
- Hydration hose outlet
- Zip ventilation system on body and back

Black | S-3XL | 2802301



TECHNICAL PANTS

- Water-resistant pants
- Ultra-light thanks to polyester ripstop, softshell and 1000-D Cordura stretch fabric on the back for optimal comfort
- 2 cargo type pockets
- Zip ventilation system
- Zip and Velcro® adjustment at the bottom of the pants

Black | S-3XL | 2802302



NEW WATERPROOF JACKET

- 100% polyester 2,5 Layer stretch fabrics
- PU membrane waterproof and breathable 3000 mm / 3000 gr
- All seams taped and WR main zipper
- Adjustable hood
- Ventilation system on back to improve ventilation

Black | S-3XL | 2802403



PUFFY JACKET

- Top body and shoulder polyester woven 3000 mm/3000 gr + welded quilting
- Lower body nylon 380T downproof 80gr padding
- Inner elastic bottom tightening
- Two external pockets with easy-grab puller

Black | S-3XL | 2802303



PADDED JACKET

- Shoulder and hood softshell waterproof and breathable 3000 mm/3000 gr
- Lower body and sleeve, polyester woven waterproof and breathable 3000 mm/3000 gr
- Quilted lining with 80 gr padding
- Elasticized lower body tightening
- Two external pockets with easy-grab puller

Black | S-3XL | 2802306



RACING PARKA

- Waterproof and breathable 3000 mm/3000 gr
- Quilted lining with 80 gr padding
- 2 upper body outer pockets and 2 bottom cargo pockets
- Sleeve pocket with lazer holes
- +TPU welded film on zipper

Black | S-3XL | 2802307



BODYWARMER

- Upper body and side panels in softshell waterproof and breathable 3000 mm/3000 g
- Lower body nylon downproof
- Padding 80 g
- Two external pockets with easy-grab puller

Khaki | S-3XL | 2802304
Black | S-3XL | 2802101



RACING SOFTSHELL

- Softshell waterproof and breathable 3000 mm/3000 g
- Removable hood
- Four external pockets with easy-grab puller

NEW Women's | Black | S-XL | 2802402
Men's | Khaki | S-3XL | 2802305
Men's | Black | S-3XL | 2802003



HYBRID JACKET

- Sleeves in softshell waterproof and breathable 3000 mm/3000 g
- Body nylon downproof
- Padding 80 g
- Three external pockets with easy-grab puller

NEW Khaki | S-3XL | 2802401
Black | S-3XL | 2802004

> JERSEYS & GLOVES



OFF-ROAD RIDING JERSEYS

Mesh ventilated panels for maximum airflow.
Elastic sleeves with non-restrictive cuffs.

OFF-ROAD RIDING GLOVES

Adjustable wrist closure for a custom fit.
Silicon finger grips and neoprene knuckle protection.
Gloves are not CE-approved.



	SIZE	 N/A	 N/A				
		A RED	B LIME/OLIVE	C BLACK	D ORANGE	E TEAL	F BLUE
ADULT JERSEY	S-3XL	2864637	2864638	2862718	2862719	2862720	2862722
GLOVES	S-3XL	2864635	2864636	2862726	2862729	2862727	2862728
YOUTH JERSEY	S-XL	2864639	N/A	2862723	N/A	2862724	2862725

NECK GAITERS

Keep the sun off your neck and the dust off your face. Stretchy and seamless material that is UPF 15-18 for sun protection and moisture-wicking.



Blue 2833138	Lime 2861952
Camo 2861948	RZR Scenic 2861949
Black 2861953	RZR Black 2861951
Red Retro 2861950	RZR Red 2833139

POLARIS
RACING

TEAM POLARIS IS PUSHING RACING TO THE LIMIT.

Show your passion for the thrill with our lineup of Polaris Racing apparel.



NEW
POLARIS RACING FULL ZIP HOODIE

Black | S-3XL | 2864594



NEW
POLARIS RACING TEE

Black | S-3XL | 2864619



NEW
POLARIS RACING CAP

Black | S/M | 2864714
Black | L/XL | 2864581



NEW
POLARIS RACING BEANIE

Black | 2864700



POLARIS RACING MUG

2864716



POLARIS RACING LED SIGN

26.7 cm x 22.9 cm | 2862737

APPAREL

RACING COLLECTION

JERSEYS & GLOVES
& POLARIS RACING

HELMETS & GOGGLES

RZR APPAREL
& MERCH

MEN'S APPAREL

BALL CAPS & BEANIES

WOMEN'S APPAREL

HOME & COLLECTIBLES

> HELMETS



CARBON FIBER
BLACK
S-2XL | 2833158

FOR POLARIS FIDLOCK. IGNITE

DELTA V COMMANDER

NO LONGER A HELMET, IT'S A COCKPIT

SHELL

- Carbon fiber
- Lightweight polycarbonate

WEIGHT

- Up to 1,832 g

FEATURES

- The Delta V Commander features an integrated communication system, infinity style sealed IGNITE heated shield, and ergonomic design
- Features in-helmet JBL® speakers for audio and an integrated microphone to connect up to 14 users in a group with the best sound and noise cancellation for all your rides
- Venturi Vent Ducting, an integrated spoiler, and low-profile antennae keeps this helmet sleek, quiet, and fog-free all day on the trails
- 12-volt power input on left side powers shield, comms, and chase light with controls for bright, normal, and off positions
- Battery power for up to 10 hours of riding
- Connect via Bluetooth® to your music, phone, maps, and sled
- DOT/ECE 22.06 dual certified helmet shell and luxurious liner
- Fidlock® chinstrap for easy on and off



CARBON FIBER
WHITE
2833152

FOR POLARIS FIDLOCK. IGNITE

DELTA V CARBON IGNITE

BUILT SPECIFICALLY FOR SUSTAINED LONG RIDES,
AT SPEED, IN COLD TEMPERATURES

S-3XL

SHELL

- Carbon fiber

WEIGHT

- Up to 1,807g

FEATURES

- Hand-laid carbon fiber construction for lightweight and durable performance
- Powered helmet - 12 volt power input on left side to power shield
- IGNITE heated shield is powered by your snowmobile's battery, and comes with all required connection cables
- Compatible with 509 12 volt power pack system, for 10 hours of riding
- Innovative Venturi Vent pulls moist air from helmet without cold wind coming into helmet
- 2 shell sizes, and dual density EPS for optimal fit
- Premium liner for a comfortable and quiet fit
- Ignite dual pane heated shield for fog-free performance
- DOT/ECE 22.06 dual certified helmet shell
- Fidlock® chinstrap for easy on and off



BLACK
S-3XL | 2833151



WHITE
S-3XL | 2833150



CARBON FIBER
BLACK
2833153



ORANGE/TAN
2864559

TENACITY 4.0

COMBINATION OF MODERN STYLE & PREMIUM PROTECTION WITH INCREDIBLE VALUE

XS-2XL

SHELL

- Shock-resistant, injection-molded thermoplastic

WEIGHT

- 1,500g

FEATURES

- Through-flow, full-helmet ventilation
- ProClip quick release chin strap allows you to fasten the chin strap in seconds
- Removable breath box and removable, washable liner
- Tool-less adjustable roost shield
- DOT- and ECE 22.06-approved



BLACK/LIME
2864560

RADIANT GREEN
2833142

BLACK
2861557

BLACK/GRAY
2861558

WHITE/RED
2861561

BLUE
2833143

> GOGGLES



NEW
OLIVE/LIME
2864546

509 KINGPIN CE

PREMIUM MATERIALS, ATTRACTIVE PRICE

FEATURES

- Built for off-road, the oversized spherical lens delivers optimal peripheral vision
- Metal tear-off posts provide strength and durability
- Quick-change technology allows you to run the best lens tint for conditions



STEALTH
2862560



BLUE
2862562



NEW
ORANGE
2864545

509 MX6 CE

SUPER WIDE FIELD OF VIEW, ENGINEERED FOR DIRT

FEATURES

- PC outer lens with anti-scratch coating, and internal anti-fog coating
- Outriggers with latch system for quick lens change
- 45mm strap with silicone to hold strap in place



BLACK
2862557



RED/BLACK
2862558

APPAREL

RACING COLLECTION

JERSEYS & GLOVES
& POLARIS RACING

HELMETS & GOGGLES

RZR APPAREL
& MERCH

MEN'S APPAREL

BALL CAPS & BEANIES

WOMEN'S APPAREL

HOME & COLLECTIBLES

> RZR APPAREL & MERCH



RZR PATCH CAP

NEW Cypress | S/M: 2864747 | L/XL: 2864748
 Gray/Blue | S/M: 2833514 | L/XL: 2833515
 Black/Red | S/M: 2860607 | L/XL: 2860608



RZR FLAT BILL

NEW Red | 2864746
 Black | 2862596
 Navy | 2861546



RZR PRO CAP

Black | 2833135
 Gray | 2862546



NEW
RZR LIFE TEE

Navy | S-3XL | 2864727
 Red | S-3XL | 2864728



NEW
ROCK IT TEE

Men's | Navy | S-3XL | 2864732
 Men's | Red | S-3XL | 2864733
 Youth | Navy | S-XL | 2864731



RZR TEE

NEW Olive | S-3XL | 2864744
NEW Red | S-3XL | 2864745
 Black/Red | S-3XL | 2861936



NEW

**RZR PERFORMANCE
LONG SLEEVE**

Black/Gray | S-3XL | 2864729
Blue/Gray | S-3XL | 2864730



NEW

RZR UPF HOODIE TEE

Dark Gray | S-3XL | 2833074
Orange | S-3XL | 2833075



NEW

RZR FULL ZIP LOGO HOODIE

Cypress/Orange | S-3XL | 2864725
Black/Lime | S-3XL | 2864724



NEW

RZR FULL ZIP TECH HOODIE

Black | S-3XL | 2864738
Blue | S-3XL | 2864739
Orange | S-3XL | 2864740



RZR VAPOR HOODIE

NEW Orange | S-3XL | 2864741
Black | S-3XL | 2862495
Gray | S-3XL | 2869593



NEW

RZR GEAR UP TEE

Purple Frost | S-3XL | 2864734
Heather Gray | S-3XL | 2864735



NEW

RZR DUNES LONG SLEEVE TEE

Black | S-3XL | 2864736
Heather Gray | S-3XL | 2864737



RZR LIGHTWEIGHT HOODIE

NEW Dark Gray | S-3XL | 2864726
Dusty Rose | S-3XL | 2862571
Sage | S-3XL | 2862731



NEW

RZR VAPOR HOODIE

Gray | S-3XL | 2864742
Olive | S-3XL | 2864743

> MEN'S APPAREL



BLUE
2864518



GRAY/RED
2833029



CYPRESS
2864517



CAMO
2861543



BLUE
2833028



BLACK
2861434

FORCE PUFFER JACKET

PACKABLE JACKET OFFERS LIGHTWEIGHT PROTECTION & INCREDIBLE WARMTH

S-3XL

- 140g 3M® Thinsulate™
- Two external hand pockets, one internal media pocket
- Rugged YKK® zippers
- Compactable into travel pocket

SOFTSHELL JACKET

VERSATILE LIGHTWEIGHT JACKET THAT'S PERFECT FOR EVERYDAY WEAR

S-3XL

- Casual jacket armed with rugged and warm features for everyday wear
- Superior DWR prevents precipitation from saturating the jacket's exterior
- Lined with soft fleece for warmth
- Removable hood and underarm venting, three external pockets and one internal chest pocket



BLACK/GRAY
2864524

RED
2833026

BLUE/ORANGE
2862567



BLUE
2864525

BLACK/LIME
2833024

TAN
2862450

TITAN MID-LAYER

VERSATILE MID-LAYER CAN BE WORN ALONE OR AS AN EXTRA LAYER

S-3XL

- 319g Polartec® Thermal Pro® Rib Sweater provides great warmth
- Breathable material moves sweat to the outer surface
- Nylon overlay is comfortable and light

NORTHSTAR MID-LAYER

EXTREMELY WARM YET BREATHABLE MID-LAYER, PERFECT FOR RIDING

S-3XL

- 280g of breathable fleece for added warmth
- Offers durable protection against the elements with a wear-resistant polyester face and wind-block layer on chest
- Designed to fit under outer shell when riding



BLACK
2862569

WORK VEST

RUGGED & DURABLE VEST THAT'S IDEAL AS AN OUTDOOR LAYER S-3XL

- Made of durable nylon fabric to make it the ideal vest for work
- 80g 3M™ Thinsulate™ Insulation provides great warmth
- Vest comes with plenty of pockets to store your valuables



BLUE/GRAY
2864521

RED
2833030

BLACK/GRAY
2862565

CAMO
2862572

REVOLVE VEST

REVERSIBLE

DURABLE & WARM REVERSIBLE VEST OFFERS TWO STYLES IN ONE S-3XL

- Durable windbreak outer fabric helps protect from the elements
- 140g 3M™ Thinsulate™ insulation keeps you warm in cold weather



LIGHT GRAY
2833110

GRAY
2862521

NAVY
2862523

ADAPT QUARTER-ZIP

EXTRA LIGHT MID-LAYER WITH A COMFORTABLE FIT S-3XL

- Versatile use both on and off the trail
- The polyester and spandex blend enables a flexible fit



CYPRESS
2864523

DARK BLUE
2864522

ORANGE
2833025

GRAY
2862576

BLUE
2861443

TECH QUARTER-ZIP

FLEECE LINED MID-LAYER FOR ESSENTIAL WARMTH WHILE RIDING WITH THE STYLE & COMFORT TO WEAR ANYWHERE S-3XL

- Fleece-lining keeps you cozy and warm
- Move freely with four-way stretch material
- Contoured, slim fit

> MEN'S APPAREL



UPF HOODIE TEE

Blue | S-3XL | 2833072
Gray | S-3XL | 2833073

ASCENT HOODIE

Black | S-3XL | 2864677
Gray | S-3XL | 2864678
Red | S-3XL | 2864679



CREW SWEATSHIRT

Green | S-3XL | 2864632
Navy | S-3XL | 2864633
Gray | S-3XL | 2833067
Black | S-3XL | 2862488



JOURNEY HOODIE

Red | S-3XL | 2864535
Cypress | S-3XL | 2864536
Black | S-3XL | 2862489



STAPLE HOODIE

Blue | S-3XL | 2864605
Black | S-3XL | 2833068
Green | S-3XL | 2833070



TECH FULL-ZIP HOODIE

Blue | S-3XL | 2864531
Gray | S-3XL | 2861493



ROGUE HOODIE

Blue | S-3XL | 2864587
Black | S-3XL | 2833062
Navy | S-3XL | 2833063



PLAID FLANNEL SHIRT

Blue | S-3XL | 2864671
Cypress | S-3XL | 2864672



BACK

ADVENTURE LONG SLEEVE

Gray | S-3XL | 2833089
Black | S-3XL | 2833090



ICON EDGE LONG SLEEVE

Gray | S-3XL | 2864682
Blue | S-3XL | 2864683



BACK

PERFORMANCE LONG SLEEVE

Gray/White | S-3XL | 2833324
Red | S-3XL | 2864600
Royal Blue | S-3XL | 2833325
Gray | S-3XL | 2833168
Black | S-3XL | 2862507



ICON LONG SLEEVE

Blue | S-3XL | 2864591
Navy | S-3XL | 2864590
Lime | S-3XL | 2833083
Black | S-3XL | 2861584



BACK

GRAPHIC TEE

Heather Gray | S-3XL | 2864612
Dark Gray | S-3XL | 2833086
Forest Green | S-3XL | 2833087



FLAG TEE

Navy | S-3XL | 2862500
White | S-3XL | 2862582



HALF DOME TEE

Black | S-3XL | 2864616
Olive | S-3XL | 2864617
Navy | S-3XL | 2864618



PEAK GRAPHIC TEE

Blue | S-3XL | 2864684
Black | S-3XL | 2864685



ASCENT TEE

Olive | S-3XL | 2864680
Navy | S-3XL | 2864681

> BALL CAPS



HALF DOME PATCH CAP

Black | 2864576
Tan | 2864577



METAL BADGE PANEL CAP

Cypress | 2864574
Black | 2864575



HEX PATCH COOLING CAP

Black | 2864571
Blue | 2864572
Gray | 2864573



ELLIPSE PATCH TRUCKER HAT

Purple | 2864563
Cypress | 2864562
Gray | 2833498
Black | 2833500
Navy | 2833499
Orange | 2833124



STAPLE CAP

Cypress | 2864568
Black | 2833127
Navy | 2833128



TONAL HAT

Orange | 2864564
Black/Red | 2833497
Navy | 2833496



JOURNEY CAP

Light Blue | 2864570
Black | 2833136
Blue | 2833137



LEATHER PATCH HAT

Cypress | 2864569
Black | 2833129
Gray | 2833130



HIGHLAND CAP

Red | 2864567
Navy | 2833126
Gray | 2833506

> BEANIES

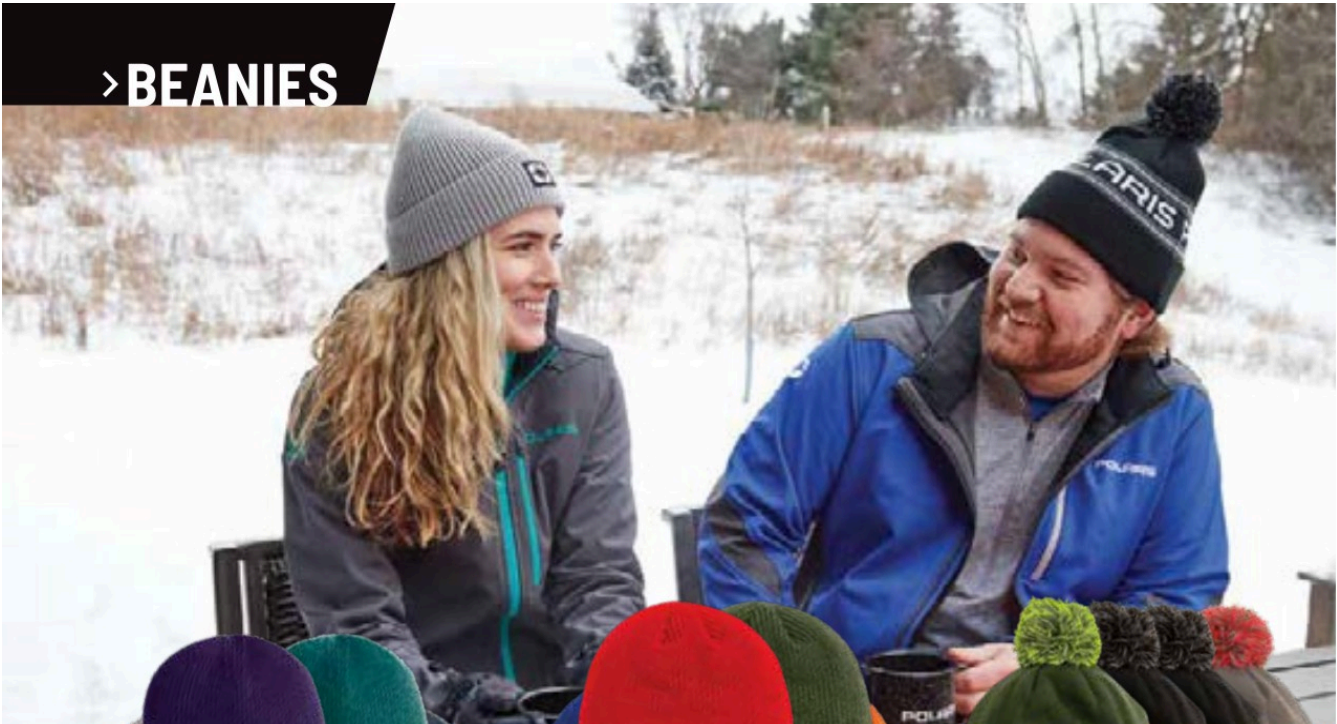

STAPLE BEANIE

Purple | 2864693 Gray | 2833122
 Radiant Green | 2833121 Black | 2833116
 Navy | 2833117

CORE BEANIE

Red | 2864695 Blue | 2833114
 Olive | 2864696 Black | 2862530
 Orange | 2862595

SWITCHBACK BEANIE

Olive | 2864694 Black | 2862532
 Blue | 2833115 Gray | 2862533



LOOSE FIT BEANIE

Olive | 2864708
 Fuchsia | 2864709
 Black/White | 2864710



MARLED CUFF BEANIE

Pink | 2864707
 Gray | 2864706



FAIR ISLE POM BEANIE

White | 2864701
 Teal | 2864702



SPACE DYE POM BEANIE

Blue | 2864703
 Pink | 2864704



FAIR ISLE TASSEL BEANIE

Black/White | 2864711



REMOVABLE POM BEANIE

Red | 2864705
 Black | 2833119
 Green | 2861513
 Gray | 2861514

APPAREL

RACING COLLECTION

JERSEYS & GLOVES
& POLARIS RACING

HELMETS & GOGGLES

RZR APPAREL
& MERCH

MEN'S APPAREL

BALL CAPS & BEANIES

WOMEN'S APPAREL

HOME & COLLECTIBLES

> WOMEN'S APPAREL



BLUE/GRAY
2864519

BLACK
2833041

RADIANT GREEN
2833040

SOFTSHELL JACKET

VERSATILE LIGHTWEIGHT JACKET THAT'S PERFECT FOR EVERYDAY WEAR

S-3XL

- Casual jacket armed with rugged and warm features for everyday wear
- Superior DWR prevents precipitation from saturating the jacket's exterior
- Lined with 280g of soft fleece for warmth
- Removable hood and underarm venting, three external pockets and one internal chest pocket



BLACK
2861433

DEEP LAGOON
2864520

FORCE PUFFER JACKET

PACKABLE JACKET OFFERS LIGHTWEIGHT PROTECTION & INCREDIBLE WARMTH

S-3XL

- 140g 3M[®] Thinsulate[™]
- Two external hand pockets and one internal media pocket
- Rugged YKK[®] zippers
- Compactable into travel pocket



BLACK
2862563

BLUE
2862564

WORK JACKET

WARM AND RUGGED JACKET THAT'S TOUGH FOR WORK & STYLISH FOR PLAY

S-3XL

- 100% nylon shell is coated with Durable Water Repellency to help keep you dry
- Built-in action back for increased range of motion
- 80g 3M[®] Thinsulate[™] for added warmth with brushed flannel trim
- One inner and four outer pockets for storage



BLUE
2864530

RADIANT GREEN
2833042

BLACK/GRAY
2862458

TITAN MID-LAYER

VERSATILE MID-LAYER CAN BE WORN ALONE OR AS AN EXTRA LAYER

S-3XL

- 319g Polartec[®] Thermal Pro[®] Rib Sweater provides great warmth
- Breathable material moves sweat to the outer surface
- Nylon overlay is comfortable and light



PLAID FLANNEL SHIRT

Blue | S-3XL | 2864673
Teal | S-3XL | 2864674



STAPLE HOODIE

Blue | S-3XL | 2864607
Deep Lagoon | S-3XL | 2864608
Gray | S-3XL | 2833096
Black | S-3XL | 2833095



JOURNEY HOODIE

Purple | S-3XL | 2864537
Radiant Green | S-3XL | 2833098
Black | S-3XL | 2862515



CORE TANK

Black | S-3XL | 2833161
Gray | S-3XL | 2833160



FLAG TEE

Gray | S-3XL | 2833163
White | S-3XL | 2833162



ADVENTURE TEE

Heather Gray | S-3XL | 2864604
Blue | S-3XL | 2864603
Pink | S-3XL | 2833104
Teal | S-3XL | 2862629



BACK

ADVENTURE LONG SLEEVE

White | S-3XL | 2864611
Gray | S-3XL | 2833107
Navy | S-3XL | 2833108



UPF POLARIS HOODIE TEE

Pink | S-3XL | 2833102
Teal | S-3XL | 2833103



ADVENTURE CREW

Misty Blue | S-2XL | 2864602
Black/Radiant Green | S-2XL | 2833100
Green | S-2XL | 2833101
Dusty Rose | S-2XL | 2862513

> HOME & COLLECTIBLES



POLARIS KEY RACK
30.5 cm x 20 cm | 2864718



POLARIS LED SIGN
61 cm x 26.7 cm | 2862736



ALUMINUM SIGN
55.9 cm | 2860867



WOOD SIGN
61 cm x 26.7 cm | 2860866



POLARIS STEEL SIGN
91.4 cm x 35.6 cm | 2860868



NEW
RZR PARKING SIGN
2869932

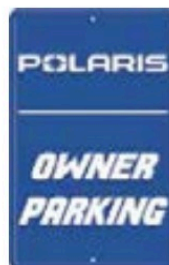

POLARIS PARKING SIGN
2869934



POLARIS FLAG
152 cm x 91.4 cm | 2869928



RZR FLAG
152 cm x 91.4 cm | 2862684



12 OZ CAMPER MUG*
2861612



23 OZ WATER BOTTLE*
2862685



15 OZ CAMPFIRE MUG*
2861613



POLARIS PVC COASTERS
2864715



POLARIS LOWBALL GLASSES WITH COASTERS (SET OF 2)
2864721



FLASK*
2860812



PREMIUM KOOZIE*
2860829



KICKBACK ROCKER*
NEW Green | 2864816
Blue | 2862626



FREESTYLE ROCKER*
2862625



EASY CHAIR*
2862627



NEW PICO CHAIR*
2864817



QUICK-E-SEAT*
2862624



FOLDABLE TABLE
2861620



NEW RZR STICKER 6"
15.24 cm x 4.45 cm | 2861865



KEY CHAINS

PVC Keychain | 2861614
Leather Loop | 2861615
Black Leather | 2861616



DECK OF CARDS
2860816



POLARIS NOTEBOOK
2860831



HITCH COVER
2861623



LICENSE PLATE HOLDER
2862687

*Not available in Europe



MAKE IT YOUR RZR

DUNES

LIGHTING	P. 80
STORAGE	P. 34
PRO ARMOR WHEELS & TIRES	P. 88
ROOFS	P. 28
DOORS	P. 29

MUD

PRO ARMOR WHEELS & TIRES	P. 88
WINCHES	P. 57
DOORS	P. 49
ROOFS	P. 48
LIGHTING	P. 84
AUDIO	P. 44
STORAGE / COOLERS	P. 54



ROCK

PRO ARMOR WHEELS & TIRES	P. 88
VEHICLE PROTECTION	P. 30
WINCHES	P. 37
ROOFS	P. 28
STORAGE	P. 34

Availability varies by market, check your local dealer for availability. Images taken on private land. The use of vehicles in similar environments in your jurisdiction may be prohibited per locally applicable laws and regulations. Campfires in similar environments in your jurisdiction may be prohibited per locally applicable laws and regulations. Keep your campfire safe, and make sure you can control it at all times. Know your locally applicable laws and regulations. Crossing water in similar environments may be prohibited in your jurisdiction.

Warning: Polaris off road vehicles can be hazardous to operate and are not intended for on-road use. Driver must be at least 16 years old with a valid driver's license to operate. All riders should always wear helmets, eye protection and protective clothing and footwear. Read, understand and follow your owner's manual. Ride within the limits of your own abilities and never engage in stunt or exhibition driving. Never ride under the influence of drugs or alcohol. All riders should take a safety training course.

UNLESS NOTED, TRADEMARKS ARE THE PROPERTY OF POLARIS INDUSTRIES INC. 3M® and Thinsulate® are registered trademarks of 3M Company. 509® is a registered trademark of Teton Outfitters, LLC. App Store® is a registered trademark of Apple Inc. Bluetooth® is a registered trademark of Bluetooth Sig, Inc. Caliber® is a registered trademark of Caliber Products Inc. Facebook™ is a service trademark of Facebook, Inc. FOX® is a registered trademark of Fox Factory Inc. Fidlock® is a registered trademark of Fidlock GmbH. Google Play™ is a registered servicemark of GOOGLE LLC. GoPro® is a registered trademark of GoPro Inc. High Lifter® is a registered trademark of NIVEL PARTS & MANUFACTURING CO., LLC. Instagram™ is a service trademark of Instagram, LLC. KING OF THE HAMMERS® is a registered trademark of Hammering Productions, Inc. KLIM® is a registered trademark of Teton Outfitters, LLC. MB Quart® is a registered trademark of Maxxsonics LLC. MORFLEX® is a registered trademark of FNA Group, Inc. NOCO Genius® is a registered trademark of The Noco Company. Pandora® is a registered trademark of Pandora Media, LLC. Polartec® and Thermal Pro® are registered trademarks of MMI-IPCO, LLC. Proline Wraps® is a registered trademark of Andrew Madrid. RIGID® is a trademark of JST Performance, LLC d/b/a Rigid Industries LLC. Rockford Fosgate® is a registered trademark of Rockford Corporation. S&B® is a registered trademark of S&B Filters, Inc. SMART BOARD® is a registered trademark of SMART TECHNOLOGIES ULC UNLIMITED LIABILITY CORPORATION CANADA. Sparco® is a registered trademark of Sparco S.P.A. TEKVEST® is a registered trademark of 1181676 ONTARIO INC. The Mint 400® is a registered trademark of THE MINT 400 CORPORATION. Tiger Drylac® is a registered trademark of TIGER COATINGS GMBH & CO. Twitter™ is a service trademark of Twitter, Inc. Velcro® is a registered trademark of VELCRO IP HOLDINGS LLC. WALKER EVANS RACING® is a registered trademark of Walker Evans Enterprises Incorporated. YKK® is a registered trademark of YKK Corporation. YouTube® is a registered trademark of GOOGLE LLC. Fitment and availability are subject to change. COPYRIGHT © 2023 POLARIS INDUSTRIES INC. ALL RIGHTS RESERVED.

RIDE OF YOUR LIFE



POLARIS
Think Outside

MY24 RZR APP ACC EMEA