

POLARIS SPORTSMAN



2024

**ACCESSORIES,
MAINTENANCE & APPAREL**

EMEA VERSION



FORGE YOUR OWN PATH

The ATV that defined the industry, Sportsman combines legendary smoothness, unstoppable versatility and an ease of use that the competition continues to chase, which is why Sportsman is chosen by more ATV owners. Whether you're tearing up the trails, working out in the fields, or navigating the wilderness for the perfect hunt, there is a Sportsman story to be told.



POLARIS SPORTSMAN

10 570

- 12 WINCHES, RACKS & PROTECTION
- 14 COMFORT, AUDIO & STORAGE
- 16 WINDSHIELDS
- 18 570 X2, 570 6x6 & 570 TOURING

20 XP 1000 / XP 1000 S

- 22 WINCHES, RACKS & PROTECTION
- 24 STORAGE, AUDIO & COMFORT
- 26 WINDSHIELDS

28 SCRAMBLER XP 1000 S

30 MISCELLANEOUS & YOUTH

32 COMMON ACCESSORIES

- 32 WINCHES
- 34 PLOWS
- 36 TRACKS
- 38 WHEELS & TIRES
- 46 LIGHTING
- 48 HUNT
- 50 POLARIS NORTHSTAR COOLERS

52 MAINTENANCE & GARAGE

- 54 MAINTENANCE
- 56 OIL & LUBRICANTS
- 58 MAINTENANCE FLUIDS
- 60 HD PARTS
- 62 SERVICE PARTS
- 64 CLEANERS & TRAILERING

66 APPAREL

- 68 RACING COLLECTION
- 70 JERSEYS, GLOVES & HEATED APPAREL
- 72 HELMETS & GOGGLES
- 74 MEN'S APPAREL
- 78 BALL CAPS & BEANIES
- 80 WOMEN'S APPAREL
- 82 HOME & COLLECTIBLES

IMPORTANT: Adding accessories may impact the vehicle's conformity to its homologation or type approval. Polaris recommends consulting with local authorities and/or your local dealer to understand the requirements and restrictions related to the installation of accessories on your vehicle.

DESIGNED by the people who designed your vehicle.



TESTED extensively in the field so you ride with 100% confidence.



WE HOLD OUR PARTNERS TO THE SAME STANDARDS



WHEELS, TIRES & LIGHTING DESIGNED WITH POLARIS TO MAXIMIZE PERFORMANCE

P. 38, 47

KEEP YOUR
STANDARDS HIGH.
WE DO.

TRUSTED

65 years in the business.
The #1 name in off-road.



A GLOBAL LEADER IN AUDIO INNOVATION,
DESIGN & ENGINEERING

P. 15, 25



PRODUCTS SO GOOD THEY REPLACE
OR REPAIR THEM FOR LIFE

P. 46



PROTECTING YOUR
ESSENTIAL GEAR SINCE 1943

P. 48

ENGINEERED FOR MORE

Ensuring Polaris Engineered Accessories fit and work in sync with your machine is the most critical phase of testing and validation. With seamless integration, you can trust that any Polaris accessory you install will enhance your experience beyond your expectations.



CARGO VERSATILITY

Lock & Ride mounting locations allow for limitless customization to let you work the way you want.

P. 15, 24





PRO PRO HEAVY DUTY SERIES

WINCHES

INTEGRATED WINCH MOUNT & PRE-WIRED

Designated mounting points and pre-wired contactors ensure a perfect fit and the strongest place to attach a Polaris Engineered winch - the most dependable winch for your Sportsman. With wiring built right into the vehicle, we made this the easiest winch to install on a Sportsman.

P. 32

GLACIER®

PLOW SYSTEM

INTEGRATED PLOW MOUNT

The attachment points for the Glacier Plow System are integrated right at the factory and feature an innovative drive-up and go installation process.

P. 34



SUPERIOR INTEGRATION

PRO PRO HEAVY DUTY SERIES WINCHES



✓ Pre-wired chassis & no need to cut panels

Factory-installed wiring makes the controls simple to install. Mount the winch, connect the wires and trust that everything is routed safely, securely, and properly.

✓ Tested 1,200+ pulls at max load

✓ Built to withstand -29° C temperatures

✓ Operates fully submerged underwater

✓ Military tested and approved



① Sealed permanent magnet motor

② Cut steel gears and sealed drivetrain

③ PREMIUM SYNTHETIC ROPE

With its lightweight, yet extremely strong, design and superior flexibility, this 15.2 m long synthetic rope is easy to handle and can stand up to any tough job.

④ RAPID ROPE RECOVERY 5X FASTER

Retrieve cable 5x faster than standard mode on other Polaris winches. Get back to riding or complete your task quicker.

⑤ AUTO STOP TECHNOLOGY

Auto Stop technology protects and extends the life of your winch by automatically stopping the winch at the end of pull to prevent over-spooling. While plowing, it prevents the plow frame from bending by stopping the winch once the plow has been lifted.

✓ WIRELESS REMOTE

This convenient remote operates your Polaris winch wirelessly from within 15.2 m of the vehicle. Operate your winch safely outside your vehicle while on the job site or trails.

LEARN MORE ABOUT POLARIS ENGINEERED WINCHES

P. 32

Right from the factory, your vehicle is built to make essential accessories like winches and plows easy to use day-in and day-out. Mounting brackets are designed into the oversized factory bumper and wiring is routed securely and properly. When it comes to Sportsman, Polaris Engineered Accessories make work easier so you can get more done.

GLACIER[®] PLOW SYSTEM



- ✓ Easily install and remove the plow system from your Sportsman
- ✓ No loss of factory ground clearance when not plowing
- ✓ Don't have to crawl under the machine to release the plow blade from the vehicle
- ✓ No trimming of vehicle plastic required to mount plow or winch
- ✓ Angle your blade right from your seat with the Glacier Pro Plow Hydraulic Angle System
- ✓ 30 seconds: Drive up, clip in, lock down, and go

LEARN MORE ABOUT
THE GLACIER PLOW SYSTEM
P. 34



DRIVE UP



CLIP IN



LOCK DOWN

SPORTSMAN 570



COMFORT ESSENTIALS

Polaris PRO HD 1,588 kg Winch with Rapid Rope Recovery P. 12

Rear Rack Extender P. 13

Trail Brushguard P. 13

Rear Brushguard P. 13

Handguards P. 14

Handguard Mounts P. 14

LED Light Kit P. 14

Rear Power Harness P. 14

Audio Storage Box Remote P. 15

LR LOCK RIDE Rear Audio Storage Box P. 15

Pod Bag P. 15

Fender Bag P. 15

Pro Armor Wheel & Tire Set: Dual Threat/4202 P. 45

Lug Nuts P. 45

RIGID D-Series Pod Light P. 46

Lightbar Harness P. 47

LED Y-Harness P. 47



HUNTER

Polaris PRO HD 1,588 kg Winch with Rapid Rope Recovery P. 12

Rear Rack Extender P. 13

HD Front Brushguard with Hitch P. 13

Hand & Thumb Warmer Kit P. 14

LR LOCK RIDE Mid 39.4 cm Clear Windshield P. 16

Pro Armor Wheel & Tire Set: Attack 2.0/4205 P. 45

Lug Nuts P. 45

RIGID SR-Series 25.4 cm Combo LED Light P. 47

Lightbar Harness P. 47

Kolpin Stronghold Gun Boot L P. 48

Kolpin Stronghold Auto-Latch Mount P. 48

LR LOCK RIDE MAX Rhino Grip Pro P. 49



WORKER

Polaris HD 1,134 kg Winch P. 12

Front Utility Rack P. 13

Rear Rack Extender P. 13

Rear Brushguard P. 13

HD Front Brushguard with Hitch P. 13

Body Armor P. 13

Rear Power Harness P. 14

LOCK & RIDE Open Cargo Box P. 15

LOCK & RIDE Mid 39.4 cm Clear Windshield P. 16

Pro Armor Wheel & Tire Set: Harvester/4204 P. 45

Lug Nuts P. 45



WINTER

Polaris PRO HD 1,588 kg Winch with Rapid Rope Recovery P. 12

Rear Rack Extender P. 13

HD Front Brushguard with Hitch P. 13

Hand & Thumb Warmer Kit P. 14

LOCK & RIDE Rear Cargo Box P. 15

LOCK & RIDE Tall 48.9 cm Clear Windshield P. 16

Glacier Integrated Plow Mount P. 35

Glacier Pro Lock & Ride Steel ATV Plow Frame, Black P. 35

Glacier Pro Plow Blade - 167.6 cm Poly P. 35

RIGID SR-Series 25.4 cm Combo LED Light P. 47

Lightbar Harness P. 47

SPORTSMAN 570



NEED A PLOW? P. 34

WINCHES



POLARIS PRO HD 1,588 kg WINCH

- Adds 1,588 kg of pulling capacity with Auto Stop Technology for plowing applications
- Rapid Rope Recovery recovers open cable 5x as fast as standard mode on other Polaris winches

» 2884834

SPORTSMAN 450/570 '21-24



POLARIS HD 1,588 kg WINCH

- Adds 1,588 kg of pulling capacity with quick and easy installation
- Includes all components required for installation plus 15 m of .5 cm premium high-strength synthetic rope

» 2884833

SPORTSMAN 450/570 '21-24



POLARIS HD 1,134 kg WINCH

TOP SELLER

- Adds 1,134 kg of pulling capacity with quick and easy installation
- Includes all components required for installation plus 15 m of .5 cm high-strength steel cable

» 2884832

SPORTSMAN 450/570 '21-24



LEARN MORE P. 32

RACKS



FRONT UTILITY RACK TOP SELLER

- Tubular steel rack that attaches on top of front plastic rack providing protection and multiple tie down points
- 1.9 cm diameter matte black steel tube

» 2884842

SPORTSMAN 450/570 '21-24, EXCEPT '21 AND PRIOR 6X6, X2 AND TOUR MODELS
DOES NOT WORK WITH KOLPIN STRONGHOLD AUTO-LATCH GUN MOUNT (2884846)



REAR UTILITY RACK TOP SELLER

- Replaces rear plastic rack with a strong flat steel rack with integrated tie down points
- Works with all Lock & Ride accessories, rack extenders, and gun mounts

» 2884843

SPORTSMAN 450/570 '21-24



CARGO RACK

- Provides extra storage and a sturdy platform for securing items to the back of your ATV
- Replaces your stock rear bumper while increasing your rack size by 33%
- Virtually limitless number of tie-down points
- Has a steel matte black finish

» 2890037

SPORTSMAN 450/570 '21-24
WILL NOT WORK WITH REAR BUMPER: SERVES AS REAR BUMPER / REAR CARGO RACK



REAR RACK EXTENDER TOP SELLER

- Forms a 7.6 cm tall perimeter around the rear cargo rack to keep gear secure which maximizes your cargo capabilities
- Durable steel construction provides a sturdy tie down anchor for loose gear
- Compatible with Cargo Boxes and Rear Utility Rack

» 2884841

SPORTSMAN 450/570 '21-24

PROTECTION



TRAIL BRUSHGUARD TOP SELLER

- Provides enhanced protection from brush and debris
- Has designated light bar holes and is compatible with winch and Body Armor

» 2884844

SPORTSMAN 450/570 '21-24



REAR BRUSHGUARD TOP SELLER

- Protect your vehicle from brush, sticks, rocks and light bumps into solid objects
- Made of sturdy 3.2 cm steel tube with a matte black finish

» 2884847

SPORTSMAN 450/570 '21-24
5270585-458 NEEDED TO MOUNT REAR LICENSE PLATE



HD FRONT BRUSHGUARD WITH HITCH

- Adds heavy-duty protection with a custom look
- Has designated light bar holes and is compatible with winch and Body Armor
- Standard front receiver hitch for additional functionality

» 2884850

SPORTSMAN 450/570 '21-24



BOOT GUARDS

- Made from High Density Poly Ethylene (HDPE)
- Comes with two front guards, one for the left and right
- Protects the CV boot

» 2890059

SPORTSMAN 450/570 '21-24



BODY ARMOR

- Provides extra protection to your ATV's full body and fenders

» 2884851

SPORTSMAN 450/570 '21-24
FRONT BUMPER (2884850 OR 2884844) REQUIRED FOR INSTALLATION
DOES NOT WORK WITH KOLPIN STRONGHOLD AUTO-LATCH GUN MOUNT (2884846)



SKID PLATE

- Built to be tough from 10mm thick High Density Poly Ethylene (HDPE)

» 2884852

SPORTSMAN 450/570 '21-24

SPORTSMAN 570



COMFORT



HANDGUARDS

- Handguard Mount (2889341) is required when installing Polaris Handguards
- Does not fit with windshields or Handlebar Mounted Mirrors

<input type="checkbox"/>	BRIGHT WHITE	2876883
<input checked="" type="checkbox"/>	BLACK <small>TOP SELLER</small>	2876846
<input type="checkbox"/>	INDY RED	2876845

» MOUNT • 2889341
SPORTSMAN 450/570 '21-24



LED LIGHT KIT

- Upgrade your standard headlights and pod lights to LEDs with this upgrade kit

» 2884859
SPORTSMAN 450/570 '21-24
U.S. MODELS ONLY



HAND & THUMB WARMER KIT TOP SELLER

- Provides heat to grips and throttle and is easily installed by plugging into pod
- Includes two heated grips and one throttle warmer

» 2885002
SPORTSMAN 450/570 '21-24



NEW LATE AVAILABILITY ULTIMATE SERIES HANDGUARD KIT

- Protects riders from wind, snow, ice, branches, and other trail debris
- Larger design offers increased level of warmth and protection

• Ultimate Series Handguard Kit includes mounts
» 2890579-266
SPORTSMAN 450/570 '21-24
NOT COMPATIBLE WITH WINDSHIELDS OR
HANDLEBAR MOUNTED MIRRORS



HANDLEBAR MOUNTED MIRRORS TOP SELLER

- Enhances visibility of what's behind you for added safety
- Sold as a pair
- Does not fit with windshields or Handguards

» 2877222
SPORTSMAN 450/570 '21-24



REAR POWER HARNESS

- Provides power to the rear of the ATV for electrical accessories including Rear Audio Storage Box

» 2889070
SPORTSMAN 450/570 '21-24

AUDIO



AUDIO STORAGE BOX REMOTE

- Easily control the volume or switch to the next song on your Rear Audio Storage Box
- Conveniently mounts to your ATV's handlebars

» 2884987

SPORTSMAN 450/570 '21-24



LOCK & RIDE REAR AUDIO STORAGE BOX

- Dual 15.2 cm speakers by Rockford Fosgate that connect via Bluetooth
- Mounts easily with Lock & Ride to the rear rack and is compatible with rack extenders, utility rack, and gun mount
- Rest easy knowing that your speakers are protected with a sealed-lid container
- Rear Power Harness required for installation (2889070)

» 2884856

SPORTSMAN 450/570 '21-24

STORAGE



POD BAG

- Keep your essentials in reach with 2 Liters of storage capacity
- Mounts to the top of the light pod with HD Velcro
- Semi-rigid construction and PU Laminated EVA material keeps belongings protected from the elements
- Compatible with windshields

» 2889286

SPORTSMAN 450/570 '21-24



FENDER BAG

- Provides easy-access 8.3 Liters of storage
- Mounts to the front left fender with HD Velcro
- Semi-rigid construction and PU Laminated EVA material keeps belongings protected from the elements

» 2889287

SPORTSMAN 450/570 '21-24



REAR RACK EXTENDER BAGS

- Three bags included (Rear Rack Extender sold separately)
- Mounts to Rear Rack Extender with HD Velcro
- Add a convenient 1 Liter of storage without sacrificing the rear rack
- Made to withstand the elements and wear with durable ballistic nylon construction (1680 Nylon and 600D SPD)
- Rear Rack Extender (2884841) is required

» 2889411

SPORTSMAN 450/570 '21-24

UNDERSEAT BAG

- Provides an extra 8.3 Liters of storage capacity
- Mounts directly under your seat via a Velcro wrap
- Durable semi-rigid construction keeps items protected

» 2889454

SPORTSMAN 450/570 '21-24



LOCK & RIDE REAR CARGO BOX TOP SELLER

- Increase your storage with an extra 80.4 liters of dry, dust-proof storage
- Mounts easily with Lock & Ride to the rear rack and is compatible with rack extenders, utility rack, and gun mount
- Includes 2 padlock locations

» 2884853

SPORTSMAN 450/570 '21-24



LOCK & RIDE OPEN CARGO BOX

- Increase your storage with an extra 83.3 liters of convenient storage space
- Mounts easily with Lock & Ride to the rear rack and is compatible with rack extenders, utility rack, and gun mount
- Holds two 18.9-liter buckets with integrated grab handle to make it easy to carry and transport cargo
- 12 convenient tie-down locations to secure cargo

» 2884854

SPORTSMAN 450/570 '21-24



LOCK & RIDE REAR COOLER BOX

- Increase your storage with an extra 46 quarts of weather resistant cooler storage
- Mounts easily with Lock & Ride to the rear rack and is compatible with rack extenders, utility rack, and gun mount
- Integrated bottle opener and 2 padlock locations

» 2884857

SPORTSMAN 450/570 '21-24

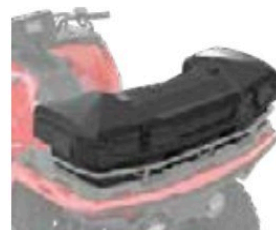

SPORTSMAN 570



WINDSHIELDS



TOP SELLER
TALL 48.9 cm CLEAR
2884945



TOP SELLER
MID 39.4 cm CLEAR
2884845



SMALL 24.1 cm CLEAR
2884946

LR LOCK & RIDE WINDSHIELDS

- Lock & Ride technology allows for easy installation and removal in seconds without tools
- Poly windshields are flexible, impact-resistant, and provide long-term value over the life of your machine
- Two heights available for whatever coverage you prefer

SIZE	COLOR	PART #
TALL 48.9 cm	CLEAR	2884945
MID 39.4 cm	CLEAR	2884845
SMALL 24.1 cm	CLEAR	2884946

SPORTSMAN 450/570 '21-24





DO MORE

ACCESSORIES

570

XP 1000 / XP 1000 S

SCRAMBLER XP 1000 S

MISCELLANEOUS & YOUTH

WINCHES, PLOWS & TRACKS

WHEELS & TIRES

LIGHTING

HUNT & COOLERS



PLOWS P. 34



WHEELS & TIRES P. 38



LIGHTING P. 46



HUNT P. 48

SPORTSMAN

2014-2023

570 X2

2014-2023

570 6X6

570 TOURING



WINCHES

POLARIS HD 1,588 kg WINCH

» 2880434

X2 570 '15-23, TOURING 570 '14-23, 6X6 570 '17-23



POLARIS HD 1,134 kg WINCH

TOP SELLER

» 2880432

X2 570 '15-23, TOURING 570 '14-23, 6X6 570 '17-23



NEED A PLOW? SEE P. 34

STORAGE & RACKS



SEMI-RIGID TOURING CARGO BAG

- Large-capacity, heavy-duty vinyl bag
- Three zippered openings, removable dividers
- Attaches to rack with Velcro straps

» 2877220

TOURING 570 '14-23



ULTIMATE SERIES FRONT RACK EXTENDER 10.2 cm

TOP SELLER

» 2879716

X2 570 '15-23, TOURING 570 '14-23, 6X6 570 '17-23



LOCK RIBBE YUKON ADVENTURE RACK

- Adds increased storage volume by allowing you to increase storage height securely

» 2882084

6X6 570 '17-23

COMFORT



NEW LATE AVAILABILITY

ULTIMATE SERIES HANDGUARD KIT

- Protects riders from wind, snow, ice, branches, and other trail debris
- Larger design offers increased level of warmth and protection
- Ultimate Series Handguard Kit includes mounts

» 2890579-266

X2 570 15-23, TOURING 570 14-23, 6X6 570 17-23

NOT COMPATIBLE WITH WINDSHIELDS OR HANDLEBAR MOUNTED MIRRORS



HANDGUARDS

- Handguard Mount (2889341) is required when installing Polaris Handguards
- Does not fit with Windshields or Handlebar Mounted Mirrors

<input type="checkbox"/>	BRIGHT WHITE	2876883
<input checked="" type="checkbox"/>	BLACK TOP SELLER	2876846
<input type="checkbox"/>	INDY RED	2876845

» 2889341 - MOUNT

X2 570 15-23, TOURING 570 14-23, 6X6 570 17-23



HAND & THUMB WARMER KIT **TOP SELLER**

- Provides heat to grips and throttle and is easily installed by plugging into pod
- Includes two heated grips and one throttle warmer

» 2885002

X2 570 15-23, TOURING 570 14-23, 6X6 570 17-23

REQUIRES HAND & THUMB WARMER JUMPER HARNESS (2890685), SOLD SEPARATELY, FOR SELECT VEHICLES



NEW

HAND & THUMB WARMER JUMPER HARNESS

- Required for Hand & Thumb Warmer Kit installation on select vehicles

» 2890685

X2 570 15-23, TOURING 570 14-23, 6X6 570 17-23



HANDLEBAR MOUNTED MIRRORS **TOP SELLER**

- Enhances visibility of what's behind you for added safety
- Sold as a pair
- Does not fit with Windshield Fairing or Handguards

» 2877222

X2 570 15-23, TOURING 570 14-23, 6X6 570 17-23

PROTECTION



FRONT BRUSHGUARD **TOP SELLER**

» 2879714

X2 570 15-23, TOURING 570 14-23, 6X6 570 17-23



REAR BRUSHGUARD

» 2879715

TOURING 570 14-23

WINDSHIELDS

LR LOCK-RIDE WINDSHIELDS

- Lock & Ride technology allows for easy installation and removal in seconds without tools
- Poly windshields are flexible, impact-resistant, and provide long-term value over the life of your machine
- Does not work with Handguards

SIZE	COLOR	PART #
TALL 48.9 cm	CLEAR	2880539-409
MID 39.4 cm	SMOKE	2880540-412

X2 570 18-23, TOURING 570 18-23



TALL 48.9 cm CLEAR



MID 39.4 cm SMOKE

SPORTSMAN

XP 1000 XP 1000 S



COMFORT ESSENTIALS

Polaris Pro HD 1,588 kg Winch P. 22

Ultimate Series Rear Rack Extender P. 23

Ultimate Series Front Brushguard P. 23

Ultimate Series Rear Brushguard P. 23

Pod Bag P. 24

Audio Storage Box Remote P. 25

LR LOCK RIDE Rear Audio Storage Box P. 25

Handguards P. 25

Handguard Mount P. 25

Rear Power Harness P. 25

Pro Armor Wheel & Tire Set: Dual Threat/4202 P. 45

Lug Nuts P. 45

RIGID D-Series Pod Light P. 46

Lightbar Harness P. 47

LED Y-Harness P. 47



HUNTER

Polaris HD 1,588 kg Winch P. 22

Ultimate Series Rear Rack Extender P. 23

Ultimate Series Front Brushguard P. 23

Hand & Thumb Warmer Kit P. 25

LR LOCK RIDE Mid 39.4 cm Clear Windshield P. 26

Pro Armor Wheel & Tire Set: Attack/4205 P. 45

Lug Nuts P. 45

RIGID SR-Series 25.4 cm Combo LED Light P. 47

Lightbar Harness P. 47

Kolpin Stronghold Gun Boot L P. 48

Kolpin Stronghold Auto-Latch Mount P. 48

LR LOCK RIDE MAX Rhino Grip Pro P. 49



WORKER

Polaris HD 1,134 kg Winch P. 22

Ultimate Series Rear Rack Extender P. 23

Ultimate Series Front Steel Rack P. 23

Ultimate Series Front Brushguard P. 23

Ultimate Series Rear Brushguard P. 23

Ultimate Series Body Armor P. 23

LR LOCK-TRIBE Open Cargo Box P. 24

Rear Power Harness P. 25

LR LOCK-TRIBE Mid 39.4 cm Clear Windshield P. 26

Pro Armor Wheel & Tire Set: Harvester/4204 P. 45

Lug Nuts P. 45



WINTER

Polaris Pro HD 1,588 kg Winch P. 22

Ultimate Series Rear Rack Extender P. 23

Ultimate Series Front Brushguard P. 23

LR LOCK-TRIBE Rear Cargo Box P. 24

Hand & Thumb Warmer Kit P. 25

LR LOCK-TRIBE Tall 48.9 cm Clear Windshield P. 26

Glacier Integrated Plow Mount P. 35

Glacier Pro Steel ATV Plow Frame P. 35

Glacier Pro Plow Blade - 167.6 cm Poly P. 35

RIGID SR-Series 25.4 cm Combo LED Light P. 47

Lightbar Harness P. 47

SPORTSMAN

XP 1000 XP 1000 S



NEED A PLOW? P. 34

WINCHES



POLARIS PRO HD 1,588 kg WINCH

TOP SELLER

» 2889471

SPORTSMAN 850 '12-24, SPORTSMAN XP 1000 '15-24,
SPORTSMAN TOURING XP 1000 '15-24,
SPORTSMAN TOURING 850 '15-24



» 2883580

SPORTSMAN XP 1000 S '20-24



POLARIS HD 1,588 kg WINCH

» 2889470

SPORTSMAN 850 '12-24, SPORTSMAN XP 1000 '15-24,
SPORTSMAN TOURING XP 1000 '15-24,
SPORTSMAN TOURING 850 '15-24



POLARIS HD 1,134 kg WINCH

» 2889469

SPORTSMAN 850 '12-24, SPORTSMAN XP 1000 '15-24,
SPORTSMAN TOURING XP 1000 '15-24,
SPORTSMAN TOURING 850 '15-24



LEARN MORE P. 32

RACKS



FRONT



REAR

ULTIMATE SERIES RACK EXTENDER 10.2 cm

» FRONT • 2882022

SPORTSMAN 850/1000 '17-24,
SPORTSMAN XP 1000 S '20-24

» REAR • 2882023

SPORTSMAN 850/1000 '17-24,
SPORTSMAN XP 1000 S '20-24
FITS WITH REAR CARGO BOX (2882882)



FRONT



REAR

ULTIMATE SERIES RACK EXTENDER 17.8 cm

» FRONT • 2882024

SPORTSMAN 850/1000 '17-24,
SPORTSMAN XP 1000 S '20-24

» REAR • 2882025

SPORTSMAN 850/1000 '17-24,
SPORTSMAN XP 1000 S '20-24
DOES NOT FIT WITH REAR CARGO BOX (2882882)



FRONT RACK EXTENDER

» 2879890

SPORTSMAN 850/1000 TOURING '10-24
DOES NOT FIT WITH FRONT CARGO BOX (2877951)



ULTIMATE SERIES MOVEABLE TIE-DOWN POINTS

• Comes as pair

» FRONT & REAR • 2882270

SPORTSMAN 850/1000 '17-24

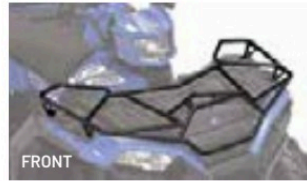

FRONT



REAR

ULTIMATE SERIES STEEL RACK

» FRONT • 2883257

SPORTSMAN 850/1000 '17-24,
SPORTSMAN XP 1000 S '20-24

» REAR • 2883258

SPORTSMAN 850/1000 '17-24,
SPORTSMAN XP 1000 S '20-24

PROTECTION



ULTIMATE SERIES BODY ARMOR

- Securely mounts to Ultimate Series Front Brushguard (2882020)
- Comes as pair

» 2882090

SPORTSMAN 850/1000 '17-24
DOES NOT WORK WITH GUN BOOT MOUNT (2882036)



FRONT



REAR

ULTIMATE SERIES BRUSHGUARD TOP SELLER

- Quick installation to the integrated mounting tubes on the vehicle using wedge-style expansion anchor mounts
- Attach the Ultimate Series Body Armor to the Front Brushguard to provide the ultimate protection for the front fenders

» FRONT • 2882020

SPORTSMAN 850/1000 '17-24,
SPORTSMAN XP 1000 S '20-24

» REAR • 2882583

SPORTSMAN 850/1000 '17-24,
SPORTSMAN XP 1000 S '20-24



FRONT

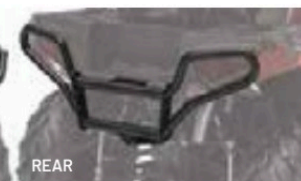

REAR

TOURING XP BRUSHGUARD

- Adds heavy-duty protection and a custom look

» FRONT • 2878709

SPORTSMAN 850/1000 TOURING '10-24

» REAR • 2878324

SPORTSMAN 850/1000 TOURING '10-24

SPORTSMAN

XP 1000 XP 1000 S



STORAGE



LR LOCK & RIDE REAR CARGO BOX TOP SELLER

- Increase your storage with an extra 80.4 liters of dry, dust-proof storage
- Mounts easily with Lock & Ride to the rear rack and is compatible with rack extenders and gun mount
- Includes 2 padlock locations
- Will not fit when Ultimate Series Steel Rack is installed

» 2884853

SPORTSMAN 850/1000 '17-24, SPORTSMAN XP 1000 S '20-24



LR LOCK & RIDE OPEN CARGO BOX

- Increase your storage with an extra 83.3 liters of convenient storage space
- Mounts easily with Lock & Ride to the rear rack and is compatible with rack extenders and gun mount
- Holds 2, 18.9-liter buckets with integrated grab handle to make it easy to carry and transport cargo
- 12 convenient tie-down locations to secure cargo
- Includes 2 padlock locations
- Will not fit when Ultimate Series Steel Rack is installed

» 2884854

SPORTSMAN 850/1000 '17-24, SPORTSMAN XP 1000 S '20-24



LR LOCK & RIDE REAR COOLER BOX

- Increase your storage with an extra 46 quarts of weather-resistant cooler storage space
- Mounts easily with Lock & Ride to the rear rack and is compatible with rack extenders and gun mount
- Integrated bottle opener and 2 padlock locations
- Will not fit when Ultimate Series Steel Rack is installed

» 2884857

SPORTSMAN 850/1000 '17-24, SPORTSMAN XP 1000 S '20-24



POD BAG

- Keep your essentials in reach with 2 liters of storage capacity
- Mounts to the top of the light pod with HD Velcro
- Semi-rigid construction and PU Laminated EVA material keeps belongings protected from the elements
- Compatible with windshields

» 2889286

SPORTSMAN 850/1000 '21-24



ULTIMATE SERIES READY PACK

- Keep your trail essentials at the ready with this easy-to-access, weather-resistant storage compartment

» 2882271

SPORTSMAN 850/1000 '17-24



LR LOCK & RIDE FRONT CARGO BOX

» 2877951

SPORTSMAN 850/1000 TOURING '10-24
FRONT RACK EXTENDER CANNOT BE INSTALLED AT THE SAME TIME AS FRONT CARGO BOX



LR LOCK & RIDE REAR STORAGE BOX

» 2878000

SPORTSMAN 850/1000 TOURING '10-24
SLIGHT INTERFERENCE WITH SPORTSMAN TOURING 550/850 '11-14 PASSENGER HANDLES
DOES NOT FIT '21 TOURING MODELS

AUDIO



AUDIO STORAGE BOX REMOTE

- Easily control the volume or switch to the next song on your Rear Audio Storage Box
- Conveniently mounts to your ATV's handlebars

» 2884987

SPORTSMAN 850/1000 '17-24, SPORTSMAN XP 1000 S '20-24



LOCK & RIDE REAR AUDIO STORAGE BOX

- Dual 15.2 cm speakers by Rockford Fosgate that connect via Bluetooth
- Mounts easily with Lock & Ride to the rear rack and is compatible with rack extenders and gun mount
- Rest easy knowing that your speakers are protected with a sealed-lid container
- Rear Power Harness (2889071) is required, sold separately

» 2884856

SPORTSMAN 850/1000 '17-24, SPORTSMAN XP 1000 S '20-24

COMFORT



HANDLEBAR MOUNTED MIRRORS TOP SELLER

- Enhances visibility of what's behind you for added safety
- Sold as a pair
- Does not fit with Windshield Fairing or Handguards

» 2877222

SPORTSMAN 850/1000 TOURING '10-24, SPORTSMAN 850/1000 '09-24, SPORTSMAN XP 1000 S '20-24



HAND & THUMB WARMER KIT TOP SELLER

- Provides heat to grips and throttle and is easily installed by plugging into pod
- Includes two heated grips and one throttle warmer

» 2885002

SPORTSMAN XP 1000 S '20-24, SPORTSMAN 850/1000 '15-24, SPORTSMAN TOURING 850/1000 '15-24
REQUIRES HAND & THUMB WARMER JUMPER HARNESS (2890685), SOLD SEPARATELY, FOR SELECT VEHICLES



NEW LATE AVAILABILITY ULTIMATE SERIES HANDGUARD KIT

- Protects riders from wind, snow, ice, branches, and other trail debris
- Larger design offers increased level of warmth and protection
- Ultimate Series Handguard Kit includes mounts

» 2890579-266

SPORTSMAN 850/1000 TOURING '10-24, SPORTSMAN 850/1000 '09-24, SPORTSMAN XP 1000 S '20-24

NOT COMPATIBLE WITH WINDSHIELDS OR HANDLEBAR MOUNTED MIRRORS



NEW HAND & THUMB WARMER JUMPER HARNESS

- Required for Hand & Thumb Warmer Kit installation on select vehicles

» 2890685

SPORTSMAN XP 1000 S '20, SPORTSMAN 850/1000 '15-20, SPORTSMAN TOURING 850/1000 '15-24



HANDGUARDS

- Handguard Mount (2889341) is required when installing Polaris Handguards
- Does not fit with windshield or Handlebar Mounted Mirrors

SPORTSMAN 850/1000 TOURING '10-24, SPORTSMAN 850/1000 '09-24, SPORTSMAN XP 1000 S '20-24

BRIGHT WHITE 2876883

BLACK TOP SELLER 2876846

INDY RED 2876845

» MOUNT • 2889341



REAR POWER HARNESS

- Provides power to the rear of the ATV for electrical accessories including Rear Audio Storage Box

» 2889071

SPORTSMAN XP 1000 '17-24, SPORTSMAN 850 '17-24, SPORTSMAN XP 1000 S '20-24

SPORTSMAN

XP 1000 XP 1000 S



WINDSHIELDS

LR LOCK & RIDE WINDSHIELDS

- Provides enhanced protection from the elements and off-road hazards
- Easily installs and removes without tools utilizing Lock & Ride technology
- Improved mounting system for easier and quicker attachment and detachment

SIZE	COLOR	PART #
TALL 48.9 cm	CLEAR	2884945
MID 39.4 cm	CLEAR	2884845
SMALL 24.1 cm	CLEAR	2884946

SPORTSMAN XP 1000 S '21-24, SPORTSMAN XP 1000 '21-24, SPORTSMAN 850 '21-24



TOP SELLER
TALL 48.9 cm CLEAR
2884945



TOP SELLER
MID 39.4 cm CLEAR
2884845



SMALL 24.1 cm CLEAR
2884946

LR LOCK & RIDE WINDSHIELDS

- Installs and removes in seconds without tools with Lock & Ride technology
- Poly windshields are flexible, impact-resistant, and provide long-term value over the life of your machine
- Does not work with Handguards

SIZE	COLOR	PART #
TALL 48.9 cm	CLEAR	2880539-409
MID 39.4 cm	SMOKE	2880540-412

SPORTSMAN TOURING XP 1000 '15-24, SPORTSMAN TOURING 850 '15-24



TALL 48.9 cm CLEAR
2880539-409



MID 39.4 cm SMOKE
2880540-412



DO MORE



PLOWS P. 34

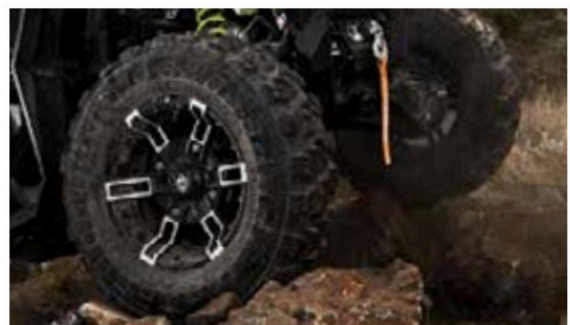

WHEELS & TIRES P. 38



LIGHTING P. 46

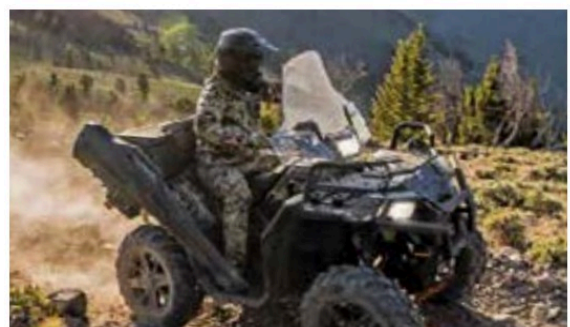

HUNT P. 48

SCRAMBLER XP 1000 S



WINCHES



POLARIS PRO HD 1,588 kg WINCH TOP SELLER

» 2883580
SCRAMBLER XP 1000 S '20-24



» 2889471
SCRAMBLER 850 '14-24,
SCRAMBLER XP 1000 '14-18



POLARIS HD 1,588 kg WINCH

» 2889470
SCRAMBLER 850 '14-24, SCRAMBLER XP 1000 '14-18



POLARIS HD 1,134 kg WINCH

» 2889469
SCRAMBLER 850 '14-24, SCRAMBLER XP 1000 '14-18

RACKS/STORAGE



LARGE REAR RACK

» 2879139
SCRAMBLER XP 1000 S '20-24, SCRAMBLER XP 1000 '14-18, SCRAMBLER 850 '14-24
NOT COMPATIBLE WITH OGIO BAG (2879925)



OGIO BAG

» 2879925
SCRAMBLER XP 1000 S '20-24, SCRAMBLER XP 1000 '14-18, SCRAMBLER 850 '14-24
NOT COMPATIBLE WITH LARGE REAR RACK (2879139)



PROTECTION



ULTIMATE SPORT SERIES FRONT BRUSHGUARD

» 2883595

SCRAMBLER XP 1000 S '20-24



FRONT BRUSHGUARD

» 2879136

SCRAMBLER 850 '14-24, SCRAMBLER XP 1000 '14-18
REPLACES EXISTING LOWER BUMPER - WILL NOT WORK TOGETHER

COMFORT



HANDGUARD

- Handguard Mount (2889341) is required when installing Polaris Handguards
 - Does not fit with windshield or Handlebar Mounted Mirrors
- SPORTSMAN XP 1000 S '20-24, SPORTSMAN 850/1000 TOURING '10-24, SPORTSMAN 850/1000 '09-24

<input type="checkbox"/>	BRIGHT WHITE	2876883
<input checked="" type="checkbox"/>	BLACK <small>TOP SELLER</small>	2876846
<input type="checkbox"/>	INDY RED	2876845

» 2889341 • MOUNT



NEW LATE AVAILABILITY
ULTIMATE SERIES HANDGUARD KIT

- Protects riders from wind, snow, ice, branches, and other trail debris
- Larger design offers increased level of warmth and protection
- Ultimate Series Handguard Kit includes mounts

» 2890579-266

SCRAMBLER XP 1000 S '20-24, SCRAMBLER 850 '14-24, SCRAMBLER XP 1000 '14-18
NOT COMPATIBLE WITH WINDSHIELDS OR HANDLEBAR MOUNTED MIRRORS

MISCELLANEOUS

ACCESSORIES



NEW LATE AVAILABILITY
CHAINSAW MOUNT

- Heavy-duty, black powder-coated metal bracket is designed to transport your chain saw safely and securely
 - With Lock & Ride technology, it can be secured to the outside of the rack in seconds, without tools, so your chainsaw is within reach at all times
 - Accommodates any brand electric chainsaw (sold separately)
 - Rubber pads provide cushion and tight fit
 - 15 lbs weight capacity
- » 2890580
SPORTSMAN 450/570 '21-24



RIDE & REPAIR ESSENTIALS KIT

- 12-volt DC portable air compressor
 - Tire repair kit with 6 plugs
 - Basic first-aid kit with bandages, scissors, safety pins, and more
 - 12-volt jumper cables
 - Duct tape - 300mm x 1 roll
 - Zip ties - 150mm length
 - Electrical tape
 - Ratchet strap - 50mm
 - Microfiber cloth
 - Carry bag
- » 2881207



QUICKTAP BATTERY POSTS

- Easy-to-access terminal posts give you quick access to the battery power
 - Ideal for charging your battery, powering a temporary accessory, or when you need to offer an unexpected jump-start
 - Connection posts feature covers to protect terminals when not in use
- » 2882110



ATV LICENSE PLATE

- Includes numbers and letters
- » 2873270



RECOVERY STRAP

- 5 cm x 9.1 m (8165 kg)
 - Comes with carry bag
- » 2884033

TRAILERING AND ADDITIONAL STRAPS P. 64

YOUTH ATV OUTLAW 70 EFI

The perfect first all-terrain vehicle
for kids starting at 6 years and older.



ACCESSORIES

570

XP 1000 /
XP 1000 S

SCRAMBLER
XP 1000 S

MISCELLANEOUS
& YOUTH

WINCHES, PLOWS
& TRACKS

WHEELS & TIRES

LIGHTING

HUNT & COOLERS



FRONT BRUSHGUARD

- Provides enhanced protection from brush and other debris on the trail

» 2884567

OUTLAW 70 EFI '21-24



WINDSHIELD - POLY

- Added wind and hand protection with a durable poly design

» 2885005

OUTLAW 70 EFI '21-24



REAR BRUSHGUARD

- Protect the rear of your youth ATV from hazards on the trails

» 2884778

OUTLAW 70 EFI '21-24



REAR STORAGE BAG

- Convenient storage that easily connects to the rear rack

» 2884555

OUTLAW 70 EFI '21-24

Images taken on private land. The use of vehicles by youth in similar environments in your jurisdiction may be prohibited per locally applicable laws and regulations. Keep your children safe and make sure an adult exercises close supervision at all times.

WINCHES



ADD A PLOW
P. 34

DEPENDABLE. TOUGH. BUILT FOR THE OFF-ROAD.

A Polaris Engineered winch is designed to help you get the job done right, get you on your way faster and prepare you for the unexpected.

WHY POLARIS?

Polaris Off Road vehicles are engineered with designated mounting points and wiring for seamless install of Polaris Engineered winches.



TESTED **1,200+**
PULLS AT MAX LOAD



BUILT TO WITHSTAND
-29° C TEMPERATURES



OPERATES
FULLY SUBMERGED



MILITARY
TESTED & APPROVED

FEATURES & BENEFITS

ALL POLARIS ENGINEERED WINCHES COME WITH:

- ✓ INTEGRATED WIRING, MOUNT, PREASSEMBLED
- ✓ HOOK WITH STRAP
- ✓ CUT STEEL GEARS & SEALED DRIVETRAIN
- ✓ SEALED PERMANENT MAGNET MOTOR



Retrieve cable 5x as fast as standard mode on other Polaris winches. Get back to riding or complete your task quicker.

1. Set winch dial to N (Neutral) to manually pull the rope out and secure the hook to your anchor point
2. Set winch dial to L (Low) for maximum pulling power while winching your load
3. Set winch dial to H (High) for retrieving the rope 5x faster with Rapid Rope Recovery

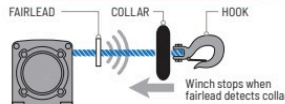

Auto Stop technology protects and extends the life of your winch by automatically stopping the winch at the end of pull to prevent over-spooling. While plowing, it prevents the plow frame from bending by stopping the winch once the plow has been lifted.



With its lightweight, yet extremely strong, design and superior flexibility, this 15.2 m long synthetic rope is easy to handle and can stand up to any tough job.



This convenient remote operates your Polaris winch wirelessly from within 15.2 m of the vehicle. Operate your winch safely outside your vehicle while on the job site or trails.

MODEL

450 H.O. '21-24
570 '21-24

450 H.O. '16-20
570 '14-20
X2 570 '15-21
TOURING 570 '14-23
6X6 570 '17-23

850 '12-24
XP 1000 '15-24
TOURING XP 1000 '15-24
TOURING 850 '15-24
SCRAMBLER 850 '14-24

XP 1000 S '20-24
SCRAMBLER XP 1000 S '20-24



TOP SELLER
**REPLACEMENT
SYNTHETIC ROPE**

» 1,134 kg • 2878888



**REPLACEMENT
STEEL CABLE**

• 1,588 kg winch series - 15.2 m
» 2878890



TOP-OF-THE-LINE FEATURES

BEST FOR PLOWING, HEAVY-DUTY OUTDOOR CHORES & TRAIL RIDING



BUILT FOR THE OFF-ROAD

BEST FOR THE CASUAL OFF-ROAD RIDER

PRO PRO HEAVY DUTY SERIES

HD HEAVY DUTY SERIES



NOT AVAILABLE



ADD AUTO STOP TECHNOLOGY



2881693

SYNTHETIC ROPE REQUIRED
FITS WINCHES: 2880434, 2880432



2889253

SYNTHETIC ROPE REQUIRED
FITS WINCHES: 2884832, 2884833,
2889469, 2889470



TOP SELLER
ADD SYNTHETIC ROPE
2878888



ADD WIRELESS WINCH REMOTE
2879316

1588 kg
WITH SYNTHETIC ROPE

1588 kg
WITH SYNTHETIC ROPE

1134 kg
WITH STEEL CABLE

2884834

2884833

TOP SELLER
2884832

2880434

TOP SELLER
2880432

2889471

2889470

2889469

2883580

570

XP 1000 /
XP 1000 S

SCRANBLER
XP 1000 S

MISCELLANEOUS
& YOUTH

WINCHES, PLOWS
& TRACKS

WHEELS & TIRES

LIGHTING

HUNT & COOLERS

PLOWS

TAKE COMMAND OF CLEARING SNOW AND MAKE QUICK WORK OF EVEN THE HEAVIEST JOBS.



DRIVE UP



CLIP IN



LOCK DOWN



ANGLE YOUR BLADE RIGHT FROM YOUR SEAT WITH THE GLACIER PRO PLOW HYDRAULIC ANGLE SYSTEM

INSTALLATION

30 seconds: drive up, clip in, lock down, and go – the integrated Polaris Engineered Glacier Plow System simplifies plowing.

CONVENIENCE

Lift and angle adjustments can be made from the driver's seat.

ROBUST FRAME

A plow system is only as strong as its frame, and Polaris Engineered plow frames have a wide frame to withstand the rigors of heavy plowing.



DURABLE BLADES

Available in strong stamped steel or corrosion-resistant poly materials, Polaris Engineered plow blades cover a large surface area for quick snow removal.

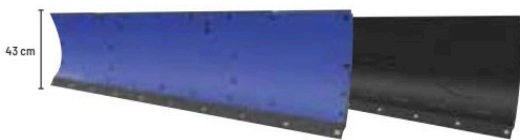

168 cm POLY BLADE

152 cm & 132 cm STEEL BLADE



PLOW SYSTEMS (WINCH REQUIRED, SOLD SEPARATELY)

Choose a Glacier Plow System, designed to help you get the most out of your Sportsman during snowy months. Select a system based on your plowing needs with premium add-ons including a hydraulic lift system or additional plow accessories.

GLACIER PRO HD PLOW SYSTEM WITH HYDRAULICS

System includes:

- Mount (2881424)
- Frame (2879630)
- 167.64 cm Poly Plow (2880269)
- Hydraulic Angle (2879635)
- Hydraulic Controller (2880836)
- Plow Markers (2872726)
- Plow Deflector (2879866)

» 3880010

450 '15-24, 570 '15-24, 6X6 570 '17-23, X2 570 '15-21, 570 TOURING '15-22

REQUIRES LIFT METHOD: SEE WINCHES BELOW

GLACIER PRO HD PLOW SYSTEM

System includes:

- Mount (2881424)
- Frame (2879630)
- 152.4 cm Steel Plow (2879638)

» 3880011

450 '15-24, 570 '15-24, 6X6 570 '17-23, X2 570 '15-21, 570 TOURING '15-22

REQUIRES LIFT METHOD: SEE WINCHES BELOW

GLACIER PRO HD PLOW SYSTEM WITH HYDRAULICS

System includes:

- Mount (2881423)
- Frame (2879630)
- 167.64 cm Poly Plow (2880269)
- Hydraulic Angle (2879635)
- Hydraulic Controller (2880836)
- Plow Markers (2872726)
- Plow Deflector (2879866)

» 3880012

XP 1000 '15-24, 850 '15-24, TOURING 1000 '15-24, TOURING 850 '15-24, SCRAMBLER 850 '15-24

REQUIRES LIFT METHOD: SEE WINCHES BELOW

GLACIER PRO HD PLOW SYSTEM

System includes:

- Mount (2881423)
- Frame (2879630)
- 152.4 cm Steel Plow (2879638)

» 3880013

XP 1000 '15-24, 850 '15-24, TOURING 1000 '15-24, TOURING 850 '15-24, SCRAMBLER 850 '15-24

REQUIRES LIFT METHOD: SEE WINCHES BELOW



GLACIER PRO HD PLOW SYSTEM

168 cm, 152 cm or 132 cm blades

Choice of poly or steel

Ability to add a hydraulic angle system

MODELS	MANDATORY STEPS			OPTIONAL	
	STEP 1 SELECT A MOUNT	STEP 2 SELECT A FRAME	STEP 3 SELECT PLOW CONFIGURATION	BLADES	STEP 4 ADD HYDRAULICS
XP 1000 '15-24 850 '15-24 850/XP 1000 HIGHLIFTER '16-24 TOURING XP 1000 '15-24 TOURING 850 '10-24 SCRAMBLER 850 '14-24	TOP SELLER 2881423		Polaris Pro HD 1,588 kg Winch 2889471 Polaris HD 1,588 kg Winch 2889470 Polaris HD 1,134 kg Winch 2889469		
XP 1000 S '20-24 SCRAMBLER XP 1000 S '20-24	2883581		Polaris Pro HD 1,588 kg Winch 2883580	168 cm Poly 2880269	Hydraulic Plow Blade Angle System 2879635
570 '15-20 6X6 570 '17-23 X2 570 '15-23 TOURING 570 '14-23 450 H.O. '12-20		TOP SELLER 2879630	TOP SELLER Polaris HD 1,588 kg Winch 2880434 TOP SELLER Polaris HD 1,134 kg Winch 2880432	TOP SELLER 152 cm Steel 2879638	Power Controller 2880836
570 '21-24 450 H.O. '21-24	TOP SELLER 2881424		TOP SELLER Polaris Pro HD 1,588 kg Winch 2884834 TOP SELLER Polaris HD 1,588 kg Winch 2884833 TOP SELLER Polaris HD 1,588 kg Winch 2884832	TOP SELLER 132 cm Steel 2879639	POWER CONTROLLER RECOMMENDED, SOLD SEPARATELY

STEP 5 SELECT ACCESSORIES AND REPLACEMENT ITEMS

168 cm HD Wear Bar 2879868 168 cm Wear Bar 2879867 152 cm Wear Bar 2877243 132 cm Wear Bar 2877210 ■■■ 152 cm UHMW Wear Bar 2890651 ■■■ 132 cm UHMW Wear Bar 2890652	168 cm Plow Blade Snow Deflector 2879866 152 cm Plow Blade Deflector 2871808 Skid Shoe 2208864 Glacier Pro Shear Pin Replacement 2205063 Coil Spring Spacer 2872655	Plow Winch Rope (for 1,134 kg & 1,588 kg winches) 2878483 Glacier Plow Marker (sold in pairs) 2872726 Rear Tire Chains (recommended for rear tires only) 2881422 Plow Blade Track Extension (required for track equipped vehicles) 2879719
---	---	---

CHOOSE A PLOW SYSTEM

BUILD A PLOW SYSTEM

ACCESSORIES

570

XP 1000 / XP 1000 S

SCRAMBLER XP 1000 S

MISCELLANEOUS & YOUTH

WINCHES, PLOWS & TRACKS

WHEELS & TIRES

LIGHTING

HUNT & COOLERS

ALL-TERRAIN TRACTION

It's tough to make Sportsman even more versatile than it already is. But with a set of Prospector Pro Tracks, you'll do just that. Tread through deep snow without concern.

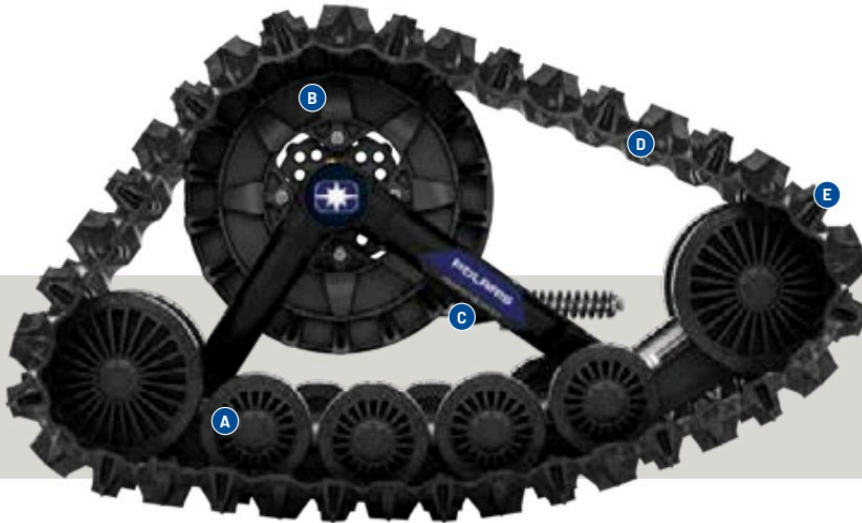

PROSPECTOR PRO 2.0 TRACK SYSTEM

- A** New front dual stabilizer for improved stability
- B** Polaris-specific gearing provides 1:1 ratio to:
 - Minimize track slip, providing better climbing ability and improved traction in deep snow
 - Improve top speed over prior models by approximately 5%
 - Reduce operating RPM for a quieter ride
 - Improve driveline durability, which allows vehicle to run at a lower RPM, decreasing engine wear
- C** Polaris exclusive optimized hub geometry that minimizes feedback and eases steering effort
- D** Lightweight design provides for better flotation, eases steering effort, and provides better vehicle control
- E** Flexible lug design provides the highest level of deep snow performance by lifting up in deep snow as opposed to digging down

STEP 1 SELECT A MOUNT KIT		
MODELS	A-ARMS	MOUNT KIT
XP 1000/850 '15-24 TOURING XP 1000/850 '15-24	STRAIGHT	2879457
XP 1000/850 '16-24 HIGHLIFTER 1000/850 '16-24	ARCHED	2882109
XP 1000 S '20-24 SCRAMBLER XP 1000 S '20-24	ARCHED	2883977
570 '14-24	ARCHED	2889218
450/570 '14-24	STRAIGHT	2889219
570 '14-24 TOURING 570 '15-23 X2 570 '15-23	STRAIGHT	2879497

STEP 2 SELECT A TRACK KIT	
MODELS	TRACK KIT
450/570 '14-24 TOURING 570 '15-23 X2 570 '15-23	2889493
XP 1000 '15-24 850 '15-24 TOURING XP 1000/850 '17-24 HIGHLIFTER 1000 '16-24 XP 1000 S '20-24 SCRAMBLER XP 1000 S '20-24 SCRAMBLER 850 '13-24	2889495

WANT TO PLOW?

GLACIER PRO PLOW TRACK EXTENSION

- Plow extension for use when using the Prospector Pro Track System and Glacier Pro Plow System









» 2879719

FOR USE WITH GLACIER PRO PLOW SYSTEMS





SPORTSMAN SNOW TRACTION OPTIONS

TREAD THROUGH SNOW WITH THESE OPTIONS	CONTACT PATCH	TURNING RADIUS
 <p>STOCK TIRES</p>	<p>GOOD</p> 	<p>354 cm</p> 
 <p>PRO ARMOR WHITEOUT</p>	<p>BETTER</p>  <p>More surface area for better flotation on snow</p>	<p>353 cm</p> 
 <p>PROSPECTOR PRO 2.0 TRACKS</p>	<p>BEST</p>  <p>Less aggressive tread displaces snow for better handling</p>	<p>446 cm</p> 

WHEELS & TIRES



KNOW YOUR TIRES

DIMENSIONS			USAGE	TREAD DEPTH	TIRE WEIGHT	PLY RATING	SIDEWALL BELTS	LOAD RATING
26" x 11" R14 Part Number			FRONT/ REAR	16 mm	14 kg	10	3	499 kg
TIRE HEIGHT	TIRE WIDTH	WHEEL DIAMETER	Where can you use the tire	Deeper treads have more grip in all conditions	A lighter tire makes for improved vehicle performance	Indicates tire puncture-resistance	Increase your resistance to sidewall punctures	How much weight can the tire handle

WAYS TO SHOP >>>



PRO ARMOR.

TIRES BY SIZE

26"	27"
ATTACK	HARVESTER
DUAL-THREAT	MUD XC
HARVESTER	PRESERVE
PRESERVE	TREKKER
TREKKER	WHITEOUT
XD-K	X TERRAIN

SUPERIOR PERFORMANCE & DURABILITY

LIFELONG PERFORMANCE

- Every tire is designed and constructed with longevity in mind
- 3,000+ mile rated (4,828 kilometers)

PREMIUM PROTECTION

- Pro Armor makes tires with extra protection exactly where it's needed most – the sidewall
- Triple-belted sidewalls keep your tires more resistant so you can keep going

TOUGH TIRES

- Higher ply ratings mean added protection
- Pro Armor builds 8 or 10-ply rated tires for higher puncture-resistance

KNOW YOUR TERRAIN



- Tread patterns optimized for extreme traction
- Ideal for both hard pack & loose trail



- Extra deep treads
- Self-cleaning lugs



- Provides traction & durability
- Performs in hard sand, jagged rocks or any extreme terrain



- Triple-belted sidewalls to resist puncture
- Purpose-built, long lasting tread patterns



- Flexible "grippy" tread
- Aggressive side bite



- Handles extreme cold
- Holds shape & provides traction

KNOW YOUR WHEELS

STEP 1: SELECT YOUR SERIES

4 = 40-SERIES

STEP 2: CHOOSE YOUR LOAD RATING

1 = <362.9 kg 2 = 363 - 589.7 kg 3 = 590 - 726+ kg

STEP 3: PICK YOUR STYLE

OFFSET / BEADLOCK / COLOR

INCREASE OFFSET FROM STOCK = NARROWER STANCE
DECREASE OFFSET FROM STOCK = WIDER STANCE

TIRES BY TERRAIN

TRAIL	ROCK	DESERT	MUD	UTILITY	SNOW
ATTACK	DUAL-THREAT	ATTACK	MUD XC	HARVESTER	ATTACK
DUAL-THREAT		DUAL-THREAT		PRESERVE	HARVESTER
HARVESTER				TREKKER	PRESERVE
MUD XC				XD-K	XD-K
PRESERVE				X TERRAIN	WHITEOUT
TREKKER					
X TERRAIN					
XD-K					

WHEELS BY SIZE

14" 40-SERIES (12 TIRE OPTIONS)
4101
4201
4202
4203 BEADLOCK
4204
4205
4206
4301 BEADLOCK
HD DUAL BEADLOCK

TIRES

PICKING THE RIGHT UTILITY TIRE

UTILITY FEATURE	PRESERVE	XD-K	HARVESTER	X TERRAIN
8,047 Kilometer Rated Long life and performance	X		X	X
10-Ply Rated Higher ply ratings means added protection	X	X	X	
Low Impact Tread Easy on soil	X			
Heavy-Duty Tread Aggressive tread pattern for all day work on farms or ranches		X	X	X
Turf-Friendly Easy on grass and farm yard	X		X	X
Aramid Fiber Belt 5x times stronger than steel and lighter		X		
Size Options For exactly how you want to use your machine	26", 27"	26"	26", 27"	27"



FRONT/REAR

PRO ARMOR PRESERVE

- Turf-friendly for areas where low impact from tire tread is needed
- Exceptionally quiet-running and low impact

	TREAD DEPTH	TIRE WEIGHT	PLY RATING	SIDEWALL BELTS	LOAD RATING
12" 26" x 8" R12 5416403	16 mm	11 kg	10	3	388 kg
12" 26" x 10" R12 5416402		13 kg			599 kg
14" 27" x 10" R14 5416348		13 kg			599 kg



WHEEL SIZE



FRONT/REAR

PRO ARMOR XD-K

- 26" Aramid fiber-belted tire can tackle any terrain
- Unique full-face tread design
- Harder durometer lugs promote extended wear, increasing tire life

	TREAD DEPTH	TIRE WEIGHT	PLY RATING	SIDEWALL BELTS	LOAD RATING
12" 26" x 9" R12 5415756	31.7 mm	13 kg	8	3/1 Aramid	388 kg
12" 26" x 11" R12 5415757		15 kg			499 kg



WHEEL SIZE





FRONT/REAR

PRO ARMOR HARVESTER

- All-around workhorse with tread life of 8,047 kilometers
- Tread pattern designed to withstand anything from the farmyard to the pastures to the trail
- With 10-ply, it can carry the load day-in and day-out

			TREAD DEPTH	TIRE WEIGHT	PLY RATING	SIDEWALL BELTS	LOAD RATING
12"	26" x 8" R12 5416396	FRONT	16 mm	11 kg	10	3	388 kg
12"	26" x 10" R12 5415966	REAR		15 kg			615 kg
14"	27" x 10" R14 5415965	FRONT/ REAR		15 kg			599 kg



WHEEL SIZE



FRONT/REAR

X TERRAIN - E-MARKED

- Built to perform through the toughest obstacles on any trail
- Durability-driven design to provide a comfortable, confident ride
- 8-ply, triple-belted ballistic sidewalls resist punctures

			TREAD DEPTH	TIRE WEIGHT	PLY RATING	SIDEWALL BELTS	LOAD RATING
14"	27" x 9" R14 5418071	FRONT	16 mm	12 kg	8	3	365 kg
14"	27" x 11" R14 5418072	REAR		14 kg			438 kg



WHEEL SIZE



TIRES



FRONT/REAR

NEW

PRO ARMOR TREKKER

- Specialized tread design provides a quiet ride
- Graduated lug depth maximizes the contact patch for ultimate predictability
- 8-ply, triple belted nylon construction

			TREAD DEPTH	TIRE WEIGHT	PLY RATING	SIDEWALL BELTS	LOAD RATING
12	26" x 10" R12 5418673	FRONT/ REAR	11-17 mm graduated	13 kg	8	3	463 kg
14	27" x 10" R14 5418674			13 kg			490 kg



WHEEL SIZE

12" 14"



FRONT/REAR

PRO ARMOR DUAL-THREAT

- Dual-compound technology and radial construction offer performance in all terrains
- Softer durometer rubber on outer edge for overall superior grip and feel
- Harder durometer rubber in the middle for increase traction during acceleration and longer tread life

			TREAD DEPTH	TIRE WEIGHT	PLY RATING	SIDEWALL BELTS	LOAD RATING
14	26" x 9" R14 5416340	FRONT	16 mm	12 kg	10	3	413 kg
14	26" x 11" R14 5416341	REAR		14 kg			504 kg



WHEEL SIZE

14"



FRONT/REAR

PRO ARMOR ATTACK

- The best all-purpose tire for all-season traction in any terrain
- Unique full-face tread design
- Harder durometer lugs promote extended wear, increasing tire life

			TREAD DEPTH	TIRE WEIGHT	PLY RATING	SIDEWALL BELTS	LOAD RATING
14	26" x 9" R14 5415613	FRONT	23 mm	13 kg	8	3	413 kg
14	26" x 11" R14 5415614	REAR		15 kg			599 kg



WHEEL SIZE

14"



FRONT/REAR

PRO ARMOR WHITEOUT

- Extra wide tires for flotation in snow
- Tread pattern designed for superior snow traction with limited digging

			TREAD DEPTH	TIRE WEIGHT	PLY RATING	SIDEWALL BELTS	LOAD RATING
14"	27" x 14" R14 5416032	FRONT/ REAR	16 mm	11 kg	8	3	424 kg



WHEEL SIZE

14"

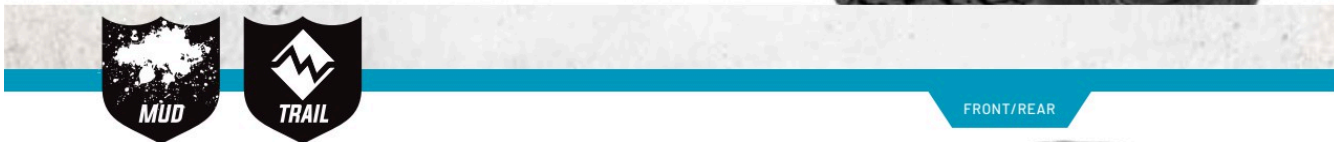

FRONT/REAR

PRO ARMOR MUD XC

- Designed as the perfect mud-trail crossover for a smooth ride on the trail and aggressive traction in the mud
- Dual-compound technology with harder durometer lugs promotes extended wear, increasing tire life
- 10-ply construction means added protection in the toughest terrain

			TREAD DEPTH	TIRE WEIGHT	PLY RATING	SIDEWALL BELTS	LOAD RATING
14"	27" x 9" R14 5416947	FRONT	30 mm	14 kg	10	3	531 kg
14"	27" x 11" R14 5416948	REAR		15 kg			599 kg



WHEEL SIZE

14"



WHEELS



BEADLOCK REQUIRED

BEADLOCK INCLUDED

INNER AND OUTER
BEADLOCK INCLUDED



40-SERIES

A 4101 ○

FRONT WEIGHT: 6.6 kg	LOAD RATING: 363 kg	OFFSET: -35
MATTE BLACK	FRONT/REAR	14" x 10"
		1522958

D 4203 BEADLOCK ○

FRONT WEIGHT: 5.9 kg	LOAD RATING: 408 kg	OFFSET: +4
REAR WEIGHT: 6.6 kg	LOAD RATING: 590 kg	OFFSET: -9
MATTE BLACK	FRONT	14" x 7"
	REAR	14" x 8"
		1522238-458
		1522239-458

G 4206 ○

FRONT WEIGHT: 4.3 kg	LOAD RATING: 408 kg	OFFSET: +4
REAR WEIGHT: 4.9 kg	LOAD RATING: 590 kg	OFFSET: -9
MATTE BLACK	FRONT	14" x 6"
	REAR	14" x 8"
		1522542-458
		1522543-458

B 4201 ○

FRONT WEIGHT: 5.9 kg	LOAD RATING: 408 kg	OFFSET: +9
REAR WEIGHT: 6.4 kg	LOAD RATING: 590 kg	OFFSET: +9
ACCENT	FRONT	14" x 7"
	REAR	14" x 8"
		1522956-266
		1522957-266
MATTE BLACK	FRONT	14" x 7"
	REAR	14" x 8"
		1522956-458
		1522957-458

E 4204 ○

FRONT WEIGHT: 5.9 kg	LOAD RATING: 408 kg	OFFSET: +4
REAR WEIGHT: 6.4 kg	LOAD RATING: 590 kg	OFFSET: -9
ACCENT	FRONT	14" x 7"
	REAR	14" x 8"
		1522546-266
		1522547-266
MATTE BLACK	FRONT	14" x 7"
	REAR	14" x 8"
		1522546-458
		1522547-458

H 4301 BEADLOCK

WEIGHT: 7.3 kg	LOAD RATING: 726 kg	OFFSET: +38
ACCENT	FRONT/REAR	14" x 7"
		1523284
MATTE BLACK	FRONT/REAR	14" x 7"
		1523283

C 4202 ○

FRONT WEIGHT: 5.8 kg	LOAD RATING: 408 kg	OFFSET: +4
REAR WEIGHT: 6.1 kg	LOAD RATING: 590 kg	OFFSET: -9
ACCENT	FRONT	14" x 7"
	REAR	14" x 8"
		1522544-266
		1522545-266
MATTE BLACK	FRONT	14" x 7"
	REAR	14" x 8"
		1522544-458
		1522545-458

F 4205 ○

FRONT WEIGHT: 4.8 kg	LOAD RATING: 408 kg	OFFSET: +4
REAR WEIGHT: 5.7 kg	LOAD RATING: 590 kg	OFFSET: -9
MATTE BLACK	FRONT	14" x 7"
	REAR	14" x 8"
		1521507-521
		1521508-521
LUSTER	FRONT	14" x 7"
	REAR	14" x 8"
		1521507-410
		1521508-410

I HD DUAL BEADLOCK ○

WEIGHT: 18.1 kg	LOAD RATING: 725.7 kg	OFFSET: +38
MATTE BLACK	FRONT/REAR	14" x 7"
		1524022-458

14" FORGED BEADLOCK RINGS

MACHINED 1522244-266

ONLY USED ON 4203 BEADLOCK & HD DUAL BEADLOCK
SOLD INDIVIDUALLY

MATTE BLACK 1523146-458

ONLY USED ON 4301 BEADLOCK & HD DUAL BEADLOCK
SOLD INDIVIDUALLY



KNOW YOUR WHEELS

STEP 1: SELECT YOUR SERIES

4 = 40-SERIES

STEP 2: CHOOSE YOUR LOAD RATING

1 = <362.9 kg 2 = 363 - 589.7 kg 3 = 590 - 726+ kg

STEP 3: PICK YOUR STYLE

OFFSET / BEADLOCK / COLOR

INCREASE OFFSET FROM STOCK = NARROWER STANCE
DECREASE OFFSET FROM STOCK = WIDER STANCE

2 WAYS TO PURCHASE

INDIVIDUAL WHEELS & TIRES
- OR -
COMPLETE SETS AS LISTED

Exclusively at Polaris Authorized Dealers

KNOW YOUR TERRAIN



- Tread patterns optimized for extreme traction
- Ideal for both hard pack & loose trail



- Extra deep treads
- Self-cleaning lugs



- Triple-belted sidewalls to resist puncture
- Purpose-built, long lasting tread patterns



- Handles extreme cold
- Holds shape & provides traction

WHEEL & TIRE SETS

14"

40-SERIES

	TRAIL NEW TREKKER 27"	X TERRAIN 27"	ATTACK 26"	DUAL-THREAT 26"	MUD XC 27"	UTILITY PRESERVE 27"	HARVESTER 27"	SNOW WHITEOUT 27"
4101 MATTE BLACK								2882382
4201 ACCENT		2889966	2882390	2883138	2884272	2883208	2882388	
4201 MATTE BLACK		2889967	2882391	2883139	2884273	2883209	2882389	
4202 ACCENT	2890907	2889968	2881335	2883140	2884267		2882383	
4202 MATTE BLACK	2890905	2889969	2881336	2883141	2884268	2883204	2882384	
4203 BEADLOCK MATTE BLACK <small>BEADLOCKS SOLD SEPARATELY</small>		2889972	2881381					
4204 ACCENT		2889973	2881347	2883142	2884270	2883205	2882385	
4204 MATTE BLACK		2889974	2881348	2883143	2884271		2882386	
4205 LUSTER			2881359	2883144				
4205 MATTE BLACK		2889975	2881360	2883145	2884269	2883207	2882387	
4206 MATTE BLACK			2881404					
4301 BEADLOCK ACCENT <small>BEADLOCKS PRE-MOUNTED</small>		2889970			2883217			
4301 BEADLOCK MATTE BLACK <small>BEADLOCKS PRE-MOUNTED</small>		2889971			2883216			

LUG NUTS

Lug Nuts Required



METRIC LUG NUTS FOR ALUMINUM RIMS

- › SET OF 4 • 2877385
- › SET OF 16 • 2877384

SAE LUG NUTS FOR ALUMINUM RIMS

- › SET OF 4 • 2876754
- › SET OF 16 • 2877409

SPORTSMAN 450/570

REPLACEMENT CAPS

POLARIS CENTER CAP

HD MATTE BLACK	ALL WHEELS	5457498-458
--------------------------	------------	-------------

PRO ARMOR CENTER CAP

LUSTER	ALL WHEELS EXCEPT 4204 & 4203 BEADLOCK	5453209-410
MATTE BLACK		5453209-458

COLBY VALVE SHORT ULTIMATE VALVE - 2 PACK

› 2883292



COLBY VALVE EMERGENCY VALVE - 2 PACK

› 2883293



COLBY COMBO VALVE KIT - 16 PACK

- Includes eight Ultimate Valves and eight Emergency Valves

› 2883294

ORDERABLE THROUGH LOCAL DEALER ONLY





POLARIS ENGINEERED ADVANTAGES

MOUNTS PERFECTLY
Designed for your Polaris Engineered bumper, roof or other mounting point

ADVANCED TECH

RIGID lights are driven by Aluminum PCB Smart Boards, 6063-T5 aircraft aluminum extruded housings and Tiger Drylac UV protection polyester powdercoating.

EXCLUSIVE OPTICS

RIGID lights feature impact-resistant polycarbonate lenses for a 100% water/dustproof seal.

LIGHT BAR TYPES



SR-SERIES PRO

Sleek, powerful, low-profile (under 5 cm tall). Lights extreme distances with low energy usage.

Available in 25.4 cm Flood, Spot & Combo



D-SERIES PRO

Compact to fit almost anywhere with high output and low energy usage.

Available in Driving, Flood & Spot

OPTICS

DRIVING

FLOOD

LIGHT BAR OPTIONS

1,200 m

960 m

720 m

480 m

240 m

BRAND SIZE
TYPE
RAW LUMENS
PN

RIGID POD
D-SERIES
4,752
2883128
Comes in a pair

RIGID 25.4 cm
SR-SERIES
7,920
2883122

RIGID POD
D-SERIES
3,168
2883126
Comes in a pair

RIGID 25.4 cm
SR-SERIES
7,920
2883121

BUILD YOUR VISION

Consider the optics, angle and how you will use your vehicle to choose the right light or set of lights.

OPTICS LIGHT ANGLE	ACCENT	DRIVING (45°)	FLOOD (25°)	SPOT (10°)	COMBO (25°/10°)
DRIVING SPEED	All	Slow to medium	Slow to medium	High	All
BEAM	Diffused glow	Extra-wide	Wide/shorter	Concentrated/long	Inner spot & outer flood
RECOMMENDED MOUNTING	Low/wheel well	All points	Low/rear	High points	All points
TERRAIN & RIDING STYLE	Added style & personalization in any terrain	All riding & utility	Wide-open terrain or trails & utility	Trail & tight conditions	All riding & utility

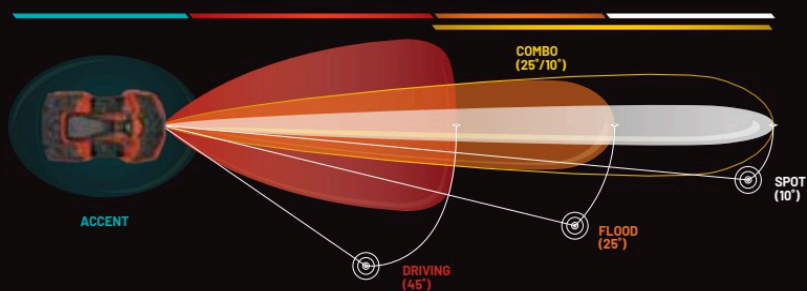

MAX PERFORMANCE

Validated to work as hard as your machine does

DOESN'T OVERTAX

Trust it to work when you need it to

PRO ARMOR®



RUGGED CONSTRUCTION

Pro Armor lights are designed to be big and beefy with an aggressive style all their own, and housed in IP67 marine-grade rated UV polyester powdercoating.

MASSIVELY BRIGHT

Pro Armor builds bright lights designed for any riding experience. All that power is directed through heat dissipating aluminum for streamlined heat management.



SINGLE-ROW LED

Powerful, compact, low-profile light bars with sleek look.

Available in 50.8 cm Combo



CUBE LED

Small size allows mounting in strategic locations for added lighting.

Available in Spot

SPOT

COMBO

OPTICS



RIGID
POD
D-SERIES
3,168

2883127
Comes in a pair

PRO ARMOR
CUBE
DUAL-ROW
1,500

2889794
2889795

RIGID
25.4 cm
SR-SERIES
7,920

2883123

1,200 m

960 m

720 m

480 m

240 m

BRAND
SIZE
TYPE

RAW LUMENS

PN

POLARIS ENGINEERED

LED LIGHT KIT

• Upgrade your standard headlights and pod lights to LEDs with this upgrade kit

» 2884859

SPORTSMAN XP 1000 S '21-24,
SPORTSMAN 850/1000 '21-24,
SPORTSMAN 450/570 '21-24

DOES NOT WORK WITH MODELS PRIOR TO '21
U.S. MODELS ONLY



LIGHTBAR HARNESS

• Control one light with one switch

» 2882320

ALL SPORTSMAN MODELS

LED Y-HARNESS

• Requires 2882320 to control two cubes or two lights with one switch

» 2879860

ALL SPORTSMAN MODELS

HUNT



PROTECTING YOUR ESSENTIAL GEAR SINCE 1943

KOLPIN STRONGHOLD SYSTEM

Polaris is proud to partner with Kolpin Outdoors, an industry leader in off-road accessories and the premier name in gun boots and mounts. If you need to secure a firearm while riding, simply attach the auto-latch mount and choose your Gun Boot.

IDEAL FOR SECURE TRANSPORT OF SCOPED RIFLES AND SHOTGUNS.

STEP 1 CHOOSE YOUR MOUNT



STRONGHOLD AUTO-LATCH MOUNT

- The Auto-Latch provides quick and secure attachment of Kolpin Stronghold Gun Boots
- Bracket is made from rugged high impact, reinforced nylon and coated steel with precision angle adjustment for a custom fit
- For use with Kolpin Stronghold Gun Boots (sold separately)

» 2882272

SPORTSMAN 850/1000 '17-24
DOES NOT FIT WITH ULTIMATE SERIES BODY ARMOR (2882090)

STRONGHOLD AUTO-LATCH MOUNT TOP SELLER

- The Auto-Latch provides quick and secure attachment of Kolpin Stronghold Gun Boots
- Bracket is made from rugged high impact, reinforced nylon and coated steel with precision angle adjustment for a custom fit
- For use with Kolpin Stronghold Gun Boots (sold separately)

» 2884846

SPORTSMAN 450/570 '21-24

STEP 2 CHOOSE YOUR BOOT



STRONGHOLD GUN BOOT L TOP SELLER

- 132.1 cm L x 12.1 cm W x 23.5 cm H
- Requires Auto-Latch Mount 2882272 or 2884846 to mount to vehicle

» 2882426

SPORTSMAN 850/1000 '17-24,
SPORTSMAN 450/570 '14-24

Never transport a loaded firearm. Verify firearm is unloaded prior to mounting. Please refer to local laws and regulations regarding the requirements for the legal transport of firearms.



KOLPIN RHINO GRIPS

IDEAL FOR CARRYING RIFLES, SHOTGUNS, BOWS AND CROSSBOWS.

LR LOCK & RIDE MAX RHINO GRIP PRO - ATV

- » 2884119
- » REPLACEMENT RUBBER STRAPS • 2884109
ALL SPORTSMAN MODELS (EXCEPT UTILITY EDITIONS & YOUTH)



LR LOCK & RIDE MAX RATCHETING RHINO GRIP - ATV TOP SELLER

- » 2881157
ALL SPORTSMAN MODELS (EXCEPT UTILITY AND YOUTH)



LR LOCK & RIDE MAX RHINO GRIP XLR - ATV

- » 2889147
- » REPLACEMENT RUBBER STRAPS (2) • 2889204
ALL SPORTSMAN MODELS (EXCEPT UTILITY EDITIONS & YOUTH)



LR LOCK & RIDE MAX RHINO GRIP XLR - DOUBLES - ATV

- » 2889148
- » REPLACEMENT RUBBER STRAPS (2) • 2889204
ALL SPORTSMAN MODELS (EXCEPT UTILITY EDITIONS & YOUTH)



All Kolpin Rhino Grips are Lock & Ride MAX / Lock & Ride compatible and come with required mounting hardware.

ADDITIONAL STORAGE OPTIONS

KOLPIN GUN BOOT IV

- For 50mm scopes, rifles with slings attached, or shotguns up to 129.54 cm in length
- » BLACK • 2872677
REQUIRES MOUNT 2878001 TO MOUNT TO SPECIFIC SPORTSMAN MODELS



LR LOCK & RIDE GUN BOOT MOUNTS

- Works with Lock & Ride XL Storage Box, Lock & Ride Rear Cargo Box, and Rear Rack Extenders
- » 2878001
SPORTSMAN 850/1000 TOURING '10-24
ONLY COMPATIBLE WITH KOLPIN GUN BOOT IV - NOT COMPATIBLE WITH KOLPIN STRONGHOLD GUN BOOTS



STRONGHOLD GUN BOOT XL TOP SELLER

- Lockable and TSA Approved
- Includes padded, zippered internal protective liner
- 132.1 cm L x 9.5 cm W x 26.6 cm H
- Requires Auto-Latch Mount 2882272 or 2884846 to mount to vehicle
- » 2882036
XP 1000 '17-24, 850 '17-24, 570 '18-24, 450 H.O '21-24

COOLERS

MADE FOR RIDERS.
BUILT FOR LIFE.

28, 57 & 99
LITER FEATURES



ComfortCarry
Handles



TravelLock
System



EasyOut
Drain System



NoSlip
Rubber Feet



PolarWall
Insulation



IceLock
Seal



99 LITER

NEW SAGEBRUSH GREEN • 2890707
GRAPHITE • 2883426

ACCESSORIES

WIRE BASKET • 2883648
DIVIDER (1) • 2883468
WHEELS • 2883967

Divider



1 way to
partition



57 LITER

NEW SAGEBRUSH GREEN • 2890706
GRAPHITE • 2883425

ACCESSORIES

WIRE BASKET • 2882185
DIVIDERS (2) • 2882184
SEAT CUSHION • 2882179
WHEELS • 2882180

Dividers



2 ways to
partition



28 LITER

NEW SAGEBRUSH GREEN • 2890705
GRAPHITE • 2883424

ACCESSORIES

WIRE BASKET • 2882438
DIVIDER (1) • 2882186

Divider



1 way to
partition

ESSENTIAL ACCESSORIES SO YOUR COOLER WORKS AS HARD AS YOU DO



POLARIS
NORTHSTAR
COOLER



POLARIS NORTHSTAR COOLERS CAN SURVIVE JUST ABOUT ANYTHING - FROM EXTREME HEAT TO A NASTY TUMBLE OFF A VEHICLE.



14 LITER

NEW SAGEBRUSH GREEN • 2890704
GRAPHITE • 2883968



19 LITER
SOFT-SIDED COOLER

GRAPHITE • 2889285



HOLDS ICE
FOR AGES

BECAUSE JUST ANY COOLER
WON'T CUT IT OUT THERE.

You need something rugged and reliable. A cooler purpose built to handle the challenges of the off-road—while keeping your provisions on ice for days on end. Because out here, there are no ice machines, and you just left the last one in your dust. So, load it up. Lock it in. And know your NorthStar cooler is staying put—giving you a few extra days of ice time to enjoy the wild.



TUMBLER



591 mL • 2883393
NOT AVAILABLE IN EUROPE

ACCESSORIES

570

XP 1000 /
XP 1000 S

SCRABBLER
XP 1000 S

MISCELLANEOUS
& YOUTH

WINCHES, PLOWS
& TRACKS

WHEELS & TIRES

LIGHTING

HUNT & COOLERS

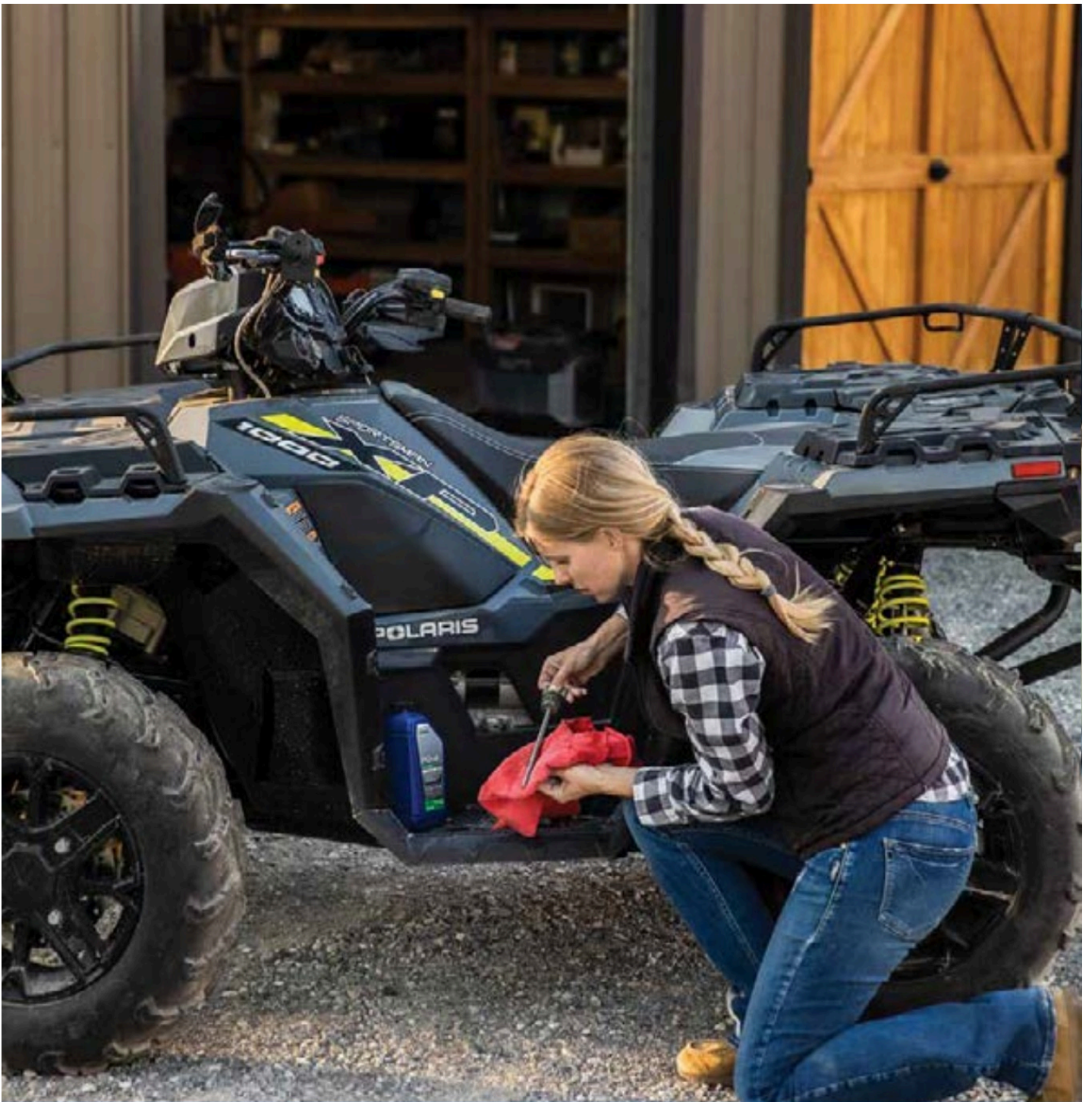

MAINTENANCE & GARAGE

FACTORY APPROVED. Every Polaris vehicle has been engineered and manufactured to deliver performance. Keep it that way by using the same lubricants, cleaners and service parts our factory-trained technicians use.



FOR THE LIFE OF YOUR RIDE

PUSH THE LIMITS WITHOUT SACRIFICING STRENGTH, LONGEVITY AND DURABILITY. Polaris parts are engineered specifically for your machine, to ensure you get the most out of each ride.

MAINTENANCE TIP

BREAK-IN PERIOD

The break-in period for your new Sportsman is the first 25 hours of operation, or the time it takes to use the first two tanks of fuel. No single action on your part is as important as a proper break-in period. Careful treatment of a new engine will result in more efficient performance and longer life for the engine.

NOTICE: Excessive heat build-up during the first three hours of operation will damage close-fitted engine parts. Do not operate at full throttle or high speeds for extended periods during the first three hours of use.

BATTERY

To ensure a battery maintains its level of charge when unused for extended periods of time or during freezing weather, the battery should be connected to a battery charger. Be sure to check for corrosion from the terminals to the ends of the cables.

BRAKE PADS

Brake pads should be checked for wear and oil or grease (petroleum products) contamination. Brake discs should be checked for cracks, excessive corrosion or warping.

HALF SHAFTS

Check for tears and punctures in the boot, which can lead to CV joint wear that can contribute to axle failure.

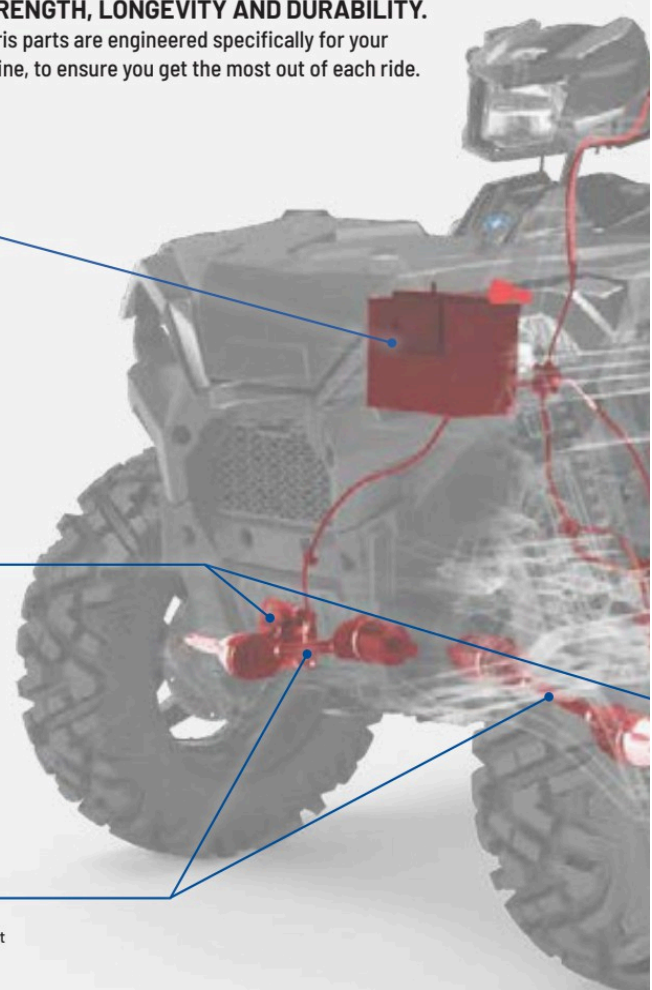

MAINTENANCE SCHEDULE*

BREAK-IN MAINTENANCE

FIRST 25 HRS / 1 MONTH | 250 MI / 400 KM

ENGINE OIL
CHANGE

GEARCASES
CHECK OIL LEVEL

AIR FILTER
INSPECT

REPLACE AS NEEDED

EXHAUST SYSTEM
INSPECT & CLEAN

INSPECT FOR LEAKAGE OR CARBON BUILD UP AT JOINTS

INSPECT & CLEAN SCREEN TYPE SPARK ARRESTOR

6 MONTHS

50 HRS | 500 MI / 800 KM

EXHAUST SYSTEM
INSPECT & CLEAN

INSPECT FOR LEAKAGE OR CARBON BUILD UP AT JOINTS

INSPECT & CLEAN SCREEN TYPE SPARK ARRESTOR

GENERAL LUBRICATION
ALL FITTINGS, PIVOTS, CABLES, ETC.

DRIVE BELT
INSPECT & ADJUST

REPLACE AS NEEDED

12 MONTHS

100 HRS | 1,000 MI / 1,600 KM

ENGINE OIL
CHANGE

DRIVE BELT
INSPECT & ADJUST

REPLACE AS NEEDED

SPARK PLUGS
REPLACE

EXHAUST SYSTEM
INSPECT & CLEAN

INSPECT FOR LEAKAGE OR CARBON BUILD UP AT JOINTS

INSPECT & CLEAN SCREEN TYPE SPARK ARRESTOR

18 MONTHS

150 HRS | 1,500 MI / 2,400 KM

BATTERY
TEST, CLEAN & CHECK FLUID LEVEL

REPLACE AS NEEDED

DRIVE BELT
INSPECT & ADJUST

REPLACE AS NEEDED

TIRES
INSPECT CONDITION & PRESSURE

EXHAUST SYSTEM
INSPECT & CLEAN

INSPECT FOR LEAKAGE OR CARBON BUILD UP AT JOINTS

INSPECT & CLEAN SCREEN TYPE SPARK ARRESTOR

AIR FILTER

A clogged air filter can restrict air flow to the engine which can lead to reduced engine performance and shortened engine life.

DRIVE BELT

Polaris Engineered belts deliver unmatched performance for your off-road vehicle. Developed and tested on all our engines for all environments and conditions. Check your belt for delamination, hour glassing and glazing.

OUR INVESTMENT

- 64,000+ km of field testing
- Thousands of dyno hours
- 18+ months of development (13,000+ design hours) per belt
- 1,500+ vehicle validation hours
- Collaboration with powertrain and clutch engineers

YOUR ADVANTAGE

- No clutch recalibration
- Less wear and tear due to heat
- Ensure maximum vehicle performance
- More time riding, less time wrenching
- Produced in collaboration with powertrain and clutch engineers to ensure a perfect fit, maximum performance and ultimate durability

BREAK-IN PERIOD

- Use lower gear (if available) while varying speeds and avoid wide open throttle for 8-16 km
- If no low gear is available, vary at moderate speeds while avoiding wide open throttle for 80 km

OIL FILTER

Change oil filters with every oil change to provide the best engine protection and keep the engine operating at peak performance.

24 MONTHS

200 HRS | 2,000 MI / 3,200 KM

ENGINE OIL
CHANGE

TRANSMISSION FLUID
CHANGE

GEARCASES
CHECK OIL LEVEL

BRAKE PADS & FLUID
INSPECT & CLEAN
REPLACE AS NEEDED

SPARK PLUGS
REPLACE

EXHAUST SYSTEM
INSPECT & CLEAN

INSPECT FOR LEAKAGE OR CARBON BUILD UP AT JOINTS

INSPECT & CLEAN SCREEN TYPE SPARK ARRESTOR

30 MONTHS

250 HRS | 2,500 MI / 4,000 KM

ENGINE OIL
CHANGE

BATTERY
TEST, CLEAN &
CHECK FLUID LEVEL
REPLACE AS NEEDED

DRIVE BELT
INSPECT & ADJUST
REPLACE AS NEEDED

GENERAL LUBRICATION
ALL FITTINGS,
PIVOTS, CABLES, ETC.

EXHAUST SYSTEM
INSPECT & CLEAN

INSPECT FOR LEAKAGE OR CARBON BUILD UP AT JOINTS

INSPECT & CLEAN SCREEN TYPE SPARK ARRESTOR

36 MONTHS

300 HRS | 3,000 MI / 4,800 KM

ENGINE OIL
CHANGE

AIR FILTER
INSPECT
REPLACE AS NEEDED

GEARCASES
CHECK OIL LEVEL

SPARK PLUGS
REPLACE

EXHAUST SYSTEM
INSPECT & CLEAN

INSPECT FOR LEAKAGE OR CARBON BUILD UP AT JOINTS

INSPECT & CLEAN SCREEN TYPE SPARK ARRESTOR

*This is a sample maintenance schedule and is not intended for use in your specific vehicle. Please reference and use your owners manual to ensure proper maintenance and vehicle care.

FOR A COMPLETE MAINTENANCE SCHEDULE, CHECK YOUR OWNER'S MANUAL

OIL

PS-4 FORMULATIONS BEST PROTECTION, BEST PERFORMANCE

Our PS-4 engine oils provide ultimate performance and protection, they're formulated with exclusive additives to keep engines clean from deposit buildup. These powersports-grade full synthetic oils help maximize power and protect your engine for the long term.

PS-4 5W-50 FULL-SYNTHETIC OIL

Optimal for ambient operating temperatures of -40° C to 38° C

1 L	4 L	25 L	60 L	200 L
502484	502485	502486	502487	502488

PS-4 0W-50 **EXTREME** FULL-SYNTHETIC OIL

Optimal for ambient operating temperatures of -43° C to 54° C.

1 L	4 L	25 L	60 L	200 L
503220	503221	503233	503236	503235

PS-4 5W-50

OIL CHANGE KITS

These convenient kits include everything needed including filter and oil volume per vehicle

PART NUMBER	VEHICLE FITMENT
502541	SINGLE 570, TWIN 600, TWIN 700, TWIN 800
502543	RANGER/RZR 900/1000
502542	SPORTSMAN 550/850/1000

POLARIS INVESTS IN EACH OIL AT & ABOVE THESE LEVELS

**12+ DEDICATED
TEAM MEMBERS**
FOCUSED ON POLARIS OIL

**18+
MONTHS**
DEVELOPMENT & TESTING

**76,000+
HOURS**
DYNO TESTING

**3.5 MILLION+
KILOMETERS**
FIELD TESTING



POLARIS
EXTREME
SYNTHETICS

PS-4 EXTREME SYNTHETIC 0W-50

- Our best extreme high and low temp formula, excellent for high temperatures and racing, even at temps of 54°C, plus easier cold starting even below -42°C
- Expect the best in wear protection thanks to premium PAO and ester base stocks combined with a balance of moly and ZDDP additives
- Polaris exclusive clean engine additive system reduces deposits and carbon build-up for peak performance and power

THE BEST PROTECTION, MAXIMUM PERFORMANCE

- Powersports grade full synthetics provide long lasting engine protection
- At least 40% improved wear protection compared to all aftermarket oils tested (see engine wear test chart)
- Polaris exclusive clean additive system
- At least 50% less deposits than all aftermarket oils tested (see deposit test chart)
- Cleaner engine with less deposits means consistent maximum power and performance

WIDEST VISCOSITY FOR ULTIMATE PROTECTION



ENGINE WEAR TEST

LOWER NUMBER = LESS ENGINE COMPONENT WEAR
LESS WEAR ON PARTS MEANS LONGER ENGINE LIFE

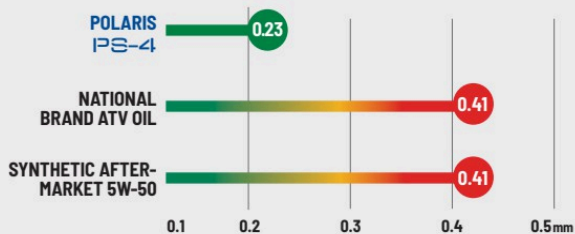

ASTM D4172. In 3rd party testing against 9 competitive products Polaris had 40% or better wear protection compared to all of the tested products. Numbers represent mm of wear scarring measured. Test measures wear at contact points, wear scar is measured for its length and width (in units of mm). Lower wear numbers mean better wear protection and friction reduction.

DEPOSIT TEST

LOWER DEPOSITS = MAXIMUM POWER

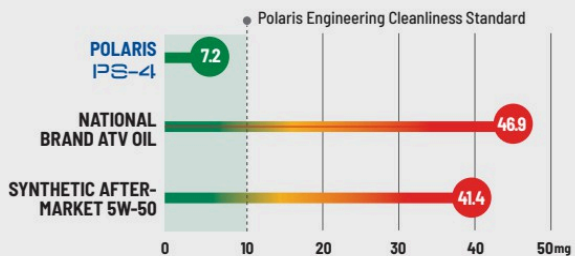

ASTM D6335. In 3rd party testing against 9 competitive products Polaris PS-4 had less than half the deposits compared to the next closest product. No other tested products met Polaris Engineering standards for deposit cleanliness. Test measures mass of deposits in mg in high temp, high stress test cycles. Higher deposits will impact engine power and performance.

MAINTENANCE FLUIDS



DOT 4 BRAKE FLUID

A high-quality brake fluid designed for use in Polaris hydraulic brakes.

» 250 mL • 502526



AGL

Protects transmission components against wear, corrosion, oxidation and foam in transmissions. Unique viscosity provides all-season performance including cold flow protection.

» 1L • 502505

» 25 L • 502507

» 200 L • 502508

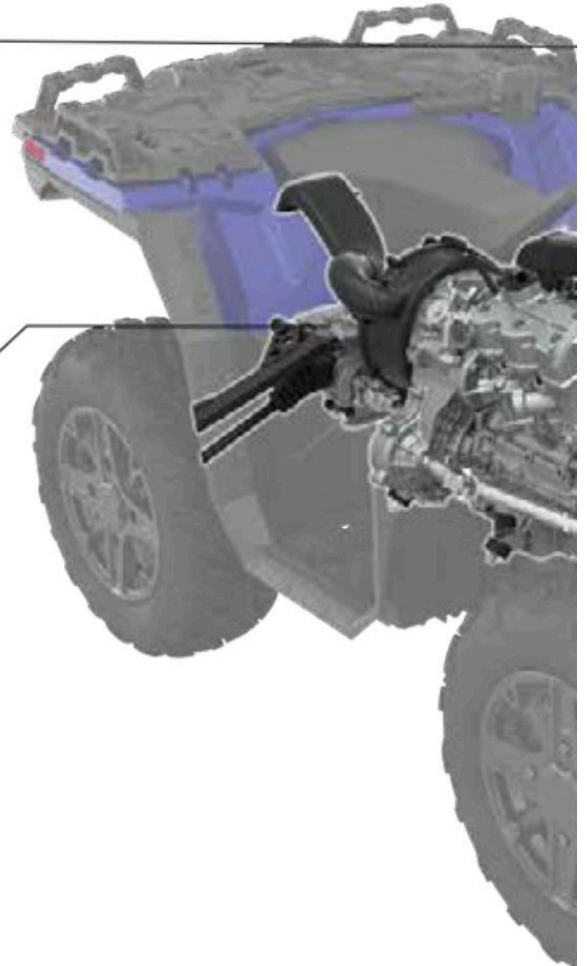

PREMIUM GAS SHOCK OIL

» 1L • 502518



ALL-SEASON GREASE TUBE

Specialized water-resistant lubricant

» 400 g • 502538



ANGLE DRIVE FLUID

Provides maximum protection in high-torque/high-pressure conditions. Reduces wear, corrosion and oxidation in rear angle drives

» 1L • 503320

» 25 L • 503318

» 202 L • 503317

SPORTSMAN, RANGER, RZR
ANGLE DRIVE GEAR CASE SYSTEMS

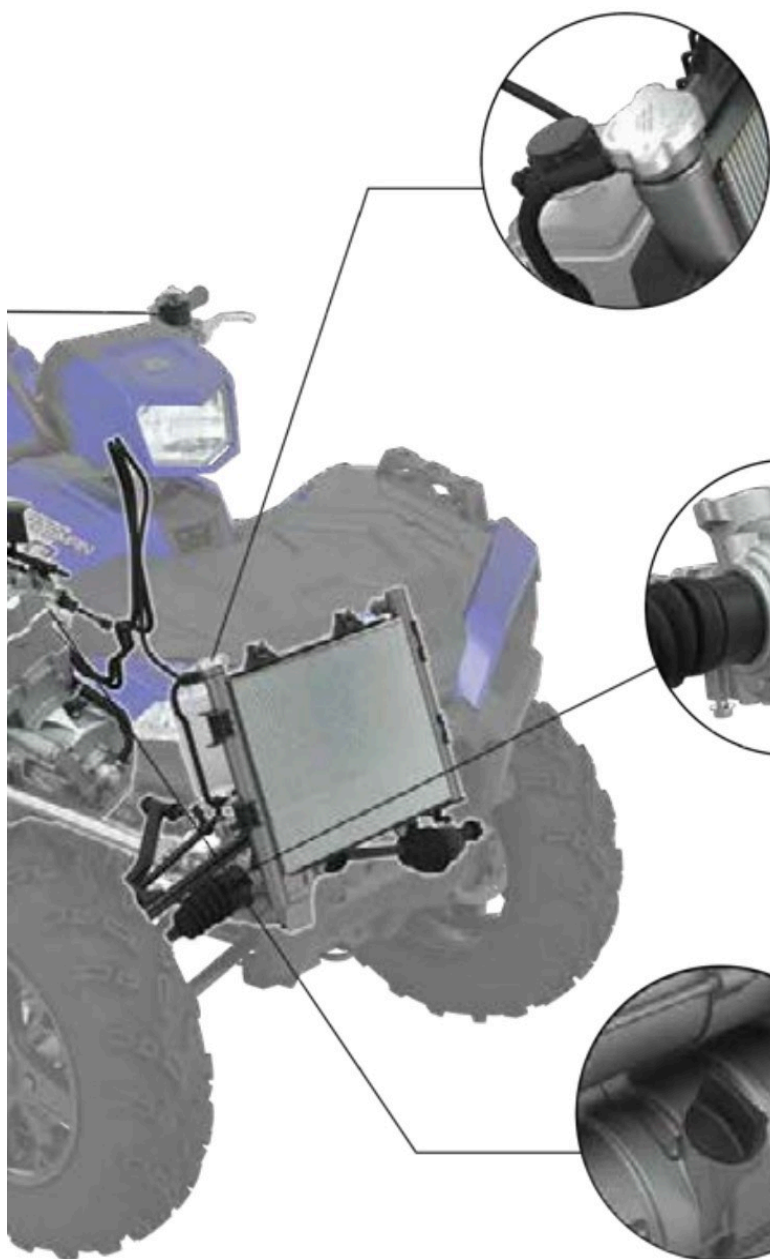

ANTI-FREEZE

Prevent corrosion on metal components, eliminate scaling and maximize cooling system performance.

- » 1 L • 502566
- » 25 L • 502567
- » 206 L • 502568



DEMAND DRIVE FLUID

Proprietary formulation prevents clutch slippage and chatter and reduces component wear and corrosion.

- » 1 L • 502563
- » 25 L • 502564
- » 200 L • 502565



ENGINE OIL

Maximum protection for your 4-cycle engine.

- » SEE P. 56



CARBON CLEAN

Ultimate fuel and injection system cleaner

- » 125 mL • 502528



FUEL STABILIZER

Fuel Stabilizer prevents ethanol corrosion and stabilizes fuel for up to 2 years. Dual-antioxidant formula protects against gum and varnish for easy starting.

- » 125 mL • 502519

HD HEAVY DUTY PARTS

All Polaris parts are developed and tested to help you get the most out of your ride. We're taking the passion of our riders, workers and outdoor enthusiasts to the next level with HD Parts.

Engineered and designed for:

- Greater durability
- Enhanced performance
- Greater wear and tear capabilities
- All weather conditions



OIL FILTERS

The advanced synthetic material built into these filters offers the highest debris holding capacity, maintains oil flow and maximizes performance.

OE	HD HEAVY DUTY PARTS
2520799	2522498
2540086	2522485



DRIVE BELTS

The enhanced rubber material compound in these belts keep them cool in extreme heat, while our patented cord treatment process maximizes the transfer of horsepower to the ground for those customers hauling heavy loads.

OE	HD HEAVY DUTY PARTS
3211149	3212326
3211077	3212328
3211113	3212332
3211160	3212331



WHEEL BEARINGS

Fully sealed for added protection against intrusions. Made of a higher grade steel for extended life in extreme conditions.

LOCATION	OE	HD HEAVY DUTY PARTS
FRONT WHEEL BEARINGS	3514822	3515090
	3514634	3515088
REAR WHEEL BEARINGS	3514917	3515087



WHEELS & TIRES

Class leading durability for off-road performance and traction for confident driving in extreme conditions.

- » 1524022-458 • HD WHEEL - 14x7
- » 5457498-458 • HD WHEEL CENTER CAP
- » 5415756 • PRO ARMOR XD-K FRONT
- » 5415757 • PRO ARMOR XD-K REAR

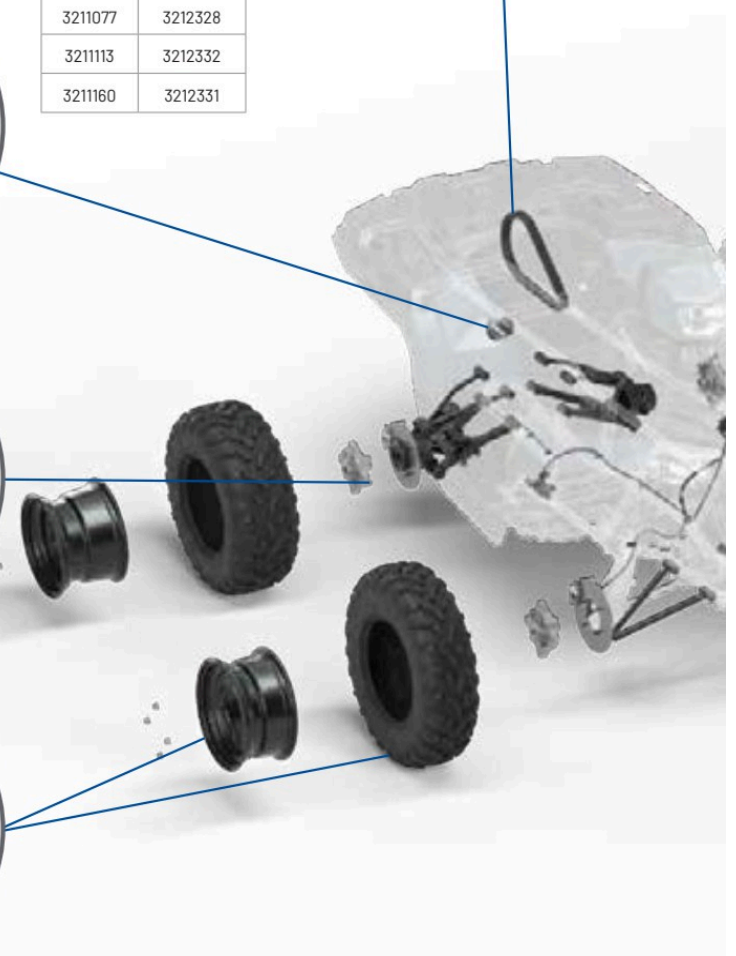

Claims made based off testing and performance of Polaris HD Parts against standard OEM parts made by Polaris and competitor brands under normal use.



BUSHING KITS

Easily update the entire front and rear suspension.

» 2830562 (SHOWN)

570 EFI '16-'20, 570 EFI X2 '16-'20, 570 EFI TOURING '16-'20, 570 EPS UTILITY '20, 450 HD '16-'20, 450 UTILITY '20

» 2830563

570 SP '16-'19, 570 PREMIUM '19, 570 SP TOURING '16-'20

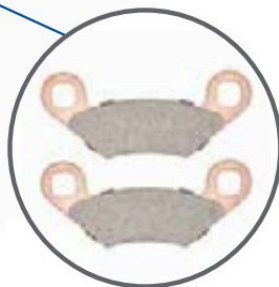

BUSHINGS

The advanced material compound of the bushings enables tighter tolerances to reduce overall wear on the system, while the superior triple lip sealing prevents intrusion of the elements.

LOCATION	OE	HD <small>HEAVY DUTY PARTS</small>
FRONT UPPER BUSHINGS	5439874	1543367
FRONT LOWER BUSHINGS	5439874	1543367
	5436973	1543326
REAR UPPER BUSHINGS	5439874	1543367
	5438895	1543326
REAR LOWER BUSHINGS	5439874	1543367
	5436973	1543326

CV BOOT KIT

TPE rubber compound for maximum puncture and tear resistance, includes (1) boot, grease and clamp to replace OE stock part. Provides increased durability for riding in extreme conditions.

OE	HD <small>HEAVY DUTY PARTS</small>
2204102	2209922
3236165	2209923

BRAKE PADS

Engineered to provide longer life and better stopping power while riding in extreme conditions.

LOCATION	OE	HD <small>HEAVY DUTY PARTS</small>
FRONT	2205949	2208933
FRONT/ REAR	2202413	2208934
	2202412	2208935

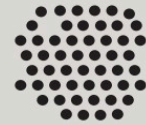

SAND



MUD



WATER



EXTREME COLD



EXTREME HEAT UP TO 54° C



HEAVY PAYLOADS



EXTENDED LIFE

SERVICE PARTS

POLARIS ENGINEERED SERVICE PARTS DELIVER UNMATCHED PERFORMANCE AND FIT FOR YOUR OFF-ROAD VEHICLE.

All service parts are engineered specifically for your machine. Which means everything is designed, tested and perfected to maximize the life of your ride. Getting Polaris Engineered parts is a decision that pays off in the long run, because it ensures there is a long run.

VISIT YOUR POLARIS DEALER TO SHOP FOR SERVICE PARTS.

OVER
100,000
PARTS
AVAILABLE!



FOR THE LIFE OF YOUR RIDE

Maintenance is the key to keeping your Polaris off-road vehicle performing at its peak. Items like belts, lubricants, and batteries represent only a few of these critical items engineered specifically by Polaris.



POLARIS ENGINEERED DRIVE BELTS

TESTED, PERFECTED

We test each belt on the intended vehicle – we don't just try to make an existing belt "just work".

– Amery Kuhl, Polaris CVT System Engineer

OUR INVESTMENT

- 32,187 km of field testing
- Thousands of dyno hours
- 18+ months of development (3,000+ design hours) per belt
- 1,200+ vehicle validation hours
- Collaboration with powertrain & clutch engineers

YOUR ADVANTAGE

- No clutch recalibration
- Less wear & tear due to heat
- Ensure maximum performance of your vehicle
- More time out riding, less time wrenching

**OUR INVESTMENTS ENSURE POLARIS BELTS
OUTPERFORM YOUR EXPECTATIONS.**

KEEP IT CLEAN

CLEAN

ALL-PURPOSE CLEANER

- Professional cleaner, which is formulated with a low pH-value. The product spreads well on surfaces and adheres on them for effective cleaning action. Perfectly compatible with rubber, plastic and painted surfaces. The formulation is biodegradable.

» 500 mL • 502309

SHINE

INSTANT SHINE & DETAILER

- The INSTANT SHINE AND DETAILER is developed for cleaning action without water. Removes insects, dust and dirt with almost no effort. Applicable for plastics, visors, windscreens, paint and metal. The wipe and shine formulation makes surfaces shine, works water repellent and also has an antistatic effect. Perfect for customers living in urban areas with no access to water, for bike trips or showroom bikes.

» 500 mL • 502546



BRING IT EVERYWHERE

TRAILERING



CALIBER RAMP PRO

- Designed for ATVs and UTVs up to 127 cm wide
 - Integrated grip glides for ultimate traction
 - Folding sides for easy transportation and storing
- » 132 cm x 229 cm • 2884576



ALUMINUM ARCHED LOADING RAMPS

- Capacity for up to 1,361 kg
- » 193 cm x 30.5 cm • 907 kg • 2875384
 » 224 cm x 30.5 cm • 1,361 kg • 2875386



LIGHTWEIGHT TRI-FOLD RAMPS

- Ramp folds up for transport
 - Capacity for up to 680.7 kg
 - Safety straps included
- » 183 cm x 130 cm • 2875385
 » 208 cm x 130 cm • 2875860



FOLDING ALUMINUM ARCHED RAMPS

- Ramp folds up for transport
 - Up to 680 kg total capacity, 340 kg per individual ramp
 - Safety straps included
- » 224 cm x 30.5 cm • 2875387

COVERS

TRAILERABLE COVER

- » 2876614
- SPORTSMAN 450/570,
- SPORTSMAN 850/1000
- REPLACEMENT STRAP 2871912

- » 2877999 (SHOWN)
- ALL SPORTSMAN TOURING
- REPLACEMENT STRAP 2871912



CV BOOT REPAIR KIT*

FIX ON THE GO | TEMPORARY COVERAGE

- A quick trail-side fix to increase trail time
- The flexible and durable boot material expands over a cone tool for CV boot repairs, without disassembling CV axles
- Universal fit - works as a temporary fix for most powersports axles
- All components fit inside the cone, and a cover is provided for compact durable storage
- Easily fits in a cargo box, attached to the roll cage, in the glovebox or many other storage locations



Items shown are contained inside cone

ATV CV BOOT REPAIR KIT

Kit includes the following items:

- (1) Expandable CV Boot
 - (1) Reusable Cone Tool
 - (2) CV Boot Clamps
 - (1) Tube of Silicone Lube
 - (1) Grease Packet
 - (1) Cone Cover
- » 2830528

ATV TRAIL BOOT ONLY

» 2830529

UTV

- » CV REPAIR KIT 2830526
- » TRAIL BOOT ONLY 2830527

HOW TO INSTALL

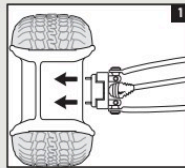

Remove wheel and axle nut.

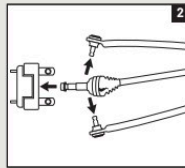

Remove brake caliper, hub, tie rod and upper and lower ball joints.

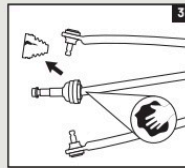

Remove old boot and clean joint.

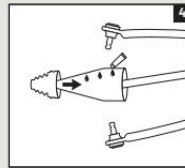

Spread silicone lube on entire cone tool. Slide boot over cone tool, large end first. See package for outer boot instructions.

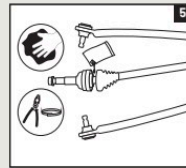

Empty the bag of grease into the CV joint/boot, clean sealing points and install clamps.

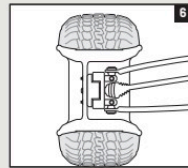

Reassemble tie rod, ball joints, brake caliper, axle nut, tire and wheel.

Refer to your service manual for further instructions and torque specifications.
*Designed for temporary CV boot repair. Purchase the OEM CV Boot for a permanent repair.

HITCHES



HITCH WITH 5 cm BALL

- 3:1 Hitch: ball, hook and pin design
 - Rust resistant steel with powdercoat finish
 - Removable ball, HD 1.6 cm pin and clip
- » 5 cm x 5 cm RECEIVER • 2830522
» 3 cm x 3 cm RECEIVER • 2830523



4.8 cm BALL

- 4.8 cm replacement ball for hitch
 - Designed to work with 3:1 Hitch
- » 2830524



RECEIVER HITCH

- » 5 cm RECEIVER TONGUE 2875320



TRAILER BALL 1.9 cm SHANK

- » 4.8 cm BALL • 2877602
- » 5 cm BALL • 2877603

STRAPS & ROPES



RECOVERY STRAP

- 5 cm x 9.1 m
 - 8,165 kg maximum load, 4,082 kg maximum vehicle weight
 - Comes with carry bag
- » 2884033



RATCHET STRAP

- 3.8 cm x 4.6 m straps, 2 pack
 - Heavy duty webbing
 - 2,495 kg maximum load, 831 kg working load
- » 2884031



RATCHET STRAP

- 5 cm x 6.1 m Ratchet Straps
 - Heavy duty webbing, floating D-rings, double J-hooks
 - 4,536 kg maximum load, 1,497 kg working load
- » 2884032



SHOCK STRAPS

- 3.8 cm 1,361 kg breaking strength
 - Keeps tension on tie-down straps to secure load, 2 Pack
- » 3.8 cm x 4.6 m • 2883296
» 3.8 cm x 2.1 m • 2883295



APPAREL

FIT FOR ANY ADVENTURE. For outdoor enthusiasts looking for gear that's purposefully built to stand up to the fun and challenging experiences Polaris vehicles enable. Each piece of apparel and equipment bearing the name Polaris is crafted by outdoor enthusiasts, for outdoor enthusiasts. They are a badge of honor – representing what the Polaris brand stands for – a passion to simply be outside doing what you love.



APPAREL

RACING COLLECTION

JERSEYS & GLOVES
& HEATED APPAREL

HELMETS & GOGGLES

MENS APPAREL

BALL CAPS & BEANIES

WOMENS APPAREL

HOME
& COLLECTIBLES

RACING COLLECTION



HELMET

- Polycarbonate shell
- Removable & washable lining
- Double lens system with integrated sun visor
- Quick release micrometric adjustment system

NEW Black Matte | XS-2XL | 2802408
 White Gloss | XS-2XL | 2802311
 Dark Gray Matte | XS-2XL | 2802312

ECE 22.06



- Weight: 1450 g (+/-50 g)
- 1 shell and 2 EPS: XS-M, L-XXL
- ECE 22-06 approved



BOOTS

- Waterproof and breathable lining
- Full-grain oil treated leather upper
- Specific ATV double density compound rubber sole
- Adjustable Velcro® closure
- Replaceable/adjustable plastic buckles
- Anti-bacterial replaceable footbed
- CE-approved motorcycle boots EN 13634:2017

Black | EU39 - 47 | 2802313
 Brown | EU39 - 47 | 2802314



SPORT JACKET

- Light and water repellent jacket
- Ideal for ATV and SxS ride in wet weather
- 2 zipped pockets on the outside and 2 inside pockets
- Laser cut under the arms for better ventilation

Black | XS-4XL | 2802409



SPORT PANTS

- Light and water repellent pant
- Ideal for ATV and SxS in wet weather
- Ergonomic cut and stretch to gain comfort
- 1 zipped pocket
- Belt adjustment with micrometric buckle

Black | XS-4XL | 2802410



TECHNICAL SHIRT

- 100% polyester
- Indelible sublimated graphics
- Hemmed edging
- Lycra cuffs and collar

Men's | Black | S-3XL | 2802404
 Women's | White | S-2XL | 2802405



SAFETY GLOVES TOUCH



- CE-approved motorcycle glove EN 13594:2015
- Touch screen compatible
- Silicon print on fingers to improve grip
- Neoprene cuff with Velcro® tightening
- Reinforcements patches for safety and comfort

Khaki | S-3XL | 2802309
 Black | XS-7, 3XL-13 | 2802103



NEO GLOVES



- CE-approved motorcycle glove EN 13594:2015
- 100% synthetic neoprene glove
- Touch screen compatible
- Knuckle protected
- Reinforcements patches for safety and comfort

Black | XS-7, 3XL-13 | 2802310



SF TECH GLOVES TOUCH



- CE-approved motorcycle glove EN 13594:2015
- Touch screen compatible
- Knuckle-protected
- Silicon print on fingers to improve grip
- Neoprene cuff with Velcro® tightening
- Reinforcements patches for safety and comfort

Khaki | S-3XL | 2802308
 Black | XS-7, 3XL-13 | 2802102



TECHNICAL JACKET

- Water-resistant jacket
- Ultra-light thanks to polyester ripstop and softshell for optimal comfort
- Ventilated lining
- Hydration hose outlet
- Zip ventilation system on body and back

Black | S-3XL | 2802301



TECHNICAL PANTS

- Water-resistant pants
- Ultra-light thanks to polyester ripstop, softshell and 1000-D Cordura stretch fabric on the back for optimal comfort
- 2 cargo type pockets
- Zip ventilation system
- Zip and Velcro® adjustment at the bottom of the pants

Black | S-3XL | 2802302



NEW WATERPROOF JACKET

- 100% polyester 2,5 Layer stretch fabrics
- PU membrane waterproof and breathable 3000 mm / 3000 gr
- All seams taped and WR main zipper
- Adjustable hood
- Ventilation system on back to improve ventilation

Black | S-3XL | 2802403



PUFFY JACKET

- Top body and shoulder polyester woven 3000 mm/3000 gr + welded quilting
- Lower body nylon 380T downproof
- 80gr padding
- Inner elastic bottom tightening
- Two external pockets with easy-grab puller

Black | S-3XL | 2802303



PADDED JACKET

- Shoulder and hood softshell waterproof and breathable 3000 mm/3000 gr
- Lower body and sleeve, polyester woven waterproof and breathable 3000 mm/3000 gr
- Quilted lining with 80 gr padding
- Elasticized lower body tightening
- Two external pockets with easy-grab puller

Black | S-3XL | 2802306



RACING PARKA

- Waterproof and breathable 3000 mm/3000 gr
- Quilted lining with 80 gr padding
- 2 upper body outer pockets and 2 bottom cargo pockets
- Sleeve pocket with lazer holes
- +TPU welded film on zipper

Black | S-3XL | 2802307



BODYWARMER

- Upper body and side panels in softshell waterproof and breathable 3000 mm/3000 g
- Lower body nylon downproof
- Padding 80 g
- Two external pockets with easy-grab puller

Khaki | S-3XL | 2802304
Black | S-3XL | 2802101



RACING SOFTSHELL

- Softshell waterproof and breathable 3000 mm/3000 g
- Removable hood
- Four external pockets with easy-grab puller

NEW Women's | Black | S-XL | 2802402
Men's | Khaki | S-3XL | 2802305
Men's | Black | S-3XL | 2802003



HYBRID JACKET

- Sleeves in softshell waterproof and breathable 3000 mm/3000 g
- Body nylon downproof
- Padding 80 g
- Three external pockets with easy-grab puller

NEW Khaki | S-3XL | 2802401
Black | S-3XL | 2802004

JERSEYS & GLOVES



OFF-ROAD RIDING JERSEYS

Mesh ventilated panels for maximum airflow.
Elastic sleeves with non-restrictive cuffs.

OFF-ROAD RIDING GLOVES

Adjustable wrist closure for a custom fit.
Silicon finger grips and neoprene knuckle protection.
Gloves are not CE-approved.



	SIZE	 N/A	 N/A				
		A RED	B LIME/OLIVE	C BLACK	D ORANGE	E TEAL	F BLUE
ADULT JERSEY	S-3XL	2864637	2864638	2862718	2862719	2862720	2862722
GLOVES	S-3XL	2864635	2864636	2862726	2862729	2862727	2862728
YOUTH JERSEY	S-XL	2864639	N/A	2862723	N/A	2862724	2862725

NECK GAITERS

Keep the sun off your neck and the dust off your face.
Stretchy and seamless material that is UPF 15-18 for sun protection and moisture-wicking.



- Blue | 2833138
- Camo | 2861948
- Black | 2861953
- Red Retro | 2861950
- Lime | 2861952

HEATED APPAREL

Keep warm even on the coldest days with Polaris Heated Apparel. By keeping the heat close to your body, you can stay out for a longer, more comfortable ride. The Polaris Heated Apparel lineup includes the Heated Vest, Heated Base Layers and a Heated Glove Liner for both men and women. Easily control your heat setting with the touch of a button.



WOMEN'S
Black | 2833036



MEN'S
Black | 2833022

HEATING ELEMENTS



UNISEX
Black | 2833044

HEATED VESTS

WARMTH WITH THE TOUCH OF A BUTTON

S-3XL

- Perfect for any outdoor activity
- Down-proof machine washable material with 160g of insulation for warmth with or without the heater turned on
- Powered by a small rechargeable battery (included) that can also be used to charge a cellphone; battery not machine washable, remove prior to washing
- Easily adjust between four heat settings for changing weather conditions with built-in buttons

HEATED GLOVE LINER

KEEP YOUR HANDS WARM ON FROSTY DAYS

S-3XL

- Designed to fit under all Polaris riding gloves for an extra layer of warmth to keep you out riding longer
- Easily adjust your heat level by pressing a button on the bottom part of the glove



HEATING ELEMENTS

WOMEN'S
Top | 2833033
Bottom | 2833034

MEN'S
Top | 2833031
Bottom | 2833032

HEATED BASE LAYERS

ADJUSTABLE HEAT CLOSE TO YOUR BODY, MAXIMUM COMFORT IN CHANGING CONDITIONS

S-3XL

- Intended for use as a base layer
- Features lightweight, moisture-wicking fabric to give you the most comfortable layering to wear on all of your cold weather adventures, on or off the trail
- Includes multiple heat panels for evenly distributed heat for maximum warmth and comfort
- Powered by a small rechargeable battery (included) that can be used to charge a cellphone; battery not machine washable, remove prior to washing
- Easily adjust between four heat settings for changing weather conditions with built-in buttons

HEATED APPAREL REPLACEMENT BATTERY PACK

- Compatible with Polaris Heated Base Layer Tops, Bottoms & Vests
- Includes: 7.4V Lithium-Ion Battery with two 7.8V chargers (110V wall and 12V port)

2864582



HEATED GLOVE LINER REPLACEMENT BATTERY PACK

- Compatible with Polaris Heated Glove Liners
- Includes: two 7.4V Lithium-Ion Batteries, one 100-240V charger

2864583



HELMETS



CARBON FIBER
BLACK
S-2XL | 2833158

509 FOR
POLARIS FIDLOCK. IGNITE

DELTA V COMMANDER

NO LONGER A HELMET, IT'S A COCKPIT

SHELL

- Carbon fiber
- Lightweight polycarbonate

WEIGHT

- Up to 1,832 g

FEATURES

- The Delta V Commander features an integrated communication system, infinity style sealed IGNITE heated shield, and ergonomic design
- Features in-helmet JBL® speakers for audio and an integrated microphone to connect up to 14 users in a group with the best sound and noise cancellation for all your rides
- Venturi Vent Ducting, an integrated spoiler, and low-profile antennae keeps this helmet sleek, quiet, and fog-free all day on the trails
- 12-volt power input on left side powers shield, comms, and chase light with controls for bright, normal, and off positions
- Battery power for up to 10 hours of riding
- Connect via Bluetooth® to your music, phone, maps, and sled
- DOT/ECE 22.06 dual certified helmet shell and luxurious liner
- Fidlock® chinstrap for easy on and off



CARBON FIBER
WHITE
2833152

509 FOR
POLARIS FIDLOCK. IGNITE

DELTA V CARBON IGNITE

BUILT SPECIFICALLY FOR SUSTAINED LONG RIDES,
AT SPEED, IN COLD TEMPERATURES

S-3XL

SHELL

- Carbon fiber

WEIGHT

- Up to 1,807g

FEATURES

- Hand-laid carbon fiber construction for lightweight and durable performance
- Powered helmet – 12 volt power input on left side to power shield
- IGNITE heated shield is powered by your snowmobile's battery, and comes with all required connection cables
- Compatible with 509 12 volt power pack system, for 10 hours of riding
- Innovative Venturi Vent pulls moist air from helmet without cold wind coming into helmet
- 2 shell sizes, and dual density EPS for optimal fit
- Premium liner for a comfortable and quiet fit
- Ignite dual pane heated shield for fog-free performance
- DOT/ECE 22.06 dual certified helmet shell
- Fidlock® chinstrap for easy on and off



BLACK
S-3XL | 2833151



WHITE
S-3XL | 2833150



CARBON FIBER
BLACK
2833153



ORANGE/TAN
2864559

TENACITY 4.0

COMBINATION OF MODERN STYLE & PREMIUM PROTECTION WITH INCREDIBLE VALUE

XS-2XL

SHELL

- Shock-resistant, injection-molded thermoplastic

WEIGHT

- 1,500g

FEATURES

- Through-flow, full-helmet ventilation
- ProClip quick release chin strap allows you to fasten the chin strap in seconds
- Removable breath box and removable, washable liner
- Tool-less adjustable roost shield
- DOT- and ECE 22.06-approved



BLACK/LIME
2864560

RADIANT GREEN
2833142

BLACK
2861557

BLACK/GRAY
2861558

WHITE/RED
2861561

BLUE
2833143

GOGGLES



NEW
OLIVE/LIME
2864546

509 KINGPIN CE

PREMIUM MATERIALS, ATTRACTIVE PRICE

FEATURES

- Built for off-road, the oversized spherical lens delivers optimal peripheral vision
- Metal tear-off posts provide strength and durability
- Quick-change technology allows you to run the best lens tint for conditions



STEALTH
2862560



BLUE
2862562



NEW
ORANGE
2864545

509 MX6 CE

SUPER WIDE FIELD OF VIEW, ENGINEERED FOR DIRT

FEATURES

- PC outer lens with anti-scratch coating, and internal anti-fog coating
- Outriggers with latch system for quick lens change
- 45mm strap with silicone to hold strap in place



BLACK
2862557



RED/BLACK
2862558

MEN'S APPAREL



BLUE
2864518



GRAY/RED
2833029



CYPRESS
2864517



CAMO
2861543



BLUE
2833028



BLACK
2861434

FORCE PUFFER JACKET

PACKABLE JACKET OFFERS LIGHTWEIGHT PROTECTION & INCREDIBLE WARMTH

S-3XL

- 140g 3M™ Thinsulate®
- Two external hand pockets, one internal media pocket
- Rugged YKK® zippers
- Compactable into travel pocket

SOFTSHELL JACKET

VERSATILE LIGHTWEIGHT JACKET THAT'S PERFECT FOR EVERYDAY WEAR

S-3XL

- Casual jacket armed with rugged and warm features for everyday wear
- Superior DWR prevents precipitation from saturating the jacket's exterior
- Lined with soft fleece for warmth
- Removable hood and underarm venting, three external pockets and one internal chest pocket



BLACK/GRAY
2864524



RED
2833026



BLUE/ORANGE
2862567



BLUE
2864525



BLACK/LIME
2833024



TAN
2862450

TITAN MID-LAYER

VERSATILE MID-LAYER CAN BE WORN ALONE OR AS AN EXTRA LAYER

S-3XL

- 319g Polartec™ Thermal Pro® Rib Sweater provides great warmth
- Breathable material moves sweat to the outer surface
- Nylon overlay is comfortable and light

NORTHSTAR MID-LAYER

EXTREMELY WARM YET BREATHABLE MID-LAYER, PERFECT FOR RIDING

S-3XL

- 280g of breathable fleece for added warmth
- Offers durable protection against the elements with a wear-resistant polyester face and wind-block layer on chest
- Designed to fit under outer shell when riding



BLACK
2862569

WORK VEST

RUGGED & DURABLE VEST THAT'S IDEAL AS AN OUTDOOR LAYER S-3XL

- Made of durable nylon fabric to make it the ideal vest for work
- 80g 3M™ Thinsulate™ Insulation provides great warmth
- Vest comes with plenty of pockets to store your valuables



BLUE/GRAY
2864521

RED
2833030

BLACK/GRAY
2862565

CAMO
2862572

REVOLVE VEST

REVERSIBLE

DURABLE & WARM REVERSIBLE VEST OFFERS TWO STYLES IN ONE S-3XL

- Durable windbreak outer fabric helps protect from the elements
- 140g 3M™ Thinsulate™ insulation keeps you warm in cold weather



LIGHT GRAY
2833110

GRAY
2862521

NAVY
2862523

ADAPT QUARTER-ZIP

EXTRA LIGHT MID-LAYER WITH A COMFORTABLE FIT S-3XL

- Versatile use both on and off the trail
- The polyester and spandex blend enables a flexible fit



CYPRESS
2864523

DARK BLUE
2864522

ORANGE
2833025

GRAY
2862576

BLUE
2861443

TECH QUARTER-ZIP

FLEECE LINED MID-LAYER FOR ESSENTIAL WARMTH WHILE RIDING WITH THE STYLE & COMFORT TO WEAR ANYWHERE S-3XL

- Fleece-lining keeps you cozy and warm
- Move freely with four-way stretch material
- Contoured, slim fit

MEN'S APPAREL



UPF HOODIE TEE

Blue | S-3XL | 2833072
 Gray | S-3XL | 2833073

ASCENT HOODIE

Black | S-3XL | 2864677
 Gray | S-3XL | 2864678
 Red | S-3XL | 2864679



CREW SWEATSHIRT

Green | S-3XL | 2864632
 Navy | S-3XL | 2864633
 Gray | S-3XL | 2833067
 Black | S-3XL | 2862488



JOURNEY HOODIE

Red | S-3XL | 2864535
 Cypress | S-3XL | 2864536
 Black | S-3XL | 2862489



PURSUIT HOODIE

Orange | S-3XL | 2864606
 Black | S-3XL | 2833076
 Green | S-3XL | 2833077



CAMO PURSUIT HOODIE

Camo | S-3XL | 2862494



ROGUE HOODIE

Blue | S-3XL | 2864587
 Black | S-3XL | 2833062
 Navy | S-3XL | 2833063



PLAID FLANNEL SHIRT

Blue | S-3XL | 2864671
 Cypress | S-3XL | 2864672



BACK

ADVENTURE LONG SLEEVE

Gray | S-3XL | 2833089
 Black | S-3XL | 2833090



ICON EDGE LONG SLEEVE

Gray | S-3XL | 2864682
 Blue | S-3XL | 2864683



BACK

PERFORMANCE LONG SLEEVE

Gray/White | S-3XL | 2833324
 Red | S-3XL | 2864600
 Royal Blue | S-3XL | 2833325
 Gray | S-3XL | 2833168
 Black | S-3XL | 2862507



ICON LONG SLEEVE

Blue | S-3XL | 2864591
 Navy | S-3XL | 2864590
 Lime | S-3XL | 2833083
 Black | S-3XL | 2861584



BACK

GRAPHIC TEE

Heather Gray | S-3XL | 2864612
 Dark Gray | S-3XL | 2833086
 Forest Green | S-3XL | 2833087



FLAG TEE

Navy | S-3XL | 2862500
 White | S-3XL | 2862582



HALF DOME TEE

Black | S-3XL | 2864616
 Olive | S-3XL | 2864617
 Navy | S-3XL | 2864618



PEAK GRAPHIC TEE

Blue | S-3XL | 2864684
 Black | S-3XL | 2864685



ASCENT TEE

Olive | S-3XL | 2864680
 Navy | S-3XL | 2864681

BALL CAPS



HALF DOME PATCH CAP

Black | 2864576
Tan | 2864577



METAL BADGE PANEL CAP

Cypress | 2864574
Black | 2864575



HEX PATCH COOLING CAP

Black | 2864571
Blue | 2864572
Gray | 2864573



ELLIPSE PATCH TRUCKER HAT

Purple | 2864563
Cypress | 2864562
Gray | 2833498
Black | 2833500
Navy | 2833499
Orange | 2833124



STAPLE CAP

Cypress | 2864568
Black | 2833127
Navy | 2833128



TONAL HAT

Orange | 2864564
Black/Red | 2833497
Navy | 2833496



JOURNEY CAP

Light Blue | 2864570
Black | 2833136
Blue | 2833137



LEATHER PATCH HAT

Cypress | 2864569
Black | 2833129
Gray | 2833130



HIGHLAND CAP

Red | 2864567
Navy | 2833126
Gray | 2833506

BEANIES



STAPLE BEANIE

Purple | 2864693
 Radiant Green | 2833121
 Gray | 2833122
 Black | 2833116
 Navy | 2833117

CORE BEANIE

Red | 2864695
 Olive | 2864696
 Blue | 2833114
 Black | 2862530
 Orange | 2862595

SWITCHBACK BEANIE

Olive | 2864694
 Blue | 2833115
 Black | 2862532
 Gray | 2862533



LOOSE FIT BEANIE

Olive | 2864708
 Fuchsia | 2864709
 Black/White | 2864710



MARLED CUFF BEANIE

Pink | 2864707
 Gray | 2864706



FAIR ISLE POM BEANIE

White | 2864701
 Teal | 2864702



SPACE DYE POM BEANIE

Blue | 2864703
 Pink | 2864704



FAIR ISLE TASSEL BEANIE

Black/White | 2864711



REMOVABLE POM BEANIE

Red | 2864705
 Black | 2833119
 Green | 2861513
 Gray | 2861514

APPAREL

RACING COLLECTION

JERSEYS & GLOVES
& HEATED APPAREL

HELMETS & GOGGLES

MENS APPAREL

BALL CAPS & BEANIES

WOMENS APPAREL

HOME
& COLLECTIBLES

WOMEN'S APPAREL



BLUE/GRAY
2864519



BLACK
2833041



RADIANT GREEN
2833040



BLACK
2861433



DEEP LAGOON
2864520

SOFTSHELL JACKET

VERSATILE LIGHTWEIGHT JACKET THAT'S PERFECT FOR EVERYDAY WEAR

S-3XL

- Casual jacket armed with rugged and warm features for everyday wear
- Superior DWR prevents precipitation from saturating the jacket's exterior
- Lined with 280g of soft fleece for warmth
- Removable hood and underarm venting, three external pockets and one internal chest pocket

FORCE PUFFER JACKET

PACKABLE JACKET OFFERS LIGHTWEIGHT PROTECTION & INCREDIBLE WARMTH

S-3XL

- 140g 3M™ Thinsulate®
- Two external hand pockets and one internal media pocket
- Rugged YKK® zippers
- Compactable into travel pocket



BLACK
2862563

BLUE
2862564

WORK JACKET

WARM AND RUGGED JACKET THAT'S TOUGH FOR WORK & STYLISH FOR PLAY

S-3XL

- 100% nylon shell is coated with Durable Water Repellency to help keep you dry
- Built-in action back for increased range of motion
- 80g 3M™ Thinsulate® for added warmth with brushed flannel trim
- One inner and four outer pockets for storage



BLUE
2864530

RADIANT GREEN
2833042

BLACK/GRAY
2862458

TITAN MID-LAYER

VERSATILE MID-LAYER CAN BE WORN ALONE OR AS AN EXTRA LAYER

S-3XL

- 319g Polartec® Thermal Pro® Rib Sweater provides great warmth
- Breathable material moves sweat to the outer surface
- Nylon overlay is comfortable and light



PLAID FLANNEL SHIRT

Blue | S-3XL | 2864673
Teal | S-3XL | 2864674



STAPLE HOODIE

Blue | S-3XL | 2864607
Deep Lagoon | S-3XL | 2864608
Gray | S-3XL | 2833096
Black | S-3XL | 2833095



JOURNEY HOODIE

Purple | S-3XL | 2864537
Radiant Green | S-3XL | 2833098
Black | S-3XL | 2862515



UPF POLARIS HOODIE TEE

Pink | S-3XL | 2833102
Teal | S-3XL | 2833103



ADVENTURE CREW

Misty Blue | S-2XL | 2864602
Black/Radiant Green | S-2XL | 2833100
Green | S-2XL | 2833101
Dusty Rose | S-2XL | 2862513



BACK

ADVENTURE LONG SLEEVE

White | S-3XL | 2864611
Gray | S-3XL | 2833107
Navy | S-3XL | 2833108



CORE TANK

Black | S-3XL | 2833161
Gray | S-3XL | 2833160



FLAG TEE

Gray | S-3XL | 2833163
White | S-3XL | 2833162



VENTURE TEE

Heather Gray | S-3XL | 2864625
Turquoise | S-3XL | 2864626

HOME & COLLECTIBLES



POLARIS KEY RACK

30.5 cm x 20 cm | 2864718



POLARIS LED SIGN

61 cm x 26.7 cm | 2862736



POLARIS RACING LED SIGN

61 cm x 22.9 cm | 2862737



ALUMINUM SIGN

55.9 cm | 2860867



WOOD SIGN

61 cm x 26.7 cm | 2860866



POLARIS STEEL SIGN

91.4 cm x 35.6 cm | 2860868

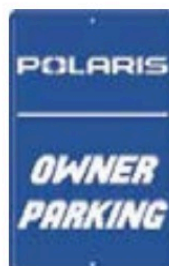

POLARIS PARKING SIGN

2869934



POLARIS FLAG

152 cm x 91.4 cm | 2869928



POLARIS RACING MUG

2864716



12 OZ CAMPER MUG*

2861612



23 OZ WATER BOTTLE*

2862685



15 OZ CAMPFIRE MUG*

2861613



POLARIS PVC COASTERS
2864715



POLARIS LOWBALL GLASSES WITH COASTERS (SET OF 2)
2864721



FLASK*
2860812



PREMIUM KOOZIE*
2860829



KICKBACK ROCKER*
■ ■ ■ Green | 2864816
Blue | 2862626



FREESTYLE ROCKER*
2862625



EASY CHAIR*
2862627



NEW PICO CHAIR*
2864817



QUICK-E-SEAT*
2862624



FOLDABLE TABLE
2861620



KEYCHAIN
2861614



LEATHER KEY CHAINS
Leather Loop | 2861615
Black Leather | 2861616



DECK OF CARDS
2860816



POLARIS NOTEBOOK
2860831



HITCH COVER
2861623



LICENSE PLATE HOLDER
2862687

*Not available in Europe

FORGE YOUR OWN PATH



Availability varies by market. Check your local dealer for availability. Images taken on private land. The use of vehicles in similar environments in your jurisdiction may be prohibited per locally applicable laws and regulations. Campfires in similar environments in your jurisdiction may be prohibited per locally applicable laws and regulations. Keep your campfire safe, and make sure you can control it at all times. Know your locally applicable laws and regulations. Crossing water in similar environments may be prohibited in your jurisdiction.

Warning: Polaris Off Road vehicles can be hazardous to operate and are not intended for on-road use. Driver must be at least 16 years old with a valid driver's license to operate. All riders should always wear helmets, eye protection and protective clothing and footwear. Read, understand and follow your owner's manual. Ride within the limits of your own abilities and never engage in stunt or exhibition driving. Never ride under the influence of drugs or alcohol. All riders should take a safety training course.

Unless noted, trademarks are the property of Polaris Industries Inc. 3M® and Thinsulate® are registered trademarks of 3M Company. 509® is a registered trademark of Teton Outfitters, LLC. App Store® is a registered trademark of Apple Inc. Bluetooth® is a registered trademark of Bluetooth SIG, Inc. Caliber® is a registered trademark of Caliber, Inc. Facebook™ is a service trademark of Facebook, Inc. Fidlock® is a registered trademark of Fidlock GmbH. FOX® is a registered trademark of Fox Factory Inc. Google Play™ is a service trademark of Google LLC; and YouTube® is a registered trademark of GOOGLE LLC. GoPro® is a registered trademark of GoPro Inc. Instagram™ is a service trademark of Instagram, LLC. MORFLEX® is a registered trademark of FNA Group, Inc. NOCO Genius® is a registered trademark of The Noco Company. OGIO® is a registered trademark of Ogio International, Inc. Polartec® and Thermal Pro® are registered trademarks of MMI-IPCO, LLC. RIGID® is a trademark of JST Performance, LLC d/b/a Rigid Industries, LLC. Rockford Fosgate® is a registered trademark of Rockford Corporation. SMART BOARD® is a registered trademark of SMART TECHNOLOGIES ULC UNLIMITED LIABILITY CORPORATION CANADA. TEKVEST® is a registered trademark of 1181676 ONTARIO INC. Tiger Drylac® is a registered trademark of TIGER COATINGS GMBH & CO. KG. Velcro® is a registered trademark of VELCRO BVDA. Twitter™ is a registered servicemark of Twitter, Inc. WALKER EVANS RACING® is a registered trademark of Walker Evans Enterprises Incorporated. YKK® is a registered trademark of YKK Corporation. Fitment and availability are subject to change at any moment. Copyright © 2023 Polaris Industries Inc. All rights reserved.

POLARIS
Think Outside

MY24 SPTSMN APP ACC - EMEA